

Fast Recovery Epitaxial Diode (FRED) Module

MEK 350-02 DA

$V_{RRM} = 200\text{ V}$
 $I_{FAVM} = 356\text{ A}$
 $t_{rr} = 150\text{ ns}$

| V_{RSM} | V_{RRM} | Type |
|-----------|-----------|--------------|
| V | V | |
| 200 | 200 | MEK 350-02DA |

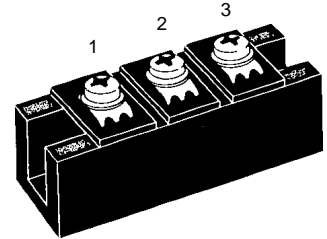
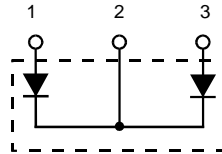

| Symbol | Test Conditions | Maximum Ratings | |
|--------------|---|-----------------|----------------------|
| I_{FRMS} | $T_C = 75^\circ\text{C}$ | 503 | A |
| I_{FAVM} ① | $T_C = 75^\circ\text{C}$; rectangular, $d = 0.5$ | 356 | A |
| I_{FRM} | $t_p < 10\ \mu\text{s}$; rep. rating, pulse width limited by T_{VJM} | 1800 | A |
| I_{FSM} | $T_{VJ} = 45^\circ\text{C}$; $t = 10\text{ ms}$ (50 Hz), sine | 2400 | A |
| | $t = 8.3\text{ ms}$ (60 Hz), sine | 2640 | A |
| | $T_{VJ} = 150^\circ\text{C}$; $t = 10\text{ ms}$ (50 Hz), sine | 2160 | A |
| | $t = 8.3\text{ ms}$ (60 Hz), sine | 2380 | A |
| I^2t | $T_{VJ} = 45^\circ\text{C}$; $t = 10\text{ ms}$ (50 Hz), sine | 28800 | A^2s |
| | $t = 8.3\text{ ms}$ (60 Hz), sine | 29300 | A^2s |
| | $T_{VJ} = 150^\circ\text{C}$; $t = 10\text{ ms}$ (50 Hz), sine | 23300 | A^2s |
| | $t = 8.3\text{ ms}$ (60 Hz), sine | 23800 | A^2s |
| T_{VJ} | | -40...+150 | $^\circ\text{C}$ |
| T_{stg} | | -40...+125 | $^\circ\text{C}$ |
| T_{Smax} | | 110 | $^\circ\text{C}$ |
| P_{tot} | $T_C = 25^\circ\text{C}$ | 875 | W |
| V_{ISOL} | 50/60 Hz, RMS $t = 1\text{ min}$ | 3000 | V~ |
| | $I_{ISOL} \leq 1\text{ mA}$ $t = 1\text{ s}$ | 3600 | V~ |
| M_d | Mounting torque (M6) | 2.25-2.75/20-25 | Nm/lb.in. |
| | Terminal connection torque (M6) | 4.50-5.50/40-48 | Nm/lb.in. |
| d_s | Creeping distance on surface | 12.7 | mm |
| d_A | Strike distance through air | 9.6 | mm |
| a | Maximum allowable acceleration | 50 | m/s^2 |
| Weight | | 150 | g |

Features

- International standard package with DCB ceramic base plate
- Planar passivated chips
- Short recovery time
- Low switching losses
- Soft recovery behaviour
- Isolation voltage 3600 V~
- UL registered E 72873

Applications

- Antiparallel diode for high frequency switching devices
- Free wheeling diode in converters and motor control circuits
- Inductive heating and melting
- Uninterruptible power supplies (UPS)
- Ultrasonic cleaners and welders

Advantages

- High reliability circuit operation
- Low voltage peaks for reduced protection circuits
- Low noise switching
- Low losses

| Symbol | Test Conditions | Characteristic Values (per diode) | | |
|----------------------|---|-----------------------------------|------------------------------|--------|
| | | typ. | max. | |
| I_R | $T_{VJ} = 25^\circ\text{C}$ $V_R = V_{RRM}$ | | 3 mA | |
| | $T_{VJ} = 25^\circ\text{C}$ $V_R = 0.8 \cdot V_{RRM}$ | | 2 mA | |
| | $T_{VJ} = 125^\circ\text{C}$ $V_R = 0.8 \cdot V_{RRM}$ | | 80 mA | |
| V_F | $I_F = 150\text{ A}$; $T_{VJ} = 125^\circ\text{C}$ | | 0.80 V | |
| | $T_{VJ} = 25^\circ\text{C}$ | | 0.98 V | |
| | $I_F = 260\text{ A}$; $T_{VJ} = 125^\circ\text{C}$ | | 0.92 V | |
| | $T_{VJ} = 25^\circ\text{C}$ | | 1.07 V | |
| V_{TO} | For power-loss calculations only | | 0.53 V | |
| r_T | | | 1.29 $\text{m}\Omega$ | |
| R_{thJH} | DC current | | 0.228 K/W | |
| R_{thJC} | DC current | | 0.143 K/W | |
| t_{rr} I_{RM} | $I_F = 300\text{ A}$ $V_R = 100\text{ V}$ $-di/dt = 200\text{ A}/\mu\text{s}$ | 150 | $T_{VJ} = 100^\circ\text{C}$ | 200 ns |
| | | | $T_{VJ} = 25^\circ\text{C}$ | 9 A |
| | | | $T_{VJ} = 100^\circ\text{C}$ | 15 A |

① I_{FAVM} rating includes reverse blocking losses at T_{VJM} , $V_R = 0.6 V_{RRM}$, duty cycle $d = 0.5$
 Data according to IEC 60747
 IXYS reserves the right to change limits, test conditions and dimensions

Dimensions in mm (1 mm = 0.0394")

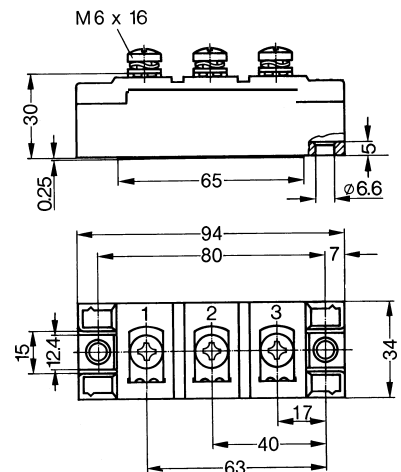

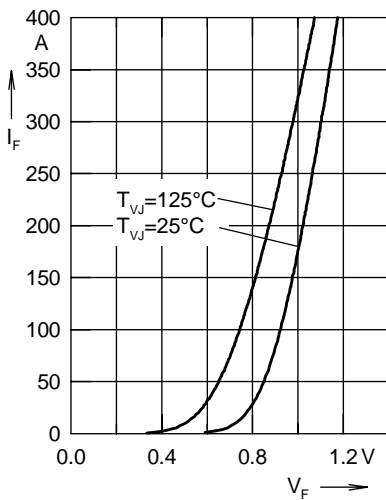
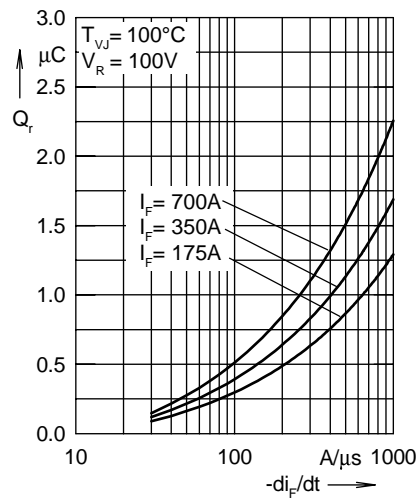
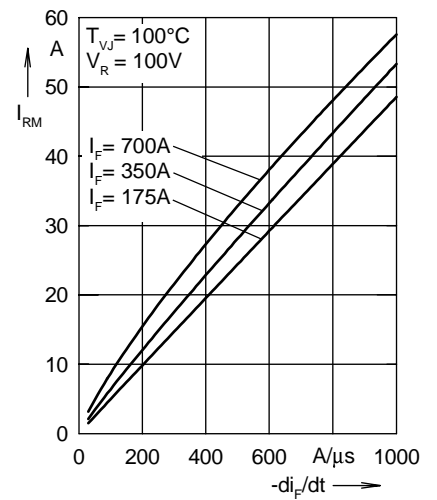
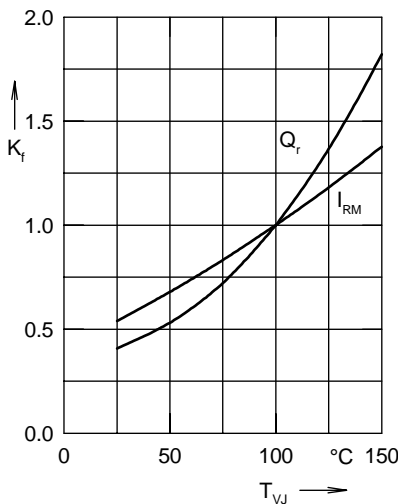
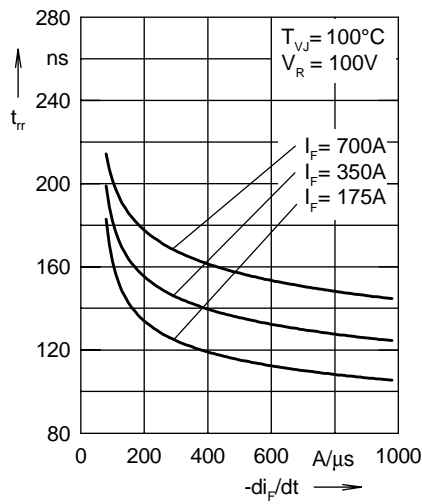
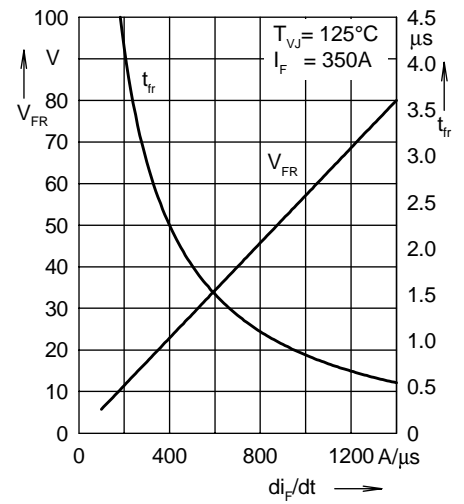
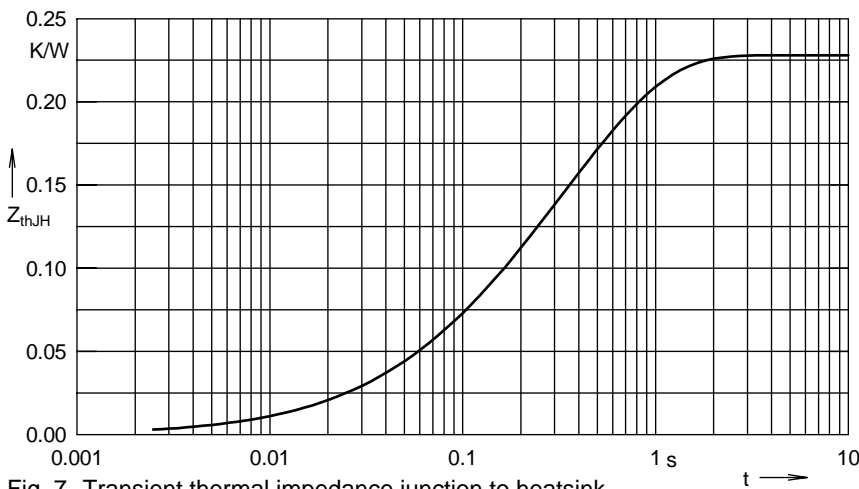

 Fig. 1 Forward current I_F versus voltage drop V_F per leg

 Fig. 2 Reverse recovery charge Q_r versus $-di_F/dt$

 Fig. 3 Peak reverse current I_{RM} versus $-di_F/dt$

 Fig. 4 Dynamic parameters Q_r , I_{RM} versus junction temperature T_{VJ}

 Fig. 5 Recovery time t_{rr} versus $-di_F/dt$

 Fig. 6 Peak forward voltage V_{FR} and t_{fr} versus di_F/dt

Fig. 7 Transient thermal impedance junction to heatsink

 Constants for Z_{thJS} calculation:

| i | R_{thi} (K/W) | t_i (s) |
|---|-----------------|-----------|
| 1 | 0.002 | 0.08 |
| 2 | 0.008 | 0.024 |
| 3 | 0.054 | 0.112 |
| 4 | 0.164 | 0.464 |

AMEYA360

Components Supply Platform

Authorized Distribution Brand :



Website :

Welcome to visit www.ameya360.com

Contact Us :

➤ Address :

401 Building No.5, JiuGe Business Center, Lane 2301, Yishan Rd
Minhang District, Shanghai , China

➤ Sales :

Direct +86 (21) 6401-6692

Email amall@ameya360.com

QQ 800077892

Skype [ameyasales1](#) [ameyasales2](#)

➤ Customer Service :

Email service@ameya360.com

➤ Partnership :

Tel +86 (21) 64016692-8333

Email mkt@ameya360.com