

PCB LAYOUT - COMPONENT VIEW

TECHNICAL CHARACTERISTICS

MATERIAL
 INSULATOR MATERIAL: PBT
 FLAMMABILITY RATING: UL94-V0
 COLOR: BLACK
 CONTACT MATERIAL: COPPER ALLOY
 CONTACT TYPE: STAMPED
 CONTACT PLATING: SELECTIVE GOLD
 QUALITY CLASS: 500 MATING CYCLES

ENVIRONMENTAL
 OPERATING TEMPERATURE: -25 °C UP TO 85 °C
 COMPLIANCE: LEAD FREE AND ROHS

ELECTRICAL
 CURRENT RATING: 1.5 A
 WORKING VOLTAGE: 120 VAC
 INSULATION RESISTANCE: >500 MΩ
 DIELECTRIC WITHSTANDING VOLTAGE: 1 000 VAC/MIN
 CONTACT RESISTANCE: 20 mΩ MAX

STANDARD
 CERTIFIED: E324776

SOLDERING
 JEDEC LEAD FREE WAVE SOLDERING PROCESS

PACKAGING
 TRAY

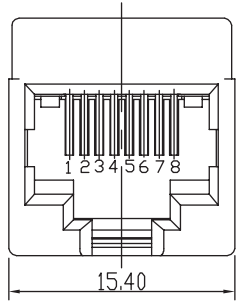
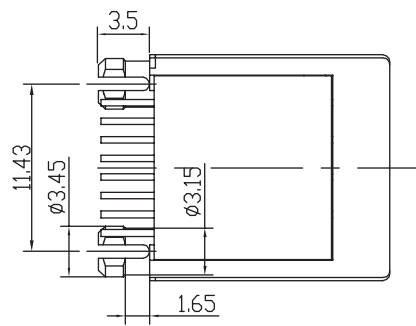
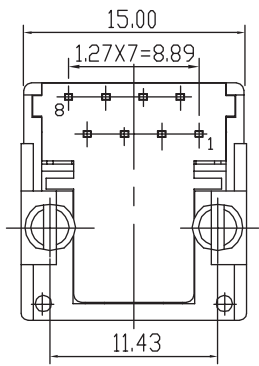
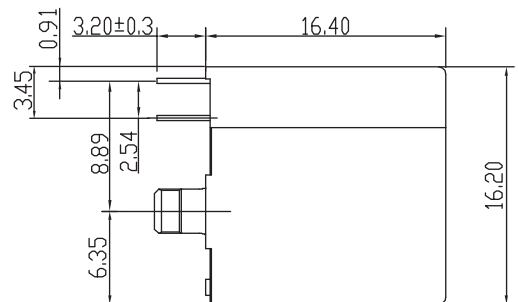

RoHS Compliant			
H	03-JAN-14	TPK DWG ADD	QL
REV	DATE	FILE	BY

PROJECTION:	
APPROVAL: RJ	

GENERAL TOLERANCE
.X = +/- 0.2
.XX = +/- 0.15
UNIT: MM
SCALE:
SHEET: 1/1
DRAW:

DESCRIPTION: VERTICAL PLASTIC 8P8C MODULAR JACK	SIZE
WERI PART NO: 615 008 138 021	A4

A

B

C

D

1

2

3

4

5



A

B

C

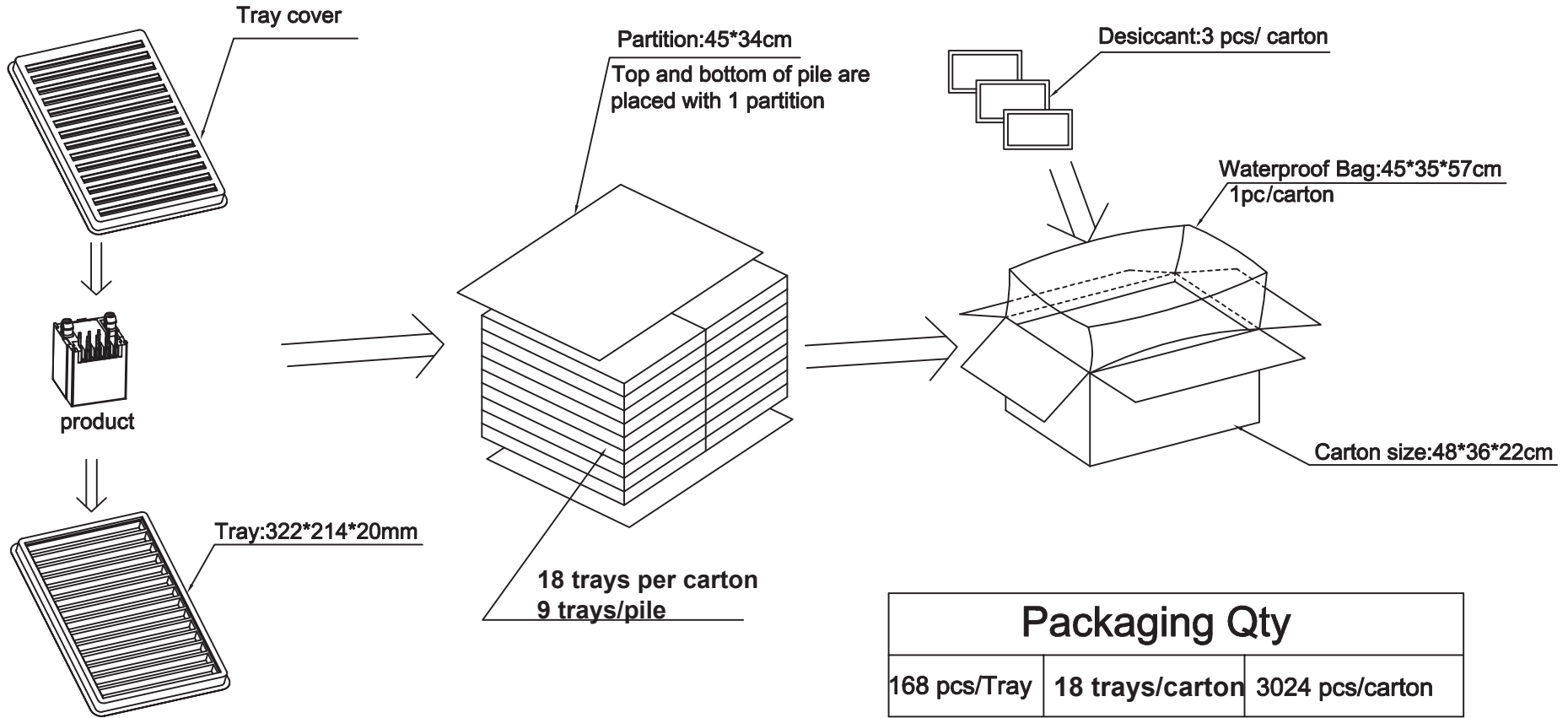
D

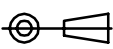

RoHS Compliant				PROJECTION: 	GENERAL TOLERANCE .X = +/- 0.2 .XX = +/- 0.15		DESCRIPTION: VERTICAL PLASTIC 8P8C MODULAR JACK	SIZE A4
G								
F								
E								
D								
C			APPROVAL: RJ	UNIT: MM	WERI PART NO: 615 008 138 021			
B				SCALE:				
A				SHEET: 1/1				
REV	DATE	FILE	BY	DRAW:				

AMEYA360

Components Supply Platform

Authorized Distribution Brand :



Website :

Welcome to visit www.ameya360.com

Contact Us :

➤ Address :

401 Building No.5, JiuGe Business Center, Lane 2301, Yishan Rd
Minhang District, Shanghai , China

➤ Sales :

Direct +86 (21) 6401-6692

Email amall@ameya360.com

QQ 800077892

Skype ameyasales1 ameyasales2

➤ Customer Service :

Email service@ameya360.com

➤ Partnership :

Tel +86 (21) 64016692-8333

Email mkt@ameya360.com