

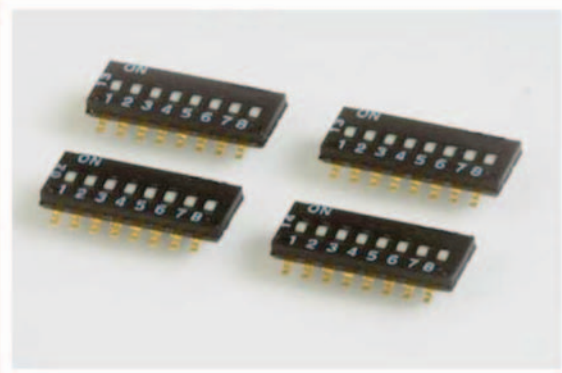

SERIES KAN SWITCHES

HALF-PITCH LOW PROFILE DIP SWITCHES



SPECIFICATIONS

Switch Function:	2, 4, 6, 8 & 10 positions
Ratings:	Switch: 25mA @ 24 VDC Carry: 100mA @ 50 VDC
Contact Resistance:	initial 50mΩ typical @ 2-4 VCD, 100mA
Insulation Resistance:	100 MΩ min. @ 500 VDC
Operating Life:	2,000 make-and-break cycles, each circuit
Dielectric Strength:	500 V rms @ sea level between adjacent terminals
Operating Temperature:	-40° C to 85° C

FEATURES & BENEFITS

- ▶ Half pitch, low profile, SMT
- ▶ Tape & reel packaging

APPLICATIONS/MARKETS

- ▶ Garage door openers
- ▶ Test & instrumentation
- ▶ Telecommunications
- ▶ Controller application

MATERIALS

Base:	PPS UL94 V0, black finish
Cover:	PPS UL94 V0, black finish
Actuator:	Nylon UL94 V0, white finish
Movable Contact:	Copper alloy, gold finish
Terminal Contact:	Brass, gold finish
Tape Seal:	Mylar, amber color

TYPICAL SMT TEMPERATURE PROFILE

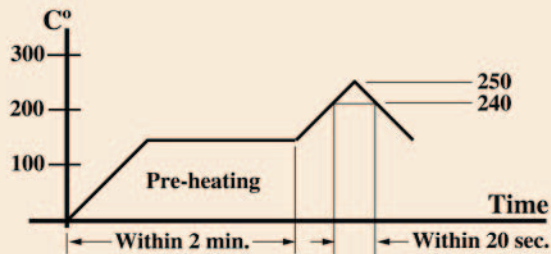

HOW TO ORDER

SERIES	MODEL NO.	TERMINATION	CIRCUIT	NO. OF POSITIONS	ACTUATOR	PACKAGING
KA	N = Low Profile Half-Pitch Type	1 = Gull Wing	1 = SPST	02 04 06 08 10	R = Recessed Actuator	(None) = Std. Tube Qty. T = Std. Tube w/ Top Tape Seal R = Tape and Reel w/ Top Tape Seal



Example Ordering Number

KA-N-1-1-02-R-T

Specifications subject to change without notice.

TACT SWITCHES

NAVIGATION SWITCHES

PUSHBUTTON SWITCHES

TOGGLE SWITCHES

ROCKER SWITCHES

SLIDE SWITCHES

SNAP-ACTION SWITCHES

DIP SWITCHES

KEYLOCK SWITCHES

ROTARY SWITCHES

DETECTOR SWITCHES

CAP OPTIONS



SERIES KAN SWITCHES

HALF-PITCH LOW PROFILE DIP SWITCHES

TACT SWITCHES

NAVIGATION SWITCHES

PUSHBUTTON SWITCHES

TOGGLE SWITCHES

ROCKER SWITCHES

SLIDE SWITCHES

SNAP-ACTION SWITCHES

DIP SWITCHES

KEYLOCK SWITCHES

ROTARY SWITCHES

DETECTOR SWITCHES

CAP OPTIONS

GULL WING

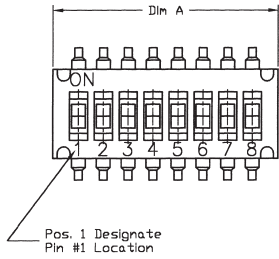

Positions	Dimension A	
	MM	Inches
2	3.77	0.148
4	6.31	0.248
6	8.85	0.348
8	11.39	0.448
10	13.73	0.541

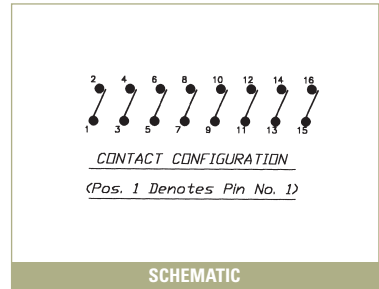
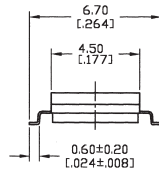
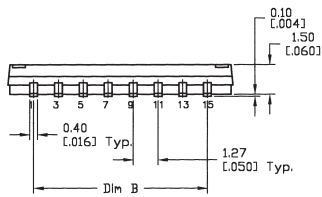
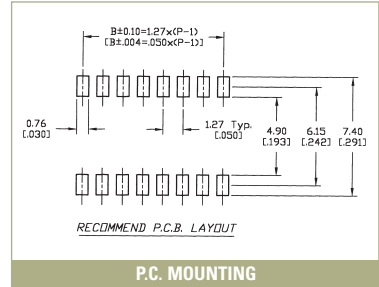

ACTUATOR OPTIONS

WITHOUT TOP TAPE SEAL



WITH TOP TAPE SEAL

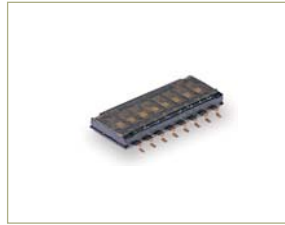

TAPE & REEL PACKAGING

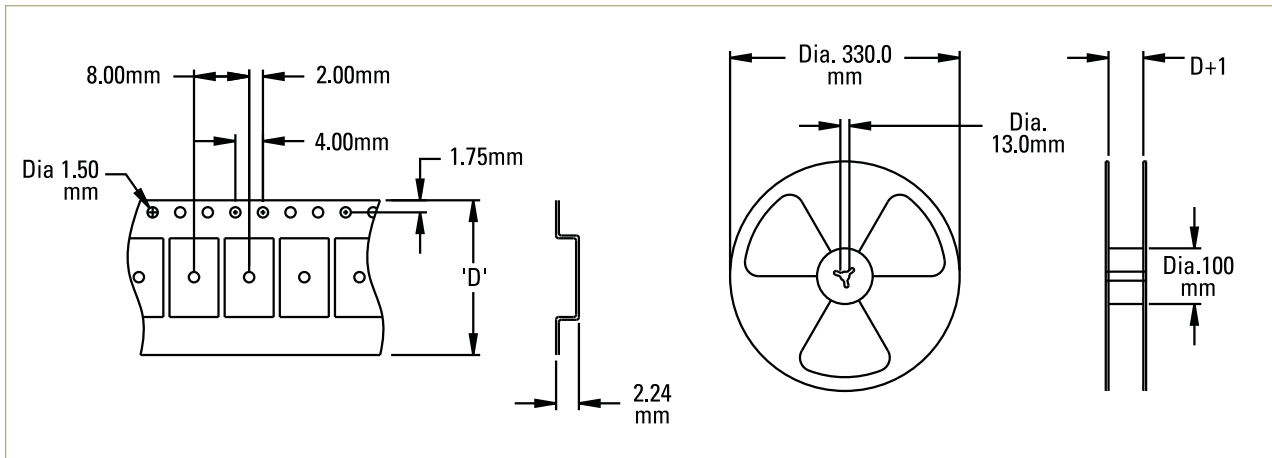

AMEYA360

Components Supply Platform

Authorized Distribution Brand :



Website :

Welcome to visit www.ameya360.com

Contact Us :

➤ Address :

401 Building No.5, JiuGe Business Center, Lane 2301, Yishan Rd
Minhang District, Shanghai , China

➤ Sales :

Direct +86 (21) 6401-6692

Email amall@ameya360.com

QQ 800077892

Skype [ameyasales1](#) [ameyasales2](#)

➤ Customer Service :

Email service@ameya360.com

➤ Partnership :

Tel +86 (21) 64016692-8333

Email mkt@ameya360.com