

FIBRE WASHER

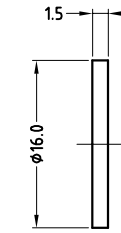

NUT OPTIONS

PLASTIC NUT

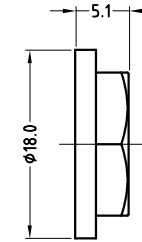

METAL NUT

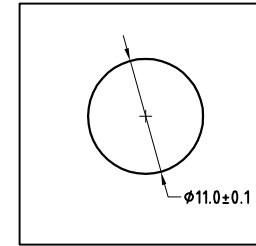
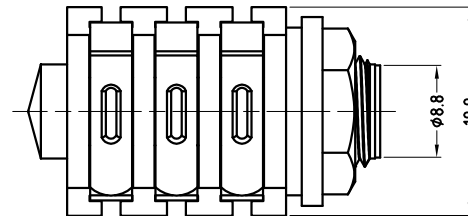
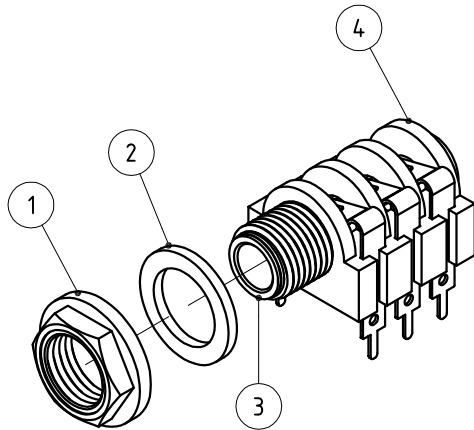
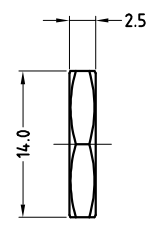

PANEL CUTOUT

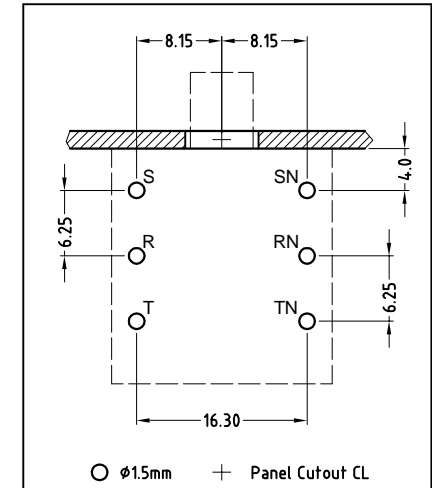

PCB LAYOUT

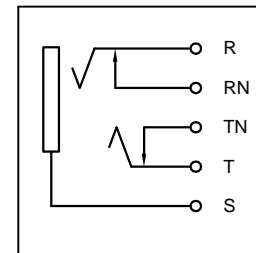

SCHEMATIC

ITEM	DESCRIPTION
1	METAL/PLASTIC NUT
2	FIBRE WASHER
3	METAL TUBE INSERT
4	CONNECTOR ASSEMBLY

PART No.	CATALOG No.	DESCRIPTION
55010098-000	ACJS-MC	METAL NUT
55010098-001	ACJS-PC	PLASTIC NUT

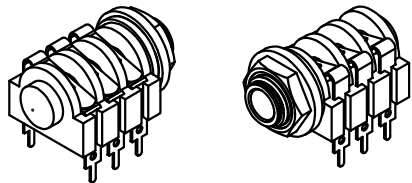

ISO VIEW

UNLESS OTHERWISE SPECIFIED TOLERANCE TO BE		THIS DOCUMENT IS THE PROPERTY OF AMPHENOL AUSTRALIA PTY. LTD. NO PART THEREOF MAY BE REPRODUCED AND USED WITHOUT THE PRIOR WRITTEN CONSENT OF THE OWNER			
LINEAR	ANGULAR	CAD FILE:	55010098000111	DRN:	L.V
X ± 0.5	X° ± 1°	MATL:	REFER TO COMPONENT	CKD:	M.N.H
X.X ± 0.1	X°X' ± 30'	FINISH:	REFER TO COMPONENT	APP'D:	P.M
X.XX ± 0.05	X°X'X" ± 15'	DO NOT SCALE		DATE:	17-10-01
BREAK ALL SHARP EDGES AND REMOVE ALL BURRS		DATE:	13-01-06	DATE:	13-01-06
DIMENSIONS IN MILLIMETRES		SCALE:	2:1 UOS	PART No:	REFER TO TABLE
THIRD ANGLE PROJECTION		TITLE:			

1	CHANGE DRAWING NUMBER & PART VARIATION NUMBER	L.V	07-07-04	8293
0	FIRST ISSUE	L.V	17-10-01	----
REV.	CHANGE DETAILS	BY	DATE	CHG/No
TITLE:		SHEET		
1/4" STEREO JACK PCB & SODLER LUG CUSTOMER DRAWING		1 OF 1		
DRAWING NO.		55010098-000-1		

Amphenol
 Amphenol Australia Pty Ltd, 2 Finemays Blvd, Keysborough, Vic 3173
 DRAWING NO. 55010098-000-1 SHEET 1 OF 1

AMEYA360

Components Supply Platform

Authorized Distribution Brand :



Website :

Welcome to visit www.ameya360.com

Contact Us :

➤ Address :

401 Building No.5, JiuGe Business Center, Lane 2301, Yishan Rd
Minhang District, Shanghai , China

➤ Sales :

Direct +86 (21) 6401-6692

Email amall@ameya360.com

QQ 800077892

Skype ameyasales1 ameyasales2

➤ Customer Service :

Email service@ameya360.com

➤ Partnership :

Tel +86 (21) 64016692-8333

Email mkt@ameya360.com