



# SERIES TL 2201 SWITCHES

## PUSHBUTTON SWITCHES - SUB MINIATURE



### FEATURES & BENEFITS

- ▶ Momentary & latching designs
- ▶ Long travel

### APPLICATIONS/MARKETS

- ▶ Telecommunications
- ▶ Networking
- ▶ Computers/servers
- ▶ Performance audio
- ▶ Instrumentation
- ▶ Low power on/off designs
- ▶ External hard drives and modems

### SPECIFICATIONS

Contact Rating:	100mA@30 VDC
Life Expectancy:	10,000 cycles
Contact Resistance:	100mΩ max.
Insulation Resistance:	100MΩ min.
Dielectric Strength:	500 VAC
Actuation Force:	See individual model
Travel:	See individual model

### MATERIALS

Housing:	PBT
Actuator:	Acetal
Cover:	Acetal
Contacts:	Silver plated phosphor bronze
Terminals:	Silver plated copper alloy
Spring:	Stainless steel
Latching Pin:	Stainless steel



### HOW TO ORDER

SERIES	MODEL NO.	MECHANICAL CONFIGURATION	ACTUATOR ("L" Dimension)	TERMINATION	CAP (Where Avail.)	CAP COLOR
TL	2230 2285	EE = Latching OA = Momentary	(None) = Std.	(None) = Std.	See Cap Section	
TL	2201 = DPDT 4201 = 4PDT	EE = Latching OA = Momentary	X Y Z	A B	See Cap Section	
	2202* 2203	EE = Latching OA = Momentary				



### Example Ordering Number

TL-2201-EE-Y-B-.09-BLK

**\*Note: TL 2202 is an MBB (shorting) version.**

Specifications subject to change without notice.

## TL 2230

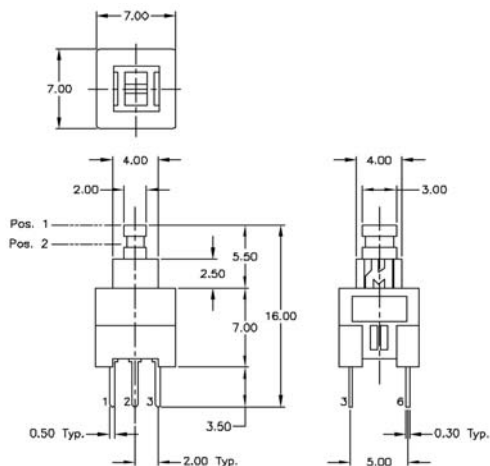



# SERIES TL 2201 SWITCHES

## PUSHBUTTON SWITCHES - SUB MINIATURE

TACT SWITCHES

NAVIGATION SWITCHES

PUSHBUTTON SWITCHES

TOGGLE SWITCHES

ROCKER SWITCHES

SLIDE SWITCHES

SNAP-ACTION SWITCHES

DIP SWITCHES

KEYLOCK SWITCHES

ROTARY SWITCHES

DETECTOR SWITCHES

CAP OPTIONS

### TL 2285



SCHEMATIC

P.C. MOUNTING

### TL 2201



SCHEMATIC

P.C. MOUNTING

### TL 4201



SCHEMATIC

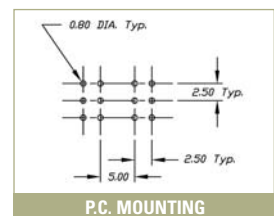

P.C. MOUNTING

## TL 2202

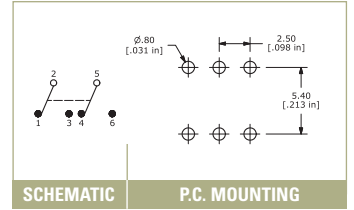
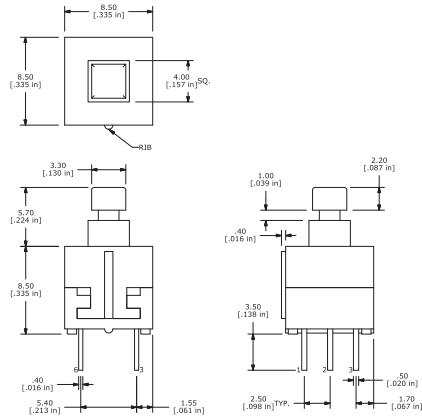

## TL 2203

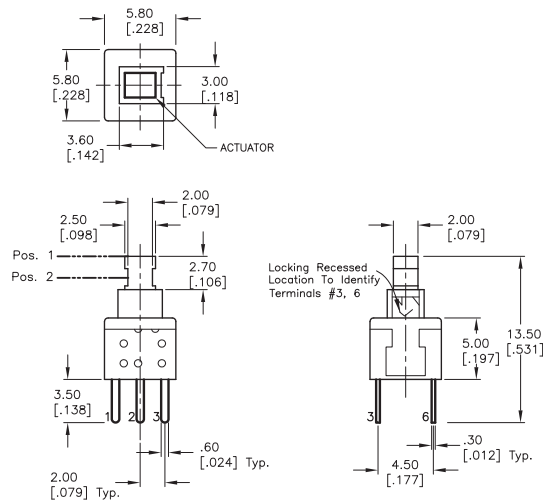

## ACTUATOR OPTIONS – TL 2201 & TL 4201

**X**

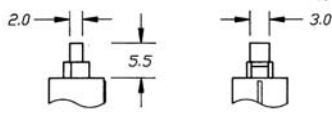

See Cap Section

**Y**

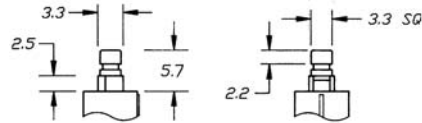

See Cap Section

**Z**

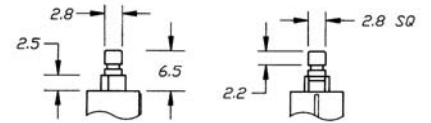

See Cap Section

## TERMINATION OPTIONS – TL 2201 & TL 4201

**A**

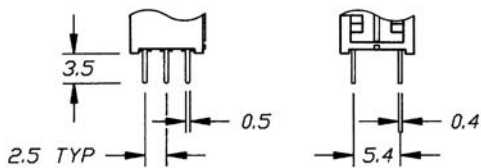

**B**

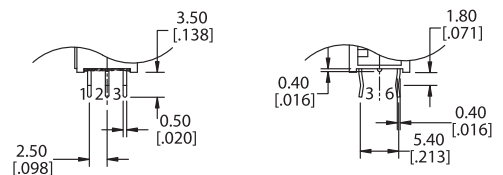

# AMEYA360

## Components Supply Platform

Authorized Distribution Brand :



Website :

Welcome to visit [www.ameya360.com](http://www.ameya360.com)

Contact Us :

➤ Address :

401 Building No.5, JiuGe Business Center, Lane 2301, Yishan Rd  
Minhang District, Shanghai , China

➤ Sales :

Direct +86 (21) 6401-6692

Email [amall@ameya360.com](mailto:amall@ameya360.com)

QQ 800077892

Skype [ameyasales1](#) [ameyasales2](#)

➤ Customer Service :

Email [service@ameya360.com](mailto:service@ameya360.com)

➤ Partnership :

Tel +86 (21) 64016692-8333

Email [mkt@ameya360.com](mailto:mkt@ameya360.com)