

# SMT Air Coil Inductor

AIAC-2712C

**RoHS**  
Compliant

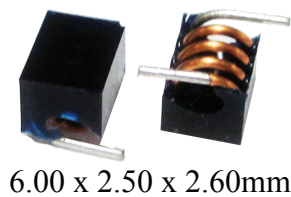

6.00 x 2.50 x 2.60mm

## FEATURES:

- High current design
- Wide Range Frequency Response
- Excellent Q & SRF
- Standard flat cap top suitable for automatic placement.

## APPLICATIONS:

- Widely used in Cordless Phones, High Frequency Communication Equipments, Intercom, CATV,RFID
- Suitable for metal sensors and proximity sensors
- Noise suppression for RF power supply/bias
- I/O filtering, frequency selection for audio devices such as Loudspeakers,Hifi
- Impedance Matching for transceivers
- Improves switch isolation for RF circuit

## STANDARD SPECIFICATIONS:

| PARAMETERS             |                  |
|------------------------|------------------|
| ABRACON P/N:           | AIAC-2712C       |
| Operating temperature: | -40 °C ~ +125 °C |
| Storage temperature:   | -25°C to + 60°C  |

| Part Number     | Inductance | Tolerance | DCR (Max) | Q(Min) | SRF(Min) | Rated Current (Max) | Inductance Code |
|-----------------|------------|-----------|-----------|--------|----------|---------------------|-----------------|
| Units           | nH         | %         | mΩ        |        | GHz      | A                   |                 |
| Symbol          | L          | J         | DCR       |        |          | IDC                 |                 |
| AIAC-2712C-17N5 | 17.50      | J         | 4.5       | 100.0  | 2.2      | 3.5                 | 17N5J           |
| AIAC-2712C-22N0 | 22.00      | J         | 5.0       | 100.0  | 2.0      | 3.0                 | 22N0J           |
| AIAC-2712C-28N0 | 28.00      | J         | 5.6       | 100.0  | 1.8      | 2.8                 | 28N0J           |
| AIAC-2712C-35N5 | 35.50      | J         | 6.2       | 100.0  | 1.2      | 2.7                 | 35N5J           |
| AIAC-2712C-43N5 | 43.50      | J         | 6.7       | 100.0  | 1.0      | 2.5                 | 43N5J           |

## Test Conditions and equipments

Test frequency: 150MHz

Equipment: HP4191A

## PART IDENTIFICATION:

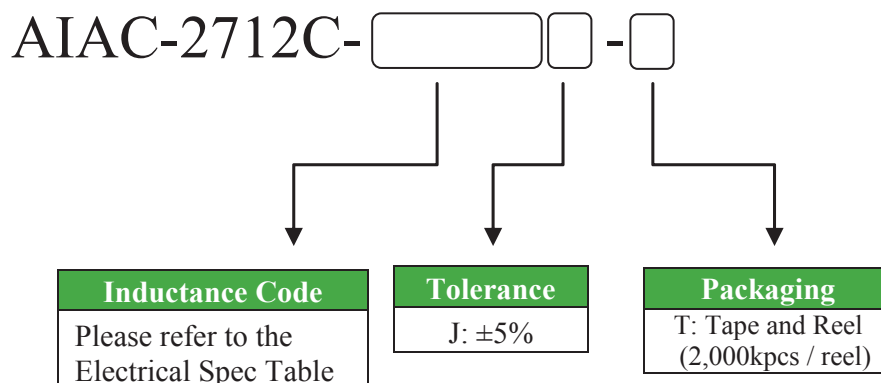

# SMT Air Coil Inductor

AIAC-2712C

**RoHS**  
Compliant

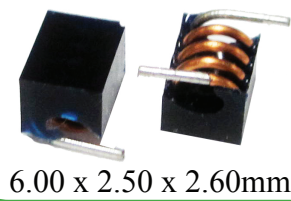

6.00 x 2.50 x 2.60mm

## OUTLINE DRAWING:

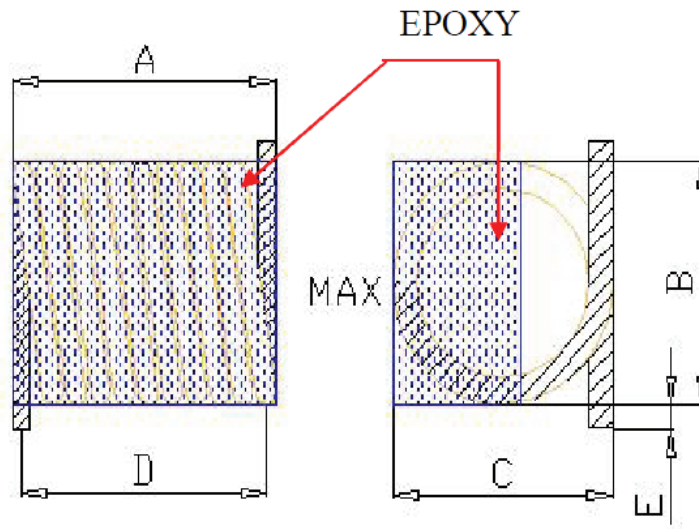

| A        | B        | C        | D        | E        |
|----------|----------|----------|----------|----------|
| 6.00±0.3 | 2.50±0.2 | 2.60±0.2 | 5.80±0.3 | 0.70±0.2 |

Schematic

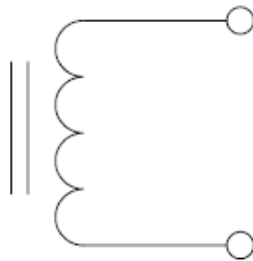

Recommended Land Pattern

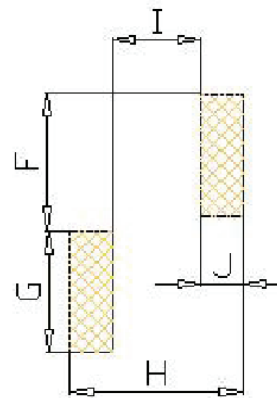

| F   | G   | H   | I   | J   |
|-----|-----|-----|-----|-----|
| 2.8 | 3.3 | 7.4 | 4.9 | 1.3 |

Dimension: mm

# SMT Air Coil Inductor

AIAC-2712C

RoHS  
Compliant

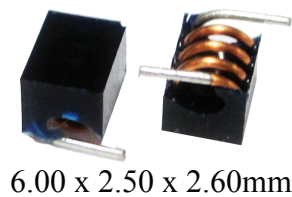

6.00 x 2.50 x 2.60mm

## REFLOW PROFILE:

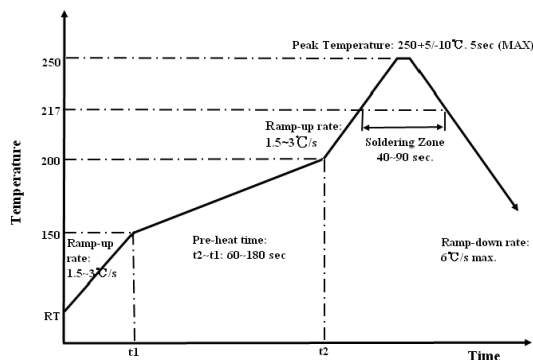

## TAPE & REEL:

Packing  
T: 2,000pcs / reel

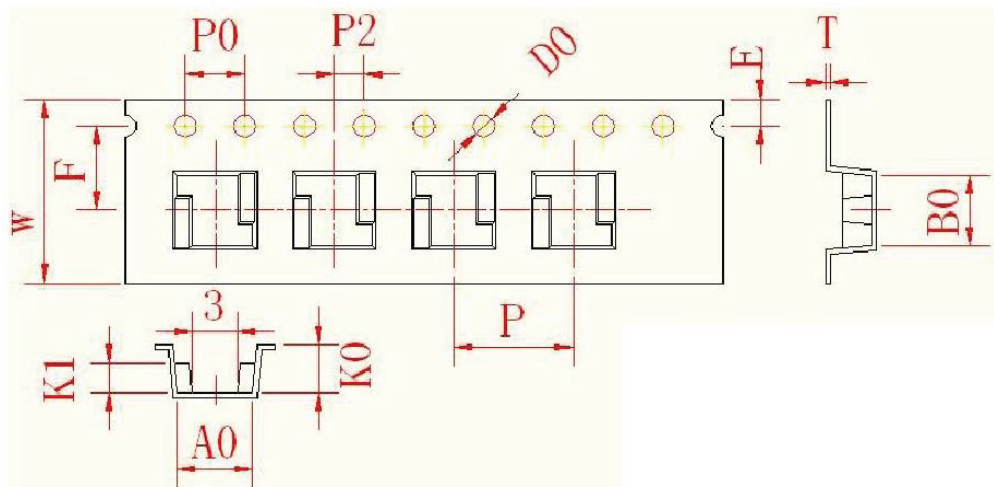

| W        | A0      | B0      | K0      | K1      | P       | F       | E        | D0         | P0      | P2      | T         |
|----------|---------|---------|---------|---------|---------|---------|----------|------------|---------|---------|-----------|
| 16.0±0.3 | 4.7±0.1 | 6.8±0.1 | 3.2±0.1 | 2.0±0.1 | 8.0±0.1 | 7.5±0.1 | 1.75±0.1 | 1.5+0.1/-0 | 4.0±0.1 | 2.0±0.1 | 0.35±0.05 |

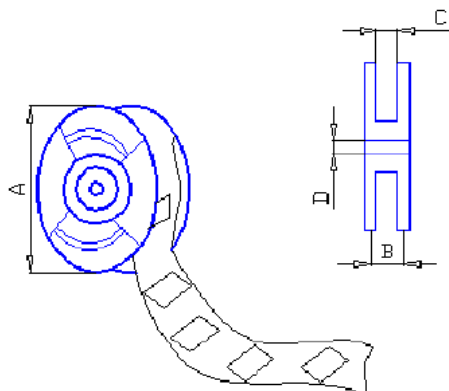

|   |     |
|---|-----|
| A | 330 |
| B | 22  |
| C | 16  |
| D | 13  |

Dimension: mm

**ATTENTION:** Abracon Corporation's products are COTS – Commercial-Off-The-Shelf products; suitable for Commercial, Industrial and, where designated, Automotive Applications. Abracon's products are not specifically designed for Military, Aviation, Aerospace, Life-dependant Medical applications or any application requiring high reliability where component failure could result in loss of life and/or property. For applications requiring high reliability and/or presenting an extreme operating environment, written consent and authorization from Abracon Corporation is required. Please contact Abracon Corporation for more information.

ABRACON IS  
ISO 9001:2008  
CERTIFIED



Visit [www.abracon.com](http://www.abracon.com) for Terms & Conditions of Sale  
30332 Esperanza, Rancho Santa Margarita, California 92688  
tel 949-546-8000 | fax 949-546-8001 | [www.abracon.com](http://www.abracon.com)

Revised: 11.20.12

# AMEYA360

## Components Supply Platform

Authorized Distribution Brand :



Website :

Welcome to visit [www.ameya360.com](http://www.ameya360.com)

Contact Us :

➤ Address :

401 Building No.5, JiuGe Business Center, Lane 2301, Yishan Rd  
Minhang District, Shanghai , China

➤ Sales :

Direct +86 (21) 6401-6692

Email [amall@ameya360.com](mailto:amall@ameya360.com)

QQ 800077892

Skype [ameyasales1](#) [ameyasales2](#)

➤ Customer Service :

Email [service@ameya360.com](mailto:service@ameya360.com)

➤ Partnership :

Tel +86 (21) 64016692-8333

Email [mkt@ameya360.com](mailto:mkt@ameya360.com)