

General Descriptions

- DDC144NS features discrete dual NPN transistors that can support continuous maximum current up to 100 mA. It is suited for applications where the load needs to be turned on and off using circuits like micro-controllers, comparators, etc., particularly at a point of load. The component devices can be used as a part of a circuit or as a stand alone discrete device.

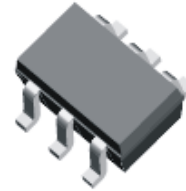

Fig. 1: SOT-363

Features

- Epitaxial Planar Die Construction
- Ideally Suited for Automated Assembly Processes
- Lead Free By Design/RoHS Compliant (Note 1)**
- "Green" Device (Note 2)**

Mechanical Data

- Case: SOT-363
- Case Material: Molded Plastic. "Green" Molding Compound. UL Flammability Classification Rating 94V-0
- Moisture Sensitivity: Level 1 per J-STD-020C
- Terminal Connections: See Figure 2
- Terminals: Finish - Matte Tin annealed over Alloy 42 leadframe. Solderable per MIL-STD-202, Method 208
- Marking Information: See Page 3
- Ordering Information: See Page 3
- Weight: 0.0065 grams (approximate)

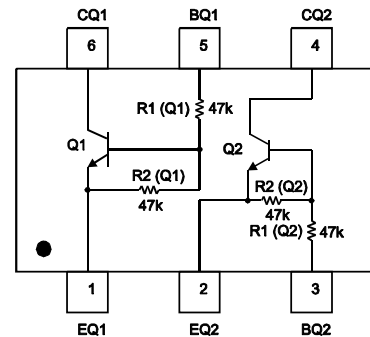

Fig. 2: Schematic and Pin Configuration

Maximum Ratings, Total Device

@T_A = 25°C unless otherwise specified

Characteristic	Symbol	Value	Unit
Power Dissipation (Note 3)	P _d	200	mW
Thermal Resistance, Junction to Ambient Air (Note 3)	R _{θJA}	625	°C/W
Operating and Storage Temperature Range	T _i , T _{STG}	-55 to +150	°C
Collector Current	I _{C(max)}	100	mA

Maximum Ratings:

Sub-Component Device - Pre-Biased NPN Transistor

@T_A = 25°C unless otherwise specified

Characteristic	Symbol	Value	Unit
Supply Voltage	V _{CC}	50	V
Input Voltage	V _{in}	-10 to +40	V
Output Current	I _O	100	mA

Electrical Characteristics:

Pre-Biased NPN Transistor

@T_A = 25°C unless otherwise specified

Characteristic	Symbol	Min	Typ	Max	Unit	Test Condition
Input Voltage	V _{I(off)}	0.5	1.1	—	V	V _{CC} = 5V, I _O = 100uA
	V _{I(on)}	—	1.5	3	V	V _O = 0.3V, I _O = 2mA
Output Voltage	V _{O(on)}	—	0.1	0.3	V	I _O /I _I = 10mA/0.5mA
Input Current	I _I	—	—	0.18	mA	V _I = 5V
Output Current	I _{O(off)}	—	—	0.5	uA	V _{CC} = 50V, V _I = 0V
DC Current Gain	G _I	100	—	—	—	V _O = 5V, I _O = 5mA
Input Resistor (R1) Tolerance	Δ R1	-30	—	+30	%	—
Resistance Ratio Tolerance	R2/R1	-20	—	+20	%	—
Gain-Bandwidth Product	f _T	—	250	—	MHz	V _{CE} = 10V, I _E = 5mA, f = 100 MHz

- Notes:
- No purposefully added lead.
 - Diodes Inc.'s "Green" policy can be found on our website at http://www.diodes.com/products/lead_free/index.php.
 - Device mounted on FR-4 PCB, 1 inch x 0.85 inch x 0.062 inch; pad layout as shown on page 4 or go to Diodes Inc. suggested pad layout document AP02001, which can be found on our website at <http://www.diodes.com/datasheets/ap02001.pdf>

Typical Characteristics of NPN Transistor

@ $T_A = 25^\circ\text{C}$ unless otherwise specified

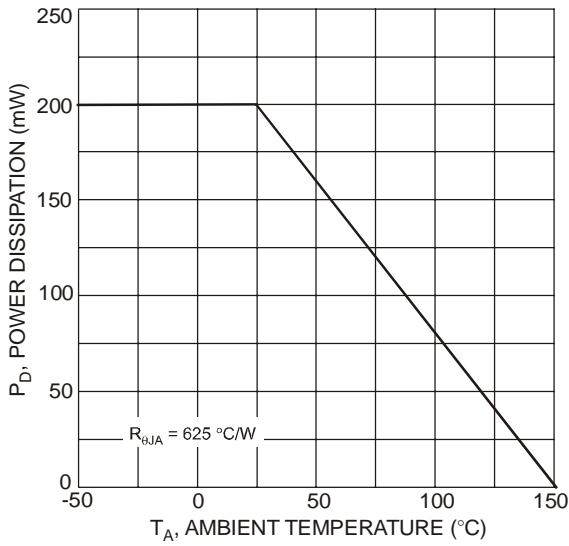

Fig. 3 Derating Curve

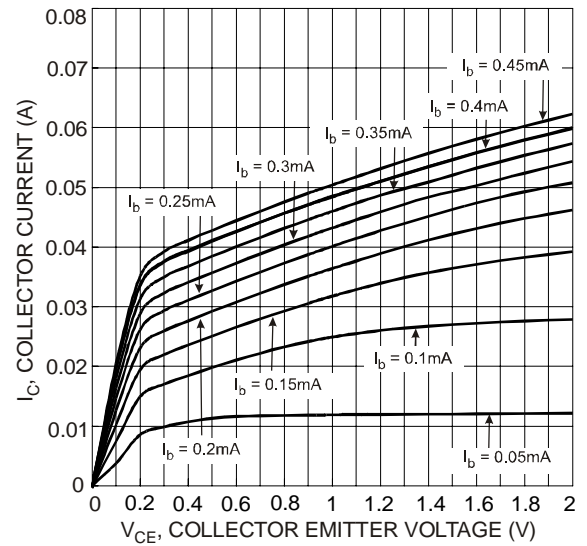

Fig. 4 Typical V_{CE} vs. I_C

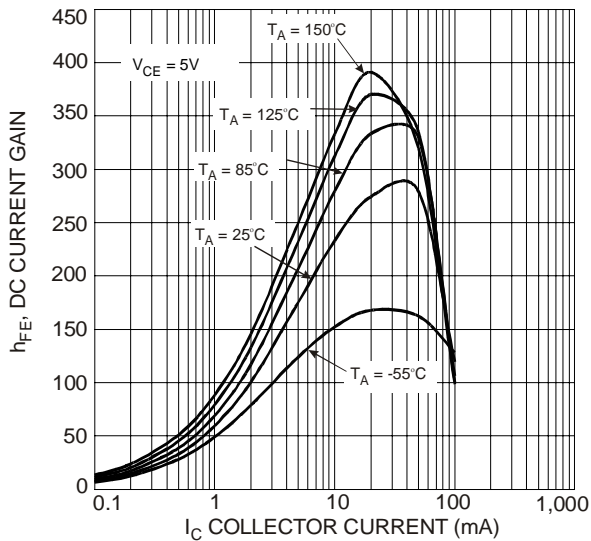

Fig. 5 Typical DC Current Gain

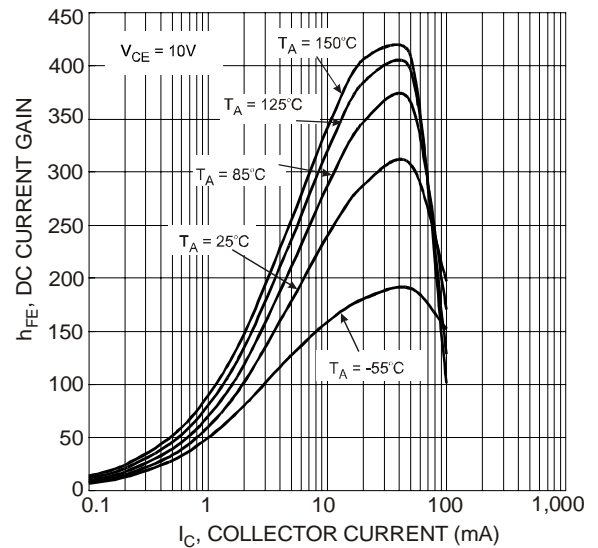

Fig. 6 Typical DC Current Gain

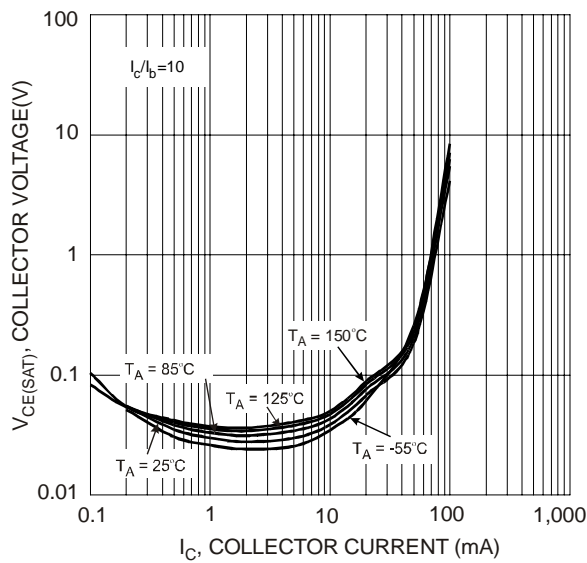

Fig. 7 Typical $V_{CE(SAT)}$ vs. I_C

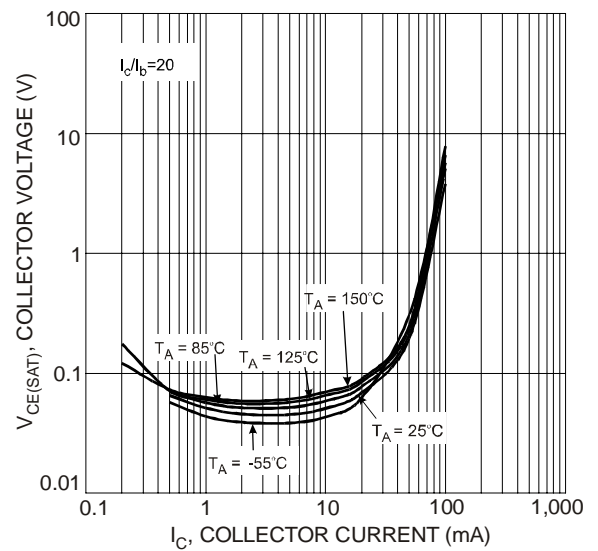

Fig. 8 Typical $V_{CE(SAT)}$ vs. I_C

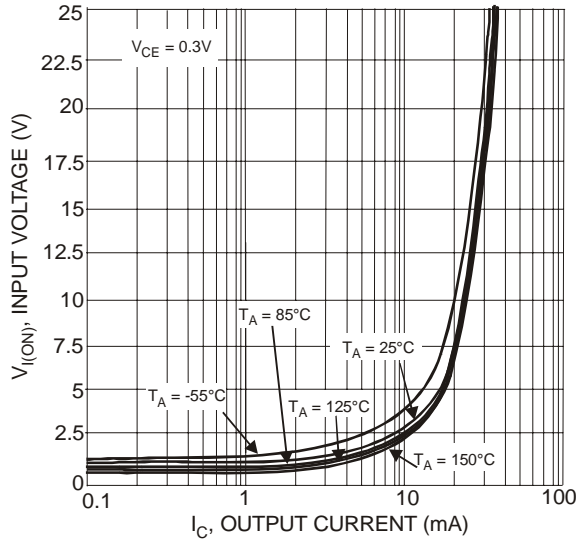

Fig. 9 Typical Input Voltage vs. Output Current

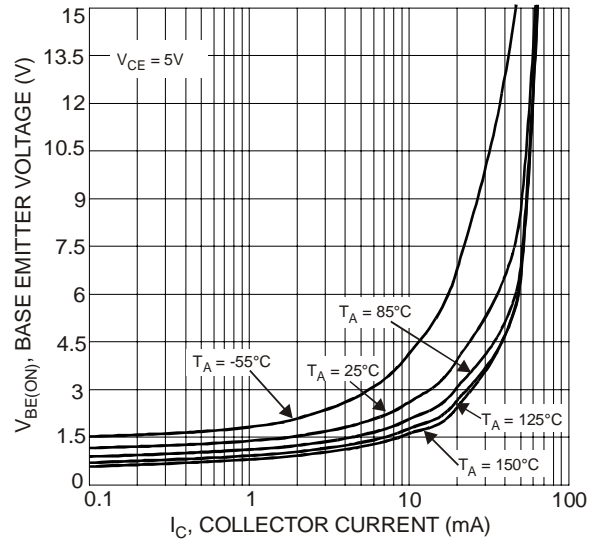

Fig. 10 Typical $V_{BE(ON)}$ vs. I_C

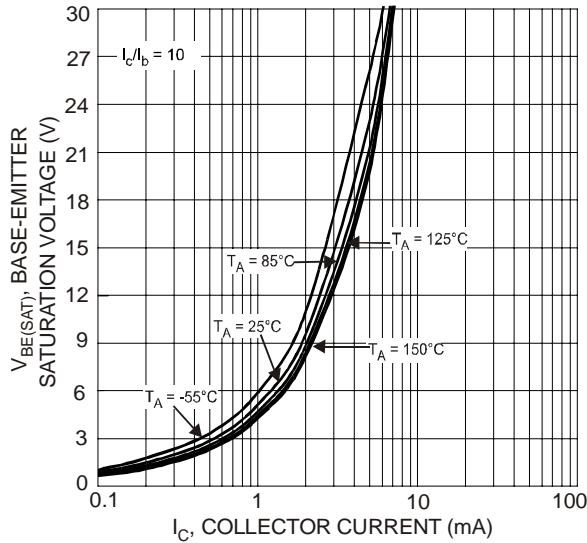

Fig. 11 Typical $V_{BE(SAT)}$ vs. I_C

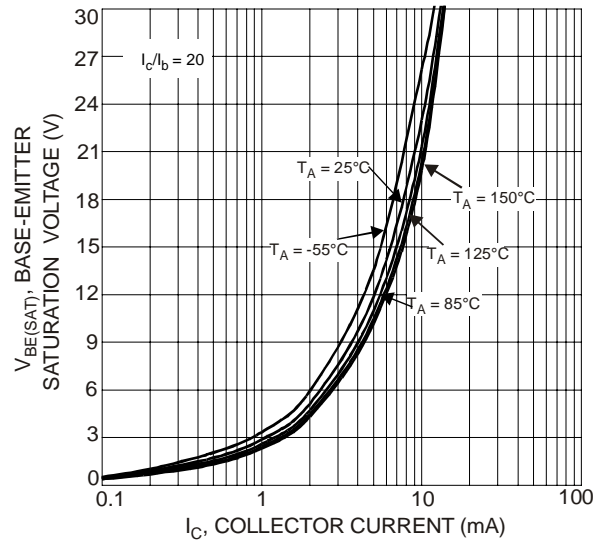

Fig. 12 Typical $V_{BE(SAT)}$ vs. I_C

Ordering Information (Note 4)

Device	Packaging	Shipping
DDC144NS-7	SOT-363	3000/Tape & Reel

Notes: 4. For packaging details, go to our website at <http://www.diodes.com/datasheets/ap02007.pdf>.

Marking Information

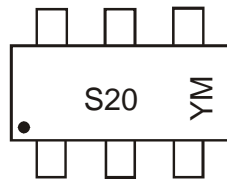

Fig. 13

S20 = Product Type Marking Code,
 YM = Date Code Marking
 Y = Year, e.g., T = 2006
 M = Month, e.g., 9 = September

Date Code Key

Year	2005	2006	2007	2008	2009	2010	2011	2012
Code	S	T	U	V	W	X	Y	Z

Month	Jan	Feb	Mar	Apr	May	Jun	Jul	Aug	Sep	Oct	Nov	Dec
Code	1	2	3	4	5	6	7	8	9	O	N	D

Package Outline Dimensions

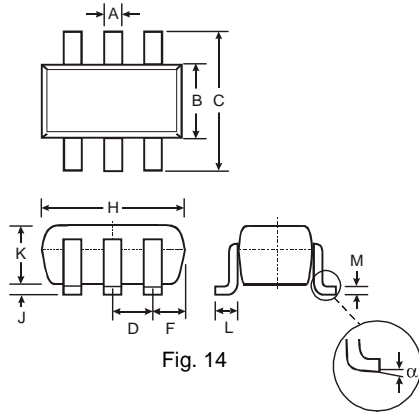

SOT-363		
Dim	Min	Max
A	0.10	0.30
B	1.15	1.35
C	2.00	2.20
D	0.65 Nominal	
F	0.30	0.40
H	1.80	2.20
J	—	0.10
K	0.90	1.00
L	0.25	0.40
M	0.10	0.25
α	0°	8°
All Dimensions in mm		

Suggested Pad Layout

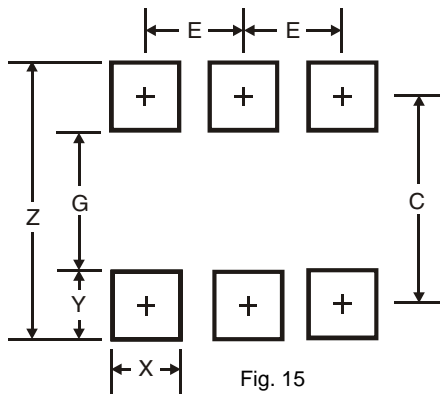

Dimensions	SOT-363*
Z	2.5
G	1.3
X	0.42
Y	0.6
C	1.9
E	0.65

* Typical dimensions in mm

IMPORTANT NOTICE

Diodes Incorporated and its subsidiaries reserve the right to make modifications, enhancements, improvements, corrections or other changes without further notice to any product herein. Diodes Incorporated does not assume any liability arising out of the application or use of any product described herein; neither does it convey any license under its patent rights, nor the rights of others. The user of products in such applications shall assume all risks of such use and will agree to hold Diodes Incorporated and all the companies whose products are represented on our website, harmless against all damages.

LIFE SUPPORT

Diodes Incorporated products are not authorized for use as critical components in life support devices or systems without the expressed written approval of the President of Diodes Incorporated.

AMEYA360

Components Supply Platform

Authorized Distribution Brand :



Website :

Welcome to visit www.ameya360.com

Contact Us :

➤ Address :

401 Building No.5, JiuGe Business Center, Lane 2301, Yishan Rd
Minhang District, Shanghai , China

➤ Sales :

Direct +86 (21) 6401-6692

Email amall@ameya360.com

QQ 800077892

Skype [ameyasales1](#) [ameyasales2](#)

➤ Customer Service :

Email service@ameya360.com

➤ Partnership :

Tel +86 (21) 64016692-8333

Email mkt@ameya360.com