



MAX9888 Evaluation Kit

Evaluates: MAX9888

General Description

The MAX9888 evaluation kit (EV kit) is a fully assembled and tested circuit board that evaluates the MAX9888 audio codec. The MAX9888 is an integrated audio codec including microphone amplifiers, line amplifiers, an earpiece amplifier, stereo Class D amplifiers, stereo DirectDrive® headphone amplifiers, and digital signal processing. The EV kit also includes Windows XP®, Windows Vista®, and Windows® 7-compatible software that provides a simple graphical user interface (GUI) for exercising the features of the device.

The EV kit provides access to all analog and digital inputs/outputs on the device. To enable easy connection to a wide range of audio sources, audio devices are included to convert both USB data and S/PDIF data to I2S.

The EV kit integrates a MAXQ2000 microcontroller to enable I2C communication with devices on the EV kit. The EV kit software, running on a Windows PC, communicates with the EV kit over a standard USB port. The EV kit software provides an intuitive interface to exercise the functions of the device.

The EV kit comes with a MAX9888EWY+ installed.

Features

- ◆ 2.8V to 5.5V Single-Supply Operation
- ◆ Proven Audio PCB Layout
- ◆ On-Board USB-to-I2C Interface
- ◆ On-Board USB-to-I2S Converter
- ◆ On-Board S/PDIF Transceiver
- ◆ On-Board Clock Source
- ◆ On-Board Digital Microphone
- ◆ Evaluates the MAX9888EWY+ in a 3.8mm x 3.3mm, 63-Bump WLP Package
- ◆ Windows XP-, Windows Vista-, and Windows 7-Compatible Software
- ◆ Fully Assembled and Tested

Ordering Information

PART	TYPE
MAX9888EVKIT+	EV Kit

+Denotes lead(Pb)-free and RoHS compliant.

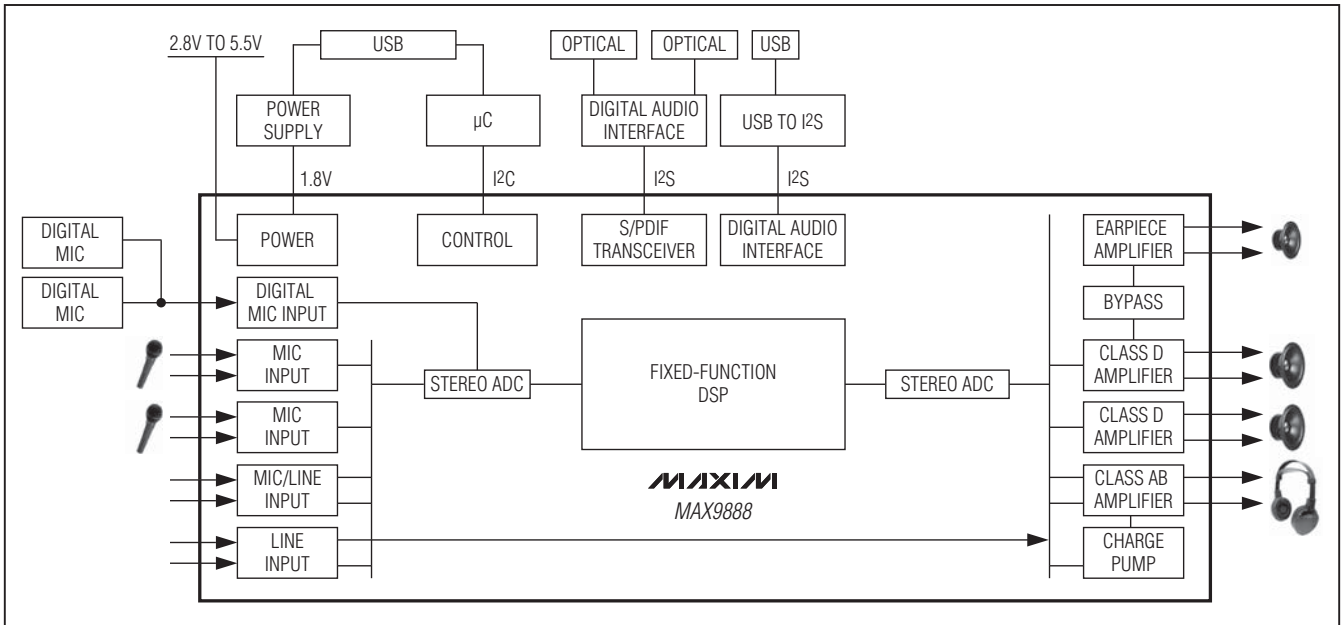

Figure 1. Block Diagram

DirectDrive is a registered trademark of Maxim Integrated Products, Inc.

Windows, Windows XP, and Windows Vista are registered trademarks of Microsoft Corp.



MAX9888 Evaluation Kit

Evaluates: MAX9888

Component List

DESIGNATION	QTY	DESCRIPTION
C1, C2, C52, C70	4	10 μ F \pm 20%, 6.3V X5R ceramic capacitors (0805) TDK C2012X5R0J106M
C3, C11, C12, C16	4	0.1 μ F \pm 10%, 16V X7R ceramic capacitors (0603) TDK C1608X7R1C104K
C4–C9, C122–C125	10	10pF \pm 5%, 50V C0G ceramic capacitors (0402) Murata GRM1555C1H100J
C14, C15, C23, C25, C43, C50, C53, C54	8	1 μ F \pm 20%, 6.3V X5R ceramic capacitors (0603) Taiyo Yuden JMK107B7105MA
C19, C20, C31, C32, C57	5	0.01 μ F \pm 10%, 50V X7R ceramic capacitors (0603) Murata GRM188R71H103K
C21, C22, C27, C29, C35, C40, C42, C44–C47, C51	12	0.1 μ F \pm 10%, 50V X5R ceramic capacitors (0603) TDK C1608X5R1H104K
C24, C26	2	2.2 μ F \pm 10%, 6.3V X5R ceramic capacitors (0603) Murata GRM188R60J225K
C28	1	47000pF \pm 10%, 25V X7R ceramic capacitor (0603) Murata GRM188R71E473K
C30	1	0.47 μ F \pm 10%, 6.3V X5R ceramic capacitor (0603) Murata GRM188R60J474K
C36, C41, C73, C74	4	8pF \pm 0.5pF, 50V C0H ceramic capacitors (0402) Taiyo Yuden UMK105CH080DV
C38, C58–C65, C119, C120, C132, C133	0	Not installed, ceramic capacitors (0402)
C39	1	0.033 μ F \pm 10%, 25V X7R ceramic capacitor (0603) Murata GRM188R71E333K

DESIGNATION	QTY	DESCRIPTION
C48, C49	2	18pF \pm 5%, 50V C0G ceramic capacitors (0603) TDK C1608C0G1H180J
C55, C56, C69	3	0.1 μ F \pm 10%, 10V X7R ceramic capacitors (0402) KEMET C0402C104K8RAC
C66, C72	2	47 μ F \pm 20%, 6.3V X5R ceramic capacitors (1206) Murata GRM31CR60J476M
C67, C68, C71, C77, C78, C92, C93, C100–C104, C114–C118, C121, C126–C129, C131	23	1 μ F \pm 10%, 6.3V X5R ceramic capacitors (0402) TDK C1005X5R0J105K
C88–C91, C134–C139	10	0.22 μ F \pm 10%, 6.3V X5R ceramic capacitors (0402) TDK C1005X5R0J224K
C130	1	2.2 μ F \pm 20%, 6.3V X5R ceramic capacitor (0402) Taiyo Yuden JMK105BJ225MV
D1	1	Yellow LED (0603)
D2	1	Red LED (0603)
EXTMICN, EXTMICP, HPL, HPR	0	Not installed, multipurpose test points
FB1, FB2	2	Ferrite beads (0603) Murata BLM18PG221SN1
FB3–FB10	8	Ferrite beads (0402) Murata BLM15HD182SN1
FB11, FB12, FB14, FB15	4	0 Ω \pm 5% resistors (0603)
FB13, FB16	2	0 Ω \pm 5% resistors (0402)
J1, J10	2	USB mini-B right-angle PC-mount receptacles
J3	1	3.5mm surface-mount stereo headphone jack
J5	1	Digital audio optical transmitter Toshiba TOTX147L

MAX9888 Evaluation Kit

Component List (continued)

DESIGNATION	QTY	DESCRIPTION
J6	1	Digital audio optical receiver Toshiba TORX147L
J12–J15	4	Red RCA jacks
JU12	1	5-pin header
JU13, JU19	2	12-pin (3 x 4) headers
JU14–JU17, JU22, JU27, JU28, JU30, JU32, JU34– JU37, JU40, JU41, JU42	16	2-pin headers
JU20	1	6-pin (2 x 3) header
L1	1	47 μ H, 220mA ferrite bead (1812) Murata LQH43MN470J03L
L2–L5	0	Not installed, inductors (6.2mm x 6.3mm) TOKO D63CB series (22 μ H)
Q1	1	n-channel 2N7002 MOSFET (SOT23)
R1, R9–R14, R31, R32, R33, R56, R59, R60, R61	14	0 Ω \pm 5% resistors (0402)
R2, R15, R16, R29	0	Not installed, resistors (0402)
R3	1	1M Ω \pm 5% resistor (0603)
R4, R28	2	10k Ω \pm 5% resistors (0603)
R5	1	10k Ω \pm 5% resistor (0402)
R17	1	402 Ω \pm 1% resistor (0603)
R18	1	47k Ω \pm 5% resistor (0603)
R19, R20	2	220 Ω \pm 5% resistors (0603)
R21, R22, R23	3	1.5k Ω \pm 5% resistors (0603)
R24, R25	2	27 Ω \pm 5% resistors (0603)
R26	1	470 Ω \pm 5% resistor (0603)
R27	1	2.2k Ω \pm 5% resistor (0603)
R34, R37	2	1.5k Ω \pm 5% resistors (0402)
R35, R36, R39, R41, R42, R43	6	22 Ω \pm 5% resistors (0402)

DESIGNATION	QTY	DESCRIPTION
R38	1	1M Ω \pm 5% resistor (0402)
R50, R53	2	0 Ω \pm 5% resistors (0603)
R54, R55, R57, R58	4	2.2k Ω \pm 5% resistors (0402)
SPKLN, SPKRN	2	Black multipurpose test points
SPKLP, SPKRP	2	Red multipurpose test points
U1	1	Stereo audio codec (63 WLP) Maxim MAX9888EWY+
U2	1	1.8V low-noise linear regulator (5 SC70) Maxim MAX8510EXK18+ (Top Mark: AEA)
U3	1	1.8V low-noise linear regulator (5 SOT23) Maxim MAX8887EZK18+ (Top Mark: ADPX)
U4	1	Digital audio transceiver (28 SO) Cirrus Logic CS8427-CSZ
U5	1	USB audio codec (32 QFP) Texas Instruments PCM2707PJT
U7	1	UART-to-USB converter (32 QFN)
U8	1	Low-power microcontroller (56 TQFN-EP*) Maxim MAXQ2000-RBX+
U9, U16	2	3.3V low-noise linear regulators (5 SC70) Maxim MAX8511EXK33+ (Top Mark: AEI)
U10	1	93C46 type 3-wire EEPROM 16-bit architecture (8 SO)
U11	1	2.5V low-noise linear regulator (5 SC70) Maxim MAX8511EXK25+ (Top Mark: ADV)
U12	1	1.8V digital microphone (6 LGA) Akustica AKU2002C (Top Mark: A2002C)

Evaluates: MAX9888

MAX9888 Evaluation Kit

Evaluates: MAX9888

Component List (continued)

DESIGNATION	QTY	DESCRIPTION
U13	0	Not installed, 1.8V digital microphone (6 LGA) Akustica AKU2002C
U14, U17, U23, U24	4	Dual SPDT switches (10 μ DFN) Maxim MAX4906ELB+
Y2	1	13MHz crystal oscillator (3.2mm x 2.5mm)
Y3	1	16MHz crystal oscillator (3.2mm x 2.5mm)
Y4	1	12MHz crystal oscillator (3.2mm x 2.5mm)

DESIGNATION	QTY	DESCRIPTION
Y5	1	6MHz crystal (HC49) Hong Kong X'tals SSL60000N1HK188F0-0
—	4	22 μ H, 1A inductor (6.2mm x 6.3mm) TOKO #A916C4-220M
—	2	USB high-speed A-to-mini-B cables, 6ft
—	18	Shunts
—	1	PCB: MAX9888 EVALUATION KIT+

*EP = Exposed pad.

Component Suppliers

SUPPLIER	PHONE	WEBSITE
Akustica, Inc.	412-390-1730	www.akustica.com
Hong Kong X'tals Ltd.	852-35112388	www.hongkongcrystal.com
KEMET Corp.	864-963-6300	www.kemet.com
Murata Electronics North America, Inc.	770-436-1300	www.murata-northamerica.com
Taiyo Yuden	800-348-2496	www.t-yuden.com
TDK Corp.	847-803-6100	www.component.tdk.com
TOKO America, Inc.	847-297-0070	www.tokoam.com

Note: Indicate that you are using the MAX9888 when contacting these component suppliers.

MAX9888 Evaluation Kit

Evaluates: MAX9888

Quick Start

Required Equipment

- MAX9888 EV kit (USB cables included)
- User-supplied Windows XP, Windows Vista, or Windows 7 PC with a spare USB port
- 2.8V to 5.5V, 1A DC power supply
- Set of headphones with a 3.5mm plug

Note: In the following sections, software-related items are identified by bolding. Text in **bold** refers to items directly from the EV kit software. Text in **bold and underlined** refers to items from the Windows operating system.

Procedure

The EV kit is fully assembled and tested. Follow the steps below to configure the EV kit for audio playback and control from the PC to verify the EV kit is functioning properly.

- 1) Visit www.maxim-ic.com/evkitsoftware to download the latest version of the EV kit software, 9888Rxx.ZIP. Save the EV kit software to a temporary folder and uncompress the ZIP file.
- 2) Install the EV kit software and USB driver on your computer by running the INSTALL.EXE program inside the temporary folder. The program files are copied to your PC and icons are created in the Windows **Start | Programs** menu. During software installation, some versions of Windows may show a warning message indicating that this software is from an unknown publisher. This is not an error condition and it is safe to proceed with installation. Administrator privileges are required to install the USB device driver on Windows.
- 3) Verify that all jumpers are in their default positions, as shown in Table 1.
- 4) Connect the power supply between the SPKVDD and GND PCB pads.
- 5) Set the power supply to 3.7V and turn it on.
- 6) Connect the USB cable from the PC to the EV kit board. A Windows message appears when connecting the EV kit board to the PC for the first time. Each version of Windows has a slightly different message. If you see a Windows message stating **ready to use**, then proceed to the next step. Otherwise, open the USB_Driver_Help_200.PDF document in the Windows **Start | Programs** menu to verify that the USB driver was installed successfully.
- 7) Start the EV kit software by opening its icon in the **Start | Programs | Maxim EVKIT Software** menu. The EV kit software main window appears, as shown in Figure 2.
- 8) Wait while the software connects to the EV kit. Once the connection is established, the status bar at the bottom displays **USB Connected** and **MAX9888 Connected**.
- 9) Once the EV kit software has initialized, select the **Digital Audio** tab.
- 10) Click on the USB block.
- 11) Click **Yes** to automatically configure the EV kit for USB audio playback.
- 12) Connect a USB cable between the PC and J10. Windows automatically detects the EV kit has a sound card and installs the USB audio class drivers. A USB DAC option is added to the list of available playback devices. All audio played through this device is sent to the IC.
- 13) Connect headphones to J3 to hear audio generated by the PC.

MAX9888 Evaluation Kit

Detailed Description of Software

Graphical User Interface

The MAX9888 EV kit software uses a block diagram interface to control all the functions of the MAX9888 audio codec. Click on blocks on the **Analog Audio** tab (Figure 2) and **Digital Audio** tab (Figure 3) to control various functions of the device. Each block that represents multiple control options displays a dialog box containing all available controls for that block. Blocks that represent a single option toggle the enable of that function when clicked. Blocks colored grey are disabled while blocks colored blue are enabled. Click on the **MAX9888 Power**

button to enable/disable the device. The icon is shaded grey when the device is in shutdown. The icon is shaded blue when the device is enabled.

Register Map Control Interface

To view the device's register settings, select the **Control Registers** tab (Figure 4). The value of all control registers is displayed and updated automatically when changes are made using the graphical user interface (GUI). Click on bit names or enter register values in hexadecimal format to manually program the device's registers. Changes to the register map automatically update the GUI.

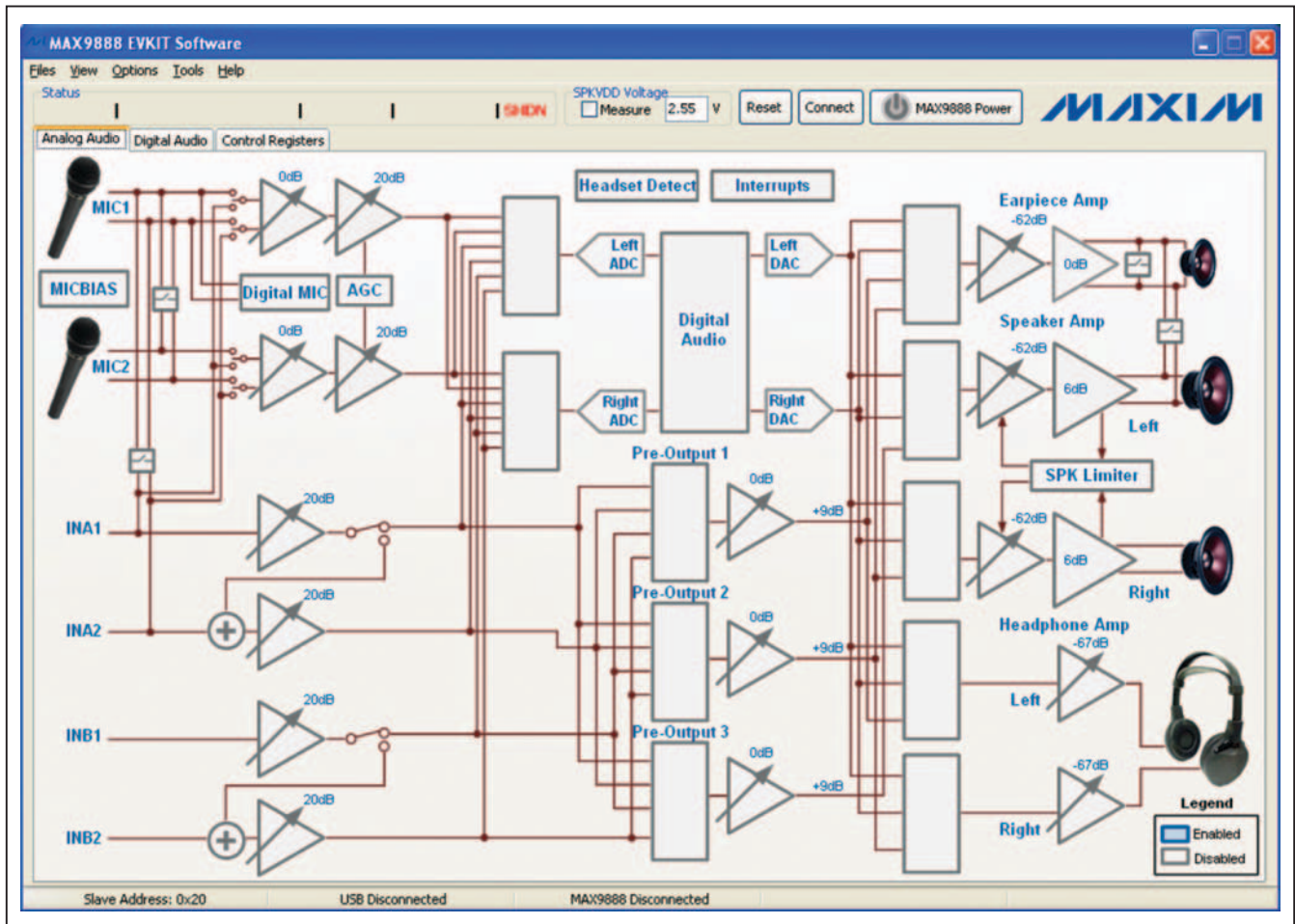

Figure 2. MAX9888 EV Kit Software Main Window (Analog Audio Tab)

MAX9888 Evaluation Kit

Evaluates: MAX9888

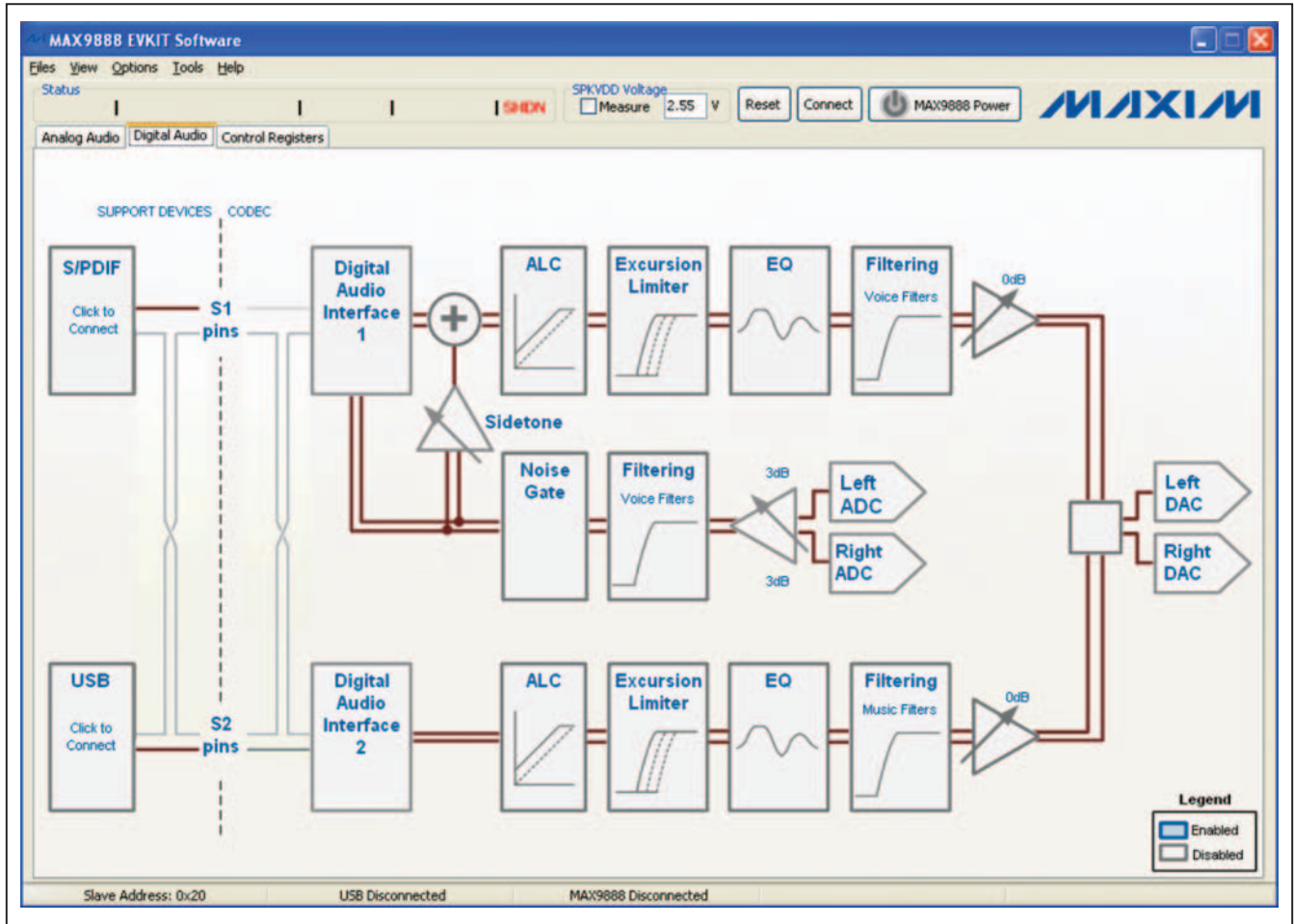

Figure 3. MAX9888 EV Kit Software Main Window (Digital Audio Tab)

MAX9888 Evaluation Kit

Evaluates: MAX9888

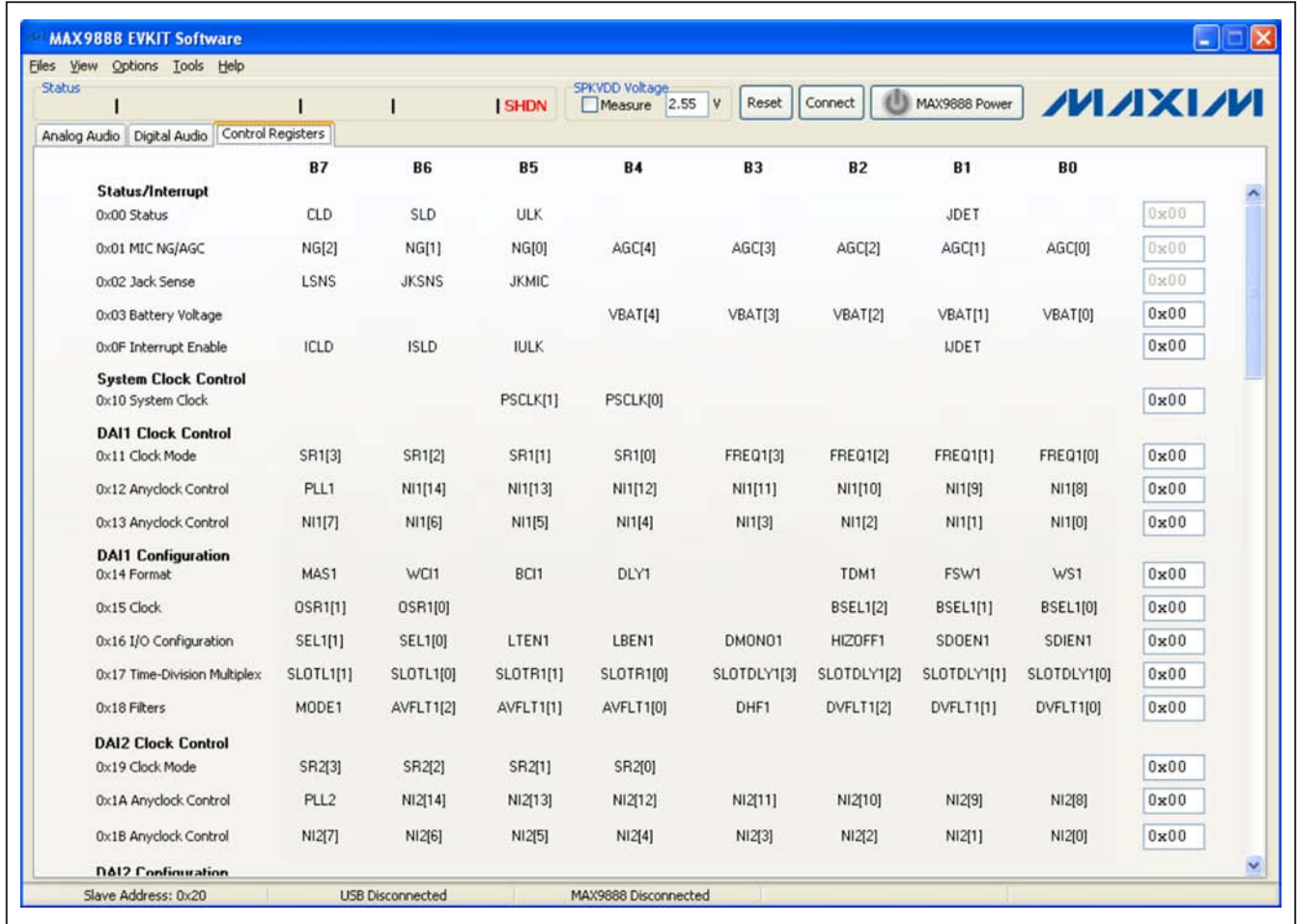

Figure 4. MAX9888 EV Kit Software Main Window (Control Registers Tab)

MAX9888 Evaluation Kit

Global Control Buttons

Buttons at the top of the EV kit software window control the connection and synchronization of the software with the device.

Press **Reset** to restore the EV kit to power-on default settings. Uncheck options that need not be reset.

Press **Connect** to reconnect to the EV kit after the software is started. The **Connect** button is disabled when the software is already connected to the EV kit. The **Connect** button is used primarily if the EV kit is connected to the PC after the software is already running.

File Menu

The EV kit software can save its state to a configuration file for loading at a later time. Select the **Save Settings** menu item from the **File** menu bar to save the current configuration. A **Save As** dialog box appears to allow the location for the saved file to be selected. Files are saved with the extension .ax14.

Select **Load Settings** to revert to a saved configuration. An **Open** dialog box appears to allow the location of the saved configuration file to be specified. The default directory lists several presaved options. Alternatively, .ax14 files are associated with the EV kit software. Double click on a saved file to launch the EV kit software and load the saved configuration.

Select **Exit** to exit the software.

View Menu

The **Show S/PDIF Transceiver Registers** menu item under the **View** menu bar displays a new tab sheet for manually controlling the CS8427.

Options Menu

When the **Auto Connect** menu item is selected from the **Options** menu bar, the software automatically connects to the EV kit board as soon as the connection is available.

When **Auto Read Status** is selected, the software automatically reads the device registers every 1000ms.

The **I²C Clock Speed** submenu item selects the speed of the I²C interface as either 400kHz or 100kHz.

Configure I²S Routing selects which of the I²S ports the S/PDIF and USB devices connect to.

Tools Menu

Select the **Debug Tools** menu item under the **Tools** menu bar to directly send I²C commands to the EV kit.

Select **Export Register Setup File** to export the value of all registers set to a nondefault setting.

Select **Read All Registers** to update the software settings with the register settings of the connected EV kit. This option is useful if the EV kit software is restarted without power cycling the EV kit.

Select **Write All Registers** to download all software settings to the connected EV kit. This option is useful when power has been removed from the device. Pressing the **Write All Registers** button is only necessary when the device's entire register bank needs updating. Individual register changes are made automatically.

Detailed Description of Hardware

The MAX9888 EV kit evaluates the MAX9888 audio codec and provides access to all analog and digital inputs/outputs on the device. In addition, the EV kit includes support circuitry that eases evaluation of the device.

Power Supplies

The EV kit requires a single 2.8V to 5.5V external supply to operate. For evaluation other than power consumption, all other supplies are generated from USB bus power. Jumpers JU14–JU17 (see Table 1) allow all supplies on the device to be disconnected from USB bus power and powered externally. This allows varying the supply voltage and performing supply current measurements.

Class D Filters

The device integrates stereo Class D amplifiers. Although these amplifiers are designed to operate completely filterless, filters are often helpful during evaluation. Stuffing options for two types of filters are provided on the EV kit.

When long speaker cables are used with the device, a ferrite bead plus capacitor filter can be installed to prevent excessive EMI radiation. Although it is best to choose filter components based on EMI test results, the combination of a 680pF capacitor with the Murata BLM18SG331TN1 ferrite bead generally works well.

To allow analysis of the audio output with an oscilloscope, or an analyzer not designed to accept Class D switching waveforms, populate L2–L5 with the included 22μH inductors and make connections to external equipment and speakers at FSPKLP, FSPKLN, FSPKRP, and FSPKRN. The LC filter is designed to work best with an 8Ω load. Do not connect the load at SPKLP, SPKLN, SPKRP, and SPKRN when L2–L5 are installed.

MAX9888 Evaluation Kit

S/PDIF Transceiver

The CS8427 S/PDIF transceiver serves as a format converter between I²S and S/PDIF. Use this device to send and receive digital audio over the optical connectors (J5, J6).

When receiving S/PDIF data, the CS8427 outputs a recovered master clock that is exactly $256 \times f_s$, where f_s is the sample rate. This clock signal can be used to clock the device.

When transmitting S/PDIF data, the CS8427 requires a master-clock input. If S/PDIF data is also being received, the CS8427 uses this data to generate its own master clock. If S/PDIF data is not being received, then the CS8427 generates a master clock based on the LRCLK signal being output by the device. For proper transmit-only operation, the device must be configured in master mode.

USB Audio

The PCM2707 USB DAC generates I²S audio data from a USB connection to the PC. The PCM2707 supports

standard class drivers that are included in most operating systems. As a result, no drivers are required for this device. The PCM2707 appears as a sound card in the PC and allows audio playback from the PC through the device. The PCM2707 also generates a master-clock signal that can be used to clock the device. The clock signal is $256 \times f_s$.

Digital Microphone

The device includes an on-board digital microphone to demonstrate the digital microphone input. Install shunts on jumpers JU27 and JU32 to enable the microphone. When using the digital microphone, the MIC1 analog microphone input cannot be used. If a second digital microphone is added, then MIC2 is also unavailable.

Jumper Selection

The EV kit includes 20 jumpers to adjust various hardware configuration options. Table 1 describes all the jumpers available on the EV kit.

Table 1. Jumper Selection

JUMPER	SHUNT POSITION	DESCRIPTION
JU12	—	See Table 2
JU13	—	See Table 3
JU14	1-2*	Connects 1.8V to DVDD
	Open	Allows external powering of DVDD
JU15	1-2*	Connects 1.8V to AVDD
	Open	Allows external powering of AVDD
JU16	1-2*	Connects 1.8V to HPVDD
	Open	Allows external powering of HPVDD
JU17	1-2*	Connects 3.3V to DVDDS1
	Open	Allows external powering of DVDDS1
JU19	—	See Table 3
JU20	2-3*, 5-6*	Connects the on-board I ² C master to the device
	Open	Allows external control of the device over I ² C
JU22	1-2*	Connects 3.3V to DVDDS2
	Open	Allows external powering of DVDDS2
JU27	1-2	Connects the digital microphone data output to the device
	Open*	Disconnects the digital microphone data output from the device
JU28	1-2*	Connects the device interrupt output ($\overline{\text{IRQ}}$) to the on-board microcontroller
	Open	Disconnects the device interrupt output ($\overline{\text{IRQ}}$) to the on-board microcontroller
JU30	1-2	Connects JACKSNS to MIC1 for jack detection
	Open*	Disconnects JACKSNS from MIC1
JU32	1-2	Connects the digital microphone clock input to the device
	Open*	Disconnects the digital microphone clock input from the device

MAX9888 Evaluation Kit

Evaluates: MAX9888

Table 1. Jumper Selection (continued)

JUMPER	SHUNT POSITION	DESCRIPTION
JU34	1-2	Connects a 2.2kΩ resistor from MIC1N to ground for microphone biasing
	Open*	Disconnects MIC1N from ground
JU35	1-2	Connects a 2.2kΩ resistor from MIC2N to ground for microphone biasing
	Open*	Disconnects MIC2N from ground
JU36	1-2	Grounds MIC1N for single-ended operation on MIC1
	Open*	Enables differential operation on MIC1
JU37	1-2	Grounds MIC2N for single-ended operation on MIC2
	Open*	Enables differential operation on MIC2
JU40	1-2	Connects MIC1P to MICBIAS through a 2.2kΩ resistor
	Open*	Disconnects MIC1P from MICBIAS
JU41	1-2	Connects MIC2P to MICBIAS through a 2.2kΩ resistor
	Open*	Disconnects MIC2P from MICBIAS
JU42	1-2*	Allows software to sense that a voltage is applied to SPKVDD (through SPKVDD_ POWERED net driving MAXQ2000)
	Open	Disconnects Q1 for accurate SPKVDD supply current measurement

*Default position.

Master Clock Selection

Jumper JU12 selects which master-clock source clocks the device. The available clocks are shown in Table 2. The EV kit software indicates the correct clock source to use depending on which audio source is in use. If an external audio source is used, choose either the on-board 13MHz oscillator or an external clock. To connect the external clock, remove the shunt from JU12 and connect the clock to the center pin.

Digital Audio Interface

Jumpers JU13 and JU19 provide access to the digital audio interfaces on the device. See Table 3 for individual pin descriptions. When using the on-board USB and S/PDIF audio sources, install shunts between pins 2-3 on each row. When using an external audio source, remove the shunts and connect the audio source clock and data lines to position 2 of the header. Position 1 on each row provides a convenient ground connection.

Table 2. Clock Sources (JU12)

SHUNT POSITION	CLOCK SOURCE
1-2	Disabled
1-3	CS8427 recovered master clock
1-4	13MHz oscillator
1-5*	PCM2707 recovered master clock

*Default position.

Control Interface

Jumper JU20 connects the on-board I²C master to the device. When using an external I²C master, remove both shunts from JU20 and connect position 1 to SDA and SCL on the external I²C master. Install pullup resistors at R15 and R16 if the external master does not include pullup resistors.

Microphone Bias and Jack Sense

Jumpers JU34–JU37, JU40, and JU41 provide microphone biasing on MIC1 and MIC2. To provide microphone bias, install a shunt on JU40 and JU41. For single-ended microphone inputs, install shunts on JU36 and JU37. For differential microphone inputs, install shunts on JU34 and JU35.

To enable microphone detection on MIC1, install a shunt on JU30.

MAX9888 Evaluation Kit

Evaluates: MAX9888

Table 3. Digital Audio Interface (JU13, JU19)

JUMPER	POSITION 1	POSITION 2	POSITION 3
JU13	GND	BCLKS1 (device)	BCLK (I ² S1)
	GND	LRCLKS1 (device)	LRCLK (I ² S1)
	GND	SDINS1 (device)	DAC Input (I ² S1)
	GND	SDOUTS1 (device)	ADC Output (I ² S1)
JU19	GND	BCLKS2 (device)	BCLK (I ² S2)
	GND	LRCLKS2 (device)	LRCLK (I ² S2)
	GND	SDINS2 (device)	DAC Input (I ² S2)
	GND	SDOUTS2 (device)	ADC Output (I ² S2)

Note: Default shunt position is between pins 2-3 for all rows.

MAX9888 Evaluation Kit

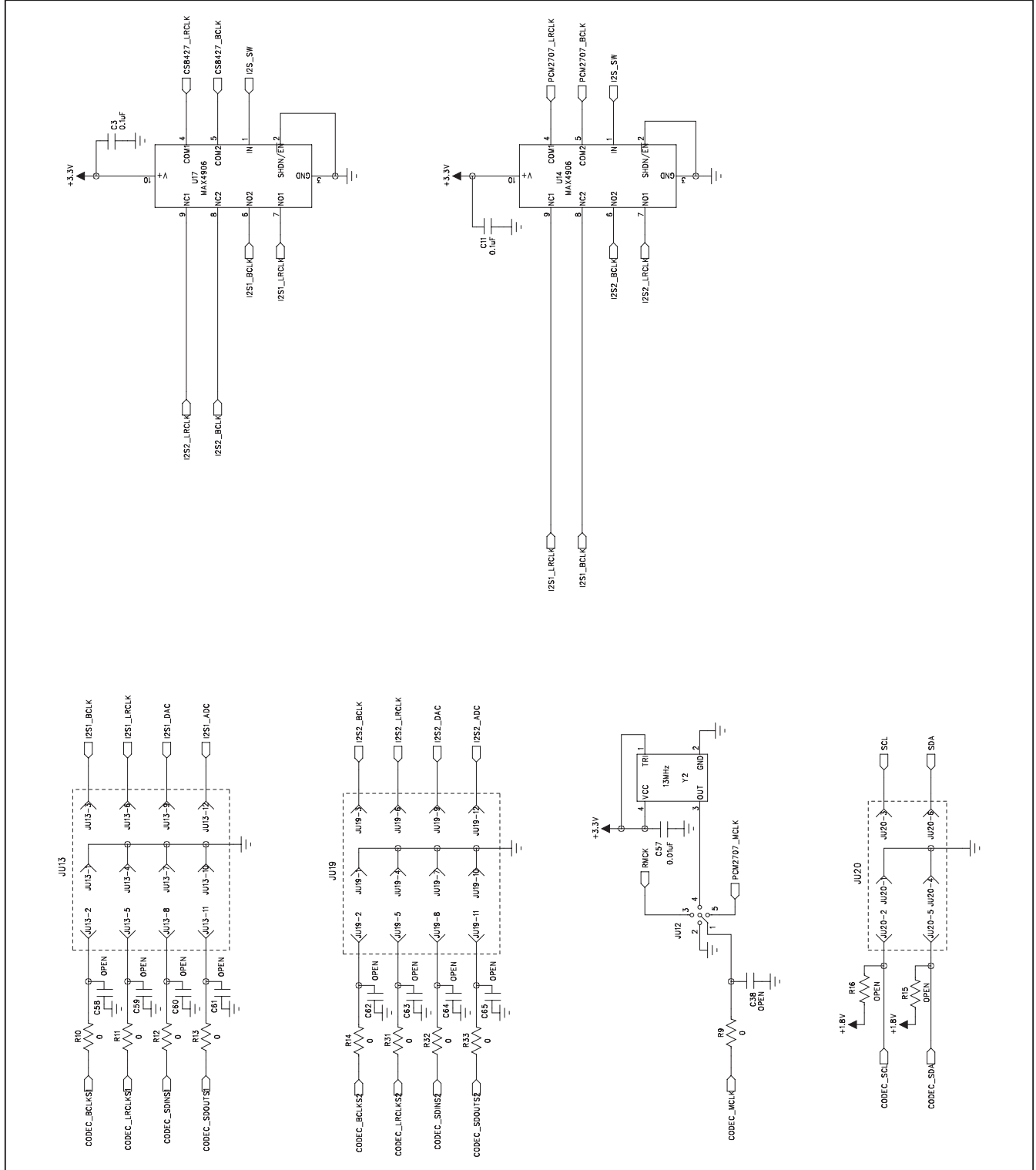

Figure 5b. MAX9888 EV Kit Schematic (Sheet 2 of 5)

MAX9888 Evaluation Kit

Evaluates: MAX9888

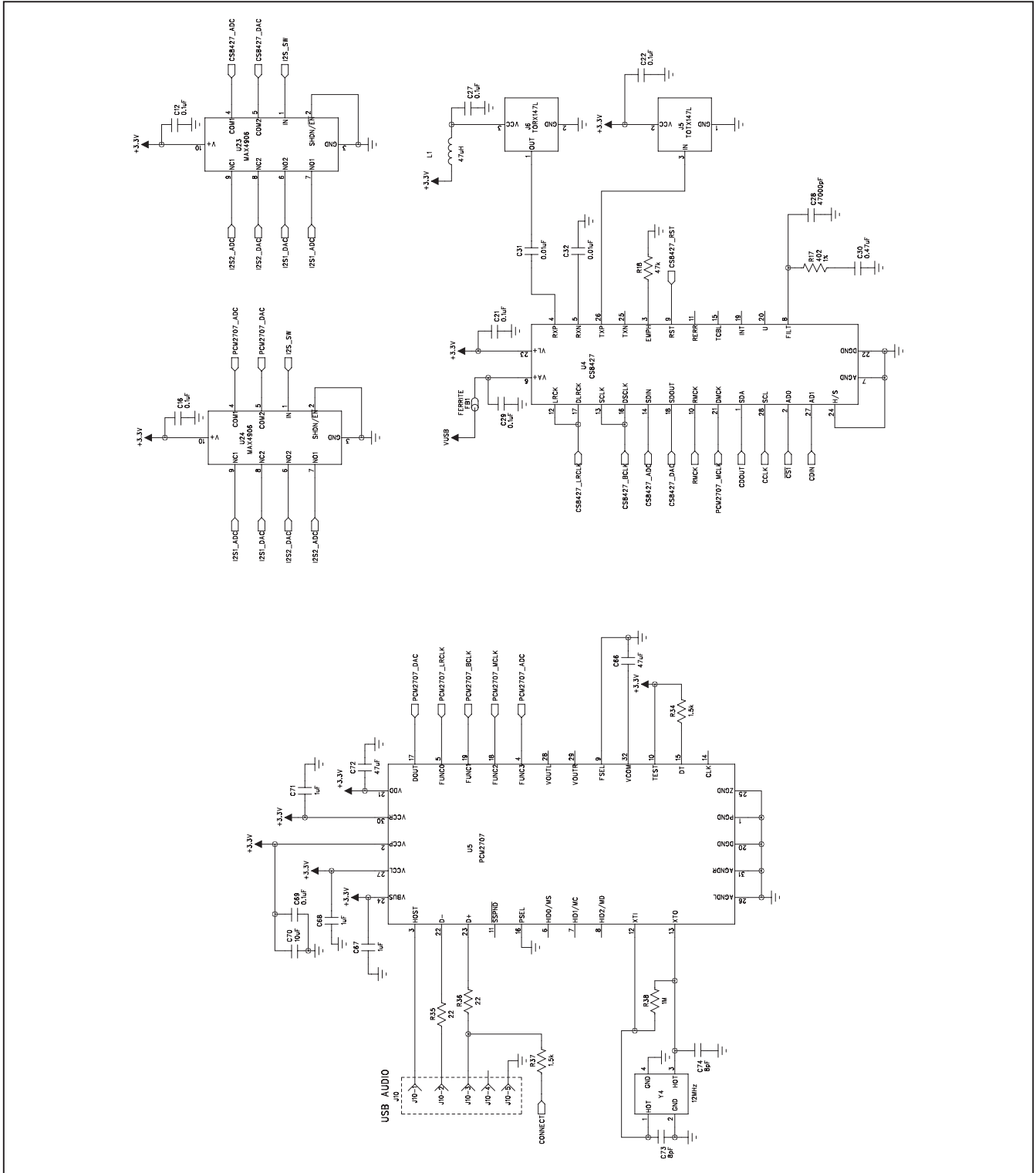
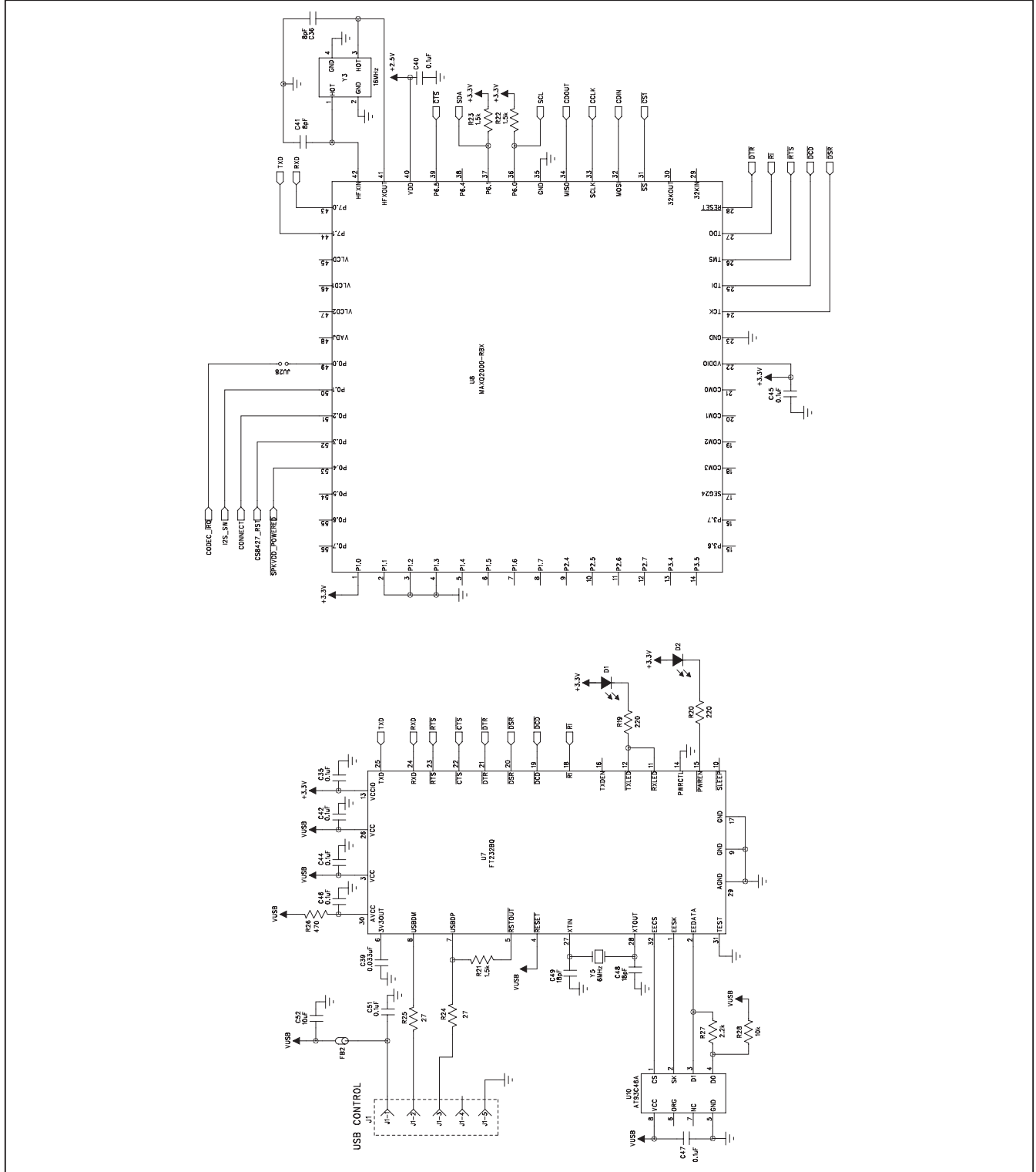

Figure 5c. MAX9888 EV Kit Schematic (Sheet 3 of 5)

MAX9888 Evaluation Kit



MAX9888 Evaluation Kit

Evaluates: **MAX9888**

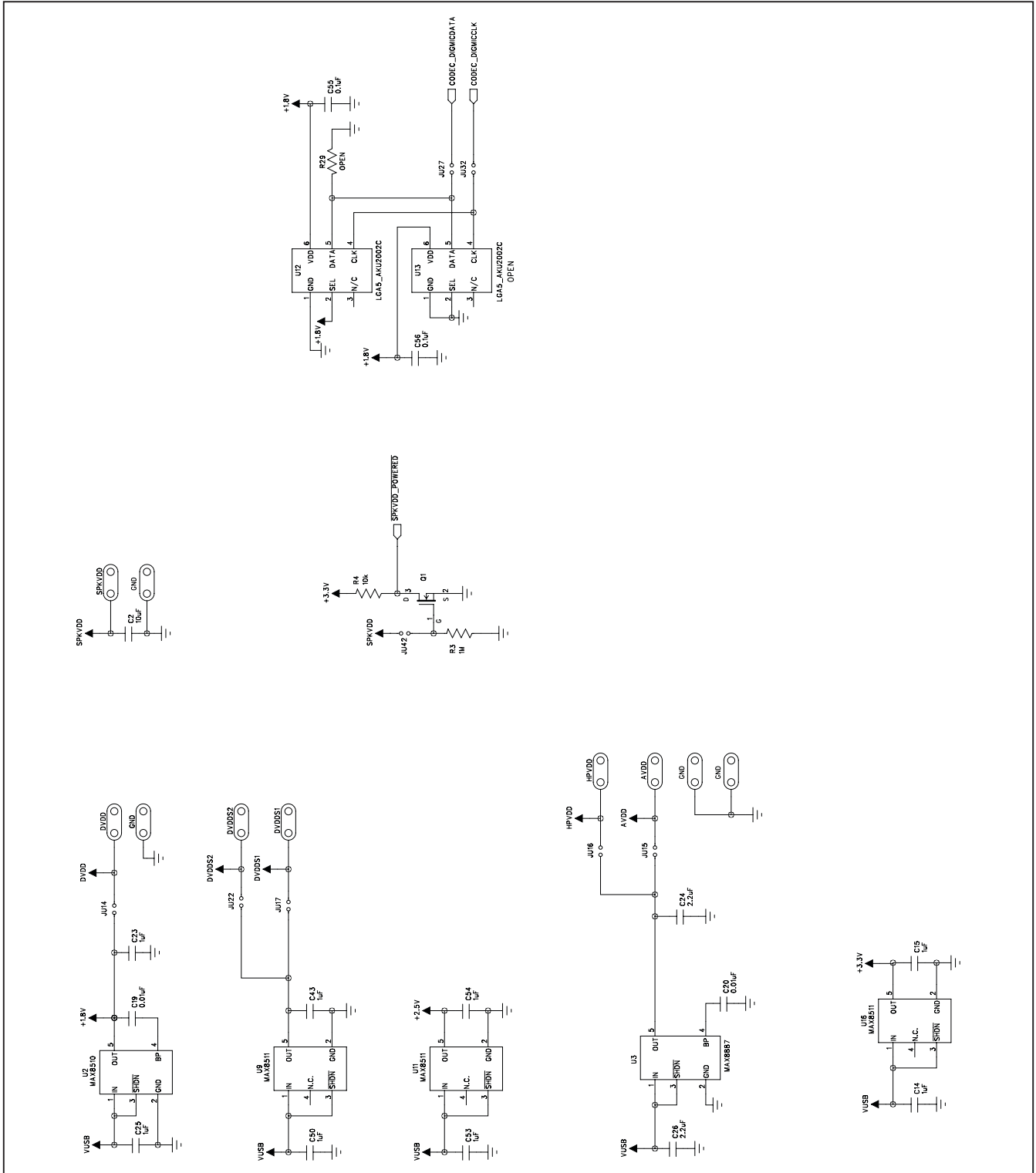

Figure 5e. MAX9888 EV Kit Schematic (Sheet 5 of 5)

MAX9888 Evaluation Kit

Evaluates: MAX9888

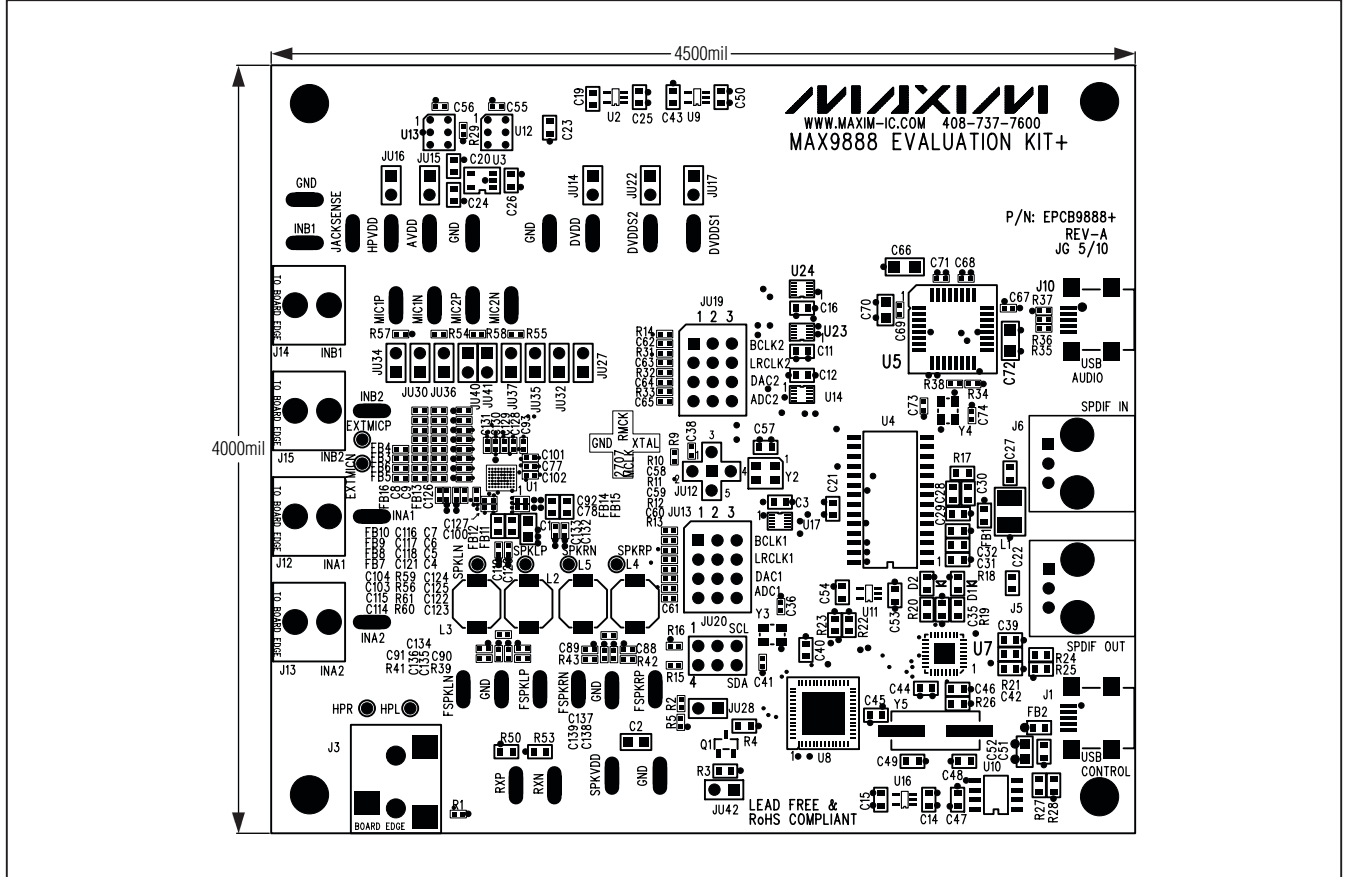

Figure 6. MAX9888 EV Kit Component Placement Guide—Component Side

MAX9888 Evaluation Kit

Evaluates: **MAX9888**

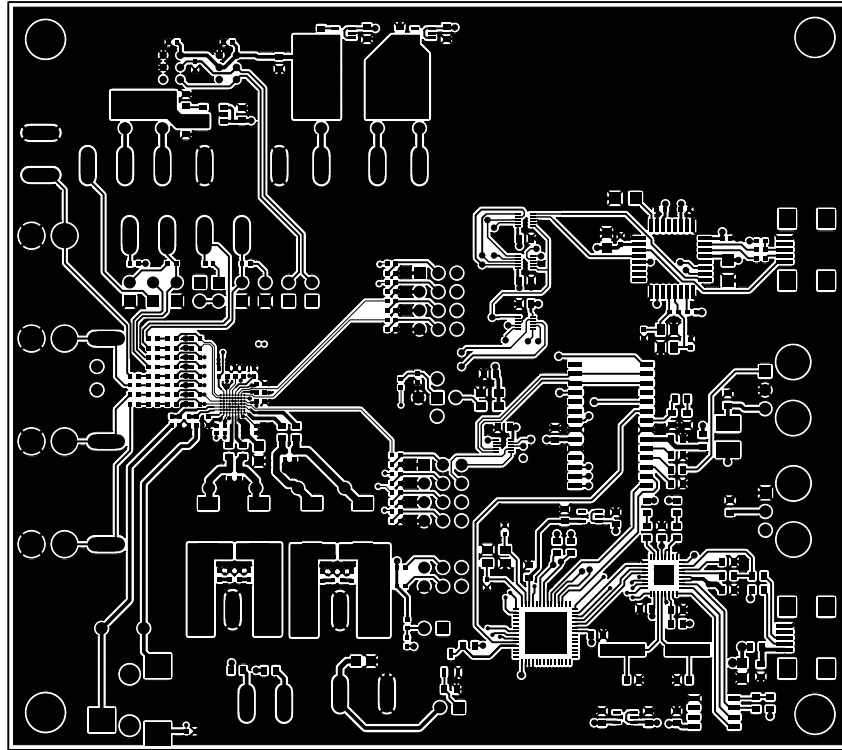

Figure 7. MAX9888 EV Kit PCB Layout—Component Side

MAX9888 Evaluation Kit

Evaluates: MAX9888

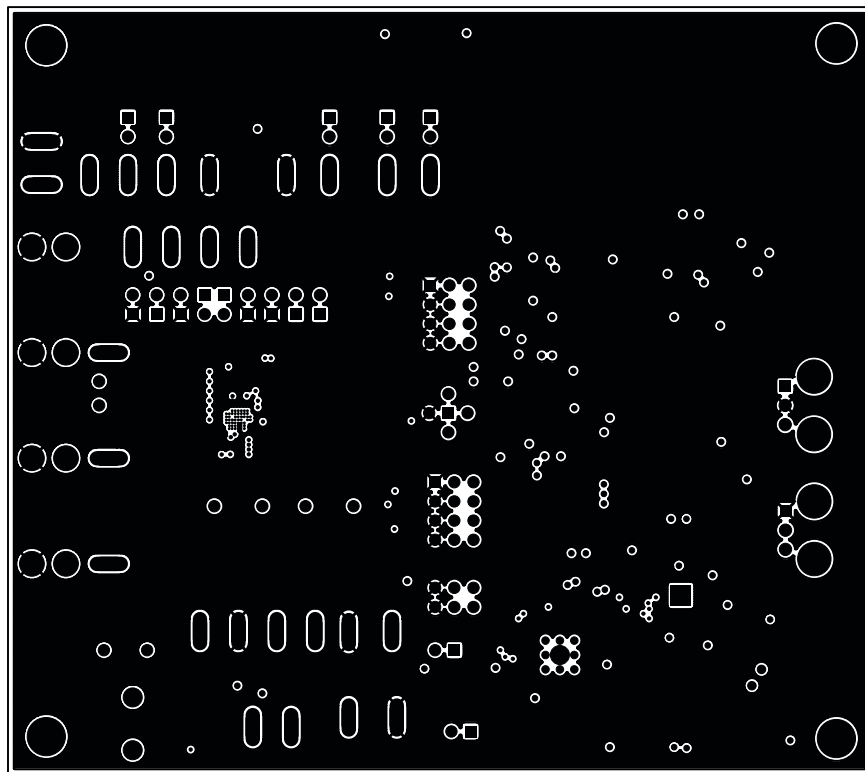

Figure 8. MAX9888 EV Kit PCB Layout—Ground Layer 2

MAX9888 Evaluation Kit

Evaluates: MAX9888

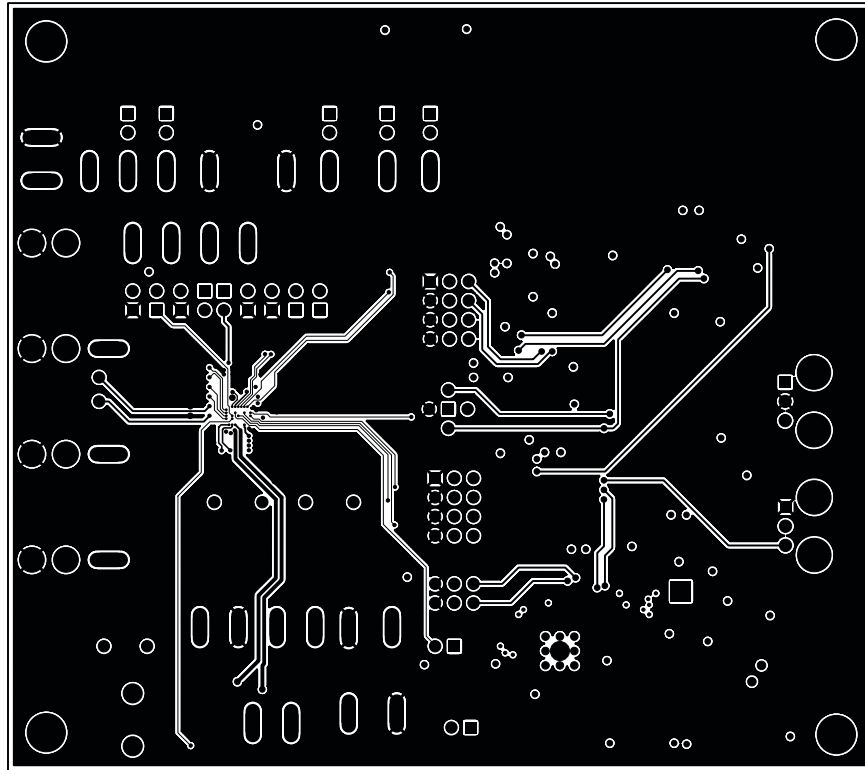

Figure 9. MAX9888 EV Kit PCB Layout—Power Layer 3

MAX9888 Evaluation Kit

Evaluates: MAX9888

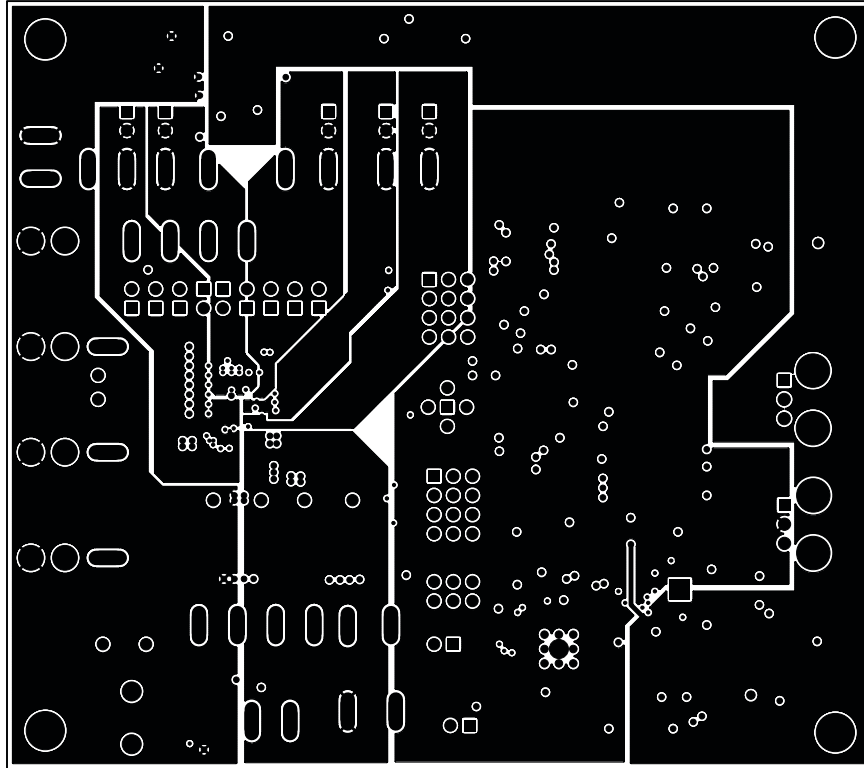

Figure 10. MAX9888 EV Kit PCB Layout—Power Layer 4

MAX9888 Evaluation Kit

Evaluates: MAX9888

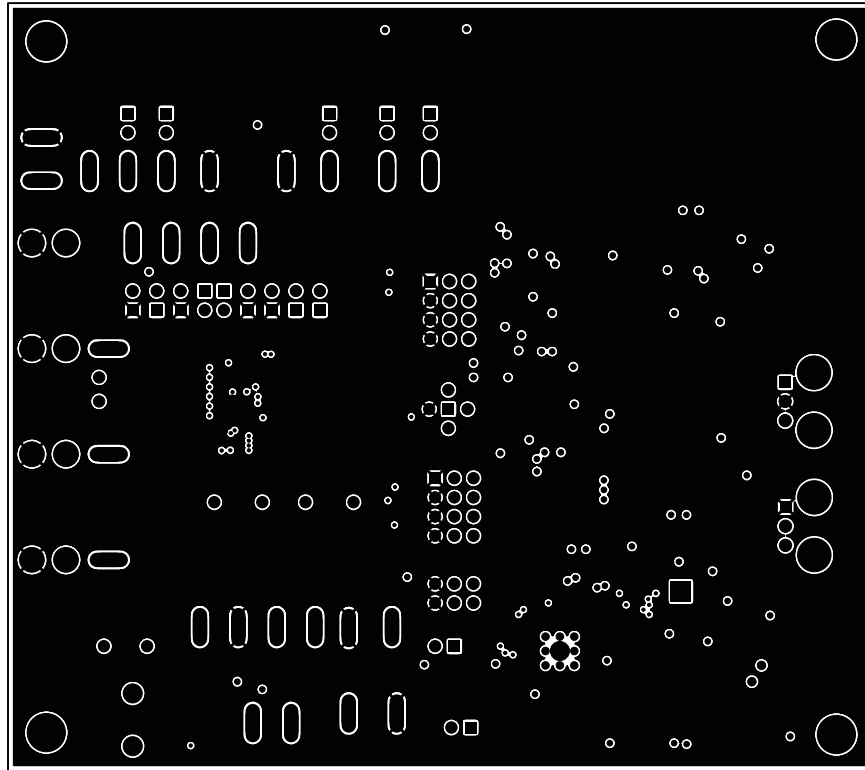

Figure 11. MAX9888 EV Kit PCB Layout—Power Layer 5

MAX9888 Evaluation Kit

Evaluates: MAX9888

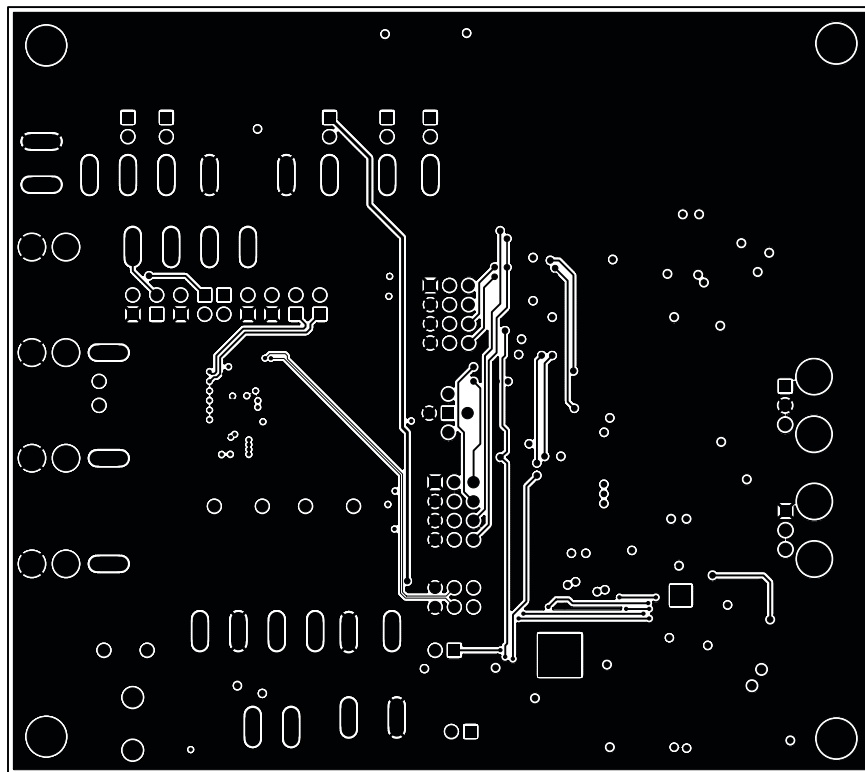

Figure 12. MAX9888 EV Kit PCB Layout—Solder Side

MAX9888 Evaluation Kit

Revision History

REVISION NUMBER	REVISION DATE	DESCRIPTION	PAGES CHANGED
0	8/10	Initial release	—

Evaluates: MAX9888

Maxim cannot assume responsibility for use of any circuitry other than circuitry entirely embodied in a Maxim product. No circuit patent licenses are implied. Maxim reserves the right to change the circuitry and specifications without notice at any time.

Maxim Integrated Products, 120 San Gabriel Drive, Sunnyvale, CA 94086 408-737-7600 _____ 25

AMEYA360

Components Supply Platform

Authorized Distribution Brand :



Website :

Welcome to visit www.ameya360.com

Contact Us :

➤ Address :

401 Building No.5, JiuGe Business Center, Lane 2301, Yishan Rd
Minhang District, Shanghai , China

➤ Sales :

Direct +86 (21) 6401-6692

Email amall@ameya360.com

QQ 800077892

Skype [ameyasales1](#) [ameyasales2](#)

➤ Customer Service :

Email service@ameya360.com

➤ Partnership :

Tel +86 (21) 64016692-8333

Email mkt@ameya360.com