

SM-8 BIPOLAR TRANSISTOR H-BRIDGE

ZHB6792

PRELIMINARY DATA SHEET ISSUE A MAY 1998

FEATURES

- * Compact package
- * Low on state losses
- * Low drive requirements
- * Operates up to 70V supply
- * 1 Amp continuous rating

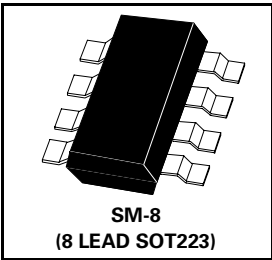

PARTMARKING DETAIL – ZHB6792

ABSOLUTE MAXIMUM RATINGS.

PARAMETER	SYMBOL	NPNs	PNPs	UNIT
Collector-Base Voltage	V_{CBO}	70	-70	V
Collector-Emitter Voltage	V_{CEO}	70	-70	V
Emitter-Base Voltage	V_{EBO}	5	-5	V
Peak Pulse Current	I_{CM}	2	-2	A
Continuous Collector Current	I_C	1	-1	A
Operating and Storage Temperature Range	$T_j; T_{stg}$	-55 to +150		°C

SCHEMATIC DIAGRAM

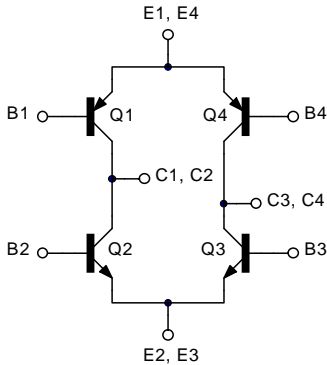

CONNECTION DIAGRAM

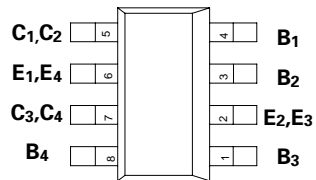

ZHB6792

THERMAL CHARACTERISTICS

PARAMETER	SYMBOL	VALUE	UNIT
Total Power Dissipation at $T_{amb} = 25^{\circ}\text{C}^*$ Any single transistor "on" Q1 and Q3 "on" or Q2 and Q4 "on" equally	P_{tot}	1.25 2	W W
Derate above 25°C^* Any single transistor "on" Q1 and Q3 "on" or Q2 and Q4 "on" equally		10 16	mW/ $^{\circ}\text{C}$ mW/ $^{\circ}\text{C}$
Thermal Resistance - Junction to Ambient* Any single transistor "on" Q1 and Q3 "on" or Q2 and Q4 "on" equally		100 62.5	$^{\circ}\text{C}/\text{W}$ $^{\circ}\text{C}/\text{W}$

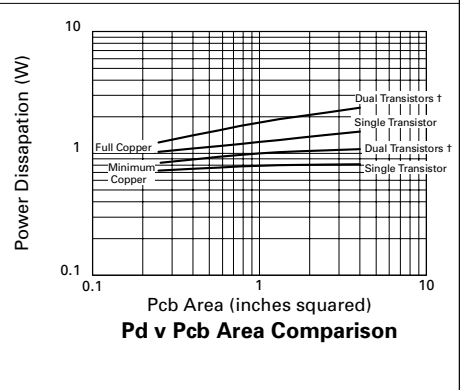
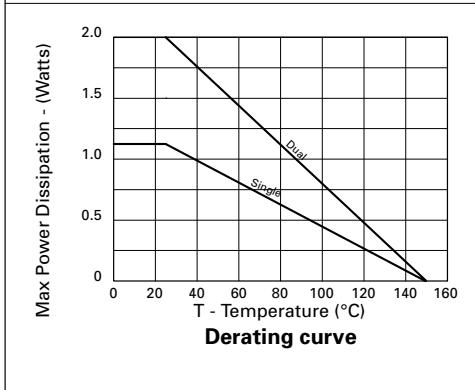
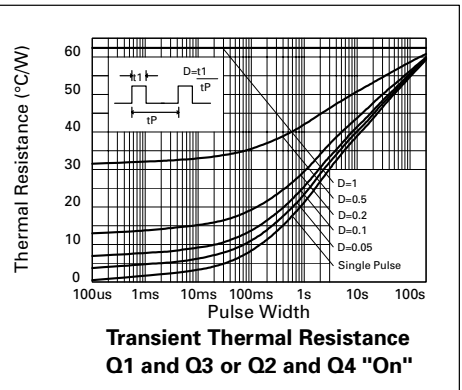
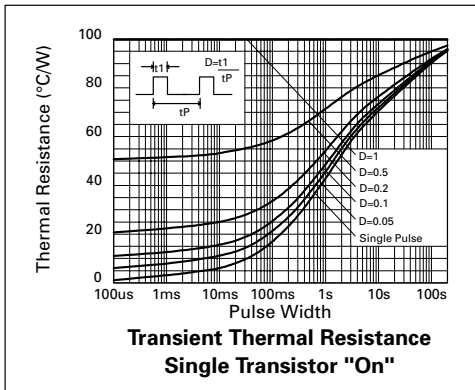

* The power which can be dissipated assuming the device is mounted in a typical manner on a PCB with copper equal to 2 inches square.

† "Two devices on" is the standard operating condition for the bridge. Eg. opposing NPN/PNP pairs turned on.

ZHB6792

NPN TRANSISTORS ELECTRICAL CHARACTERISTICS (at $T_{amb} = 25^{\circ}\text{C}$)

PARAMETER	SYMBOL	MIN.	TYP.	MAX.	UNIT	TEST CONDITIONS.
Breakdown Voltages	$V_{(BR)CBO}$	70			V	$I_C = 100\mu\text{A}$
	$V_{(BR)CEO}$	70			V	$I_C = 10\text{mA}^*$
	$V_{(BR)EBO}$	5			V	$I_E = 100\mu\text{A}$
Cut-Off Currents	I_{CBO}			0.1	μA	$V_{CB} = 55\text{V}$
	I_{EBO}			0.1	μA	$V_{EB} = 4\text{V}$
Saturation Voltages	$V_{CE(sat)}$			0.15 0.5	V V	$I_C = 0.1\text{A}, I_B = 0.5\text{mA}^*$ $I_C = 1\text{A}, I_B = 10\text{mA}^*$
	$V_{BE(sat)}$			0.9	V	$I_C = 1\text{A}, I_B = 10\text{mA}^*$
Base-Emitter Turn-On Voltage	$V_{BE(on)}$			0.9	V	$I_C = 1\text{A}, V_{CE} = 2\text{V}^*$
Static Forward Current Transfer Ratio	h_{FE}	500 400 150				$I_C = 100\text{mA}, V_{CE} = 2\text{V}^*$ $I_C = 500\text{mA}, V_{CE} = 2\text{V}^*$ $I_C = 1\text{A}, V_{CE} = 2\text{V}^*$
Transition Frequency	f_T	150			MHz	$I_C = 50\text{mA}, V_{CE} = 5\text{V}, f = 50\text{MHz}$
Input Capacitance	C_{ibo}		200		pF	$V_{EB} = 0.5\text{V}, f = 1\text{MHz}$
Output Capacitance	C_{obo}		12		pF	$V_{CB} = 10\text{V}, f = 1\text{MHz}$
Switching Times	t_{on}		46		ns	$I_C = 500\text{mA}, I_{B1} = 50\text{mA}$ $I_{B2} = 50\text{mA}, V_{CC} = 10\text{V}$
	t_{off}		1440		ns	

*Measured under pulsed conditions. Pulse width=300 μs . Duty cycle $\leq 2\%$

ZHB6792

PNP TRANSISTORS ELECTRICAL CHARACTERISTICS (at $T_{amb} = 25^{\circ}\text{C}$)

PARAMETER	SYMBOL	MIN.	TYP.	MAX.	UNIT	CONDITIONS.
Collector-Base Breakdown Voltage	$V_{(BR)CBO}$	-75			V	$I_C = -100\mu\text{A}$
Collector-Emitter Breakdown Voltage	$V_{(BR)CEO}$	-70			V	$I_C = -10\text{mA}^*$
Emitter-Base Breakdown Voltage	$V_{(BR)EBO}$	-5			V	$I_E = -100\mu\text{A}$
Collector Cut-Off Current	I_{CBO}			-0.1	μA	$V_{CB} = -40\text{V}$
Emitter Cut-Off Current	I_{EBO}			-0.1	μA	$V_{EB} = -4\text{V}$
Collector-Emitter Saturation Voltage	$V_{CE(sat)}$			-0.45 -0.5	V V	$I_C = -500\text{mA}, I_B = -5\text{mA}^*$ $I_C = -1\text{A}, I_B = -25\text{mA}^*$
Base-Emitter Saturation Voltage	$V_{BE(sat)}$			-0.95	V	$I_C = -1\text{A}, I_B = -25\text{mA}^*$
Base-Emitter Turn-On Voltage	$V_{BE(on)}$		-0.75		V	$I_C = -1\text{A}, V_{CE} = -2\text{V}^*$
Static Forward Current Transfer	h_{FE}	300 250 200		800		$I_C = -10\text{mA}, V_{CE} = -2\text{V}^*$ $I_C = -500\text{mA}, V_{CE} = -2\text{V}^*$ $I_C = -1\text{A}, V_{CE} = -2\text{V}^*$
Transition Frequency	f_T	100			MHz	$I_C = -50\text{mA}, V_{CE} = -5\text{V}$ $f = 50\text{MHz}$
Input Capacitance	C_{ibo}		225		pF	$V_{EB} = -0.5\text{V}, f = 1\text{MHz}$
Output Capacitance	C_{obo}		22		pF	$V_{CB} = -10\text{V}, f = 1\text{MHz}$
Switching Times	t_{on} t_{off}		35 750		ns ns	$I_C = -500\text{mA},$ $I_{B1} = -50\text{mA}$ $I_{B2} = -50\text{mA}, V_{CC} = -10\text{V}$

*Measured under pulsed conditions. Pulse width=300 μs . Duty cycle $\leq 2\%$

ZHB6792

**PNP TRANSISTOR
TYPICAL CHARACTERISTICS**

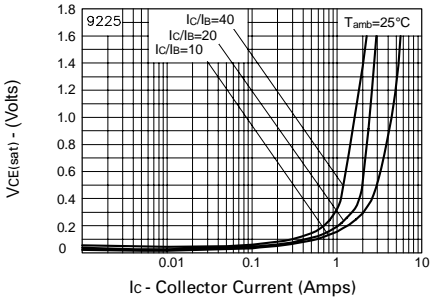

$V_{CE(sat)}$ v I_C

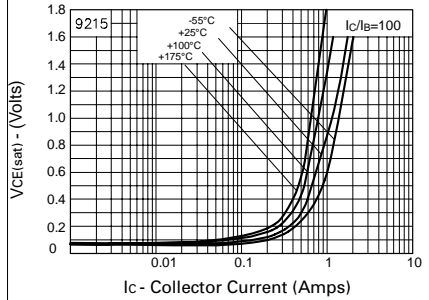

$V_{CE(sat)}$ v I_C

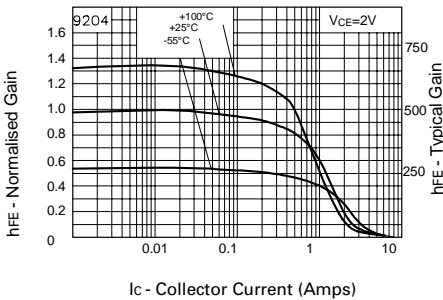

h_{FE} v I_C

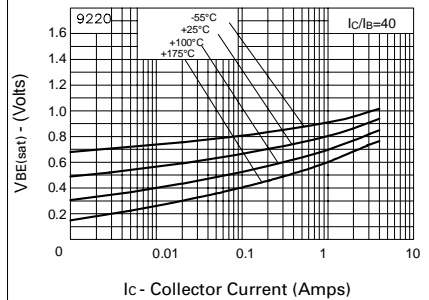

$V_{BE(sat)}$ v I_C

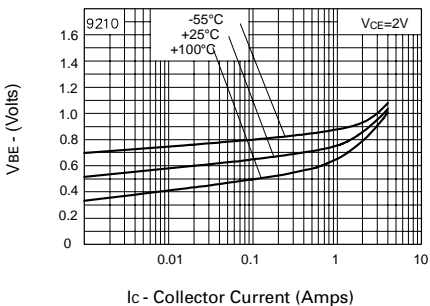

$V_{BE(on)}$ v I_C

ZHB6792

NPN TRANSISTOR TYPICAL CHARACTERISTICS

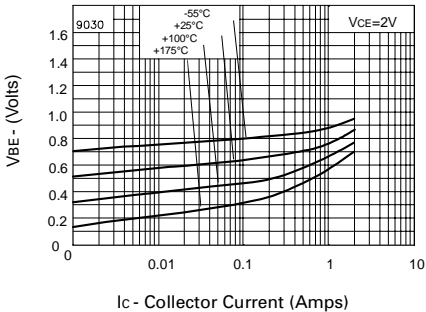
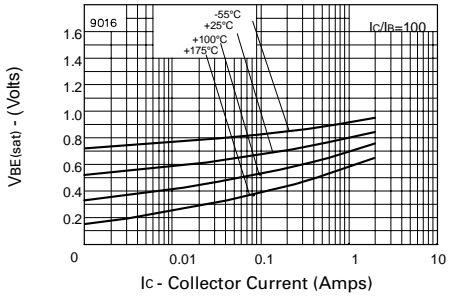
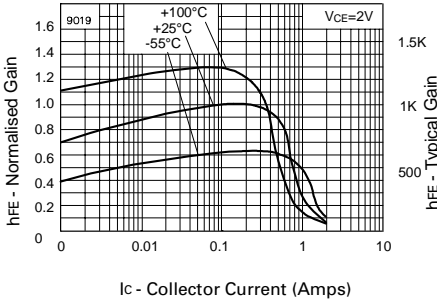
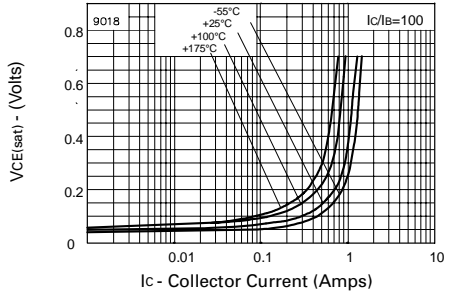
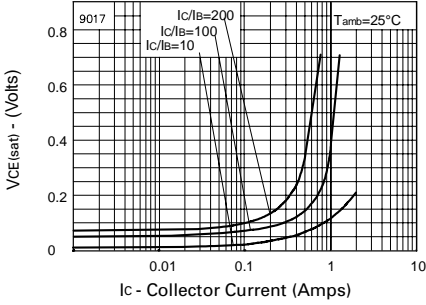

ZHB6792

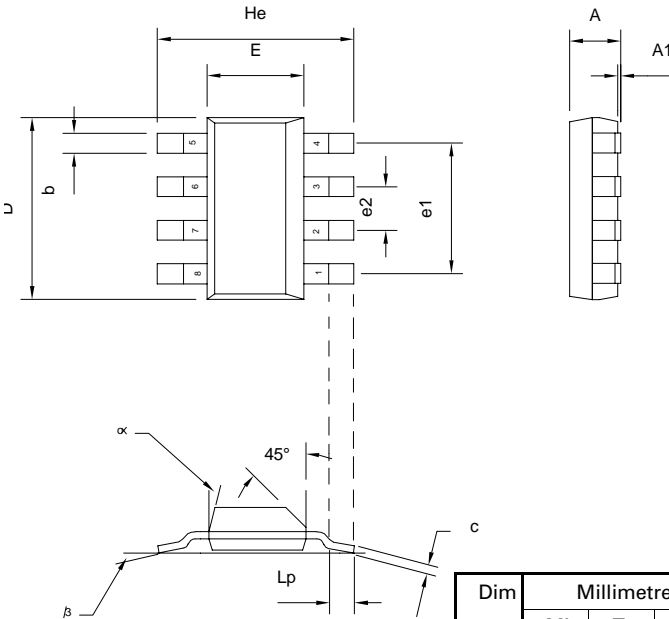

Dim	Millimetres			Inches		
	Min	Typ	Max	Min	Typ	Max
A	-	-	1.7	-	-	0.067
A1	0.02	-	0.1	0.0008	-	0.004
b	-	0.7	-	-	0.028	-
c	0.24	-	0.32	0.009	-	0.013
D	6.3	-	6.7	0.248	-	0.264
E	3.3	-	3.7	0.130	-	0.145
e1	-	4.59	-	-	0.180	-
e2	-	1.53	-	-	0.060	-
He	6.7	-	7.3	0.264	-	0.287
Lp	0.9	-	-	0.035	-	-



Zetex plc.
 Fields New Road, Chadderton, Oldham, OL9-8NP, United Kingdom.
 Telephone: (44)161 622 4422 (Sales), (44)161 622 4444 (General Enquiries)
 Fax: (44)161 622 4420

Zetex GmbH
 Streitfeldstraße 19
 D-81673 München
 Germany
 Telefon: (49) 89 45 49 49 0
 Fax: (49) 89 45 49 49 49

Zetex Inc.
 47 Mall Drive, Unit 4
 Commack NY 11725
 USA
 Telephone: (516) 543-7100
 Fax: (516) 864-7630

Zetex (Asia) Ltd.
 3510 Metroplaza, Tower 2
 Hing Fong Road,
 Kwai Fong, Hong Kong
 Telephone: (852) 26100 611
 Fax: (852) 24250 494

These are supported by
 agents and distributors in
 major countries world-wide
 ©Zetex plc 1998

Internet: <http://www.zetex.com>

This publication is issued to provide outline information only which (unless agreed by the Company in writing) may not be used, applied or reproduced for any purpose or form part of any order or contract or be regarded as a representation relating to the products or services concerned. The Company reserves the right to alter without notice the specification, design, price or conditions of supply of any product or service.

AMEYA360

Components Supply Platform

Authorized Distribution Brand :



Website :

Welcome to visit www.ameya360.com

Contact Us :

➤ Address :

401 Building No.5, JiuGe Business Center, Lane 2301, Yishan Rd
Minhang District, Shanghai , China

➤ Sales :

Direct +86 (21) 6401-6692

Email amall@ameya360.com

QQ 800077892

Skype [ameyasales1](#) [ameyasales2](#)

➤ Customer Service :

Email service@ameya360.com

➤ Partnership :

Tel +86 (21) 64016692-8333

Email mkt@ameya360.com