

RAIL-TO-RAIL OUTPUT CMOS OPERATIONAL AMPLIFIERS WITH SHUTDOWN

Check for Samples: [LMV341](#), [LMV342](#), [LMV344](#)

FEATURES

- 2.7-V and 5-V Performance
- Rail-to-Rail Output Swing
- Input Bias Current...1 pA Typ
- Input Offset Voltage...0.25 mV Typ
- Low Supply Current...100 μ A Typ
- Low Shutdown Current...45 pA Typ
- Gain Bandwidth of 1 MHz Typ
- Slew Rate...1 V/ μ s Typ
- Turn-On Time From Shutdown...5 μ s Typ
- Input Referred Voltage Noise (at 10 kHz)...
20 nV/ $\sqrt{\text{Hz}}$
- ESD Protection Exceeds JESD 22
 - 2000-V Human-Body Model (A114-A)
 - 200-V Machine Model (A115-A)

APPLICATIONS

- Cordless/Cellular Phones
- Consumer Electronics (Laptops, PDAs)
- Audio Pre-Amps for Voice
- Portable/Battery-Powered Electronic Equipment
- Supply-Current Monitoring
- Battery Monitoring
- Buffers
- Filters
- Drivers

DESCRIPTION/ORDERING INFORMATION

The LMV341, LMV342, LMV344 devices are single, dual, and quad CMOS operational amplifiers, respectively, with low voltage, low power, and rail-to-rail output swing capabilities. The PMOS input stage offers an ultra-low input bias current of 1 pA (typ) and an offset voltage of 0.25 mV (typ). The single supply amplifier is designed specifically for low-voltage (2.7 V to 5 V) operation, with a wide common-mode input voltage range that typically extends from -0.2 V to 0.8 V from the positive supply rail. The LMV341 (single) also offers a shutdown (SHDN) pin that can be used to disable the device. In shutdown mode, the supply current is reduced to 33 nA (typ). Additional features of the family are a 20-nV/ $\sqrt{\text{Hz}}$ voltage noise at 10 kHz, 1-MHz unity-gain bandwidth, 1-V/ μ s slew rate, and 100- μ A current consumption per channel.

Offered in both the SOT-23 and smaller SC-70 packages, the LMV341 is suitable for the most space-constraint applications. The LMV342 dual device is offered in the standard SOIC and MSOP packages. An extended industrial temperature range from -40°C to 125°C makes these devices suitable in a wide variety of commercial and industrial environments.

LMV341 . . . DBV (SOT-23) OR DCK (SC-70) PACKAGE
(TOP VIEW)

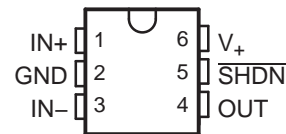

LMV342 . . . D (SOIC) OR DGK (MSOP) PACKAGE
(TOP VIEW)

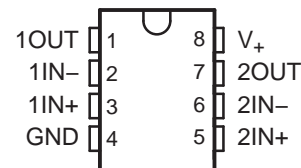

LMV344 . . . D (SOIC) OR PW (TSSOP) PACKAGE
(TOP VIEW)

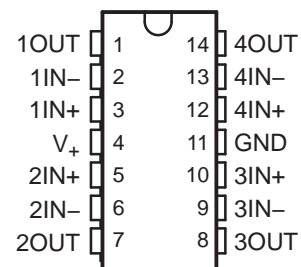

Please be aware that an important notice concerning availability, standard warranty, and use in critical applications of Texas Instruments semiconductor products and disclaimers thereto appears at the end of this data sheet.

ORDERING INFORMATION

T _A	PACKAGE ⁽¹⁾		ORDERABLE PART NUMBER	TOP-SIDE MARKING ⁽²⁾	
-40°C to 125°C	Single	SOT-23 – DBV	Reel of 3000	LMV341IDBVR	RC9_
			Reel of 250	LMV341IDBVT	Product Preview
		SC-70 – DCK	Reel of 3000	LMV341IDCKR	R4_
			Reel of 250	LMV341IDCKT	Product Preview
	Dual	SOIC – D	Tube of 75	LMV342ID	MV342I
			Reel of 2500	LMV342IDR	
		MSOP/VSSOP – DGK	Reel of 250	LMV342IDGK	RP_
			Reel of 2500	LMV342IDGKR	
	Quad	SOIC – D	Tube of 50	LMV344ID	LMV344I
			Reel of 2500	LMV344IDR	
TSSOP – PW		Tube of 90	LMV344IPW	MV344I	
		Reel of 2000	LMV344IPWR		

- (1) Package drawings, standard packing quantities, thermal data, symbolization, and PCB design guidelines are available at www.ti.com/sc/package.
- (2) DBV/DCK/DGK: The actual top-side marking has one additional character that designates the wafer fab/assembly site.

Figure 1. APPLICATION CIRCUIT: SAMPLE-AND-HOLD CIRCUIT

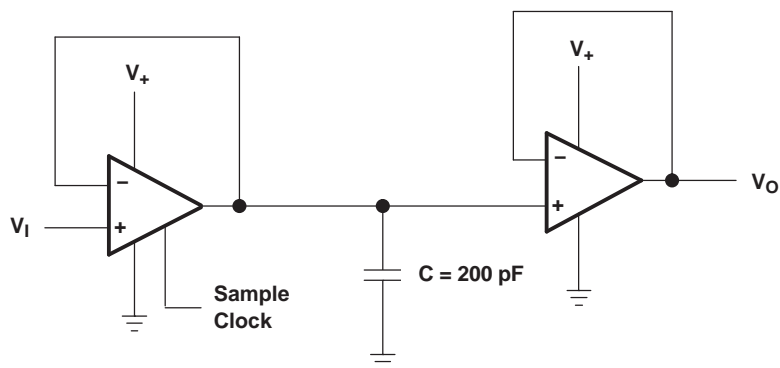

ABSOLUTE MAXIMUM RATINGS⁽¹⁾

over operating free-air temperature range (unless otherwise noted)

		MIN	MAX	UNIT	
V ₊	Supply voltage ⁽²⁾		5.5	V	
V _{ID}	Differential input voltage ⁽³⁾		±5.5	V	
V _I	Input voltage range (either input)	0	5.5	V	
θ _{JA}	Package thermal impedance ^{(4) (5)}	D package	8 pin	97	°C/W
			14 pin	86	
		DBV package		165	
		DCK package		259	
		PW package		113	
T _J	Operating virtual junction temperature		150	°C	
T _{stg}	Storage temperature range	–65	150	°C	

- (1) Stresses beyond those listed under “absolute maximum ratings” may cause permanent damage to the device. These are stress ratings only, and functional operation of the device at these or any other conditions beyond those indicated under “recommended operating conditions” is not implied. Exposure to absolute-maximum-rated conditions for extended periods may affect device reliability.
- (2) All voltage values (except differential voltages and V₊ specified for the measurement of I_{OS}) are with respect to the network GND.
- (3) Differential voltages are at IN+ with respect to IN–.
- (4) Maximum power dissipation is a function of T_{J(max)}, θ_{JA}, and T_A. The maximum allowable power dissipation at any allowable ambient temperature is P_D = (T_{J(max)} – T_A)/θ_{JA}. Operating at the absolute maximum T_J of 150°C can affect reliability.
- (5) The package thermal impedance is calculated in accordance with JESD 51-7.

RECOMMENDED OPERATING CONDITIONS

		MIN	MAX	UNIT
V ₊	Supply voltage (single-supply operation)	2.5	5.5	V
T _A	Operating free-air temperature	–40	125	°C

ESD PROTECTION

TEST CONDITIONS	TYP	UNIT
Human-Body Model	2000	V
Machine Model	200	V

ELECTRICAL CHARACTERISTICS

$V_+ = 2.7\text{ V}$, $GND = 0\text{ V}$, $V_{IC} = V_O = V_+/2$, $R_L > 1\text{ M}\Omega$ (unless otherwise noted)

PARAMETER		TEST CONDITIONS	T_A	MIN	TYP ⁽¹⁾	MAX	UNIT
V_{IO}	Input offset voltage		25°C		0.25	4	mV
			Full range			4.5	
α_{VIO}	Average temperature coefficient of input offset voltage		Full range		1.7		$\mu\text{V}/^\circ\text{C}$
I_{IB}	Input bias current		25°C		1	120	pA
			–40°C to 85°C			250	
			–40°C to 125°C			3	nA
I_{IO}	Input offset current		25°C		6.6		fA
CMRR	Common-mode rejection ratio	$0 \leq V_{ICR} \leq 1.7\text{ V}$	25°C	56	80		dB
		$0 \leq V_{ICR} \leq 1.6\text{ V}$	Full range	50			
k_{SVR}	Supply-voltage rejection ratio	$2.7\text{ V} \leq V_+ \leq 5\text{ V}$	25°C	65	82		dB
			Full range	60			
V_{ICR}	Common-mode input voltage range	CMRR $\geq 50\text{ dB}$	25°C	0	–0.2 to 1.9	1.7	V
A_V	Large-signal voltage gain ⁽²⁾	$R_L = 10\text{ k}\Omega$ to 1.35 V	25°C	78	113		dB
			Full range	70			
		$R_L = 2\text{ k}\Omega$ to 1.35 V	25°C	72	103		
			Full range	64			
V_O	Output swing (delta from supply rails)	$R_L = 2\text{ k}\Omega$ to 1.35 V	Low level	25°C	24	60	mV
				Full range		95	
			High level	25°C	26	60	
				Full range		95	
		$R_L = 10\text{ k}\Omega$ to 1.35 V	Low level	25°C	5	30	
				Full range		40	
			High level	25°C	5.3	30	
				Full range		40	
I_{CC}	Supply current (per channel)		25°C	100	170	μA	
			Full range		230		
I_{OS}	Output short-circuit current	Sourcing	LMV341, LMV342	25°C	20	32	mA
			LMV344		18	24	
		Sinking			15	24	
SR	Slew rate	$R_L = 10\text{ k}\Omega$ ⁽³⁾	25°C		1		V/ μs
GBM	Unity-gain bandwidth	$R_L = 10\text{ k}\Omega$, $C_L = 200\text{ pF}$	25°C		1		MHz
Φ_m	Phase margin	$R_L = 100\text{ k}\Omega$	25°C		72		deg
G_m	Gain margin	$R_L = 100\text{ k}\Omega$	25°C		20		dB
V_n	Equivalent input noise voltage	$f = 1\text{ kHz}$	25°C		40		$\text{nV}/\sqrt{\text{Hz}}$
I_n	Equivalent input noise current	$f = 1\text{ kHz}$	25°C		0.001		$\text{pA}/\sqrt{\text{Hz}}$
THD	Total harmonic distortion	$f = 1\text{ kHz}$, $A_V = 1$, $R_L = 600\ \Omega$, $V_I = 1\text{ V}_{PP}$	25°C		0.017		%

(1) Typical values represent the most likely parametric norm.

(2) $GND + 0.2\text{ V} \leq V_O \leq V_+ - 0.2\text{ V}$

(3) Connected as voltage follower with $2 \cdot V_{PP}$ step input. Number specified is the slower of the positive and negative slew rates.

SHUTDOWN CHARACTERISTICS

 $V_+ = 2.7\text{ V}$, $GND = 0\text{ V}$, $V_{IC} = V_O = V_+/2$, $R_L > 1\text{ M}\Omega$ (unless otherwise noted)

PARAMETER		TEST CONDITIONS	T_A	MIN	TYP	MAX	UNIT
$I_{CC(SHDN)}$	Supply current in shutdown mode	$V_{SD} = 0\text{ V}$	25°C		0.045	1000	nA
			Full range			1.5	μA
$t_{(on)}$	Amplifier turn-on time		25°C		5		μs
V_{SD}	Shutdown pin voltage range	ON mode	25°C	1.7 to 2.7	2.4 to 2.7		V
		Shutdown mode		0 to 1	0 to 0.8		

ELECTRICAL CHARACTERISTICS

$V_+ = 5\text{ V}$, $\text{GND} = 0\text{ V}$, $V_{\text{IC}} = V_{\text{O}} = V_+/2$, $R_{\text{L}} > 1\text{ M}\Omega$ (unless otherwise noted)

PARAMETER		TEST CONDITIONS		T_{A}	MIN	TYP ⁽¹⁾	MAX	UNIT
V_{IO}	Input offset voltage			25°C		0.25	4	mV
				Full range			4.5	
α_{VIO}	Average temperature coefficient of input offset voltage			Full range		1.9		$\mu\text{V}/^\circ\text{C}$
I_{IB}	Input bias current			25°C		1	200	pA
				–40°C to 85°C			375	
				–40°C to 125°C				5
I_{IO}	Input offset current			25°C		6.6		fA
CMRR	Common-mode rejection ratio	$0 \leq V_{\text{ICR}} \leq 4\text{ V}$		25°C	56	86		dB
		$0 \leq V_{\text{ICR}} \leq 3.9\text{ V}$		Full range	50			
k_{SVR}	Supply-voltage rejection ratio	$2.7\text{ V} \leq V_+ \leq 5\text{ V}$		25°C	65	82		dB
				Full range	60			
V_{ICR}	Common-mode input voltage range	CMRR $\geq 50\text{ dB}$		25°C	0	–0.2 to 4.2	4	V
A_{V}	Large-signal voltage gain ⁽²⁾	$R_{\text{L}} = 10\text{ k}\Omega$ to 2.5 V		25°C	78	116		dB
				Full range	70			
		$R_{\text{L}} = 2\text{ k}\Omega$ to 2.5 V		25°C	72	107		
				Full range	64			
V_{O}	Output swing (delta from supply rails)	$R_{\text{L}} = 2\text{ k}\Omega$ to 2.5 V	Low level	25°C		32	60	mV
				Full range			95	
			High level	25°C		34	60	
				Full range			95	
		$R_{\text{L}} = 10\text{ k}\Omega$ to 2.5 V	Low level	25°C		7	30	
				Full range			40	
			High level	25°C		7	30	
				Full range			40	
I_{CC}	Supply current (per channel)			25°C		107	200	μA
				Full range			260	
I_{OS}	Output short-circuit current	Sourcing	LMV341, LMV342	25°C	85	113		mA
			LMV344					
		Sinking						
SR	Slew rate	$R_{\text{L}} = 10\text{ k}\Omega$ ⁽³⁾		25°C		1		V/ μs
GBM	Unity-gain bandwidth	$R_{\text{L}} = 10\text{ k}\Omega$, $C_{\text{L}} = 200\text{ pF}$		25°C		1		MHz
Φ_{m}	Phase margin	$R_{\text{L}} = 100\text{ k}\Omega$		25°C		70		deg
G_{m}	Gain margin	$R_{\text{L}} = 100\text{ k}\Omega$		25°C		20		dB
V_{n}	Equivalent input noise voltage	$f = 1\text{ kHz}$		25°C		39		$\text{nV}/\sqrt{\text{Hz}}$
I_{n}	Equivalent input noise current	$f = 1\text{ kHz}$		25°C		0.001		$\text{pA}/\sqrt{\text{Hz}}$
THD	Total harmonic distortion	$f = 1\text{ kHz}$, $A_{\text{V}} = 1$, $R_{\text{L}} = 600\ \Omega$, $V_{\text{I}} = 1\text{ V}_{\text{PP}}$		25°C		0.012		%

(1) Typical values represent the most likely parametric norm.

(2) $\text{GND} + 0.2\text{ V} \leq V_{\text{O}} \leq V_+ - 0.2\text{ V}$

(3) Connected as voltage follower with $2 \cdot V_{\text{PP}}$ step input. Number specified is the slower of the positive and negative slew rates.

SHUTDOWN CHARACTERISTICS

 $V_+ = 5\text{ V}$, $\text{GND} = 0\text{ V}$, $V_{IC} = V_O = V_+/2$, $R_L > 1\text{ M}\Omega$ (unless otherwise noted)

PARAMETER		TEST CONDITIONS	T_A	MIN	TYP	MAX	UNIT
$I_{CC(\text{SHDN})}$	Supply current in shutdown mode	$V_{SD} = 0\text{ V}$	25°C		0.033	1	μA
			Full range			1.5	
$t_{(\text{on})}$	Amplifier turn-on time		25°C		5		μs
V_{SD}	Shutdown pin voltage range	ON mode	25°C		3.1 to 5	4.5 to 5	V
		Shutdown mode			0 to 1	0 to 0.8	

TYPICAL CHARACTERISTICS

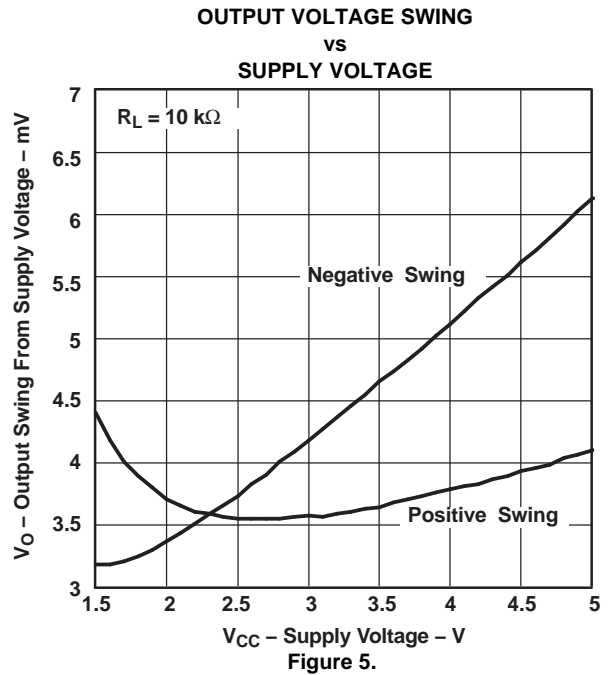
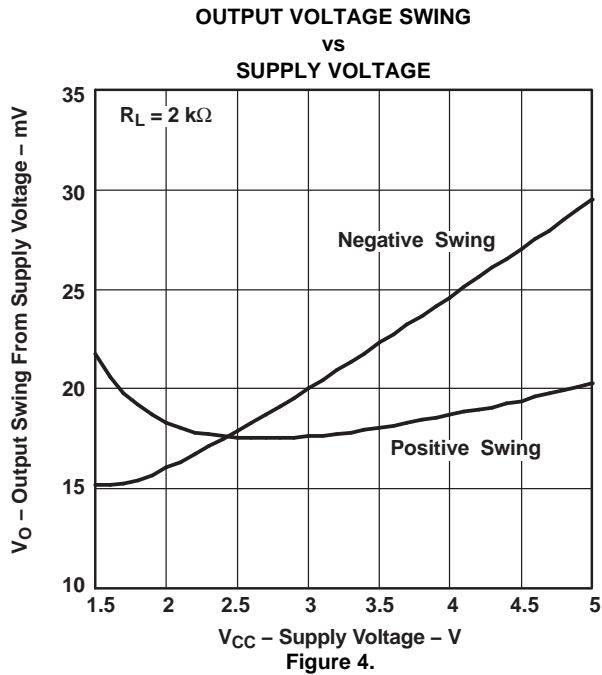
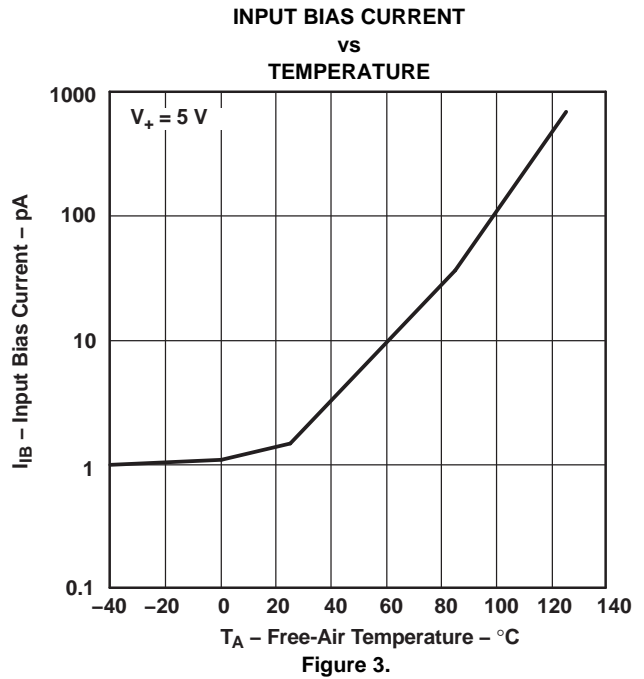
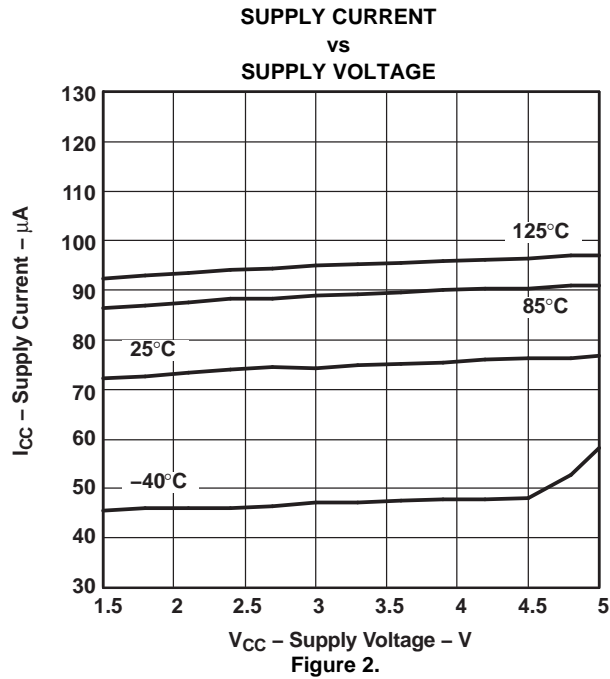

TYPICAL CHARACTERISTICS (continued)

SOURCE CURRENT vs OUTPUT VOLTAGE

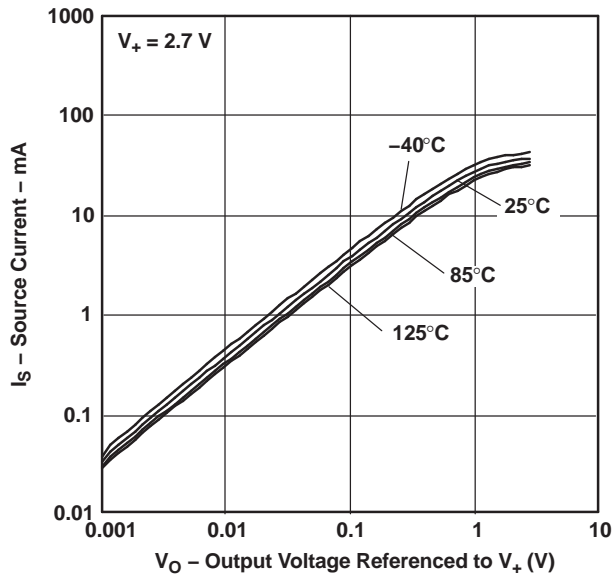

Figure 6.

SOURCE CURRENT vs OUTPUT VOLTAGE

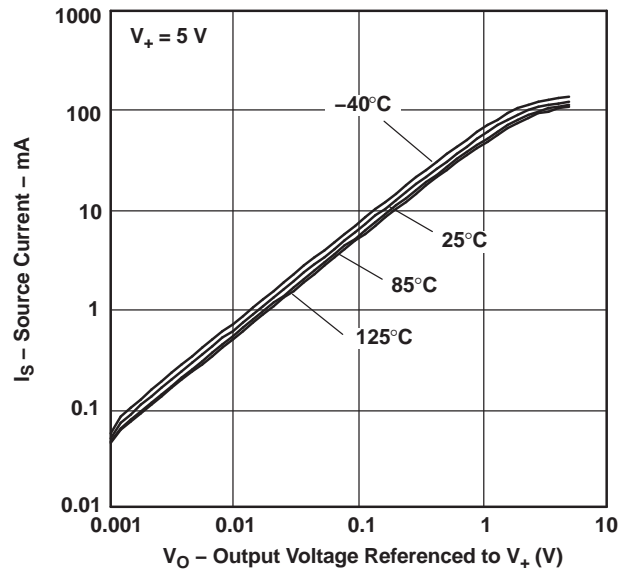

Figure 7.

SINK CURRENT vs OUTPUT VOLTAGE

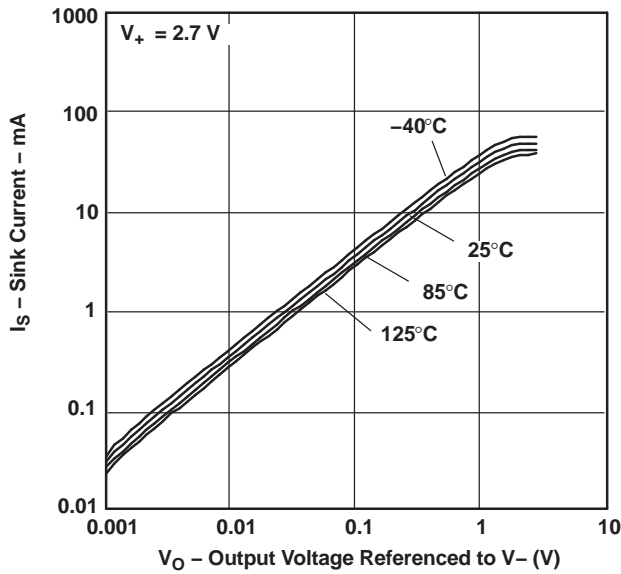

Figure 8.

SINK CURRENT vs OUTPUT VOLTAGE

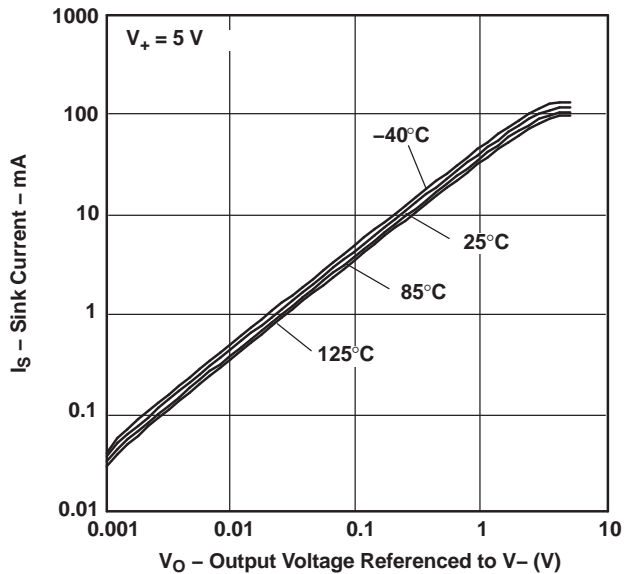

Figure 9.

TYPICAL CHARACTERISTICS (continued)

**OFFSET VOLTAGE
vs
COMMON-MODE VOLTAGE**

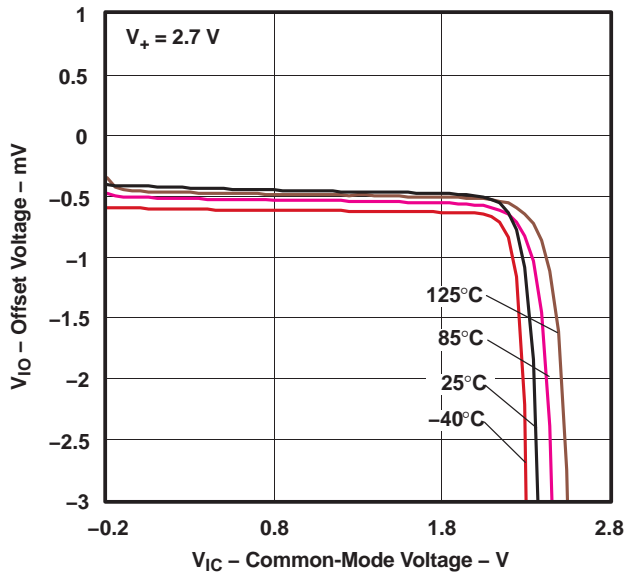

Figure 10.

**OFFSET VOLTAGE
vs
COMMON-MODE VOLTAGE**

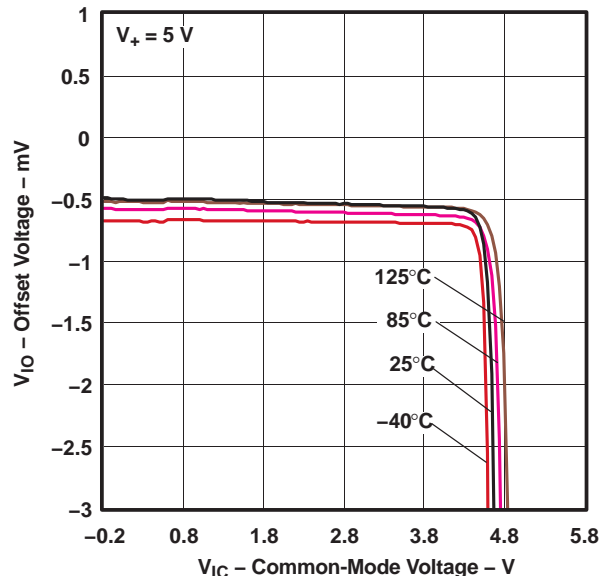

Figure 11.

**INPUT VOLTAGE
vs
OUTPUT VOLTAGE**

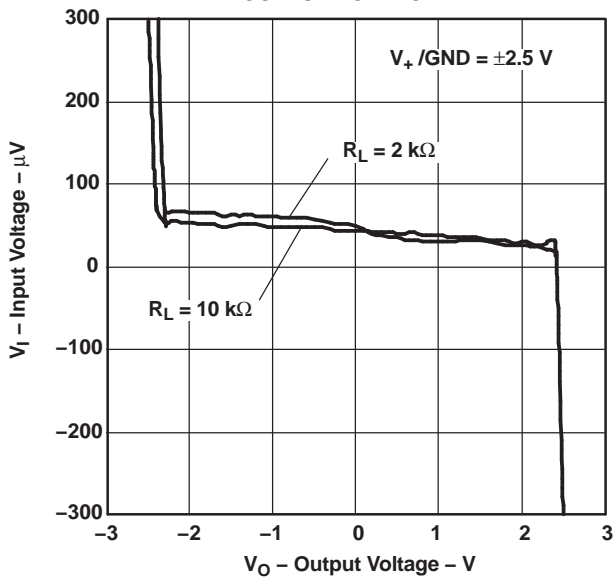

Figure 12.

**INPUT VOLTAGE
vs
OUTPUT VOLTAGE**

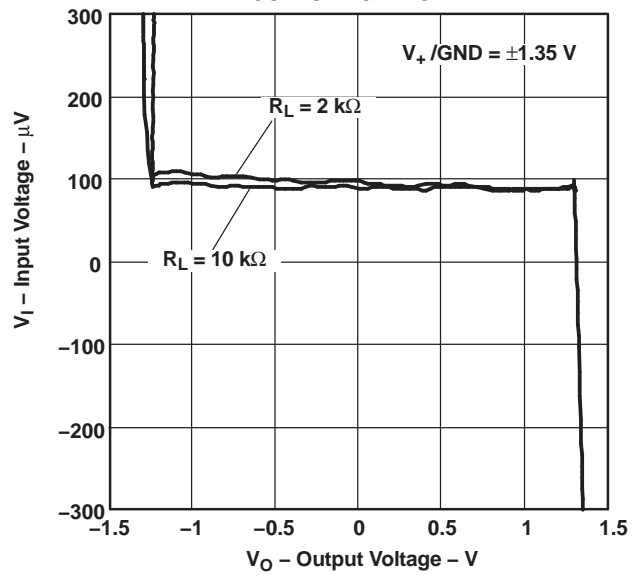

Figure 13.

TYPICAL CHARACTERISTICS (continued)

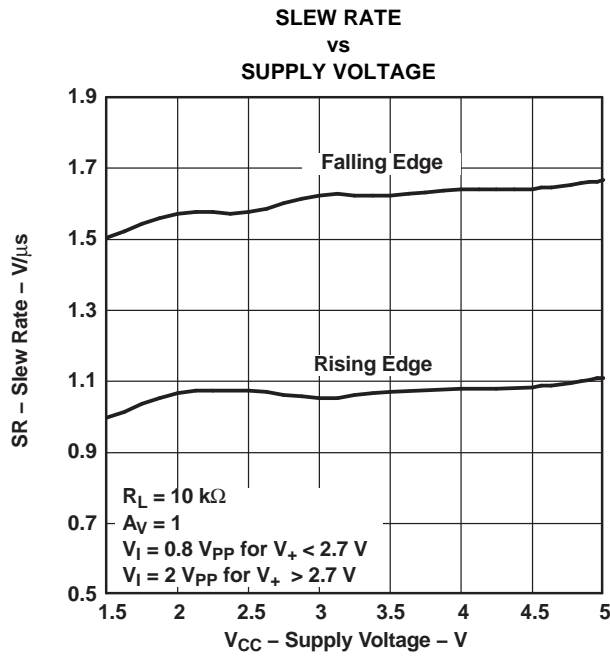

Figure 14.

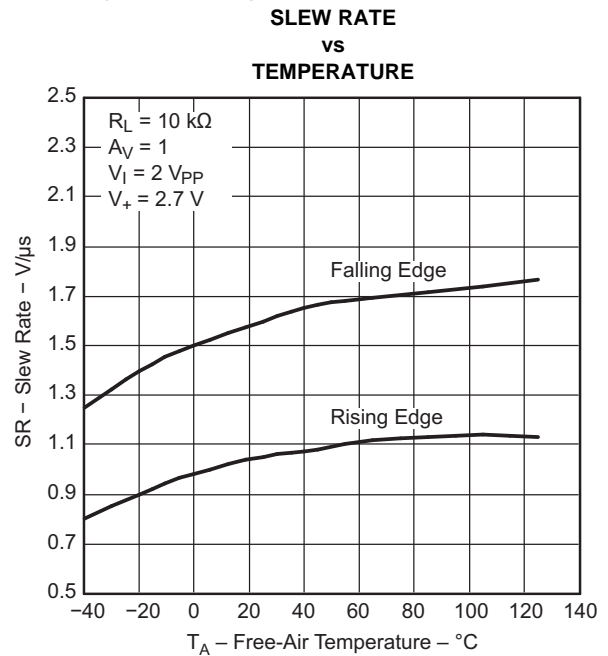

Figure 15.

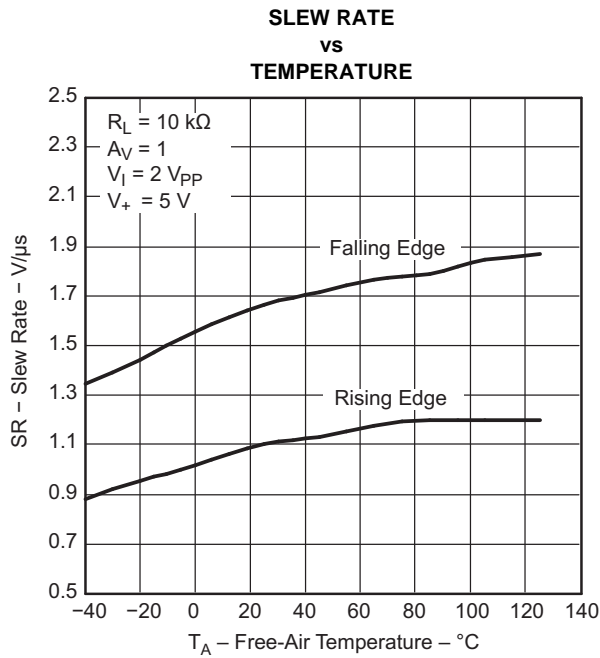

Figure 16.

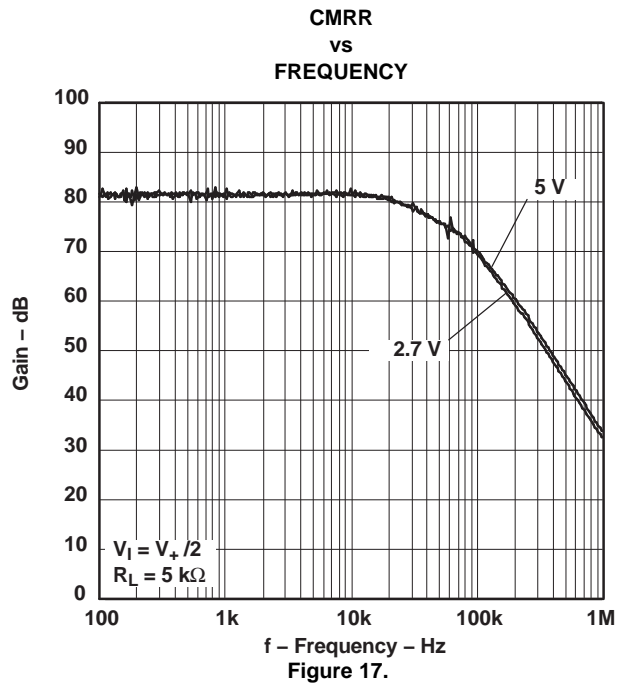
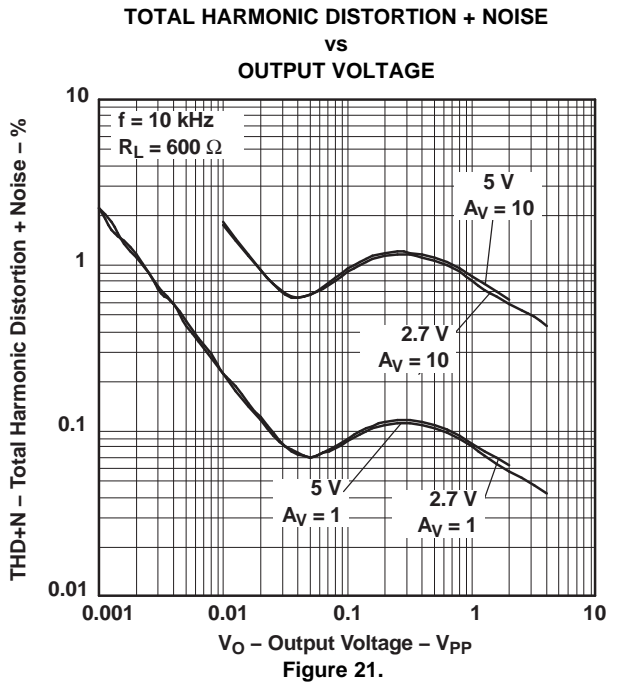
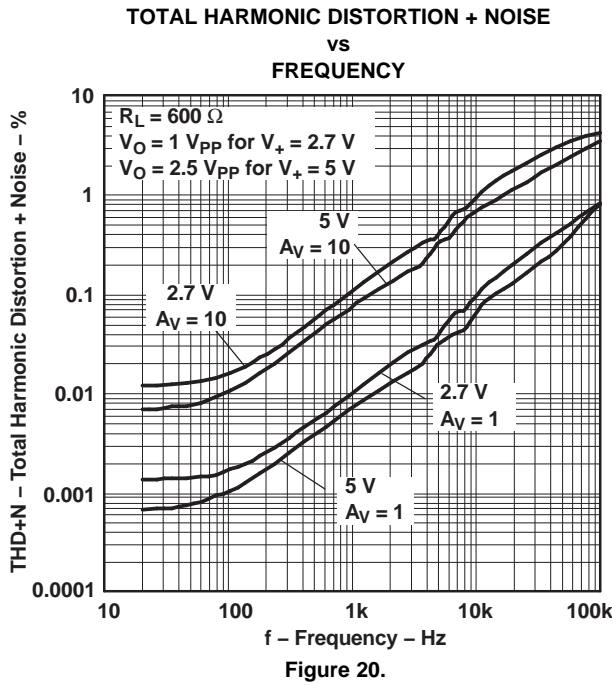
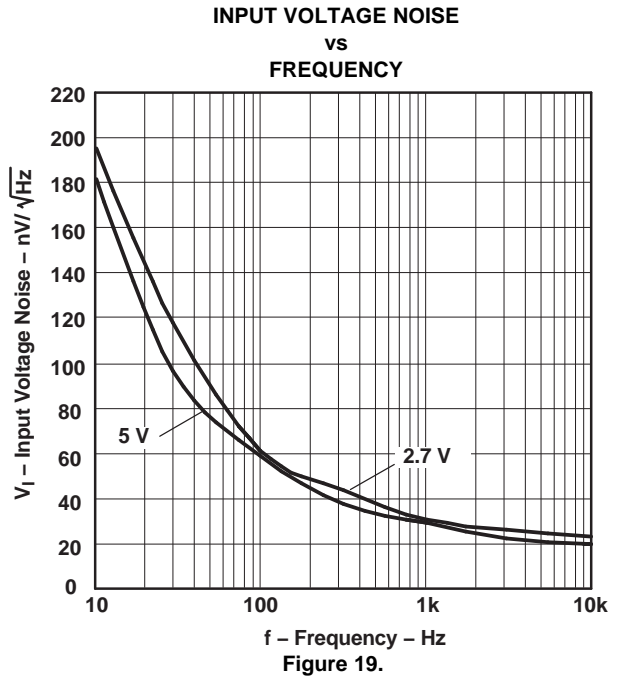
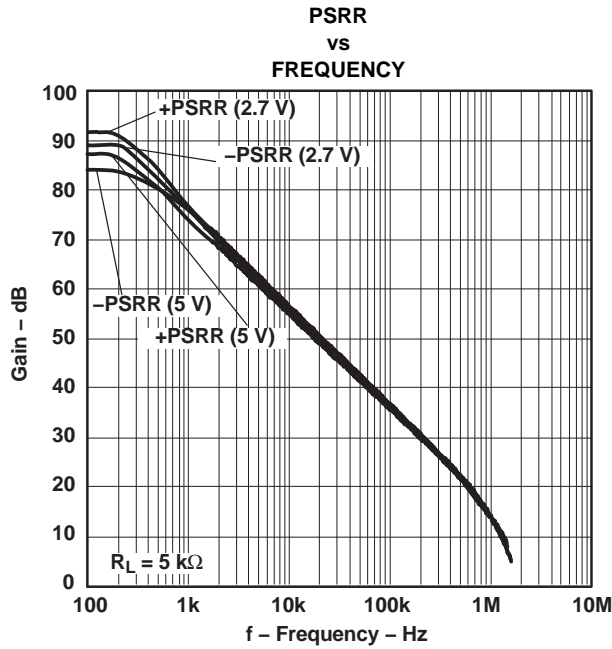

Figure 17.

TYPICAL CHARACTERISTICS (continued)



TYPICAL CHARACTERISTICS (continued)

GAIN AND PHASE MARGIN

vs

FREQUENCY

($T_A = -40^\circ\text{C}, 25^\circ\text{C}, 125^\circ\text{C}$)

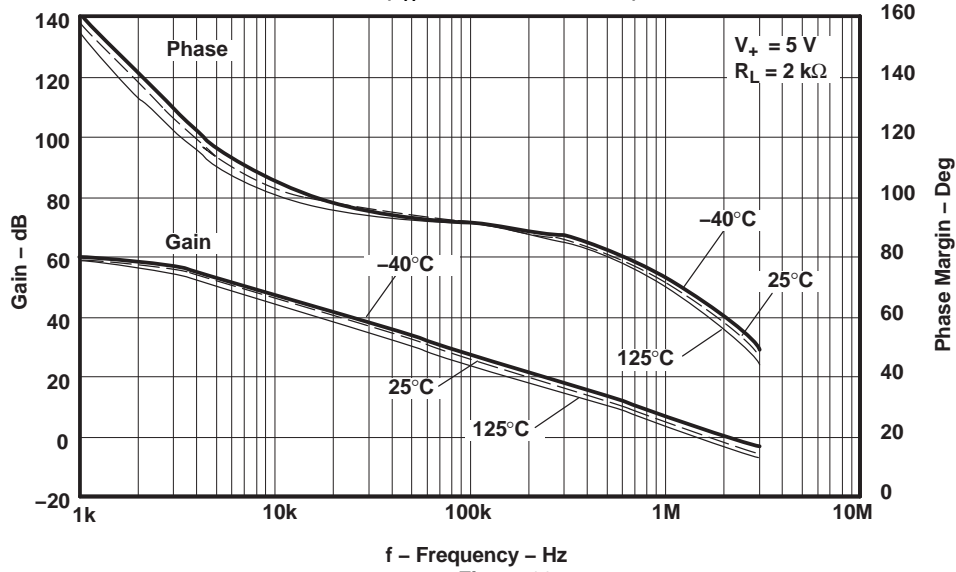

GAIN AND PHASE MARGIN

vs

FREQUENCY

($R_L = 600\ \Omega, 2\text{ k}\Omega, 100\text{ k}\Omega$)

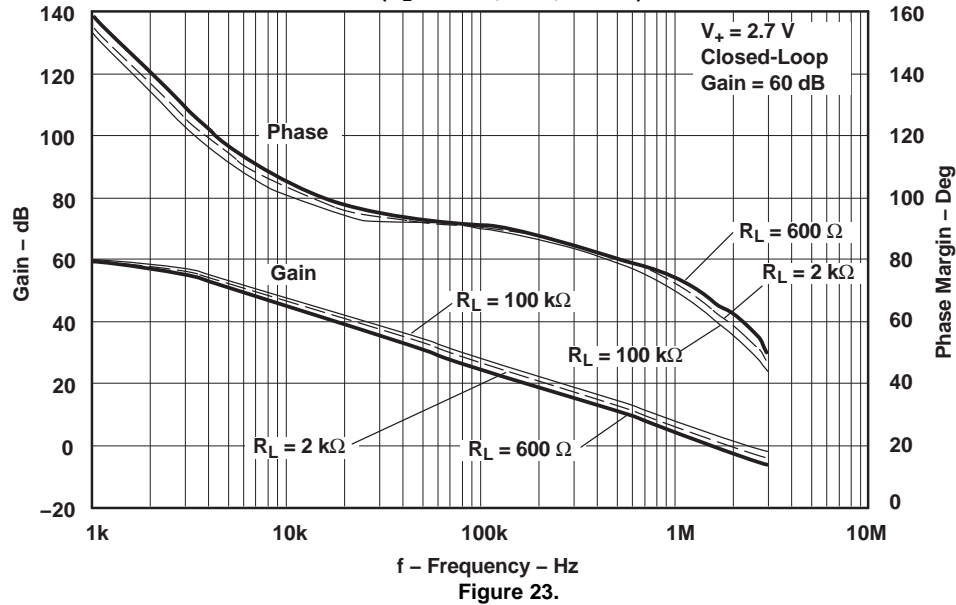

TYPICAL CHARACTERISTICS (continued)

GAIN AND PHASE MARGIN

vs

FREQUENCY

($R_L = 600 \Omega, 2 \text{ k}\Omega, 100 \text{ k}\Omega$)

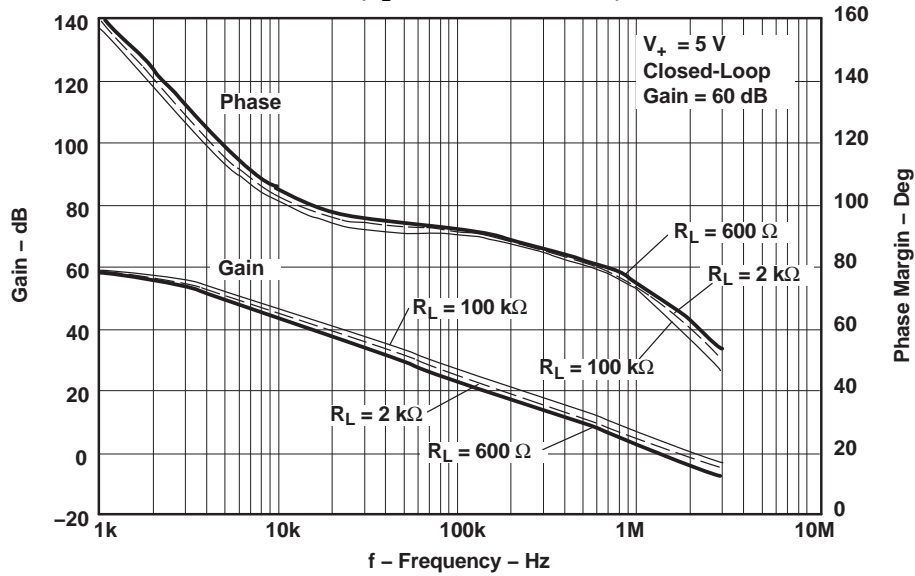

Figure 24.

GAIN AND PHASE MARGIN

vs

FREQUENCY

($C_L = 0 \text{ pF}, 100 \text{ pF}, 500 \text{ pF}, 1000 \text{ pF}$)

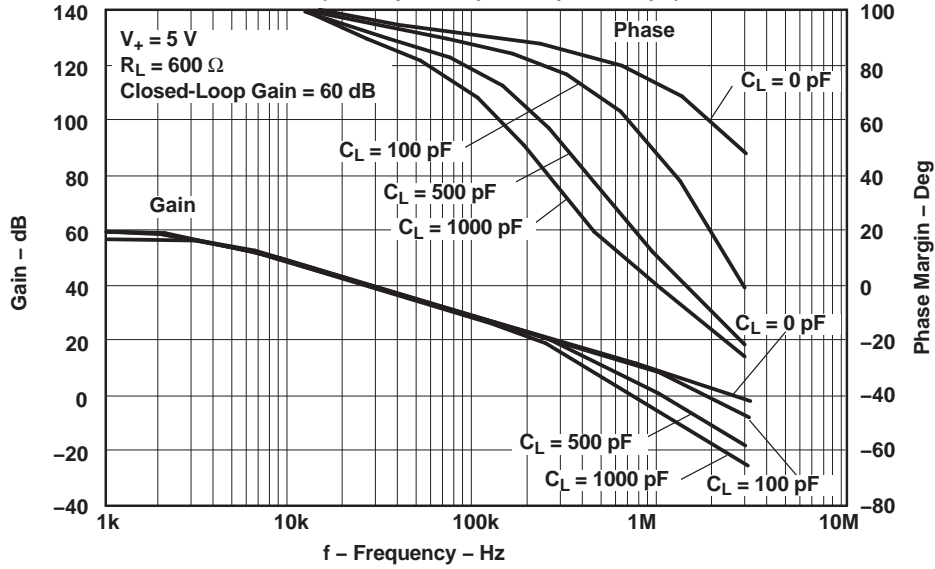

Figure 25.

TYPICAL CHARACTERISTICS (continued)

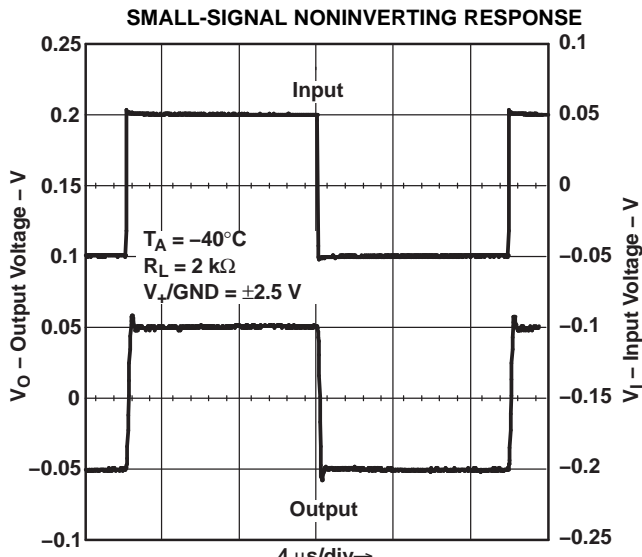

Figure 26.

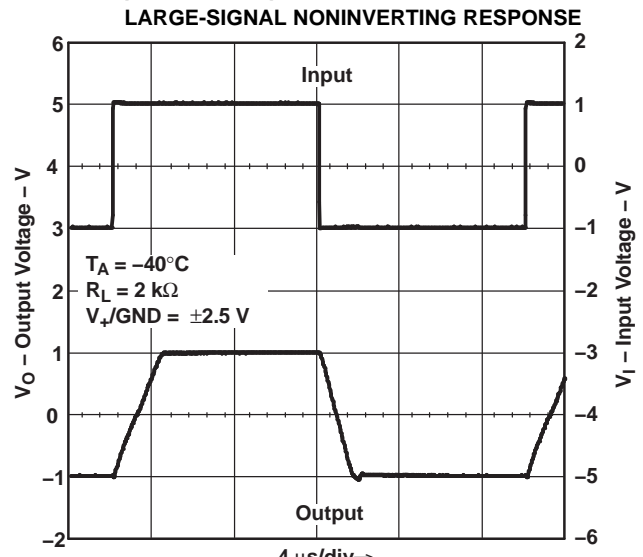

Figure 27.

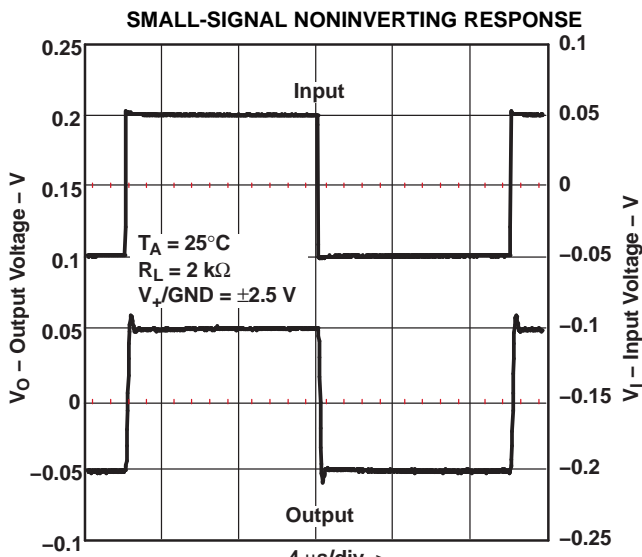

Figure 28.

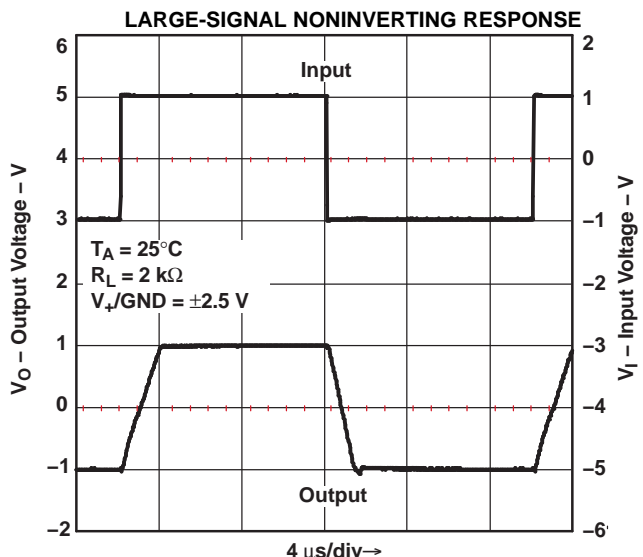

Figure 29.

TYPICAL CHARACTERISTICS (continued)

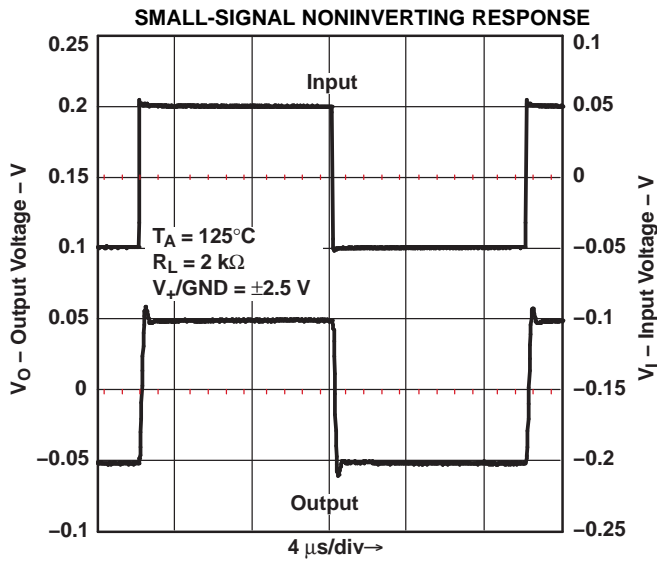

Figure 30.

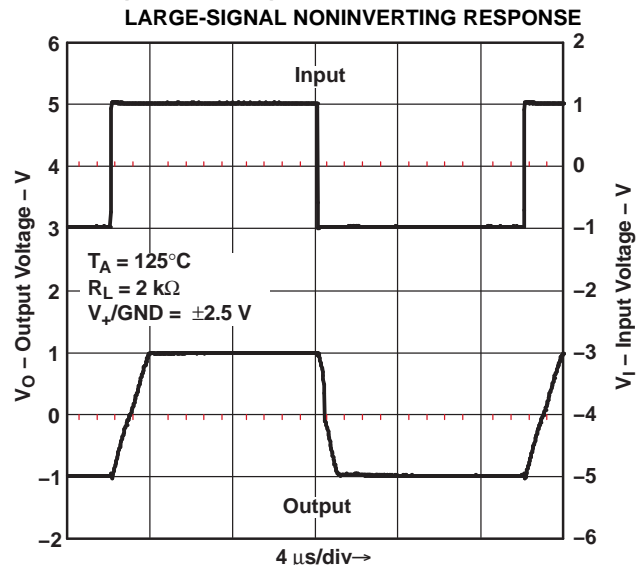

Figure 31.

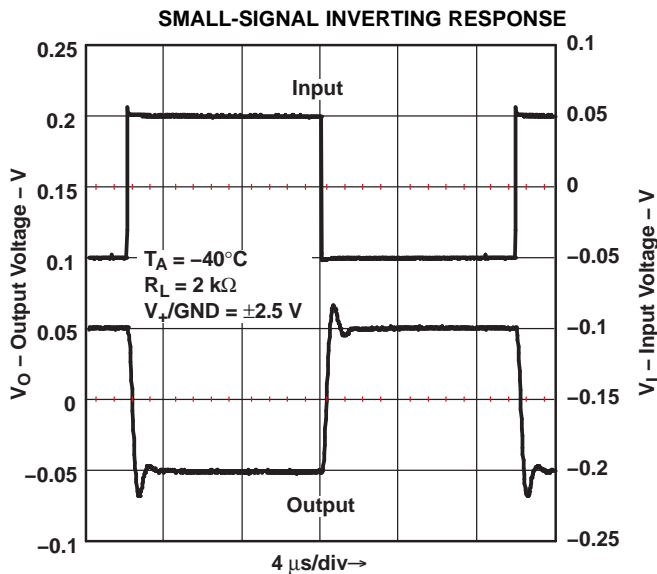

Figure 32.

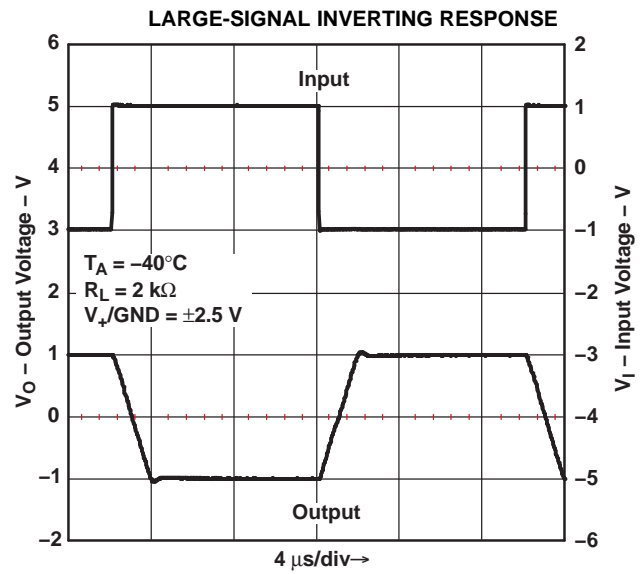
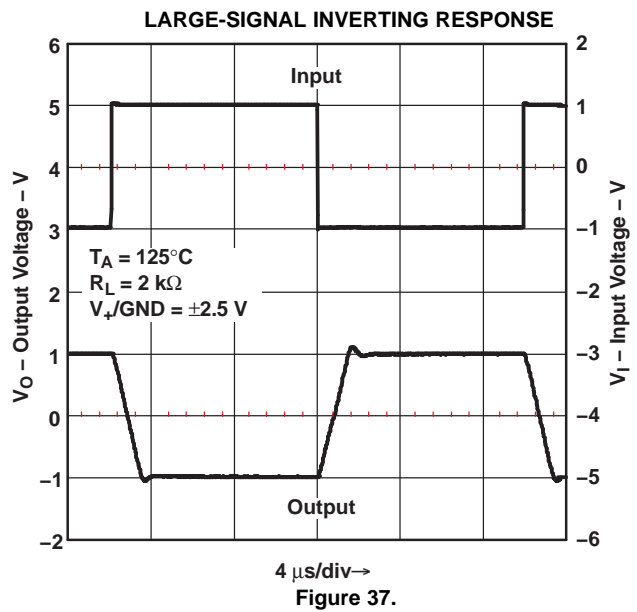
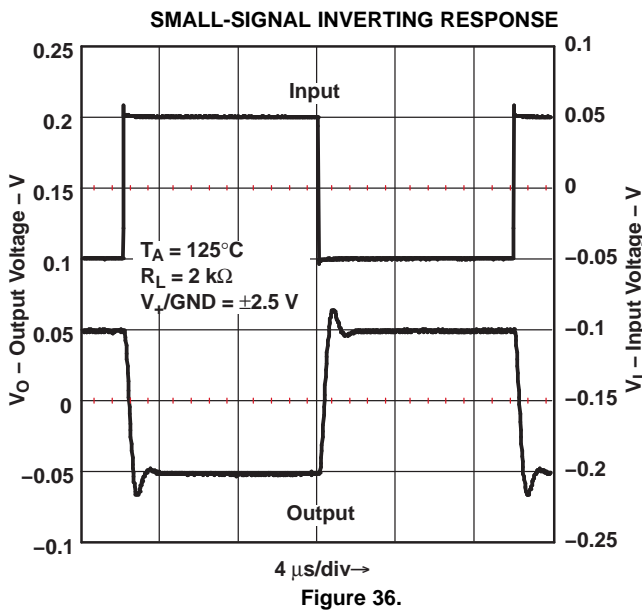
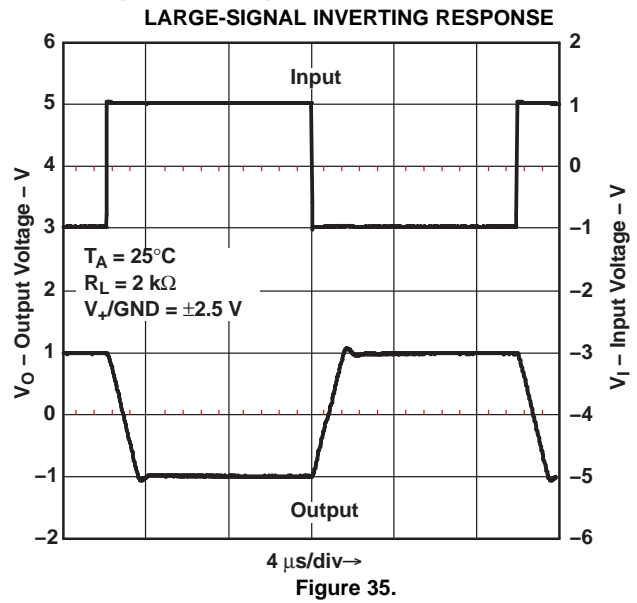
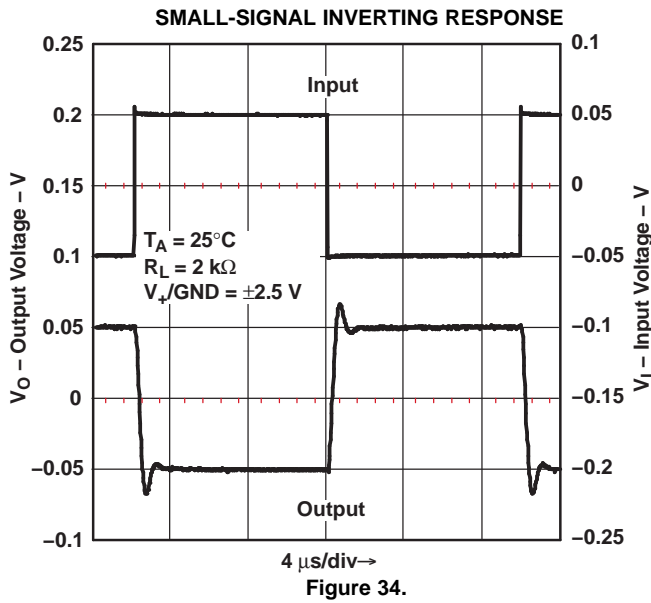

Figure 33.

TYPICAL CHARACTERISTICS (continued)



PACKAGING INFORMATION

Orderable Device	Status (1)	Package Type	Package Drawing	Pins	Package Qty	Eco Plan (2)	Lead/Ball Finish (6)	MSL Peak Temp (3)	Op Temp (°C)	Device Marking (4/5)	Samples
LMV341IDBVR	ACTIVE	SOT-23	DBV	6	3000	Green (RoHS & no Sb/Br)	CU NIPDAU	Level-1-260C-UNLIM	-40 to 125	(RC9A ~ RC9E)	Samples
LMV341IDBVR E4	ACTIVE	SOT-23	DBV	6	3000	Green (RoHS & no Sb/Br)	CU NIPDAU	Level-1-260C-UNLIM	-40 to 125	(RC9A ~ RC9E)	Samples
LMV341IDBVR G4	ACTIVE	SOT-23	DBV	6	3000	Green (RoHS & no Sb/Br)	CU NIPDAU	Level-1-260C-UNLIM	-40 to 125	(RC9A ~ RC9E)	Samples
LMV341IDCKR	ACTIVE	SC70	DCK	6	3000	Green (RoHS & no Sb/Br)	CU NIPDAU	Level-1-260C-UNLIM	-40 to 125	(R4A ~ R4E)	Samples
LMV341IDCKR G4	ACTIVE	SC70	DCK	6	3000	Green (RoHS & no Sb/Br)	CU NIPDAU	Level-1-260C-UNLIM	-40 to 125	(R4A ~ R4E)	Samples
LMV342ID	ACTIVE	SOIC	D	8	75	Green (RoHS & no Sb/Br)	CU NIPDAU	Level-1-260C-UNLIM	-40 to 125	MV342I	Samples
LMV342IDDUR	PREVIEW	VSSOP	DDU	8	3000	TBD	Call TI	Call TI	-40 to 125		
LMV342IDGKR	ACTIVE	VSSOP	DGK	8	2500	Green (RoHS & no Sb/Br)	CU NIPDAU	Level-1-260C-UNLIM	-40 to 125	RPA	Samples
LMV342IDGKR G4	ACTIVE	VSSOP	DGK	8	2500	Green (RoHS & no Sb/Br)	CU NIPDAU	Level-1-260C-UNLIM	-40 to 125	RPA	Samples
LMV342IDGKT	PREVIEW	VSSOP	DGK	8	250	TBD	Call TI	Call TI	-40 to 125		
LMV342IDR	ACTIVE	SOIC	D	8	2500	Green (RoHS & no Sb/Br)	CU NIPDAU	Level-1-260C-UNLIM	-40 to 125	MV342I	Samples
LMV342IDR G4	ACTIVE	SOIC	D	8	2500	Green (RoHS & no Sb/Br)	CU NIPDAU	Level-1-260C-UNLIM	-40 to 125	MV342I	Samples
LMV344ID	ACTIVE	SOIC	D	14	50	Green (RoHS & no Sb/Br)	CU NIPDAU	Level-1-260C-UNLIM	-40 to 125	LMV344I	Samples
LMV344IDG4	ACTIVE	SOIC	D	14	50	Green (RoHS & no Sb/Br)	CU NIPDAU	Level-1-260C-UNLIM	-40 to 125	LMV344I	Samples
LMV344IDR	ACTIVE	SOIC	D	14	2500	Green (RoHS & no Sb/Br)	CU NIPDAU	Level-1-260C-UNLIM	-40 to 125	LMV344I	Samples
LMV344IDRE4	ACTIVE	SOIC	D	14	2500	Green (RoHS & no Sb/Br)	CU NIPDAU	Level-1-260C-UNLIM	-40 to 125	LMV344I	Samples
LMV344IDR G4	ACTIVE	SOIC	D	14	2500	Green (RoHS & no Sb/Br)	CU NIPDAU	Level-1-260C-UNLIM	-40 to 125	LMV344I	Samples
LMV344IPW	ACTIVE	TSSOP	PW	14	90	Green (RoHS & no Sb/Br)	CU NIPDAU	Level-1-260C-UNLIM	-40 to 125	MV344I	Samples

Orderable Device	Status (1)	Package Type	Package Drawing	Pins	Package Qty	Eco Plan (2)	Lead/Ball Finish (6)	MSL Peak Temp (3)	Op Temp (°C)	Device Marking (4/5)	Samples
LMV344IPWG4	ACTIVE	TSSOP	PW	14	90	Green (RoHS & no Sb/Br)	CU NIPDAU	Level-1-260C-UNLIM	-40 to 125	MV344I	Samples
LMV344IPWR	ACTIVE	TSSOP	PW	14	2000	Green (RoHS & no Sb/Br)	CU NIPDAU	Level-1-260C-UNLIM	-40 to 125	MV344I	Samples
LMV344IPWRE4	ACTIVE	TSSOP	PW	14	2000	Green (RoHS & no Sb/Br)	CU NIPDAU	Level-1-260C-UNLIM	-40 to 125	MV344I	Samples
LMV344IPWRG4	ACTIVE	TSSOP	PW	14	2000	Green (RoHS & no Sb/Br)	CU NIPDAU	Level-1-260C-UNLIM	-40 to 125	MV344I	Samples

(1) The marketing status values are defined as follows:

ACTIVE: Product device recommended for new designs.

LIFEBUY: TI has announced that the device will be discontinued, and a lifetime-buy period is in effect.

NRND: Not recommended for new designs. Device is in production to support existing customers, but TI does not recommend using this part in a new design.

PREVIEW: Device has been announced but is not in production. Samples may or may not be available.

OBSOLETE: TI has discontinued the production of the device.

(2) Eco Plan - The planned eco-friendly classification: Pb-Free (RoHS), Pb-Free (RoHS Exempt), or Green (RoHS & no Sb/Br) - please check <http://www.ti.com/productcontent> for the latest availability information and additional product content details.

TBD: The Pb-Free/Green conversion plan has not been defined.

Pb-Free (RoHS): TI's terms "Lead-Free" or "Pb-Free" mean semiconductor products that are compatible with the current RoHS requirements for all 6 substances, including the requirement that lead not exceed 0.1% by weight in homogeneous materials. Where designed to be soldered at high temperatures, TI Pb-Free products are suitable for use in specified lead-free processes.

Pb-Free (RoHS Exempt): This component has a RoHS exemption for either 1) lead-based flip-chip solder bumps used between the die and package, or 2) lead-based die adhesive used between the die and leadframe. The component is otherwise considered Pb-Free (RoHS compatible) as defined above.

Green (RoHS & no Sb/Br): TI defines "Green" to mean Pb-Free (RoHS compatible), and free of Bromine (Br) and Antimony (Sb) based flame retardants (Br or Sb do not exceed 0.1% by weight in homogeneous material)

(3) MSL, Peak Temp. - The Moisture Sensitivity Level rating according to the JEDEC industry standard classifications, and peak solder temperature.

(4) There may be additional marking, which relates to the logo, the lot trace code information, or the environmental category on the device.

(5) Multiple Device Markings will be inside parentheses. Only one Device Marking contained in parentheses and separated by a "~" will appear on a device. If a line is indented then it is a continuation of the previous line and the two combined represent the entire Device Marking for that device.

(6) Lead/Ball Finish - Orderable Devices may have multiple material finish options. Finish options are separated by a vertical ruled line. Lead/Ball Finish values may wrap to two lines if the finish value exceeds the maximum column width.

Important Information and Disclaimer: The information provided on this page represents TI's knowledge and belief as of the date that it is provided. TI bases its knowledge and belief on information provided by third parties, and makes no representation or warranty as to the accuracy of such information. Efforts are underway to better integrate information from third parties. TI has taken and

continues to take reasonable steps to provide representative and accurate information but may not have conducted destructive testing or chemical analysis on incoming materials and chemicals. TI and TI suppliers consider certain information to be proprietary, and thus CAS numbers and other limited information may not be available for release.

In no event shall TI's liability arising out of such information exceed the total purchase price of the TI part(s) at issue in this document sold by TI to Customer on an annual basis.

OTHER QUALIFIED VERSIONS OF LMV341, LMV344 :

- Automotive: [LMV341-Q1](#), [LMV344-Q1](#)

NOTE: Qualified Version Definitions:

- Automotive - Q100 devices qualified for high-reliability automotive applications targeting zero defects

TAPE AND REEL INFORMATION



QUADRANT ASSIGNMENTS FOR PIN 1 ORIENTATION IN TAPE



*All dimensions are nominal

Device	Package Type	Package Drawing	Pins	SPQ	Reel Diameter (mm)	Reel Width W1 (mm)	A0 (mm)	B0 (mm)	K0 (mm)	P1 (mm)	W (mm)	Pin1 Quadrant
LMV341IDBVR	SOT-23	DBV	6	3000	180.0	8.4	3.23	3.17	1.37	4.0	8.0	Q3
LMV341IDCKR	SC70	DCK	6	3000	180.0	8.4	2.41	2.41	1.2	4.0	8.0	Q3
LMV342IDGKR	VSSOP	DGK	8	2500	330.0	12.4	5.3	3.4	1.4	8.0	12.0	Q1
LMV342IDR	SOIC	D	8	2500	330.0	12.4	6.4	5.2	2.1	8.0	12.0	Q1
LMV344IDR	SOIC	D	14	2500	330.0	16.4	6.5	9.0	2.1	8.0	16.0	Q1
LMV344IPWR	TSSOP	PW	14	2000	330.0	12.4	6.9	5.6	1.6	8.0	12.0	Q1

TAPE AND REEL BOX DIMENSIONS



*All dimensions are nominal

Device	Package Type	Package Drawing	Pins	SPQ	Length (mm)	Width (mm)	Height (mm)
LMV341IDBVR	SOT-23	DBV	6	3000	202.0	201.0	28.0
LMV341IDCKR	SC70	DCK	6	3000	202.0	201.0	28.0
LMV342IDGKR	VSSOP	DGK	8	2500	358.0	335.0	35.0
LMV342IDR	SOIC	D	8	2500	340.5	338.1	20.6
LMV344IDR	SOIC	D	14	2500	367.0	367.0	38.0
LMV344IPWR	TSSOP	PW	14	2000	367.0	367.0	35.0

MECHANICAL DATA

DBV (R-PDSO-G6)

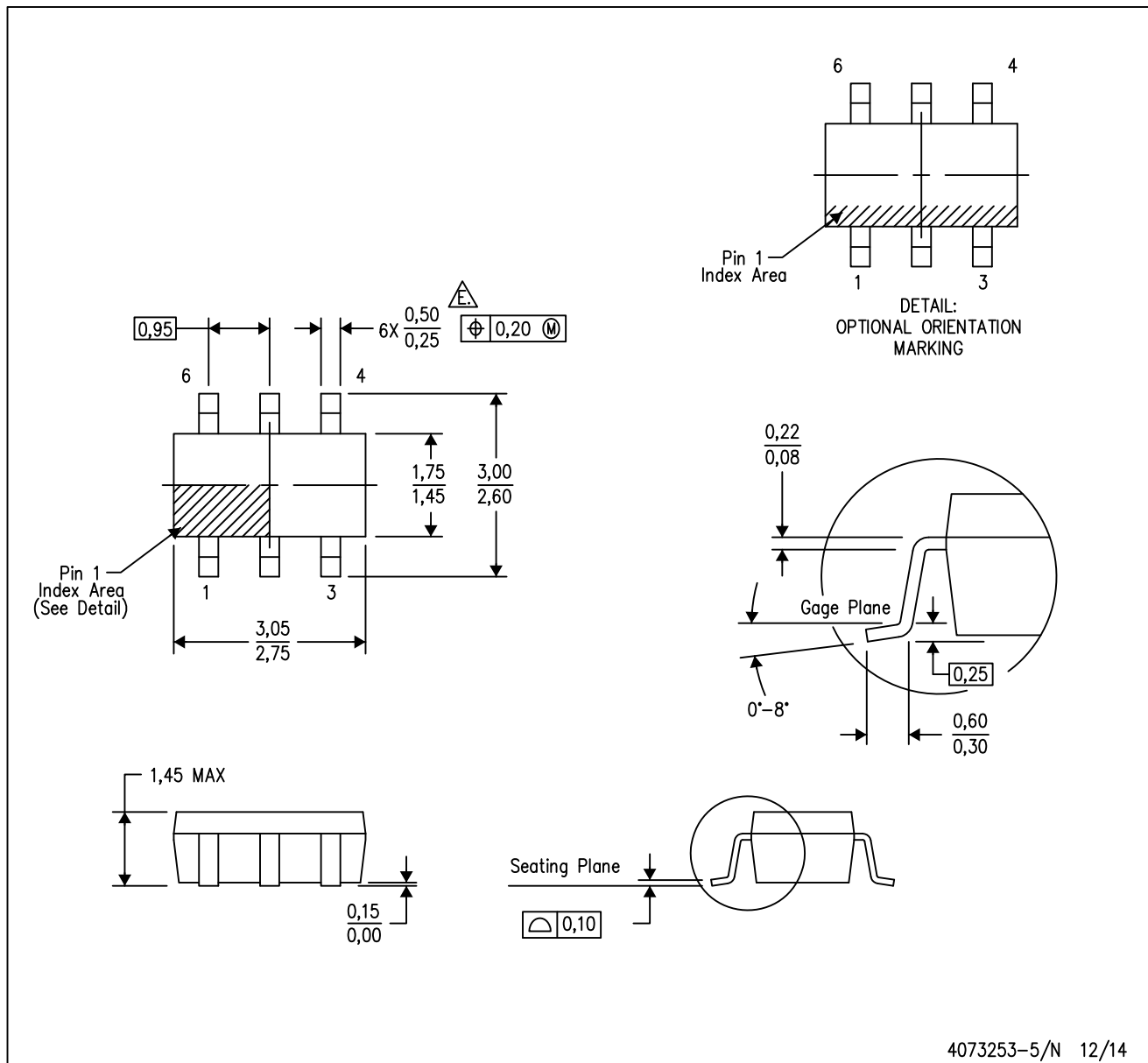
PLASTIC SMALL-OUTLINE PACKAGE



- NOTES:
- A. All linear dimensions are in millimeters.
 - B. This drawing is subject to change without notice.
 - C. Body dimensions do not include mold flash or protrusion. Mold flash and protrusion shall not exceed 0.15 per side.
 - D. Leads 1,2,3 may be wider than leads 4,5,6 for package orientation.
-  Falls within JEDEC MO-178 Variation AB, except minimum lead width.

DBV (R-PDSO-G6)

PLASTIC SMALL OUTLINE



4209593-4/C 08/11

- NOTES:
- A. All linear dimensions are in millimeters.
 - B. This drawing is subject to change without notice.
 - C. Customers should place a note on the circuit board fabrication drawing not to alter the center solder mask defined pad.
 - D. Publication IPC-7351 is recommended for alternate designs.
 - E. Laser cutting apertures with trapezoidal walls and also rounding corners will offer better paste release. Customers should contact their board assembly site for stencil design recommendations. Example stencil design based on a 50% volumetric metal load solder paste. Refer to IPC-7525 for other stencil recommendations.

DCK (R-PDSO-G6)

PLASTIC SMALL-OUTLINE PACKAGE



- NOTES:
- A. All linear dimensions are in millimeters.
 - B. This drawing is subject to change without notice.
 - C. Body dimensions do not include mold flash or protrusion. Mold flash and protrusion shall not exceed 0.15 per side.
 - D. Falls within JEDEC MO-203 variation AB.

DCK (R-PDSO-G6)

PLASTIC SMALL OUTLINE





- NOTES:
- All linear dimensions are in millimeters.
 - This drawing is subject to change without notice.
 - Customers should place a note on the circuit board fabrication drawing not to alter the center solder mask defined pad.
 - Publication IPC-7351 is recommended for alternate designs.
 - Laser cutting apertures with trapezoidal walls and also rounding corners will offer better paste release. Customers should contact their board assembly site for stencil design recommendations. Example stencil design based on a 50% volumetric metal load solder paste. Refer to IPC-7525 for other stencil recommendations.

D (R-PDSO-G14)

PLASTIC SMALL OUTLINE



- NOTES:
- A. All linear dimensions are in inches (millimeters).
 - B. This drawing is subject to change without notice.
 -  Body length does not include mold flash, protrusions, or gate burrs. Mold flash, protrusions, or gate burrs shall not exceed 0.006 (0,15) each side.
 -  Body width does not include interlead flash. Interlead flash shall not exceed 0.017 (0,43) each side.
 - E. Reference JEDEC MS-012 variation AB.

D (R-PDSO-G14)

PLASTIC SMALL OUTLINE



4211283-3/E 08/12

- NOTES:
- All linear dimensions are in millimeters.
 - This drawing is subject to change without notice.
 - Publication IPC-7351 is recommended for alternate designs.
 - Laser cutting apertures with trapezoidal walls and also rounding corners will offer better paste release. Customers should contact their board assembly site for stencil design recommendations. Refer to IPC-7525 for other stencil recommendations.
 - Customers should contact their board fabrication site for solder mask tolerances between and around signal pads.

PW (R-PDSO-G14)

PLASTIC SMALL OUTLINE



- NOTES:
- A. All linear dimensions are in millimeters. Dimensioning and tolerancing per ASME Y14.5M-1994.
 - B. This drawing is subject to change without notice.
 - C. Body length does not include mold flash, protrusions, or gate burrs. Mold flash, protrusions, or gate burrs shall not exceed 0,15 each side.
 - D. Body width does not include interlead flash. Interlead flash shall not exceed 0,25 each side.
 - E. Falls within JEDEC MO-153

PW (R-PDSO-G14)

PLASTIC SMALL OUTLINE



4211284-2/G 08/15

- NOTES:
- All linear dimensions are in millimeters.
 - This drawing is subject to change without notice.
 - Publication IPC-7351 is recommended for alternate designs.
 - Laser cutting apertures with trapezoidal walls and also rounding corners will offer better paste release. Customers should contact their board assembly site for stencil design recommendations. Refer to IPC-7525 for other stencil recommendations.
 - Customers should contact their board fabrication site for solder mask tolerances between and around signal pads.

D (R-PDSO-G8)

PLASTIC SMALL OUTLINE



- NOTES:
- A. All linear dimensions are in inches (millimeters).
 - B. This drawing is subject to change without notice.
 - $\triangle C$ Body length does not include mold flash, protrusions, or gate burrs. Mold flash, protrusions, or gate burrs shall not exceed 0.006 (0,15) each side.
 - $\triangle D$ Body width does not include interlead flash. Interlead flash shall not exceed 0.017 (0,43) each side.
 - E. Reference JEDEC MS-012 variation AA.

D (R-PDSO-G8)

PLASTIC SMALL OUTLINE



- NOTES:
- A. All linear dimensions are in millimeters.
 - B. This drawing is subject to change without notice.
 - C. Publication IPC-7351 is recommended for alternate designs.
 - D. Laser cutting apertures with trapezoidal walls and also rounding corners will offer better paste release. Customers should contact their board assembly site for stencil design recommendations. Refer to IPC-7525 for other stencil recommendations.
 - E. Customers should contact their board fabrication site for solder mask tolerances between and around signal pads.

IMPORTANT NOTICE

Texas Instruments Incorporated and its subsidiaries (TI) reserve the right to make corrections, enhancements, improvements and other changes to its semiconductor products and services per JESD46, latest issue, and to discontinue any product or service per JESD48, latest issue. Buyers should obtain the latest relevant information before placing orders and should verify that such information is current and complete. All semiconductor products (also referred to herein as "components") are sold subject to TI's terms and conditions of sale supplied at the time of order acknowledgment.

TI warrants performance of its components to the specifications applicable at the time of sale, in accordance with the warranty in TI's terms and conditions of sale of semiconductor products. Testing and other quality control techniques are used to the extent TI deems necessary to support this warranty. Except where mandated by applicable law, testing of all parameters of each component is not necessarily performed.

TI assumes no liability for applications assistance or the design of Buyers' products. Buyers are responsible for their products and applications using TI components. To minimize the risks associated with Buyers' products and applications, Buyers should provide adequate design and operating safeguards.

TI does not warrant or represent that any license, either express or implied, is granted under any patent right, copyright, mask work right, or other intellectual property right relating to any combination, machine, or process in which TI components or services are used. Information published by TI regarding third-party products or services does not constitute a license to use such products or services or a warranty or endorsement thereof. Use of such information may require a license from a third party under the patents or other intellectual property of the third party, or a license from TI under the patents or other intellectual property of TI.

Reproduction of significant portions of TI information in TI data books or data sheets is permissible only if reproduction is without alteration and is accompanied by all associated warranties, conditions, limitations, and notices. TI is not responsible or liable for such altered documentation. Information of third parties may be subject to additional restrictions.

Resale of TI components or services with statements different from or beyond the parameters stated by TI for that component or service voids all express and any implied warranties for the associated TI component or service and is an unfair and deceptive business practice. TI is not responsible or liable for any such statements.

Buyer acknowledges and agrees that it is solely responsible for compliance with all legal, regulatory and safety-related requirements concerning its products, and any use of TI components in its applications, notwithstanding any applications-related information or support that may be provided by TI. Buyer represents and agrees that it has all the necessary expertise to create and implement safeguards which anticipate dangerous consequences of failures, monitor failures and their consequences, lessen the likelihood of failures that might cause harm and take appropriate remedial actions. Buyer will fully indemnify TI and its representatives against any damages arising out of the use of any TI components in safety-critical applications.

In some cases, TI components may be promoted specifically to facilitate safety-related applications. With such components, TI's goal is to help enable customers to design and create their own end-product solutions that meet applicable functional safety standards and requirements. Nonetheless, such components are subject to these terms.

No TI components are authorized for use in FDA Class III (or similar life-critical medical equipment) unless authorized officers of the parties have executed a special agreement specifically governing such use.

Only those TI components which TI has specifically designated as military grade or "enhanced plastic" are designed and intended for use in military/aerospace applications or environments. Buyer acknowledges and agrees that any military or aerospace use of TI components which have **not** been so designated is solely at the Buyer's risk, and that Buyer is solely responsible for compliance with all legal and regulatory requirements in connection with such use.

TI has specifically designated certain components as meeting ISO/TS16949 requirements, mainly for automotive use. In any case of use of non-designated products, TI will not be responsible for any failure to meet ISO/TS16949.

Products

Audio	www.ti.com/audio
Amplifiers	amplifier.ti.com
Data Converters	dataconverter.ti.com
DLP® Products	www.dlp.com
DSP	dsp.ti.com
Clocks and Timers	www.ti.com/clocks
Interface	interface.ti.com
Logic	logic.ti.com
Power Mgmt	power.ti.com
Microcontrollers	microcontroller.ti.com
RFID	www.ti-rfid.com
OMAP Applications Processors	www.ti.com/omap
Wireless Connectivity	www.ti.com/wirelessconnectivity

Applications

Automotive and Transportation	www.ti.com/automotive
Communications and Telecom	www.ti.com/communications
Computers and Peripherals	www.ti.com/computers
Consumer Electronics	www.ti.com/consumer-apps
Energy and Lighting	www.ti.com/energy
Industrial	www.ti.com/industrial
Medical	www.ti.com/medical
Security	www.ti.com/security
Space, Avionics and Defense	www.ti.com/space-avionics-defense
Video and Imaging	www.ti.com/video

TI E2E Community

e2e.ti.com

AMEYA360

Components Supply Platform

Authorized Distribution Brand :



Website :

Welcome to visit www.ameya360.com

Contact Us :

➤ Address :

401 Building No.5, JiuGe Business Center, Lane 2301, Yishan Rd
Minhang District, Shanghai , China

➤ Sales :

Direct +86 (21) 6401-6692

Email amall@ameya360.com

QQ 800077892

Skype [ameyasales1](#) [ameyasales2](#)

➤ Customer Service :

Email service@ameya360.com

➤ Partnership :

Tel +86 (21) 64016692-8333

Email mkt@ameya360.com