

Automotive Wireless Transmitter Controller

Features

- Conforms to the latest version WPC “Qi” specification
- Supports wide DC input voltage range of 6 V (limited duration at Start/Stop operation) to 16 V for automotive battery input
- Supports Foreign Object Detection (FOD)
- Low-power system standby available using Freescale Touch technology
- Provides free positioning solutions by using WPC A or B type multi-coil technology
- Uses rail voltage control or phase shift control with fixed operating frequency to control power transfer to help alleviate automotive system interference
- Supports the key FOB avoidance function
- Supports the operation frequency dithering technology to eliminate the AM band interference
- Improved EMC performance for automotive certification
- Supports CAN/LIN/IIC/SCI/SPI interfaces
- LED for system status indication
- Over-voltage/current/temperature protection
- Software based solution to provide maximum design freedom and product differentiation
- AEC-Q100 grade 2 certification
- Dual-mode capable

Applications

- Automotive Wireless Power Transmitter
 - WPC compliant

Overview Description

The WCT100xA is a wireless power transmitter controller that integrates all required functions for WPC “Qi” compliant wireless power transmitter design. The WCT100xA transmitter IC manages the power transfer by receiving commands from the receiver. Receivers are detected by using either standard protocol methods or Freescale touch sensor technology. Once the mobile device is detected, the WCT100xA controls the power transfer by adjusting rail voltage or phase shift of power stage according to message packets sent by mobile device.

To maximize the design freedom and product differentiation, the WCT100xA supports any 5W coil topology capable of supporting WPC Qi-based implementation. In addition, the system supports both WPC and PMA protocols.

The WCT100xA also includes CAN/LIN/IIC/SCI/SPI interfaces, over-voltage/current/temperature protection and FOD method to protect from overheating by misplaced metallic foreign objects. It also handles any system fault and operation status, and provides comprehensive indicator outputs for robust system design.

Wireless Charging System Functional Diagram

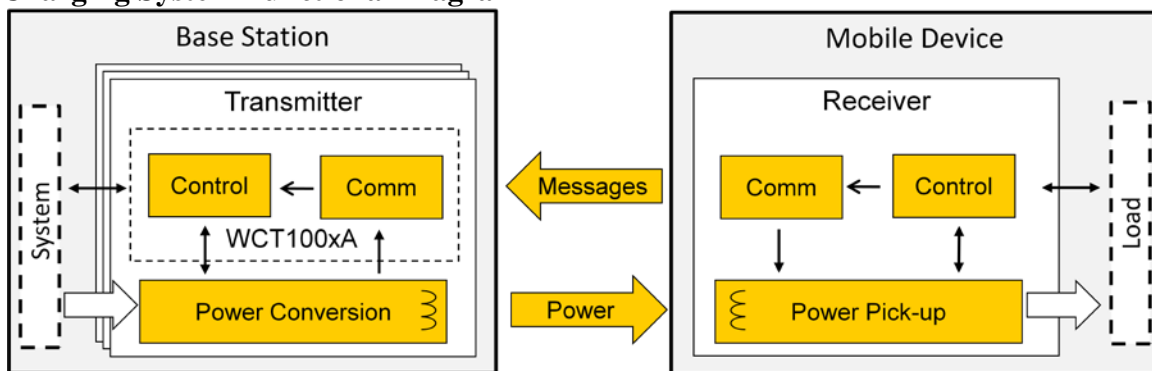

Contents

1	Absolute Maximum Ratings	4
1.1	Electrical Operating Ratings	4
1.2	Thermal Handling Ratings	5
1.3	ESD Handling Ratings	5
1.4	Moisture Handling Ratings	5
2	Electrical Characteristics	5
2.1	General Characteristics	5
2.2	Device Characteristics	8
2.3	Thermal Operating Characteristics	21
3	Typical Performance Characteristics	21
3.1	System Efficiency	21
3.2	Standby Power	22
3.3	Digital Demodulation	23
3.4	Foreign Object Detection	23
4	Device Information	23
4.1	Functional Block Diagram	23
4.2	Product Features Overview	24
4.3	Pinout Diagram	25
4.4	Pin Function Description	25
4.5	Ordering Information	35



4.6	Package Outline Drawing	36
5	Software Library	36
5.1	Memory Map	36
5.2	Software Library and API Description.....	36
6	Design Considerations	36
6.1	Electrical Design Considerations.....	36
6.2	PCB Layout Considerations.....	38
6.3	Thermal Design Considerations.....	38
7	References and Links	38
7.1	References	38
7.2	Useful Links.....	39

1 Absolute Maximum Ratings

1.1 Electrical Operating Ratings

Table 1. Absolute Maximum Electrical Ratings ($V_{SS} = 0\text{ V}$, $V_{SSA} = 0\text{ V}$)

Characteristic	Symbol	Notes ¹	Min.	Max.	Unit
Supply Voltage Range	V_{DD}		-0.3	4.0	V
Analog Supply Voltage Range	V_{DDA}		-0.3	4.0	V
ADC High Voltage Reference	V_{REFHx}		-0.3	4.0	V
Voltage difference V_{DD} to V_{DDA}	ΔV_{DD}		-0.3	0.3	V
Voltage difference V_{SS} to V_{SSA}	ΔV_{SS}		-0.3	0.3	V
Digital Input Voltage Range	V_{IN}	Pin Group 1	-0.3	5.5	V
$\overline{\text{RESET}}$ Input Voltage Range	V_{IN_RESET}	Pin Group 2	-0.3	4.0	V
Oscillator Input Voltage Range	V_{OSC}	Pin Group 4	-0.4	4.0	V
Analog Input Voltage Range	V_{INA}	Pin Group 3	-0.3	4.0	V
Input clamp current, per pin ($V_{IN} < V_{SS} - 0.3\text{ V}$) ^{2,3}	V_{IC}		-	-5.0	mA
Output clamp current, per pin ⁴	V_{OC}		-	± 20.0	mA
Contiguous pin DC injection current—regional limit sum of 16 contiguous pins	I_{Icont}		-25	25	mA
Output Voltage Range (normal push-pull mode)	V_{OUT}	Pin Group 1,2	-0.3	4.0	V
Output Voltage Range (open drain mode)	V_{OUTOD}	Pin Group 1	-0.3	5.5	V
$\overline{\text{RESET}}$ Output Voltage Range	V_{OUTOD_RESET}	Pin Group 2	-0.3	4.0	V
DAC Output Voltage Range	V_{OUT_DAC}	Pin Group 5	-0.3	4.0	V
Ambient Temperature	T_A		-40	105	°C
Storage Temperature Range	T_{STG}		-55	150	°C

- Default Mode:
 - Pin Group 1: GPIO, TDI, TDO, TMS, TCK
 - Pin Group 2: $\overline{\text{RESET}}$
 - Pin Group 3: ADC and Comparator Analog Inputs
 - Pin Group 4: XTAL, EXTAL
 - Pin Group 5: DAC analog output
- Continuous clamp current.
- All 5 volt tolerant digital I/O pins are internally clamped to V_{SS} through an ESD protection diode. There is no diode connection to V_{DD} . If V_{IN} greater than V_{DIO_MIN} ($=V_{SS} - 0.3\text{ V}$) is observed, then there is no need to provide current limiting resistors at the pads. If this limit cannot be observed, then a current limiting resistor is required.
- I/O is configured as push-pull mode.

1.2 Thermal Handling Ratings

Table 2. Thermal Handling Ratings

Symbol	Description	Min.	Max.	Unit	Notes
T _{STG}	Storage temperature	-55	150	°C	1
T _{SDR}	Solder temperature, lead-free	–	260	°C	2

1. Determined according to JEDEC Standard JESD22-A103, *High Temperature Storage Life*.
2. Determined according to IPC/JEDEC Standard J-STD-020, *Moisture/Reflow Sensitivity Classification for Nonhermetic Solid State Surface Mount Devices*.

1.3 ESD Handling Ratings

Table 3. ESD Handling Ratings

Characteristic ¹	Min.	Max.	Unit
ESD for Human Body Model (HBM)	-2000	+2000	V
ESD for Machine Model (MM)	-200	+200	V
ESD for Charge Device Model (CDM)	-500	+500	V
Latch-up current at TA= 85°C (I _{LAT})	-100	+100	mA

1. Parameter is achieved by design characterization on a small sample size from typical devices under typical conditions unless otherwise noted.

1.4 Moisture Handling Ratings

Table 4. Moisture Handling Ratings

Symbol	Description	Min.	Max.	Unit	Notes
MSL	Moisture sensitivity level	–	3	–	1

1. Determined according to IPC/JEDEC Standard J-STD-020, *Moisture/Reflow Sensitivity Classification for Nonhermetic Solid State Surface Mount Devices*.

2 Electrical Characteristics

2.1 General Characteristics

Table 5. General Electrical Characteristics

Recommended Operating Conditions (V _{REFLx} = 0 V, V _{SSA} = 0 V, V _{SS} = 0 V)							
Characteristic	Symbol	Notes	Min.	Typ.	Max.	Unit	Test Conditions
Supply Voltage ²	V _{DD} , V _{DDA}		2.7	3.3	3.6	V	-

ADC (Cyclic) Reference Voltage High	V_{REFHA} V_{REFHB}		3.0		V_{DDA}	V	-
ADC (SAR) Reference Voltage High	V_{REFHC}	3	2.0		V_{DDA}	V	
Voltage difference V_{DD} to V_{DDA}	ΔV_{DD}		-0.1	0	0.1	V	-
Voltage difference V_{SS} to V_{SSA}	ΔV_{SS}		-0.1	0	0.1	V	-
Input Voltage High (digital inputs)	V_{IH}	1 (Pin Group 1)	$0.7 \times V_{DD}$		5.5	V	-
\overline{RESET} Voltage High	V_{IH_RESET}	1 (Pin Group 2)	$0.7 \times V_{DD}$	-	V_{DD}	V	-
Input Voltage Low (digital inputs)	V_{IL}	1 (Pin Group 1,2)			$0.35 \times V_{DD}$	V	-
Oscillator Input Voltage High XTAL driven by an external clock source	V_{IHOSC}	1 (Pin Group 4)	2.0		$V_{DD} + 0.3$	V	-
Oscillator Input Voltage Low	V_{ILOSC}	1 (Pin Group 4)	-0.3		0.8	V	-
Output Source Current High (at V_{OH} min.) ^{4,5} <ul style="list-style-type: none"> • Programmed for low drive strength • Programmed for high drive strength 	I_{OH}	1 (Pin Group 1) 1 (Pin Group 1)	- -		-2 -9	mA	-
Output Source Current Low (at V_{OL} max.) ^{4,5} <ul style="list-style-type: none"> • Programmed for low drive strength • Programmed for high drive strength 	I_{OL}	1 (Pin Group 1,2) 1 (Pin Group 1,2)	- -		2 9	mA	-
Output Voltage High	V_{OH}	1 (Pin Group 1)	$V_{DD} - 0.5$	-	-	V	$I_{OH} = I_{OHmax}$
Output Voltage Low	V_{OL}	1 (Pin Group 1,2)	-	-	0.5	V	$I_{OL} = I_{OLmax}$
Digital Input Current High pull-up enabled or disabled	I_{IH}	1 (Pin Group 1) 1 (Pin Group 2)	-	0	+/-2.5	μA	$V_{IN} = 2.4 V$ to 5.5 V $V_{IN} = 2.4 V$ to V_{DD}
Comparator Input Current High	I_{IHC}	1 (Pin Group 3)		0	+/-2	μA	$V_{IN} = V_{DDA}$
Oscillator Input Current High	I_{IHOSC}	1 (Pin Group 4)	-	0	+/-2	μA	$V_{IN} = V_{DDA}$

Internal Pull-Up Resistance	$R_{\text{Pull-Up}}$		20	-	50	k Ω	-
Internal Pull-Down Resistance	$R_{\text{Pull-Down}}$		20	-	50	k Ω	-
Comparator Input Current Low	I_{ILC}	1 (Pin Group 3)	-	0	+/-2	μA	$V_{\text{IN}} = 0\text{V}$
Oscillator Input Current Low	I_{ILOSC}	1 (Pin Group 4)	-	0	+/-2	μA	$V_{\text{IN}} = 0\text{V}$
DAC Output Voltage Range	V_{DAC}	1 (Pin Group 5)	$V_{\text{SSA}} + 0.04$	-	$V_{\text{DDA}} - 0.04$	V	$R_{\text{LD}} = 3\text{ k}\Omega$, $C_{\text{LD}} = 400\text{ pF}$
Output Current ¹ High Impedance State	I_{OZ}	1 (Pin Group 1,2)	-	0	+/-1	μA	-
Schmitt Trigger Input Hysteresis	V_{HYS}	1 (Pin Group 1,2)	$0.06 \times V_{\text{DD}}$	-	-	V	-
Input capacitance	C_{IN}		-	10	-	pF	-
Output capacitance	C_{OUT}		-	10	-	pF	-
GPIO pin interrupt pulse width ⁶	$T_{\text{INT_Pulse}}$	7	1.5	-	-	Bus clock	-
Port rise and fall time (high drive strength). Slew disabled.	$T_{\text{Port_H_DIS}}$	8	5.5	-	15.1	ns	$2.7 \leq V_{\text{DD}} \leq 3.6\text{ V}$
Port rise and fall time (high drive strength). Slew enabled.	$T_{\text{Port_H_EN}}$	8	1.5	-	6.8	ns	$2.7 \leq V_{\text{DD}} \leq 3.6\text{ V}$
Port rise and fall time (low drive strength). Slew disabled.	$T_{\text{Port_L_DIS}}$	9	8.2	-	17.8	ns	$2.7 \leq V_{\text{DD}} \leq 3.6\text{ V}$
Port rise and fall time (low drive strength). Slew enabled.	$T_{\text{Port_L_EN}}$	9	3.2	-	9.2	ns	$2.7 \leq V_{\text{DD}} \leq 3.6\text{ V}$
Device (system and core) clock frequency	f_{SYSCLK}		0	-	100	MHz	-
Bus clock	f_{BUS}	10	-	-	50/100	MHz	-

1. Default Mode
 - o Pin Group 1: GPIO, TDI, TDO, TMS, TCK
 - o Pin Group 2: RESET
 - o Pin Group 3: ADC and Comparator Analog Inputs
 - o Pin Group 4: XTAL, EXTAL
 - o Pin Group 5: DAC analog output
2. ADC (Cyclic) specifications are not guaranteed when VDDA is below 3.0 V.
3. ADC (SAR) is only on WCT1003A device.
4. Total chip source or sink current cannot exceed 75 mA.
5. Contiguous pin DC injection current of regional limit—including sum of negative injection currents or sum of positive injection currents of 16 contiguous pins—is 25 mA.
6. Applies to a pin only when it is configured as GPIO and configured to cause an interrupt by appropriately programming GPIO_n_IPOLR and GPIO_n_IENR.
7. The greater synchronous and asynchronous timing must be met.

8. 75 pF load
9. 15 pF load
10. WCT1001A only supports the maximum bus clock of 50 MHz, and WCT1003A supports 100 MHz maximum bus clock.

2.2 Device Characteristics

Table 6. General Device Characteristics

Power Mode Transition Behavior					
Symbol	Description	Min.	Max.	Unit	Notes
T _{POR}	After a POR event, the amount of delay from when VDD reaches 2.7 V to when the first instruction executes (over the operating temperature range).	199	225	μs	
T _{S2R}	STOP mode to RUN mode	6.79	7.29	μs	1
T _{LPS2LPR}	LPS mode to LPRUN mode	240	551	μs	2
T _{VLPS2VLPR}	VLPS mode to VLPRUN mode	1424	1500	μs	4
T _{W2R}	WAIT mode to RUN mode	0.57	0.62	μs	3
T _{LPW2LPR}	LPWAIT mode to LPRUN mode	237.2	554	μs	2
T _{VLPW2VLPR}	VLPWAIT mode to VLPRUN mode	1413	1500	μs	4
Power Consumption Operating Behaviors					
Mode	Conditions	Max. Frequency	Typical at 3.3 V, 25 °C		Notes
			I_{DD}	I_{DDA}	
RUN1	100 MHz core clock, 50 MHz peripheral clock, regulators are in full regulation, relaxation oscillator on, PLL powered on, continuous MAC instructions with fetches from program Flash, all peripheral modules enabled, TMRs and SCIs using 1× peripheral clock, NanoEdge within eFlexPWM using 2× peripheral clock, ADC/DAC (only one 12-bit DAC and all 6-bit DACs) powered on and clocked, comparator powered on, all ports configured as inputs with input low and no DC loads	100 MHz	35.58 mA/-	9.08 mA/-	5

RUN2	50 MHz/100 MHz ⁵ core and peripheral clock, regulators are in full regulation, relaxation oscillator on, PLL powered on, continuous MAC instructions with fetches from program Flash, all peripheral modules enabled, TMRs and SCIs using 1× peripheral clock, NanoEdge within eFlexPWM using 2× peripheral clock, ADC/DAC (only one 12-bit DAC and all 6-bit DACs) powered on and clocked, comparator powered on, all ports configured as inputs with input low and no DC loads	50 MHz/100 MHz ⁵	25.62 mA/63.7 mA	9.07 mA/16.7 mA	5
WAIT	50 MHz/100 MHz ⁵ core and peripheral clock, regulators are in full regulation, relaxation oscillator on, PLL powered on, core in WAIT state, all peripheral modules enabled, TMRs and SCIs using 1× clock, NanoEdge within eFlexPWM using 2× clock, ADC/DAC (one 12-bit DAC, all 6-bit DACs)/comparator powered off, all ports configured as inputs with input low and no DC loads	50 MHz/100 MHz ⁵	22.0 mA/43.5 mA	7.93 mA/13.58 μA	5
STOP	4 MHz core and peripheral clock, regulators are in full regulation, relaxation oscillator on, PLL powered off, core in STOP state, all peripheral module and core clocks are off, ADC/DAC/Comparator powered off, all ports configured as inputs with input low and no DC loads	4 MHz	5.58 mA/9.19 mA	1.77 μA/13.20 μA	5
LPRUN	200 kHz core and peripheral clock from relaxation oscillator's low speed clock, relaxation oscillator in standby mode, regulators are in standby, PLL disabled, repeat NOP instructions, all peripheral modules enabled, except NanoEdge within eFlexPWM and cyclic ADCs, one 12-bit DAC and all 6-bit DACs enabled, simple loop with running from platform instruction buffer, all ports configured as inputs with input low and no DC loads	2 MHz	2.39 mA/1.86 mA	0.82 mA/3.33 mA	5
LPWAIT	200 kHz core and peripheral clock from relaxation oscillator's low speed clock, relaxation oscillator in standby mode, regulators are in standby, PLL disabled, all peripheral modules enabled, except NanoEdge within eFlexPWM and cyclic ADCs, one 12-bit DAC and all 6-bit DACs enabled, core in WAIT mode, all ports configured as inputs with input low and no DC loads	2 MHz	2.37 mA/1.83 mA	0.81 mA/2.67 mA	5

LPSTOP	200 kHz core and peripheral clock from relaxation oscillator's low speed clock, relaxation oscillator in standby mode, regulators are in standby, PLL disabled, only PITs and COP enabled, other peripheral modules disabled and clocks gated off, core in STOP mode, all ports configured as inputs with input low and no DC loads	2 MHz	0.99 mA/1.07 mA	0.97 uA/13.13 uA	5
VLPRUN	32 kHz core and peripheral clock from a 64 kHz external clock source, oscillator in power down, all relaxation oscillators disabled, large regulator is in standby, small regulator is disabled, PLL disabled, repeat NOP instructions, all peripheral modules, except COP and EWM, disabled and clocks gated off, simple loop running from platform instruction buffer, all ports configured as inputs with input low and no DC loads	200 kHz	0.48 mA/0.57 mA	0.96 uA/13.04 uA	5
VLPWAIT	32 kHz core and peripheral clock from a 64 kHz external clock source, oscillator in power down, all relaxation oscillators disabled, large regulator is in standby, small regulator is disabled, PLL disabled, all peripheral modules, except COP, disabled and clocks gated off, core in WAIT mode, all ports configured as inputs with input low and no DC loads	200 kHz	0.46 mA/0.56 mA	0.95 uA/12.02 uA	5
VLPSTOP	32 kHz core and peripheral clock from a 64 kHz external clock source, oscillator in power down, all relaxation oscillators disabled, large regulator is in standby, small regulator is disabled, PLL disabled, all peripheral modules, except COP, disabled and clocks gated off, core in STOP mode, all ports configured as inputs with input low and no DC loads	200 kHz	0.43 mA/0.56 mA	0.93 uA/10.58 uA	5

Reset and Interrupt Timing

Symbol	Characteristic	Min.	Max.	Unit	Notes
t _{RA}	Minimum $\overline{\text{RESET}}$ Assertion Duration	16	-	ns	6
t _{RDA}	$\overline{\text{RESET}}$ deassertion to First Address Fetch	$865 \times T_{\text{OSC}} + 8 \times T_{\text{SYSCLK}}$	-	ns	7
t _{IF}	Delay from Interrupt Assertion to Fetch of first instruction (exiting STOP mode)	361.3	570.9	ns	

PMC Low-Voltage Detection (LVD) and Power-On Reset (POR) Parameters

Symbol	Characteristic	Min.	Typ.	Max.	Unit
V _{POR_A}	POR Assert Voltage ⁸	-	2.0	-	V

V _{POR_R}	POR Release Voltage ⁹	-	2.7	-	V
V _{LVI_2p7}	LVI_2p7 Threshold Voltage	-	2.73	-	V
V _{LVI_2p2}	LVI_2p2 Threshold Voltage	-	2.23	-	V
JTAG Timing					
Symbol	Description	Min.	Max.	Unit	Notes
f _{OP}	TCK frequency of operation	DC	f _{SYSClk} /8 (16)	MHz	10
t _{PW}	TCK clock pulse width	50	-	ns	
t _{DS}	TMS, TDI data set-up time	5	-	ns	
t _{DH}	TMS, TDI data hold time	5	-	ns	
t _{DV}	TCK low to TDO data valid	-	30	ns	
t _{TS}	TCK low to TDO tri-state	-	30	ns	
Regulator 1.2 V Parameters					
Symbol	Characteristic	Min.	Typ.	Max.	Unit
V _{CAP}	Output Voltage ¹¹	-	1.22	-	V
I _{SS}	Short Circuit Current ¹²	-	600	-	mA
T _{RSC}	Short Circuit Tolerance (V _{CAP} shorted to ground)	-	-	30	Mins
V _{REF}	Reference Voltage (after trim)	-	1.21	-	V
External Clock Timing					
Symbol	Characteristic	Min.	Typ.	Max.	Unit
f _{OSC}	Frequency of operation (external clock driver)	-	-	50	MHz
t _{PW}	Clock pulse width ¹³	8			ns
t _{rise}	External clock input rise time ¹⁴	-	-	1	ns
t _{fall}	External clock input fall time ¹⁵	-	-	1	ns
V _{ih}	Input high voltage overdrive by an external clock	0.85×V _{DD}	-	-	V
V _{il}	Input low voltage overdrive by an external clock	-	-	0.3×V _{DD}	V
Phase-Locked Loop (PLL) Timing					
Symbol	Characteristic	Min.	Typ.	Max.	Unit
f _{Ref_PLL}	PLL input reference frequency ¹⁶	8	8	16	MHz
f _{OP_PLL}	PLL output frequency ¹⁷	200/240	-	400	MHz
t _{Lock_PLL}	PLL lock time ¹⁸	35.5	-	73.2	μs
t _{DC_PLL}	Allowed Duty Cycle of input reference	40	50	60	%

External Crystal or Resonator Specifications					
Symbol	Characteristic	Min.	Typ.	Max.	Unit
f _{XOSC}	Frequency of operation	4	8	16	MHz
Relaxation Oscillator Electrical Specifications					
Symbol	Characteristic	Min.	Typ.	Max.	Unit
f _{ROSC_8M}	8 MHz Output Frequency ²⁰ RUN Mode	7.84	8	8.16	MHz
	• 0 °C to 105 °C	7.76	8	8.24	MHz
	• -40 °C to 105 °C	266.8	402	554.3	kHz
f _{ROSC_8M_Delta}	8 MHz Frequency Variation RUN Mode				
	Due to temperature	-	+/-1.5	+/-2	%
	• 0 °C to 105 °C	-	+/-1.5	+/-3	%
f _{ROSC_200k/32k} ^{19,20}	200 kHz/32 kHz Output Frequency ^{19,21} RUN Mode	194/30.1	200/32	206/33.9	kHz
	• -40 °C to 105 °C				
f _{ROSC_200k/32k_Delta} ^{19,20}	200 kHz/32 kHz Output Frequency Variation ^{19,21} RUN Mode				
	Due to temperature	-	+/-1.5	+/-2	%
	• 0 °C to 85 °C	-	+/-1.5 (2.5)	+/-3 (4)	%
t _{Stab}	Stabilization Time				
	• 8 MHz output ²³	-	0.12	0.4	µs
	• 200 kHz/32 kHz output ^{19,24}	-	10/14.4	-/16.2	µs
t _{DC_ROSC}	Output Duty Cycle	48	50	52	%
Flash Specifications					
Symbol	Description	Min.	Typ.	Max.	Unit
t _{hvp_{gm4}}	Longword Program high-voltage time	-	7.5	18	µs
t _{hversscr}	Sector Erase high-voltage time ²⁵	-	13	113	ms
t _{hversall}	Erase All high-voltage time ^{25,26}	-	52	452	ms
t _{hversblk32k}	Erase Block high-voltage time for 32 KB ^{25,27}	-	52	452	ms
t _{hversblk256k}	Erase Block high-voltage time for 256 KB ^{25,27}	-	104	904	ms
t _{rd1sec1k/2k}	Read 1s Section execution time (flash sector) ²⁸	-	-	60	µs

$t_{rd1blk32k}$	Read 1s Block execution time ²⁷ • 32 KB FlexNVM	-	-	0.5	ms
$t_{rd1blk256k}$	• 256 KB program Flash	-	-	1.7	ms
t_{pgmchk}	Program Check execution time ²⁸	-	-	45	μ s
t_{rdsrc}	Read Resource execution time ²⁸	-	-	30	μ s
t_{pgm4}	Program Longword execution time	-	65	145	μ s
t_{ersscr}	Erase Flash Sector execution time ²⁹	-	14	114	ms
$t_{ersblk32k}$	Erase Flash Block execution time ^{27,29} • 32 KB FlexNVM	-	55	465	ms
$t_{ersblk256k}$	• 256 KB program Flash	-	122	985	ms
$t_{pgmsec512p}$	Program Section execution time ²⁷ • 512 B program Flash	-	2.4	-	ms
$t_{pgmsec512n}$	• 512 B FlexNVM	-	4.7	-	ms
$t_{pgmsec1kp}$	• 1 KB program Flash	-	4.7	-	ms
$t_{pgmsec1kn}$	• 1 KB FlexNVM	-	9.3	-	ms
t_{rd1all}	Read 1s All Blocks execution time	-	-	0.9/1.8 ³⁰	ms
t_{rdonce}	Read Once execution time ²⁸	-	-	25	μ s
$t_{pgmonce}$	Program Once execution time	-	65	-	μ s
t_{ersall}	Erase All Blocks execution time ²⁹	-	70/175 ³⁰	575/1500 ³⁰	ms
t_{vfykey}	Verify Backdoor Access Key execution time ²⁸	-	-	30	μ s
$t_{pgmpart32k}$	Program Partition for EEPROM execution time for 32 KB FlexNVM ²⁷	-	70	-	ms
$t_{setramff}$	Set FlexRAM Function execution time ²⁷ • Control Code 0xFF	-	50	-	μ s
$t_{setram8k}$	• 8 KB EEPROM backup	-	0.3	0.5	ms
$t_{setram32k}$	• 32 KB EEPROM backup	-	0.7	1.0	ms
$t_{eewr8bers}$	Byte-write to erased FlexRAM location execution time ^{27,31}	-	175	260	μ s
$t_{eewr8b8k}$	Byte-write to FlexRAM execution time ²⁷ • 8 KB EEPROM backup	-	340	1700	μ s
$t_{eewr8b16k}$	• 16 KB EEPROM backup	-	385	1800	μ s
$t_{eewr8b32k}$	• 32 KB EEPROM backup	-	475	2000	μ s
$t_{eewr16bers}$	Word-write to erased FlexRAM location execution time ²⁷	-	175	260	μ s
$t_{eewr16b8k}$	Word-write to FlexRAM execution time ²⁷ • 8 KB EEPROM backup	-	340	1700	μ s
$t_{eewr16b16k}$	• 16 KB EEPROM backup	-	385	1800	μ s
$t_{eewr16b32k}$	• 32 KB EEPROM backup	-	475	2000	μ s
$t_{eewr32bers}$	Longword-write to erased FlexRAM location execution time ²⁷	-	360	540	μ s

$t_{\text{eewr32b8k}}$	Longword-write to FlexRAM execution time ²⁷	-	545	1950	μs
$t_{\text{eewr32b16k}}$	• 8 KB EEPROM backup	-	630	2050	μs
$t_{\text{eewr32b32k}}$	• 16 KB EEPROM backup • 32 KB EEPROM backup	-	810	2250	μs
$t_{\text{flashret10k}}$	Data retention after up to 10 K cycles	5	50^{32}	-	years
$t_{\text{flashret1k}}$	Data retention after up to 1 K cycles	20	100^{32}	-	years
n_{flashcyc}	Cycling endurance ³³	10 K	50 K^{32}	-	cycles
t_{eeret100}	Data retention up to 100% of write endurance ²⁷	5	50^{32}	-	years
t_{eeret10}	Data retention up to 10% of write endurance ²⁷	20	100^{32}	-	years
n_{eewr16}	Write endurance ^{27,34} • EEPROM backup to FlexRAM ratio = 16	35 K	175 K	-	writes
n_{eewr128}	• EEPROM backup to FlexRAM ratio = 128	315 K	1.6 M	-	writes
n_{eewr512}	• EEPROM backup to FlexRAM ratio = 512	1.27 M	6.4 M	-	writes
n_{eewr4k}	• EEPROM backup to FlexRAM ratio = 4096	10 M	50 M	-	writes
n_{eewr8k}	• EEPROM backup to FlexRAM ratio = 8192	20 M	100 M	-	writes

12-bit Cyclic ADC Electrical Specifications

Symbol	Characteristic	Min.	Typ.	Max.	Unit
V_{DDA}	Supply voltage ³⁵	3.0	3.3	3.6	V
V_{REFHX}	V_{REFH} supply voltage ³⁶	$V_{\text{DDA}} - 0.6$		V_{DDA}	V
f_{ADCCLK}	ADC conversion clock ³⁷	0.1/0.6	-	10/20	MHz
R_{ADC}	Conversion range ³⁸ • Fully differential ²⁶ • Single-ended/unipolar	$-(V_{\text{REFH}} - V_{\text{REFL}})$ V_{REFL}	- -	$V_{\text{REFH}} - V_{\text{REFL}}$ V_{REFH}	V V
V_{ADCIN}	Input voltage range (per input) ³⁹ • External Reference • Internal Reference	V_{REFL} V_{SSA}	- -	V_{REFH} V_{DDA}	V V
t_{ADC}	Conversion time ⁴⁰	-	8/6	-	t_{ADCCLK}
t_{ADCPU}	ADC power-up time (from <code>adc_pdn</code>)	-	13	-	t_{ADCCLK}

I _{ADCRUN}	ADC RUN current (per ADC block) ²⁶	-	1.8	-	mA
	ADC RUN current (per ADC block) ²⁷	-	1	-	mA
	• at 600 kHz ADC clock, LP mode	-	5.7	-	mA
	• ≤ 8.33 MHz ADC clock, 00 mode	-	10.5	-	mA
	• ≤ 12.5 MHz ADC clock, 01 mode	-	17.7	-	mA
	• ≤ 16.67 MHz ADC clock, 10 mode	-	22.6	-	mA
I _{ADPWRDWN}	ADC power down current (adc_pdn enabled) ⁴¹	-	0.1/0.02	-	μA
I _{VREFH}	V _{REFH} current (in external mode) ⁴²	-	190/0.001	-	μA
INL _{ADC}	Integral non-linearity ⁴³	-	+/- 1.5 (3)	+/- 2.2 (5)	LSB ⁴⁴
DNL _{ADC}	Differential non-linearity ⁴³	-	+/- 0.5 (0.6)	+/- 0.8 (0.9)	LSB ⁴⁴
V _{OFFSET}	Offset ⁴⁵	-	+/- 8	-	mV
		-	+/- 12 (13.7)	-	mV
E _{GAIN}	Gain Error	-	0.996 to 1.004 ²⁶	0.99 to 1.01	-
		-	0.994 to 1.004 ²⁷	-	-
ENOB	Effective number of bits ⁴⁷	-	10.6/9.5	-	bits
I _{INJ}	Input injection current ⁴⁸	-	-	+/-3	mA
C _{ADCI}	Input sampling capacitance ⁴⁹	-	4.8/1.4	-	pF

16-bit SAR ADC Electrical Specifications²⁷

Symbol	Characteristic	Min.	Typ. ⁵⁰	Max.	Unit
V _{DDA}	Supply voltage	2.7	-	3.6	V
Δ V _{DDA}	Supply voltage delta to V _{DD}	- 0.1	0	+ 0.1	V
Δ V _{SSA}	Supply voltage delta to V _{SS}	- 0.1	0	+ 0.1	V
V _{REFH}	ADC reference voltage high	V _{DDA}	V _{DDA}	V _{DDA}	V
V _{REFL}	ADC reference voltage low	V _{SSA}	V _{SSA}	V _{SSA}	V
V _{ADIN}	Input voltage range	V _{SSA}	-	V _{DDA}	V
C _{ADIN}	Input capacitance	-	8	10	pF
		-	4	5	pF
R _{ADIN}	Input resistance	-	2	5	kΩ
f _{ADCK}	ADC conversion clock frequency ⁵¹	2	-	12	MHz
		1	-	18	MHz
C _{rate}	ADC conversion rate without ADC hardware averaging	37.037	-	461.467	ksps
		20.000	-	818.330	ksps

I_{DDA_ADC}	Supply current ⁵²	-	-	1.7	mA
f_{ADACK}	ADC asynchronous clock source				
	• ADLPC = 1, ADHSC = 0	1.2	2.4	3.9	MHz
	• ADLPC = 1, ADHSC = 1	3.0	4.0	7.3	MHz
	• ADLPC = 0, ADHSC = 0	2.4	5.2	6.1	MHz
INL_{AD}	Integral non-linearity ⁵⁴				
	• 16-bit mode	-	+/- 7.0	- 2.7 to +	LSB ⁵³
	• 12-bit mode	-	+/- 1.0	1.9	LSB ⁵³
DNL_{AD}	Differential non-linearity ⁵⁴				
	• 16-bit mode	-	- 1.0 to + 4.0	-	LSB ⁵³
	• 12-bit mode	-	+/- 0.7	-	LSB ⁵³
E_{FS}	Full-scale error ($V_{ADIN} = V_{DDA}$) ⁵⁴				
	• < 12-bit modes	-	- 1.4	- 1.8	LSB ⁵³
E_Q	Quantization error				
	• 16-bit mode	-	- 1 to 0	-	LSB ⁵³
$ENOB$	12-bit mode	-	- 1.4	- 1.8	LSB ⁵³
	Effective number of bits ⁵⁵				
	16-bit single-ended mode				
	• Avg = 32	12.2	13.9	-	bits
• Avg = 4	11.4	13.1	-	bits	
12-bit single-ended mode	• Avg = 32	-	10.8	-	bits
	• Avg = 4	-	10.2	-	bits
S_{TEMP}	Temp sensor slope under -40 °C to 105 °C	-	1.715	-	mV/°C
V_{TEMP25}	Temp sensor voltage ⁵⁶ at 25 °C	-	722	-	mV
12-bit DAC Electrical Specifications					
Symbol	Characteristic	Min.	Typ.	Max.	Unit
t_{SETTLE}	Settling time ⁵⁷ under $R_{LD} = 3\text{ k}\Omega$, $C_{LD} = 400\text{ pF}$	-	1	-	μs
t_{DACPU}	DAC power-up time (from PWRDWN release to valid DACOUT)	-	-	11	μs
INL_{DAC}	Integral non-linearity ⁵⁹	-	+/- 3	+/- 4	LSB ⁵⁸
DNL_{DAC}	Differential non-linearity ⁵⁹	-	+/- 0.8	+/- 0.9	LSB ⁵⁸

MON _{DAC}	Monotonicity (> 6 sigma monotonicity, < 3.4 ppm non-monotonicity)	Guaranteed			-
V _{OFFSET}	Offset error ⁵⁹ (5% to 95% of full range)	-	+/- 25	+/- 43	mV
E _{GAIN}	Gain error ⁵⁹ (5% to 95% of full range)	-	+/- 0.5	+/- 1.5	%
V _{OUT}	Output voltage range	V _{SSA} + 0.04	-	V _{DDA} - 0.04	V
SNR	Signal-to-noise ratio	-	85	-	dB
ENOB	Effective number of bits	-	11	-	bits
Comparator and 6-bit DAC Electrical Specifications					
Symbol	Description	Min.	Typ.	Max.	Unit
V _{DD}	Supply voltage	2.7	-	3.6	V
I _{DDHS}	Supply current, High-speed mode(EN=1, PMODE=1) ⁶⁰	-	300/-	-/200	μA
I _{DDL}	Supply current, Low-speed mode(EN=1, PMODE=0) ⁶⁰	-	36/-	-/20	μA
V _{AIN}	Analog input voltage	V _{SS} - 0.3	-	V _{DD}	V
V _{AIO}	Analog input offset voltage	-	-	20	mV
V _H	Analog comparator hysteresis ⁶¹ <ul style="list-style-type: none"> • CR0[HYSTCTR]=00 • CR0[HYSTCTR]=01 • CR0[HYSTCTR]=10 • CR0[HYSTCTR]=11 	-	5	13	mV
		-	25/10	48	mV
		-	55/20	105	mV
		-	80/30	148	mV
V _{CMPOH}	Output high	V _{DD} - 0.5	-	-	V
V _{CMPOI}	Output low	-	-	0.5	V
t _{DHS}	Propagation delay, high-speed mode(EN=1, PMODE=1) ⁶²	-	-	50	ns
t _{DLS}	Propagation delay, low-speed mode(EN=1, PMODE=0) ⁶²	-	-	200	ns
t _{DInit}	Analog comparator initialization delay ⁶³	-	40	-	μs
I _{DAC6b}	6-bit DAC current adder (enabled)	-	7	-	μA
R _{DAC6b}	6-bit DAC reference inputs	V _{DDA}	-	V _{DD}	V
INL _{DAC6b}	6-bit DAC integral non-linearity	-0.5	-	0.5	LSB ⁶⁴
DNL _{DAC6b}	6-bit DAC differential non-linearity	-0.3	-	0.3	LSB ⁶⁴
PWM Timing Parameters					
Symbol	Characteristic	Min.	Typ.	Max.	Unit
f _{PWM}	PWM clock frequency	-	100	-	MHz

$t_{SPWMNEP}$	NanoEdge Placement (NEP) step size ^{65,66}	-	312	-	ps	
t_{DFLT}	Delay for fault input activating to PWM output deactivated	1	-	-	ns	
t_{PWMPU}	Power-up time ⁶⁷	-	25	-	μs	
Quad Timer Timing						
Symbol	Characteristic	Min.	Max.	Unit	Notes	
P_{IN}	Timer input period	$2T_{timer} + 6$	-	ns	68	
P_{INHL}	Timer input high/low period	$1T_{timer} + 3$	-	ns	68	
P_{OUT}	Timer output period	$2T_{timer} - 2$	-	ns	68	
P_{OUTH}	Timer output high/low period	$1T_{timer} - 2$	-	ns	68	
QSPI Timing⁶⁹						
Symbol	Characteristic	Min.		Max.		Unit
		Master	Slave	Master	Slave	
t_C	Cycle time	60/35	60/35	-	-	ns
t_{ELD}	Enable lead time	-	20/17.5	-	-	ns
t_{ELG}	Enable lag time	-	20/17.5	-	-	ns
t_{CH}	Clock (SCLK) high time	28/16.6	28/16.6	-	-	ns
t_{CL}	Clock (SCLK) low time	28/16.6	28/16.6	-	-	ns
t_{DS}	Data set-up time required for inputs	20/16.5	1	-	-	ns
t_{DH}	Data hold time required for inputs	1	3	-	-	ns
t_A	Access time (time to data active from high-impedance state)		5		-	ns
t_D	Disable time (hold time to high-impedance state)		5		-	ns
t_{DV}	Data valid for outputs	-	-	-/5	-/15	ns
t_{DI}	Data invalid	0	0	-	-	ns
t_R	Rise time	-	-	1	1	ns
t_F	Fall time	-	-	1	1	ns
QSCI Timing						
Symbol	Characteristic	Min.	Max.	Unit	Notes	
BR_{SCI}	Baud rate	-	$(f_{MAX_SCI} / 16)$	Mbit/s	70	
PW_{RXD}	RXD pulse width	$0.965/BR_{SCI}$	$1.04/BR_{SCI}$	ns		
PW_{TXD}	TXD pulse width	$0.965/BR_{SCI}$	$1.04/BR_{SCI}$	ns		
LIN Slave Mode						
$F_{TOL_UNSYNCH}$	Deviation of slave node clock from nominal clock rate before synchronization	- 14	14	%		
F_{TOL_SYNCH}	Deviation of slave node clock relative to the master node clock after synchronization	- 2	2	%		

T _{BREAK}	Minimum break character length	13	-	Mater node bit periods			
		11	-	Slave node bit periods			
CAN Timing							
Symbol	Characteristic	Min.	Max.	Unit	Notes		
BR _{CAN}	Baud rate	-	1	Mbit/s			
T _{WAKEUP}	CAN Wakeup dominant pulse filtered	-	1.5/2	µs	71		
T _{WAKEUP}	CAN Wakeup dominant pulse pass	5	-	µs			
IIC Timing							
Symbol	Characteristic	Min.		Max.		Unit	Notes
		Min.	Max.	Min.	Max.		
f _{SCL}	SCL clock frequency	0	100	0	400	kHz	
t _{HD_STA}	Hold time (repeated) START condition. After this period, the first clock pulse is generated.	4	-	0.6	-	µs	
t _{SCL_LOW}	LOW period of the SCL clock	4.7	-	1.3	-	µs	
t _{SCL_HIGH}	HIGH period of the SCL clock	4	-	0.6	-	µs	
t _{SU_STA}	Set-up time for a repeated START condition	4.7	-	0.6	-	µs	
t _{HD_DAT}	Data hold time for IIC bus devices	0 ⁷²	3.45 ⁷³	0 ⁷⁴	0.9 ⁷²	µs	
t _{SU_DAT}	Data set-up time	250 ⁷⁵	-	100 ⁷⁶	-	ns	73
t _r	Rise time of SDA and SCL signals	-	1000	20 + 0.1C _b	300	ns	77
t _f	Fall time of SDA and SCL signals	-	300	20 + 0.1C _b	300	ns	76
t _{SU_STOP}	Set-up time for STOP condition	4	-	0.6	-	µs	
t _{BUS_Free}	Bus free time between STOP and START condition	4.7	-	1.3	-	µs	
t _{SP}	Pulse width of spikes that must be suppressed by the input filter	N/A	N/A	0	50	ns	

- CPU clock = 4 MHz and System running from 8 MHz IRC Applicable to all wakeup times: Wakeup times (in 1,2,3,4) are measured from GPIO toggle for wakeup till GPIO toggle at the wakeup interrupt subroutine from respective stop/wait mode.
- CPU clock = 200 kHz and 8 MHz IRC on standby. Exit via interrupt on Port C GPIO.
- Clock configuration: CPU and system clocks= 100 MHz; Bus Clock = 50 MHz. Exit via an interrupt on PortC GPIO.
- Using 64 KHz external clock; CPU Clock = 32 KHz. Exit via an interrupt on PortC GPIO.
- WCT1001A supports maximum 100 MHz CPU clock and 50 MHz peripheral bus clock, maximum 100 MHz CPU and peripheral bus clock for WCT1003A. In total, WCT1003A has higher power consumption than WCT1001A in the same operating mode. For the current consumption data, the former is for WCT1001A, and the latter for WCT1003A.
- If the $\overline{\text{RESET}}$ pin filter is enabled by setting the RST_FLT bit in the SIM_CTRL register to 1, the minimum pulse assertion must be greater than 21 ns.
- TOSC means oscillator clock cycle; TSYCLK means system clock cycle.
- During 3.3 V VDD power supply ramp down.
- During 3.3 V VDD power supply ramp up (gated by LVI_2p7).
- The maximum TCK operation frequency is f_{SYCLK}/8 for WCT1001A, f_{SYCLK}/16 for WCT1003A.
- Value is after trim.

12. Guaranteed by design.
13. The chip may not function if the high or low pulse width is smaller than 6.25 ns.
14. External clock input rise time is measured from 10% to 90%.
15. External clock input fall time is measured from 90% to 10%.
16. An externally supplied reference clock should be as free as possible from any phase jitter for the PLL to work correctly. The PLL is optimized for 8 MHz input.
17. The frequency of the core system clock cannot exceed 100 MHz. If the NanoEdge PWM is available, the PLL output must be set to 400 MHz. And the minimum PLL output frequency is 200 MHz for WCT1001A, 240 MHz for WCT1003A.
18. This is the time required after the PLL is enabled to ensure reliable operation.
19. 200 kHz internal RC oscillator is on WCT1001A, 32 kHz internal RC oscillator on WCT1003A.
20. Frequency after application of 8 MHz trimmed.
21. Frequency after application of 200 kHz/32 kHz trimmed.
22. Typical +/-1.5%, maximum +/-3% frequency variation for 200 kHz internal RC oscillator, and typical +/-2.5%, maximum +/-4% frequency variation for 32 kHz internal RC oscillator.
23. Standby to run mode transition.
24. Power down to run mode transition. Typical 10 μ s stabilization time for 200 kHz internal RC oscillator, and 14.4 μ s stabilization time for 32 kHz internal RC oscillator.
25. Maximum time based on expectations at cycling end-of-life.
26. The specification is only for WCT1001A.
27. The specification is only for WCT1003A.
28. Assumes 25 MHz flash clock frequency.
29. Maximum times for erase parameters based on expectations at cycling end-of-life.
30. All blocks size is 64 KB on WCT1001A, 256 KB on WCT1003A. Longer all blocks command operation time for WCT1003A.
31. For byte-writes to an erased FlexRAM location, the aligned word containing the byte must be erased.
32. Typical data retention values are based on measured response accelerated at high temperature and derated to a constant 25°C use profile. Engineering Bulletin EB618 does not apply to this technology. Typical endurance defined in Engineering Bulletin EB619.
33. Cycling endurance represents number of program/erase cycles at $-40^{\circ}\text{C} \leq T_j \leq 125^{\circ}\text{C}$.
34. Write endurance represents the number of writes to each FlexRAM location at $-40^{\circ}\text{C} \leq T_j \leq 125^{\circ}\text{C}$ influenced by the cycling endurance of the FlexNVM and the allocated EEPROM backup. Minimum and typical values assume all byte-writes to FlexRAM.
35. The ADC functions up to $V_{DDA} = 2.7$ V. When V_{DDA} is below 3.0 V, ADC specifications are not guaranteed.
36. When the input is at the V_{REFL} level, the resulting output will be all zeros (hex 000), plus any error contribution due to offset and gain error. When the input is at the V_{REFH} level the output will be all ones (hex FFF), minus any error contribution due to offset and gain error.
37. ADC clock duty cycle is 45% ~ 55%. WCT1001A only supports the maximum ADC clock of 10 MHz and minimum ADC clock of 0.1 MHz, and WCT1003A supports 20 MHz maximum ADC clock and 0.6 MHz minimum ADC clock.
38. Conversion range is defined for x1 gain setting. For x2 and x4 the range is 1/2 and 1/4, respectively.
39. In unipolar mode, positive input must be ensured to be always greater than negative input.
40. For WCT1001A, the first conversion takes 10 clock cycles, 8 clock cycles for the subsequent conversion; On WCT1003A, 8.5 clock cycles for the first conversion, 6 clock cycles for the subsequent conversion.
41. For WCT1001A, the power down current of ADC is 0.1 μ A, and 0.02 μ A for WCT1003A.
42. For WCT1001A, the V_{REFH} current of ADC is 190 μ A, and 0.001 μ A for WCT1003A.
43. INL_{ADC}/DNL_{ADC} is measured from $V_{ADCIN} = V_{REFL}$ to $V_{ADCIN} = V_{REFH}$ using Histogram method at x1 gain setting. On WCT1001A, typical value is +/- 1.5 LSB, and maximum value +/- 2.2 LSB for INL_{ADC} ; typical value is +/- 0.5 LSB, and maximum value +/- 0.8 LSB for DNL_{ADC} . On WCT1003A, typical value is +/- 3 LSB, and maximum value +/- 5 LSB for INL_{ADC} ; typical value is +/- 0.6 LSB, and maximum value +/- 1 LSB for DNL_{ADC} .
44. Least Significant Bit = 0.806 mV at 3.3 V V_{DDA} , x1 gain setting.
45. Any off-channel with 50 kHz full-scale input to the channel being sampled with DC input (isolation crosstalk).
46. Typical +/- 12 mV offset for WCT1001A, +/- 13.7 mV offset for WCT1003A.
47. Typical ENOB is 10.6 bits for WCT1001A, 9.5 bits for WCT1003A.
48. The current that can be injected into or sourced from an unselected ADC input without affecting the performance of the ADC.
49. Typical input capacitance is 4.8 pF for WCT1001A, 1.4 pF for WCT1003A.
50. Typical values assume $V_{DDA} = 3.0$ V, Temp = 25 $^{\circ}\text{C}$, $f_{ADCK} = 1.0$ MHz unless otherwise stated. Typical values are for reference only and are not tested in production.
51. To use the maximum ADC conversion clock frequency, the ADHSC bit must be set and the ADLPC bit must be clear.
52. The ADC supply current depends on the ADC conversion clock speed, conversion rate and the ADLPC bit (low power). For lowest power operation the ADLPC bit should be set, the HSC bit should be clear with 1MHz ADC conversion clock speed.

53. $1 \text{ LSB} = (\text{VREFH} - \text{VREFL})/2^N$.
54. ADC conversion clock < 16 MHz, Max hardware averaging (AVGE = %1, AVGS = %11).
55. Input data is 100 Hz sine wave; ADC conversion clock < 12 MHz.
56. System clock = 4 MHz, ADC clock = 2 MHz, AVG = Max, Long Sampling = Max.
57. Settling time is swing range from VSSA to VDDA.
58. $\text{LSB} = 0.806 \text{ mV}$.
59. No guaranteed specification within 5% of VDDA or VSSA.
60. Typical supply current with high-speed mode is 300 μA , typical supply current with low-speed mode is 36 μA on WCT1001A. Maximum supply current with high-speed mode is 200 μA , maximum supply current with low-speed mode is 20 μA on WCT1003A.
61. Typical hysteresis is measured with input voltage range limited to 0.7 to VDD-0.7 V. On WCT1001A, typical 25 mV for CR0[HYSTCTR] = 01, typical 55 mV for CR0[HYSTCTR] = 10, typical 80 mV for CR0[HYSTCTR] = 11. On WCT1003A, typical 10 mV for CR0[HYSTCTR] = 01, typical 20 mV for CR0[HYSTCTR] = 10, typical 30 mV for CR0[HYSTCTR] = 11.
62. Signal swing is 100 mV.
63. Comparator initialization delay is defined as the time between software writes to change control inputs (Writes to DACEN, VRSEL, PSEL, MSEL, VOSEL) and the comparator output settling to a stable level.
64. $1 \text{ LSB} = \text{Vreference}/64$.
65. Reference IPbus clock of 100 MHz in NanoEdge Placement mode.
66. Temperature and voltage variations do not affect NanoEdge Placement step size.
67. Powerdown to NanoEdge mode transition.
68. $T_{\text{timer}} = \text{Timer input clock cycle}$. For 100 MHz operation, $T_{\text{timer}} = 10 \text{ ns}$.
69. For QSPI specifications, all data with xx/xx format, the former is for WCT1001A, the latter is for WCT1003A.
70. fMAX_SCI is the frequency of operation of the SCI clock in MHz, which can be selected as the bus clock or 2x bus clock for the device.
71. WCT1001A supports maximum 1.5 μs pulse filtered, and WCT1003A supports maximum 2 μs pulse filtered.
72. The master mode IIC deasserts ACK of an address byte simultaneously with the falling edge of SCL. If no slaves acknowledge this address byte, then a negative hold time can result, depending on the edge rates of the SDA and SCL lines.
73. The maximum tHD_DAT must be met only if the device does not stretch the LOW period (tSCL_LOW) of the SCL signal.
74. Input signal Slew = 10 ns and Output Load = 50 pF
75. Set-up time in slave-transmitter mode is 1 IPBus clock period, if the TX FIFO is empty.
76. A Fast mode IIC bus device can be used in a Standard mode IIC bus system, but the requirement $t_{\text{SU_DAT}} \geq 250 \text{ ns}$ must then be met. This is automatically the case if the device does not stretch the LOW period of the SCL signal. If such a device does stretch the LOW period of the SCL signal, then it must output the next data bit to the SDA line $t_{\text{max}} + t_{\text{SU_DAT}} = 1000 + 250 = 1250 \text{ ns}$ (according to the Standard mode IIC bus specification) before the SCL line is released.
77. C_b = total capacitance of the one bus line in pF.

2.3 Thermal Operating Characteristics

Table 7. General Thermal Characteristics

Symbol	Description	Min	Max	Unit
T_J	Die junction temperature	-40	125	$^{\circ}\text{C}$
T_A	Ambient temperature	-40	105	$^{\circ}\text{C}$

3 Typical Performance Characteristics

3.1 System Efficiency

The typical maximum system efficiency (receiver output power vs. transmitter input power) on Freescale WCT100xA A13 transmitter reference solution is shown in Figure 1, using a test receiver (aka Rx, low power receiver) under resistive load.

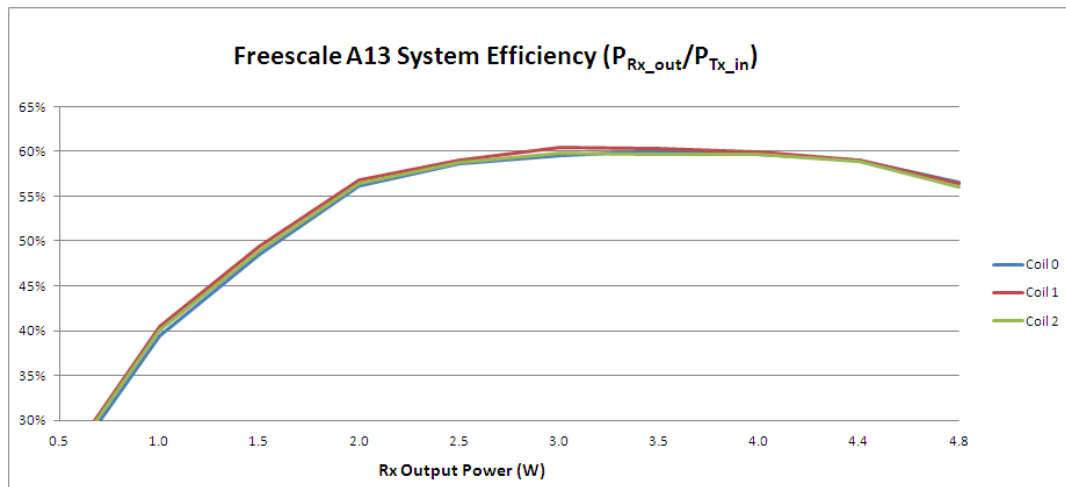

Figure 1. System Efficiency on Freescale A13 Reference Board

Note: Power components are the main factor to determine the system efficiency, such as drivers and MOSFETs.

Figure 2 shows the active charging area of the Freescale WCT100xA A13 transmitter reference solution — transmitter well charges receiver load at different X/Y offsets. For this test, the low power receiver is used as the test receiver with constant 700 mA loading and 3 mm Z gap between transmitter surface and receiver surface.

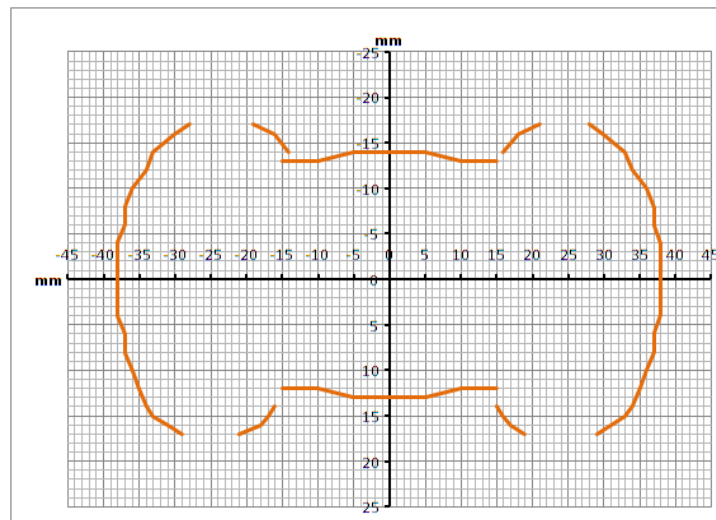

Figure 2. Active Charging Area on WCT100xA A13 Transmitter Reference Solution

3.2 Standby Power

The purpose of the standby mode of operation is to reduce the power consumption of a wireless power transfer system when power transfer is not required. There are two ways to enter standby mode. The first is when the transmitter does not detect the presence of a valid receiver. The second is when the receiver sends only an End Power Transfer Packet. In standby mode, the transmitter only monitors whether a receiver is placed on the active charging area of the transmitter or removed from there.

It is recommended that the transmitter's power consumption in standby mode meets the relative regional regulations especially for "No-load power consumption".

3.3 Digital Demodulation

In order to optimize system BOM cost, WCT100xA solution employs digital demodulation algorithm to communicate with receiver. This method can achieve high performance, low cost, and very simple coil signal sensing circuit with fewer external components.

3.4 Foreign Object Detection

WCT100xA solution employs flexible, intelligent, and easy-to-use FOD algorithm to ensure accurate foreign metal objects detection. With Freescale FreeMASTER GUI tool, FOD algorithm can be easily calibrated to get accurate power loss information especially for very sensitive foreign objects.

4 Device Information

4.1 Functional Block Diagram

This functional block diagram just shows the common pin assignment information by all members of the family. For the detailed pin multiplexing information, refer to Section 4.4 "Pin Function Description".

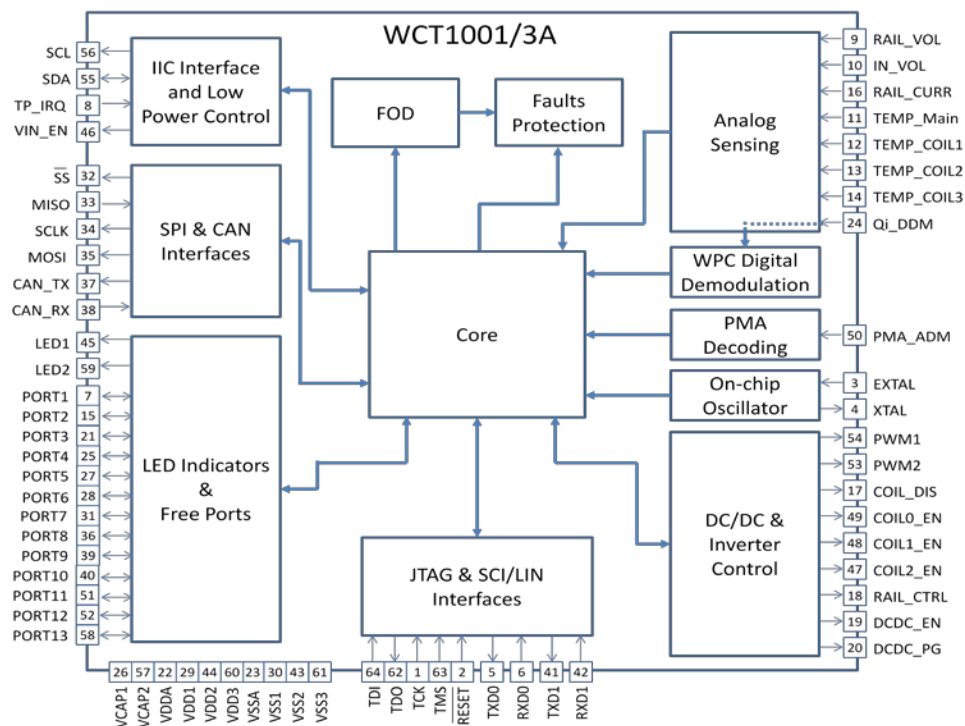

Figure 3. WCT1001/3AVLH Function Block Diagram

4.2 Product Features Overview

The following table highlights features that differ among members of the family. Features not listed are shared in common by all members of the family.

Table 8. Feature Comparison Between WCT1001A and WCT1003A

Part		WCT1001A	WCT1003A
Maximum Core/Bus Clock (MHz)		100/50	100/100
Maximum Fully Run Current Consumption (mA)		35.58 (V _{DD}) + 9.08 (V _{DDA})	63.7 (V _{DD}) + 16.7 (V _{DDA})
On-Chip Flash Memory Size (KB)	Program Flash Memory	64	256
	FlexNVM/FlexRAM	0/0	32/2
	Total Flash Memory	64	288
On-Chip SRAM Memory Size (KB)		8	32
Memory Resource Protection		Yes	Yes
Inter-Peripheral Crossbar Switches with AOI		Yes	Yes
On-Chip Relaxation Oscillator		1 (8 MHz) + 1 (200 kHz)	1 (8 MHz) + 1 (32 kHz)
Computer Operating Properly (Watchdog)		1 (windowed)	1
External Watchdog Monitor		1	1
Cyclic Redundancy Check		1	1
Periodic Interrupt Timer		2	2
Quad Timer		1 x 4	2 x 4
Programmable Delay Block		0	2
12-bit Cyclic ADC Channels		2 x 8	2 x 8
16-bit SAR ADC Channels		0	1 x 8
PWM Channels	High-Resolution	8	8
	Standard	4	1
12-bit DAC		2	1
Analog Comparator /w 6-bit REF DAC		4	4
DMA Channels		4	4
Queued Serial Communications Interface		2	2
Queued Serial Peripheral Interface		2	1
Inter-Integrated Circuit		1	2
Controller Area Network		1 (MSCAN)	1 (FlexCAN)
GPIO		54	54
Package		64 LQFP	64 LQFP

4.3 Pinout Diagram

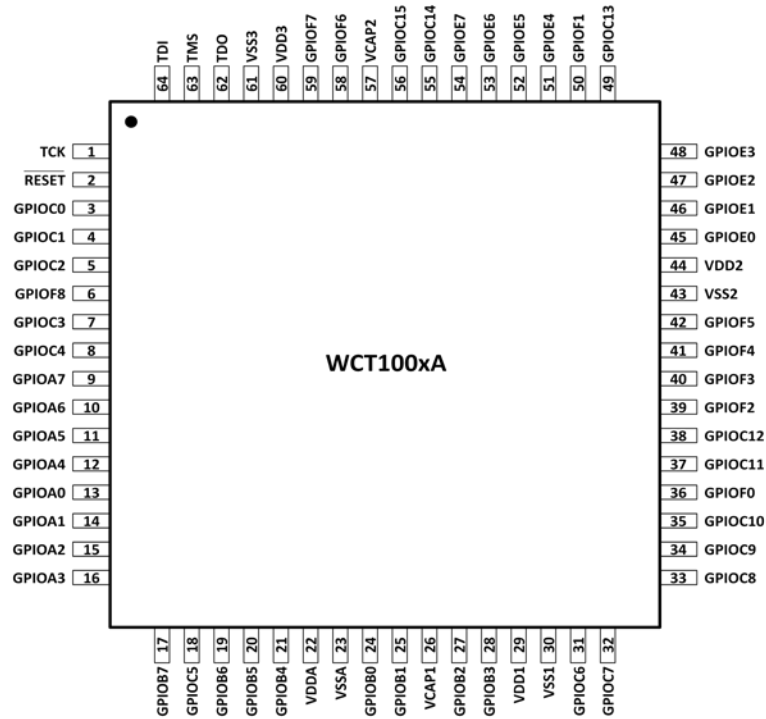

Figure 4. WCT1001/3AVLH Pinout Diagram

4.4 Pin Function Description

By default, each pin is configured for its primary function (listed first). Any alternative functionality, shown in parentheses, can be programmed through GPIO module peripheral enable registers and SIM module GPIO peripheral select registers.

Table 9. Pin Signal Descriptions

Signal Name	Pin No.	Multiplexing Signals	Function Description
TCK	1	GPIOD2	<p>Test Clock Input — This input pin provides a gated clock to synchronize the test logic and shift serial data to the JTAG/EOnCE port. The pin is connected internally to a pull-up resistor. A Schmitt-trigger input is used for noise immunity.</p> <p>Port D GPIO — This GPIO pin can be individually programmed as an input or output pin.</p> <p>After reset, the default state is TCK.</p>
$\overline{\text{RESET}}$	2	GPIOD4	<p>$\overline{\text{RESET}}$ — This input is a direct hardware reset on the processor. When $\overline{\text{RESET}}$ is asserted low, the device is initialized and placed in the reset state. A Schmitt-trigger input is used for noise immunity. The internal reset signal is de-asserted synchronous with the internal clocks after a fixed number of internal clocks.</p>

			<p>Port D GPIO — This GPIO pin can be individually programmed as an input or output pin. If $\overline{\text{RESET}}$ functionality is disabled in this mode and the chip can be reset only via POR, COP reset, or software reset.</p> <p>After reset, the default state is $\overline{\text{RESET}}$.</p>
GPIOC0	3	EXTAL/CLKIN0	<p>Port C GPIO — This GPIO pin can be individually programmed as an input or output pin.</p> <p>EXTAL — External Crystal Oscillator Input. This input connects the internal crystal oscillator input to an external crystal or ceramic resonator.</p> <p>CLKIN0 — This pin serves as an external clock input 0.</p> <p>After reset, the default state is GPIOC0.</p>
GPIOC1	4	XTAL	<p>Port C GPIO — This GPIO pin can be individually programmed as an input or output pin.</p> <p>XTAL — External Crystal Oscillator Output. This output connects the internal crystal oscillator output to an external crystal or ceramic resonator.</p> <p>After reset, the default state is GPIOC1.</p>
GPIOC2	5	TXD0/XB_OUT11(TB0)/XB_IN2/CLKO0	<p>Port C GPIO — This GPIO pin can be individually programmed as an input or output pin.</p> <p>TXD0 — The SCI0 transmit data output or transmit/receive in single wire operation.</p> <p>XB_OUT11 — Crossbar module output 11 only on WCT1001A. TB0 — Quad timer module B channel 0 input/output only on WCT1003A.</p> <p>XB_IN2 — Crossbar module input 2.</p> <p>CLKO0 — This is a buffered clock output 0; the clock source is selected by clock out select (CLKOSEL) bits in the clock output select register (CLKOUT) of the SIM.</p> <p>After reset, the default state is GPIOC2.</p>
GPIOF8	6	RXD0/XB_OUT10(TB1)/CMPD_O/PWM_2X	<p>Port F GPIO — This GPIO pin can be individually programmed as an input or output pin.</p> <p>RXD0 — The SCI0 receive data input.</p> <p>XB_OUT10 — Crossbar module output 10 only on WCT1001A. TB1 — Quad timer module B channel 1 input/output only on WCT1003A.</p> <p>CMPD_O — Analog comparator D output.</p> <p>PWM_2X — NanoEdge eFlexPWM sub-module 2 output X or input capture X only on WCT1001A.</p> <p>After reset, the default state is GPIOF8.</p>
GPIOC3	7	TA0/CMPA_O/RXD0/CLKIN1	<p>Port C GPIO — This GPIO pin can be individually programmed as an input or output pin.</p> <p>TA0 — Quad timer module A channel 0 input/output.</p> <p>CMPA_O — Analog comparator A output.</p> <p>RXD0 — The SCI0 receive data input.</p>

			<p>CLKIN1 — This pin serves as an external clock input 1.</p> <p>After reset, the default state is GPIOC3.</p>
GPIOC4	8	TA1/CMPB_O/XB_IN6(XB_IN8)/ <u>EWM_OUT</u>	<p>Port C GPIO — This GPIO pin can be individually programmed as an input or output pin.</p> <p>TA1 — Quad timer module A channel 1 input/output.</p> <p>CMPB_O — Analog comparator B output.</p> <p>XB_IN6 — Crossbar module input 6 only on WCT1001A. XB_IN8 — Crossbar module input 8 only on WCT1003A.</p> <p><u>EWM_OUT</u> — External watchdog monitor output.</p> <p>After reset, the default state is GPIOC4.</p>
GPIOA7	9	ANA7&CMPD_IN3(ANC11)	<p>Port A GPIO — This GPIO pin can be individually programmed as an input or output pin.</p> <p>ANA7&CMPD_IN3 — Analog input to channel 7 of ADCA and input 3 of analog comparator D only on WCT1001A. When used as an analog input, the signal goes to the ANA7 and CMPD_IN3.</p> <p>ANA7&ANC11 — Analog input to channel 7 of ADCA and analog input 11 of ADCC only on WCT1003A. When used as an analog input, the signal goes to the ANA7 and ANC11.</p> <p>After reset, the default state is GPIOA7.</p>
GPIOA6	10	ANA6&CMPD_IN2(ANC10)	<p>Port A GPIO — This GPIO pin can be individually programmed as an input or output pin.</p> <p>ANA6&CMPD_IN2 — Analog input to channel 6 of ADCA and input 2 of analog comparator D only on WCT1001A. When used as an analog input, the signal goes to the ANA6 and CMPD_IN2.</p> <p>ANA6&ANC10 — Analog input to channel 6 of ADCA and analog input 10 of ADCC only on WCT1003A. When used as an analog input, the signal goes to the ANA6 and ANC10.</p> <p>After reset, the default state is GPIOA6.</p>
GPIOA5	11	ANA5&CMPD_IN1(ANC9)	<p>Port A GPIO — This GPIO pin can be individually programmed as an input or output pin.</p> <p>ANA5&CMPD_IN1 — Analog input to channel 5 of ADCA and input 1 of analog comparator D only on WCT1001A. When used as an analog input, the signal goes to the ANA5 and CMPD_IN1.</p> <p>ANA5&ANC9 — Analog input to channel 5 of ADCA and analog input 9 of ADCC only on WCT1003A. When used as an analog input, the signal goes to the ANA5 and ANC9.</p> <p>After reset, the default state is GPIOA5.</p>
GPIOA4	12	ANA4&CMPD_IN0&ANC8	<p>Port A GPIO — This GPIO pin can be individually programmed as an input or output pin.</p> <p>ANA4&CMPD_IN0 — Analog input to channel 4 of ADCA and input 0 of analog comparator D only on WCT1001A. When used as an analog input, the signal goes to the ANA4 and CMPD_IN0.</p> <p>ANA4&CMPD_IN0&ANC8 — Analog input to channel 4 of ADCA and input 0 of analog comparator D and analog input to channel 8 of ADCC only on WCT1003A. When used as an analog input, the signal goes to the ANA4 and CMPD_IN0 and ANC8.</p>

			After reset, the default state is GPIOA4.
GPIOA0	13	ANA0&CMPA_IN3/CMPC_O	<p>Port A GPIO — This GPIO pin can be individually programmed as an input or output pin.</p> <p>ANA0&CMPA_IN3 — Analog input to channel 0 of ADCA and input 3 of analog comparator A. When used as an analog input, the signal goes to the ANA0 and CMPA_IN3.</p> <p>CMPC_O — Analog comparator C output.</p> <p>After reset, the default state is GPIOA0.</p>
GPIOA1	14	ANA1&CMPA_IN0	<p>Port A GPIO — This GPIO pin can be individually programmed as an input or output pin.</p> <p>ANA1 and CMPA_IN0 — Analog input to channel 1 of ADCA and input 0 of analog comparator A. When used as an analog input, the signal goes to the ANA1 and CMPA_IN0.</p> <p>After reset, the default state is GPIOA1.</p>
GPIOA2	15	ANA2&VREFHA&CMPA_IN1	<p>Port A GPIO — This GPIO pin can be individually programmed as an input or output pin.</p> <p>ANA2&VREFHA&CMPA_IN1 — Analog input to channel 2 of ADCA and analog references high of ADCA and input 1 of analog comparator A. When used as an analog input, the signal goes to ANA2 and VREFHA and CMPA_IN1. ADC control register configures this input as ANA2 or VREFHA.</p> <p>After reset, the default state is GPIOA2.</p>
GPIOA3	16	ANA3&VREFLA&CMPA_IN2	<p>Port A GPIO — This GPIO pin can be individually programmed as an input or output pin.</p> <p>ANA3&VREFLA&CMPA_IN2 — Analog input to channel 3 of ADCA and analog references low of ADCA and input 2 of analog comparator A. When used as an analog input, the signal goes to ANA3 and VREFLA and CMPA_IN2. ADC control register configures this input as ANA3 or VREFLA.</p> <p>After reset, the default state is GPIOA3.</p>
GPIOB7	17	ANB7&CMPB_IN2&ANC15	<p>Port B GPIO — This GPIO pin can be individually programmed as an input or output pin.</p> <p>ANB7&CMPB_IN2 — Analog input to channel 7 of ADCB and input 2 of analog comparator B only on WCT1001A. When used as an analog input, the signal goes to the ANB7 and CMPB_IN2.</p> <p>ANB7&CMPB_IN2&ANC15 — Analog input to channel 7 of ADCB and input 2 of analog comparator B and analog input to channel 15 of ADCC only on WCT1003A. When used as an analog input, the signal goes to the ANB7 and CMPB_IN2 and ANC15.</p> <p>After reset, the default state is GPIOB7.</p>
GPIOC5	18	DAC_O/XB_IN7	<p>Port C GPIO — This GPIO pin can be individually programmed as an input or output pin.</p> <p>DAC_O — 12-bit Digital-to-Analog Converter output. For WCT1001A, it's DACA output.</p> <p>XB_IN7 — Crossbar module input 7.</p> <p>After reset, the default state is GPIOC5.</p>
GPIOB6	19	ANB6&CMPB_IN1&ANC14	<p>Port B GPIO — This GPIO pin can be individually programmed as an input or output pin.</p>

			<p>ANB6&CMPB_IN1 — Analog input to channel 6 of ADCB and input 1 of analog comparator B only on WCT1001A. When used as an analog input, the signal goes to the ANB6 and CMPB_IN1.</p> <p>ANB6&CMPB_IN1&ANC14 — Analog input to channel 6 of ADCB and input 1 of analog comparator B and analog input to channel 14 of ADCC only on WCT1003A. When used as an analog input, the signal goes to the ANB6 and CMPB_IN1 and ANC14.</p> <p>After reset, the default state is GPIOB6.</p>
GPIOB5	20	ANB5&CMPC_IN2&ANC13	<p>Port B GPIO — This GPIO pin can be individually programmed as an input or output pin.</p> <p>ANB5&CMPC_IN2 — Analog input to channel 5 of ADCB and input 2 of analog comparator C only on WCT1001A. When used as an analog input, the signal goes to the ANB5 and CMPC_IN2.</p> <p>ANB5&CMPC_IN2&ANC13 — Analog input to channel 5 of ADCB and input 2 of analog comparator C and analog input to channel 13 of ADCC only on WCT1003A. When used as an analog input, the signal goes to the ANB5 and CMPC_IN2 and ANC13.</p> <p>After reset, the default state is GPIOB5.</p>
GPIOB4	21	ANB4&CMPC_IN1&ANC12	<p>Port B GPIO — This GPIO pin can be individually programmed as an input or output pin.</p> <p>ANB4&CMPC_IN1 — Analog input to channel 4 of ADCB and input 1 of analog comparator C only on WCT1001A. When used as an analog input, the signal goes to the ANB4 and CMPC_IN1.</p> <p>ANB4&CMPC_IN1&ANC12 — Analog input to channel 4 of ADCB and input 1 of analog comparator C and analog input to channel 12 of ADCC only on WCT1003A. When used as an analog input, the signal goes to the ANB4 and CMPC_IN1 and ANC12.</p> <p>After reset, the default state is GPIOB4.</p>
VDDA	22	-	Analog Power — This pin supplies 3.3 V power to the analog modules. It must be connected to a clean analog power supply.
VSSA	23	-	Analog Ground — This pin supplies an analog ground to the analog modules. It must be connected to a clean power supply.
GPIOB0	24	ANB0&CMPB_IN3	<p>Port B GPIO — This GPIO pin can be individually programmed as an input or output pin.</p> <p>ANB0&CMPB_IN3 — Analog input to channel 0 of ADCB and input 3 of analog comparator B. When used as an analog input, the signal goes to ANB0 and CMPB_IN3.</p> <p>After reset, the default state is GPIOB0.</p>
GPIOB1	25	ANB1&CMPB_IN0/DACB_O	<p>Port B GPIO — This GPIO pin can be individually programmed as an input or output pin.</p> <p>ANB1&CMPB_IN0 — Analog input to channel 1 of ADCB and input 0 of analog comparator B. When used as an analog input, the signal goes to ANB1 and CMPB_IN0.</p> <p>DACB_O — 12-bit Digital-to-Analog Converter B output only on WCT1001A.</p> <p>After reset, the default state is GPIOB1.</p>
VCAP1	26	-	Connect a 2.2 µF or greater bypass capacitor between this pin and VSS to stabilize the core voltage regulator output required for proper device operation.
GPIOB2	27	ANB2&VREFH	Port B GPIO — This GPIO pin can be individually programmed as an input

		B&CMPC_IN3	<p>or output pin.</p> <p>ANB2&VREFHB&CMPC_IN3 — Analog input to channel 2 of ADCB and analog references high of ADCB and input 3 of analog comparator C. When used as an analog input, the signal goes to ANB2 and VREFHB and CMPC_IN3. ADC control register configures this input as ANB2 or VREFHB.</p> <p>After reset, the default state is GPIOB2.</p>
GPIOB3	28	ANB3&VREFLB &CMPC_IN0	<p>Port B GPIO — This GPIO pin can be individually programmed as an input or output pin.</p> <p>ANB3&VREFLB&CMPC_IN0 — Analog input to channel 3 of ADCB and analog references low of ADCB and input 0 of analog comparator C. When used as an analog input, the signal goes to ANB3 and VREFLB and CMPC_IN0. ADC control register configures this input as ANB3 or VREFLB.</p> <p>After reset, the default state is GPIOB3.</p>
VDD1	29	-	I/O Power — Supplies 3.3 V power to on-chip digital module.
VSS1	30	-	I/O Ground — Provides ground on-chip digital module.
GPIOC6	31	TA2/XB_IN3/C MP_REF/SS0	<p>Port C GPIO — This GPIO pin can be individually programmed as an input or output pin.</p> <p>TA2 — Quad timer module A channel 2 input/output.</p> <p>XB_IN3 — Crossbar module input 3.</p> <p>CMP_REF — Input 5 of analog comparator A and B and C and D.</p> <p>SS0 — SS0 is used in slave mode to indicate to the SPI0 module that the current transfer is to be received. This signal is only on WCT1001A.</p> <p>After reset, the default state is GPIOC6.</p>
GPIOC7	32	SS0/TXD0/XB_I N8	<p>Port C GPIO — This GPIO pin can be individually programmed as an input or output pin.</p> <p>SS0 — SS0 is used in slave mode to indicate to the SPI0 module that the current transfer is to be received.</p> <p>TXD0 — SCI0 transmit data output or transmit/receive in single wire operation.</p> <p>XB_IN8 — Crossbar module input 8 only on WCT1001A.</p> <p>After reset, the default state is GPIOC7.</p>
GPIOC8	33	MISO0 /RXD0/XB_IN9/ XB_OUT6	<p>Port C GPIO — This GPIO pin can be individually programmed as an input or output pin.</p> <p>MISO0 — Master in/slave out. In master mode, this pin serves as the data input. In slave mode, this pin serves as the data output. The MISO0 line of a slave device is placed in the high-impedance state if the slave device is not selected.</p> <p>RXD0 — SCI0 receive data input.</p> <p>XB_IN9 — Crossbar module input 9.</p> <p>XB_OUT6 — Crossbar module output 6 only on WCT1001A.</p> <p>After reset, the default state is GPIOC8.</p>

GPIOC9	34	SCLK0/XB_IN4/ TXD0/XB_OUT 8	<p>Port C GPIO — This GPIO pin can be individually programmed as an input or output pin.</p> <p>SCLK0 — The SPI0 serial clock. In master mode, this pin serves as an output, clocking slaved listeners. In slave mode, this pin serves as the data clock input.</p> <p>XB_IN4 — Crossbar module input 4.</p> <p>TXD0 — SCI0 transmit data output or transmit/receive in single wire operation. This signal is only on WCT1001A.</p> <p>XB_OUT8 — Crossbar module output 8 only on WCT1001A.</p> <p>After reset, the default state is GPIOC9.</p>
GPIOC10	35	MOSI0 /XB_IN5/MISO0 /XB_OUT9	<p>Port C GPIO — This GPIO pin can be individually programmed as an input or output pin.</p> <p>MOSI0 — Master out/slave in. In master mode, this pin serves as the data output. In slave mode, this pin serves as the data input.</p> <p>XB_IN5 — Crossbar module input 5.</p> <p>MISO0 — Master in/slave out. In master mode, this pin serves as the data input. In slave mode, this pin serves as the data output. The MISO0 line of a slave device is placed in the high-impedance state if the slave device is not selected.</p> <p>XB_OUT9 — Crossbar module output 9 only on WCT1001A.</p> <p>After reset, the default state is GPIOC10.</p>
GPIOF0	36	XB_IN6/TB2/SC LK1	<p>Port F GPIO — This GPIO pin can be individually programmed as an input or output pin.</p> <p>XB_IN6 — Crossbar module input 6.</p> <p>TB2 — Quad timer module B channel 2 input/output only on WCT1003A.</p> <p>SCLK1 — The SPI1 serial clock. In master mode, this pin serves as an output, clocking slaved listeners. In slave mode, this pin serves as the data clock input.</p> <p>After reset, the default state is GPIOF0.</p>
GPIOC11	37	CAN_TX/SCL0(SCL1)/TXD1	<p>Port C GPIO — This GPIO pin can be individually programmed as an input or output pin.</p> <p>CANTX — CAN transmit data output.</p> <p>SCL0 — IIC0 serial clock only on WCT1001A. SCL1 — IIC1 serial clock only on WCT1003A.</p> <p>TXD1 — SCI1 transmit data output or transmit/receive in single wire operation.</p> <p>After reset, the default state is GPIOC11.</p>
GPIOC12	38	CAN_RX/SDA0(SDA1)/RXD1	<p>Port C GPIO — This GPIO pin can be individually programmed as an input or output pin.</p> <p>CANRX — CAN receive data input.</p> <p>SDA0 — IIC0 serial data line only on WCT1001A.</p>

			<p>SDA1 — IIC1 serial data line only on WCT1003A.</p> <p>RXD1 — SCI1 receive data input.</p> <p>After reset, the default state is GPIOC12.</p>
GPIOF2	39	SCL0(SCL1)/XB_OUT6/MISO1	<p>Port F GPIO — This GPIO pin can be individually programmed as an input or output pin.</p> <p>SCL0 — IIC0 serial clock only on WCT1001A. SCL1 — IIC1 serial clock only on WCT1003A.</p> <p>XB_OUT6 — Crossbar module output 6.</p> <p>MISO1 — Master in/slave out. In master mode, this pin serves as the data input. In slave mode, this pin serves as the data output. The MISO1 line of a slave device is placed in the high-impedance state if the slave device is not selected. This signal is only on WCT1001A.</p> <p>After reset, the default state is GPIOF2.</p>
GPIOF3	40	SDA0(SDA1)/XB_OUT7/MOSI1	<p>Port F GPIO — This GPIO pin can be individually programmed as an input or output pin.</p> <p>SDA0 — IIC0 serial data line only on WCT1001A. SDA1 — IIC1 serial data line only on WCT1003A.</p> <p>XB_OUT7 — Crossbar module output 7.</p> <p>MOSI1 — Master out/slave in. In master mode, this pin serves as the data output. In slave mode, this pin serves as the data input. This signal is only on WCT1001A.</p> <p>After reset, the default state is GPIOF3.</p>
GPIOF4	41	TXD1/XB_OUT8/PWM_0X/PWM_FAULT6	<p>Port F GPIO — This GPIO pin can be individually programmed as an input or output pin.</p> <p>TXD1 — The SCI1 transmit data output or transmit/receive in single wire operation.</p> <p>XB_OUT8 — Crossbar module output 8.</p> <p>PWM_0X — NanoEdge eFlexPWM sub-module 0 output X or input capture X only on WCT1001A.</p> <p>PWM_FAULT6 — NanoEdge eFlexPWM fault input 6 only on WCT1001A.</p> <p>After reset, the default state is GPIOF4.</p>
GPIOF5	42	RXD1/XB_OUT9/PWM_1X/PWM_FAULT7	<p>Port F GPIO — This GPIO pin can be individually programmed as an input or output pin.</p> <p>RXD1 — The SCI1 receive data input.</p> <p>XB_OUT9 — Crossbar module output 9.</p> <p>PWM_1X — NanoEdge eFlexPWM sub-module 1 output X or input capture X only on WCT1001A.</p> <p>PWM_FAULT7 — NanoEdge eFlexPWM fault input 7 only on WCT1001A.</p> <p>After reset, the default state is GPIOF5.</p>
VSS2	43	-	I/O Ground — Provides ground to on-chip digital module.

VDD2	44	-	I/O Power — Supplies 3.3 V power to on-chip digital module.
GPIOE0	45	PWM_0B	Port E GPIO — This GPIO pin can be individually programmed as an input or output pin. PWM_0B — NanoEdge eFlexPWM sub-module 0 output B or input capture B. After reset, the default state is GPIOE0.
GPIOE1	46	PWM_0A	Port E GPIO — This GPIO pin can be individually programmed as an input or output pin. PWM_0A — NanoEdge eFlexPWM sub-module 0 output A or input capture A. After reset, the default state is GPIOE1.
GPIOE2	47	PWM_1B	Port E GPIO — This GPIO pin can be individually programmed as an input or output pin. PWM_1B — NanoEdge eFlexPWM sub-module 1 output B or input capture B. After reset, the default state is GPIOE2.
GPIOE3	48	PWM_1A	Port E GPIO — This GPIO pin can be individually programmed as an input or output pin. PWM_1A — NanoEdge eFlexPWM sub-module 1 output A or input capture A. After reset, the default state is GPIOE3.
GPIOC13	49	TA3/XB_IN6/ EWM_OUT	Port C GPIO — This GPIO pin can be individually programmed as an input or output pin. TA3 — Quad timer module A channel 3 input/output. XB_IN6 — Crossbar module input 6. EWM_OUT — External watchdog monitor output. After reset, the default state is GPIOC13.
GPIOF1	50	CLKO1/XB_IN7/ CMPD_O	Port F GPIO — This GPIO pin can be individually programmed as an input or output pin. CLKO1 — This is a buffered clock output 1; the clock source is selected by clock out select (CLKOSEL) bits in the clock output select register (CLKOUT) of the SIM. XB_IN7 — Crossbar module input 7. CMPD_O — Analog comparator D output. After reset, the default state is GPIOF1.
GPIOE4	51	PWM_2B/XB_I N2	Port E GPIO — This GPIO pin can be individually programmed as an input or output pin. PWM_2B — NanoEdge eFlexPWM sub-module 2 output B or input capture B. XB_IN2 — Crossbar module input 2. After reset, the default state is GPIOE4.

GPIOE5	52	PWM_2A/XB_IN3	<p>Port E GPIO — This GPIO pin can be individually programmed as an input or output pin.</p> <p>PWM_2A — NanoEdge eFlexPWM sub-module 2 output A or input capture A.</p> <p>XB_IN3 — Crossbar module input 3.</p> <p>After reset, the default state is GPIOE5.</p>
GPIOE6	53	PWM_3B/XB_IN4	<p>Port E GPIO — This GPIO pin can be individually programmed as an input or output pin.</p> <p>PWM_3B — NanoEdge eFlexPWM sub-module 3 output B or input capture B.</p> <p>XB_IN4 — Crossbar module input 4.</p> <p>After reset, the default state is GPIOE6.</p>
GPIOE7	54	PWM_3A/XB_IN5	<p>Port E GPIO — This GPIO pin can be individually programmed as an input or output pin.</p> <p>PWM_3A — NanoEdge eFlexPWM sub-module 3 output A or input capture A.</p> <p>XB_IN5 — Crossbar module input 5.</p> <p>After reset, the default state is GPIOE7.</p>
GPIOC14	55	SDA0/XB_OUT4/PWM_FAULT4	<p>Port C GPIO — This GPIO pin can be individually programmed as an input or output pin.</p> <p>SDA0 — IIC0 serial data line.</p> <p>XB_OUT4 — Crossbar module output 4.</p> <p>PWM_FAULT4 — NanoEdge eFlexPWM fault input 4 only on WCT1001A.</p> <p>After reset, the default state is GPIOC14.</p>
GPIOC15	56	SCL0/XB_OUT5/PWM_FAULT5	<p>Port C GPIO — This GPIO pin can be individually programmed as an input or output pin.</p> <p>SCL0 — IIC0 serial clock.</p> <p>XB_OUT5 — Crossbar module output 5.</p> <p>PWM_FAULT5 — NanoEdge eFlexPWM fault input 5 only on WCT1001A.</p> <p>After reset, the default state is GPIOC15.</p>
VCAP2	57	-	<p>Connect a 2.2 μF or greater bypass capacitor between this pin and VSS to stabilize the core voltage regulator output required for proper device operation.</p>
GPIOF6	58	TB2/PWM_3X/XB_IN2	<p>Port F GPIO — This GPIO pin can be individually programmed as an input or output pin.</p> <p>TB2 — Quad timer module B channel 2 input/output only on WCT1003A.</p> <p>PWM_3X — NanoEdge eFlexPWM sub-module 3 output X or input capture X.</p> <p>XB_IN2 — Crossbar module input 2.</p> <p>After reset, the default state is GPIOF6.</p>

GPIOF7	59	TB3/CMPC_O/ SS1/XB_IN3	<p>Port F GPIO — This GPIO pin can be individually programmed as an input or output pin.</p> <p>TB3 — Quad timer module B channel 3 input/output only on WCT1003A.</p> <p>CMPC_O— Analog comparator C output.</p> <p>SS1 — SS1 is used in slave mode to indicate to the SPI1 module that the current transfer is to be received.</p> <p>XB_IN3 — Crossbar module input 3.</p> <p>After reset, the default state is GPIOF7.</p>
VDD3	60	-	I/O Power — Supplies 3.3 V power to on-chip digital module.
VSS3	61	-	I/O Ground — Provides ground to on-chip digital module.
TDO	62	GPIOD1	<p>Test Data Output — This tri-stateable output pin provides a serial output data stream from the JTAG/EOnCE port. It is driven in the shift-IR and shift-DR controller states and changes on the falling edge of TCK.</p> <p>Port D GPIO — This GPIO pin can be individually programmed as an input or output pin.</p> <p>After reset, the default state is TDO.</p>
TMS	63	GPIOD3	<p>Test Mode Select Input — This input pin is used to sequence the JTAG TAP controller's state machine. It is sampled on the rising edge of TCK and has an on-chip pull-up resistor.</p> <p>Port D GPIO — This GPIO pin can be individually programmed as an input or output pin.</p> <p>After reset, the default state is TMS.</p> <p>NOTE: Always tie the TMS pin to VDD through a 2.2 kΩ resistor if need to keep on-board debug capability. Otherwise, directly tie to VDD.</p>
TDI	64	GPIOD0	<p>Test Data Input — This input pin provides a serial input data stream to the JTAG/EOnCE port. It is sampled on the rising edge of TCK and has an on-chip pull-up resistor.</p> <p>Port D GPIO — This GPIO pin can be individually programmed as an input or output pin.</p> <p>After reset, the default state is TDI.</p>

4.5 Ordering Information

Table 10 lists the pertinent information needed to place an order. Consult a Freescale Semiconductor sales office to determine availability and to order this device.

Table 10. MWCT100xAVLH Ordering Information

Device	Supply Voltage	Package Type	Pin Count	Ambient Temp.	Order Number
MWCT1001AVLH	3.0 to 3.6V	LQFP	64	-40 to +105°C	MWCT1001AVLH
MWCT1003AVLH	3.0 to 3.6V	LQFP	64	-40 to +105°C	MWCT1003AVLH

4.6 Package Outline Drawing

To find a package drawing, go to freescale.com and perform a keyword search for the drawing's document number of 98ASS23234W.

5 Software Library

The software for WCT100xA is matured and tested for production ready. Freescale provides a Wireless Charging Transmitter (WCT) software library for speeding user designs. In this library, low level drivers of HAL (Hardware Abstract Layer), callback functions for library access are open to user. About the software API and library details, see the *WCT1001A/WCT1003A Transmitter Library User's Guide* (WCT100XALIBUG).

5.1 Memory Map

WCT100xA has large on-chip Flash memory and RAM for user design. Besides wireless charging transmitter library code, the user can develop private functions and link it to library through predefined APIs.

Table 11. WCT100xA Memory Footprint (CodeWarrior V10.6, code size optimization level 4)

Part	Memory	Total Size	Library Size	FreeMASTER Size	EEPROM Size	Free Size
WCT1001A	Flash	64 Kbytes	22.2 Kbytes	1.5 Kbytes	1 Kbytes	39.3 Kbytes
	RAM	8 Kbytes	2.5 Kbytes	0.1 Kbytes	0 Kbytes	5.4 Kbytes
WCT1003A	Flash	288 Kbytes	22.2 Kbytes	1.5 Kbytes	1 Kbytes	263.3 Kbytes
	RAM	32 Kbytes	1.2 Kbytes	0.1 Kbytes	0 Kbytes	30.7 Kbytes

5.2 Software Library and API Description

For more and detailed information about WCT software library and API definition, see the *WCT1001A/WCT1003A Transmitter Library User's Guide* (WCT100XALIBUG).

6 Design Considerations

6.1 Electrical Design Considerations

To ensure correct operations on the device and system, pay attention to the following points:

- The minimum bypass requirement is to place 0.01 - 0.1 μ F capacitors positioned as near as possible to the package supply pins. The recommended bypass configuration is to place one bypass capacitor on each of the VDD/VSS pairs, including VDDA/VSSA. Ceramic and tantalum capacitors tend to provide better tolerances.

- Bypass the VDD and VSS with approximately 10 μ F, plus the number of 0.1 μ F ceramic capacitors.
- Consider all device loads as well as parasitic capacitance due to PCB traces when calculating capacitance. This is especially critical in systems with higher capacitive loads that could create higher transient currents in the VDD and VSS circuits.
- Take special care to minimize noise levels on the VDDA and VSSA pins.
- It is recommended to use separate power planes for VDD and VDDA and use separate ground planes for VSS and VSSA. Connect the separate analog and digital power and ground planes as near as possible to power supply outputs. If an analog circuit and digital circuit are powered by the same power supply, you should connect a small inductor or ferrite bead in serial with VDDA trace.
- If desired, connect an external RC circuit to the RESET pin. The resistor value should be in the range of 4.7 k Ω – 10 k Ω ; and the capacitor value should be in the range of 0.1 μ F – 4.7 μ F.
- Add a 2.2 k Ω external pull-up on the TMS pin of the JTAG port to keep device in a restate during normal operation if JTAG converter is not present.
- During reset and after reset but before I/O initialization, all I/O pins are at input mode with internal weak pull-up.
- To eliminate PCB trace impedance effect, each ADC input should have a no less than 33pF/10 Ω RC filter.
- To assure chip reliable operation, reserve enough margin for chip electrical design. Figure 6 shows the relationship between electrical ratings and electrical operating characteristics for correct chip operation.

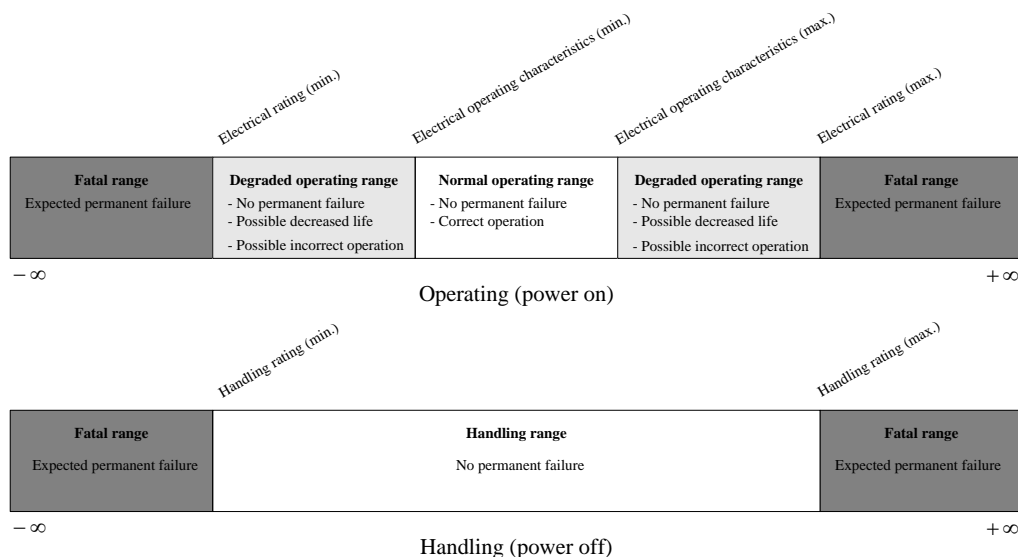

Figure 5. Relationship between Ratings and Operating Characteristics

6.2 PCB Layout Considerations

- Provide a low-impedance path from the board power supply to each VDD pin on the device and from the board ground to each VSS pin.
- Ensure that capacitor leads and associated printed circuit traces that connect to the chip VDD and VSS pins are as short as possible.
- PCB trace lengths should be minimal for high-frequency signals.
- Physically separate analog components from noisy digital components by ground planes. Do not place an analog trace in parallel with digital traces. Place an analog ground trace around an analog signal trace to isolate it from digital traces.
- The decoupling capacitors of 0.1 μ F must be placed on the VDD pins as close as possible, and place those ceramic capacitors on the same PCB layer with WCT100xA device. VIA is not recommended between the VDD pins and decoupling capacitors.
- The WCT100xA bottom EP pad should be soldered to the ground plane, which will make the system more stable, and VIA matrix method can be used to connect this pad to the ground plane.
- As the wireless charging system functions as a switching-mode power supply, the power components layout is very important for the whole system power transfer efficiency and EMI performance. The power routing loop should be as small and short as possible. Especially for the resonant network, the traces of this circuit should be short and wide, and the current loop should be optimized smaller for the MOSFETs, resonant capacitor and primary coil. Another important thing is that the control circuit and power circuit should be separated.

6.3 Thermal Design Considerations

WCT100xA power consumption is not so critical, so there is not additional part needed for power dissipation. However, the power inverter needs the additional PCB Cu copper to dissipate the heat, so good thermal package MOSFET is recommended, such as DFN package, and for the resonant capacitor, C0G material, and 1206 or 1210 package are recommended to meet the thermal requirement. The worst thermal case is on the inverter, so the user should make some special actions to dissipate the heat for good transmitter system thermal performance.

7 References and Links

7.1 References

- *WCT1001A/WCT1003A Automotive A13 Wireless Charging Application User's Guide* (WCT100XAWCAUG)
- *WCT1001A/WCT1003A Transmitter Library User's Guide* (WCT100XALIBUG)
- *WCT1001A/WCT1003A Run-Time Debug User's Guide* (WCT100XARTDUG)

-
- *WPC Low Power Wireless Transfer System Description Part 1: Interface Definition Version 1.1*

7.2 Useful Links

- freescale.com
- freescale.com/wirelesscharging
- www.wirelesspowerconsortium.com

How to Reach Us:

Home Page:

freescale.com

Web Support:

freescale.com/support

Information in this document is provided solely to enable system and software implementers to use Freescale products. There are no express or implied copyright licenses granted hereunder to design or fabricate any integrated circuits based on the information in this document.

Freescale reserves the right to make changes without further notice to any products herein. Freescale makes no warranty, representation, or guarantee regarding the suitability of its products for any particular purpose, nor does Freescale assume any liability arising out of the application or use of any product or circuit, and specifically disclaims any and all liability, including without limitation consequential or incidental damages. "Typical" parameters that may be provided in Freescale data sheets and/or specifications can and do vary in different applications, and actual performance may vary over time. All operating parameters, including "typicals," must be validated for each customer application by customer's technical experts. Freescale does not convey any license under its patent rights nor the rights of others. Freescale sells products pursuant to standard terms and conditions of sale, which can be found at the following address: freescale.com/SalesTermsandConditions.

Freescale and the Freescale logo are trademarks of Freescale Semiconductor, Inc., Reg. U.S. Pat. & Tm. Off. All other product or service names are the property of their respective owners.

©2014 Freescale Semiconductor, Inc.

AMEYA360

Components Supply Platform

Authorized Distribution Brand :



Website :

Welcome to visit www.ameya360.com

Contact Us :

➤ Address :

401 Building No.5, JiuGe Business Center, Lane 2301, Yishan Rd
Minhang District, Shanghai , China

➤ Sales :

Direct +86 (21) 6401-6692

Email amall@ameya360.com

QQ 800077892

Skype [ameyasales1](#) [ameyasales2](#)

➤ Customer Service :

Email service@ameya360.com

➤ Partnership :

Tel +86 (21) 64016692-8333

Email mkt@ameya360.com