



Dual 10-Bit, 20MSPs, 3V, Low-Power ADC with Internal Reference and Multiplexed Parallel Outputs

MAX1185

General Description

The MAX1185 is a 3V, dual 10-bit analog-to-digital converter (ADC) featuring fully-differential wideband track-and-hold (T/H) inputs, driving two pipelined, nine-stage ADCs. The MAX1185 is optimized for low-power, high dynamic performance applications in imaging, instrumentation, and digital communication applications. This ADC operates from a single 2.7V to 3.6V supply, consuming only 105mW while delivering a typical signal-to-noise ratio (SNR) of 59.5dB at an input frequency of 7.5MHz and a sampling rate of 20MSPs. Digital outputs A and B are updated alternating on the rising (CHA) and falling (CHB) edge of the clock. The T/H driven input stages incorporate 400MHz (-3dB) input amplifiers. The converters may also be operated with single-ended inputs. In addition to low operating power, the MAX1185 features a 2.8mA sleep mode as well as a 1µA power-down mode to conserve power during idle periods.

An internal 2.048V precision bandgap reference sets the full-scale range of the ADC. A flexible reference structure allows the use of this internal or an externally derived reference, if desired for applications requiring increased accuracy or a different input voltage range.

The MAX1185 features parallel, multiplexed, CMOS-compatible three-state outputs. The digital output format can be set to two's complement or straight offset binary through a single control pin. The device provides for a separate output power supply of 1.7V to 3.6V for flexible interfacing. The MAX1185 is available in a 7mm x 7mm, 48-pin TQFP package, and is specified for the extended industrial (-40°C to +85°C) temperature range.

Pin-compatible, nonmultiplexed, high-speed versions of the MAX1185 are also available. Refer to the MAX1180 data sheet for 105MSPs, the MAX1181 data sheet for 80MSPs, the MAX1182 data sheet for 65MSPs, the MAX1183 data sheet for 40MSPs, and the MAX1184 data sheet for 20MSPs.

Applications

- High Resolution Imaging
- I/Q Channel Digitization
- Multichannel IF Sampling
- Instrumentation
- Video Application
- Ultrasound

Features

- ◆ Single 3V Operation
- ◆ Excellent Dynamic Performance:
 - 59.5dB SNR at $f_{IN} = 7.5\text{MHz}$
 - 74dB SFDR at $f_{IN} = 7.5\text{MHz}$
- ◆ Low Power:
 - 35mA (Normal Operation)
 - 2.8mA (Sleep Mode)
 - 1µA (Shutdown Mode)
- ◆ 0.02dB Gain and 0.25° Phase Matching
- ◆ Wide $\pm 1\text{Vp-p}$ Differential Analog Input Voltage Range
- ◆ 400MHz, -3dB Input Bandwidth
- ◆ On-Chip 2.048V Precision Bandgap Reference
- ◆ Single 10-Bit Bus for Multiplexed, Digital Outputs
- ◆ User-Selectable Output Format—Two's Complement or Offset Binary
- ◆ 48-Pin TQFP Package with Exposed Pad for Improved Thermal Dissipation

Ordering Information

PART	TEMP RANGE	PIN-PACKAGE
MAX1185ECM	-40°C to +85°C	48 TQFP-EP*
MAX1185ECM+	-40°C to +85°C	48 TQFP-EP*
MAX1185ECM/V+	-40°C to +85°C	48 TQFP-EP*

*EP = Exposed pad.

+Denotes a lead(Pb)-free/RoHS-compliant package.

/V denotes an automotive qualified part.

Pin-Compatible Versions table at end of data sheet.

Pin Configuration

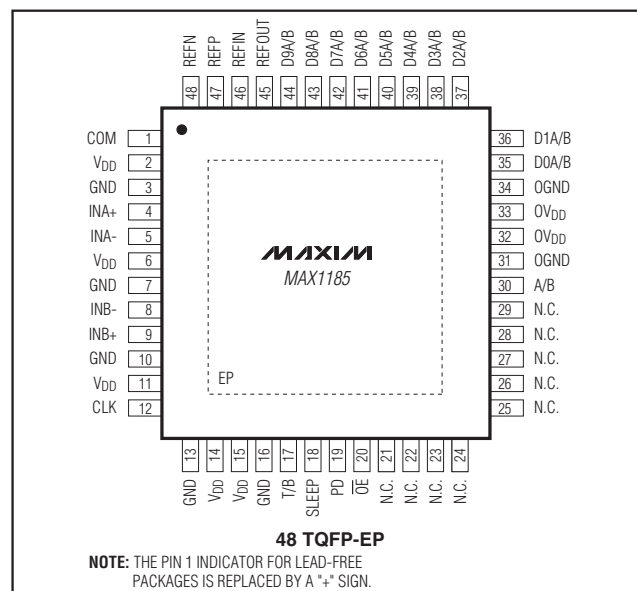

Dual 10-Bit, 20MSPS, 3V, Low-Power ADC with Internal Reference and Multiplexed Parallel Outputs

ABSOLUTE MAXIMUM RATINGS

V _{DD} , OV _{DD} to GND	-0.3V to +3.6V	Operating Temperature Range	-40°C to +85°C
OGND to GND	-0.3V to +0.3V	Junction Temperature	+150°C
INA+, INA-, INB+, INB- to GND	-0.3V to V _{DD}	Storage Temperature Range	-60°C to +150°C
REFIN, REFOUT, REFP, REFN, COM, CLK to GND	-0.3V to (V _{DD} + 0.3V)	Lead Temperature (soldering, 10s)	+300°C
OE, PD, SLEEP, T/B, D9A/B–D0A/B, A/B to OGND	-0.3V to (OV _{DD} + 0.3V)	Soldering Temperature (reflow)	
		Lead(Pb)-free	+260°C
Continuous Power Dissipation (T _A = +70°C)		Containing lead(Pb)	+240°C
48-Pin TQFP-EP (derate 30.4mW/°C above +70°C)	2430mW		

Stresses beyond those listed under "Absolute Maximum Ratings" may cause permanent damage to the device. These are stress ratings only, and functional operation of the device at these or any other conditions beyond those indicated in the operational sections of the specifications is not implied. Exposure to absolute maximum rating conditions for extended periods may affect device reliability.

ELECTRICAL CHARACTERISTICS

(V_{DD} = 3V, OV_{DD} = 2.5V, 0.1μF and 1μF capacitors from REFP, REFN, and COM to GND; REFOUT connected to REFIN through a 10kΩ resistor, V_{IN} = 2Vp-p (differential w.r.t. COM), C_L = 10pF at digital outputs (Note 1), f_{CLK} = 20MHz, T_A = T_{MIN} to T_{MAX}, unless otherwise noted. Typical values are at T_A = +25°C.) (Note 2)

PARAMETER	SYMBOL	CONDITIONS	MIN	TYP	MAX	UNITS
DC ACCURACY						
Resolution			10			Bits
Integral Nonlinearity	INL	f _{IN} = 7.5MHz		±0.5	±1.5	LSB
Differential Nonlinearity	DNL	f _{IN} = 7.5MHz, no missing codes guaranteed		±0.25	±1.0	LSB
Offset Error				< ±1	±1.9	% FS
Gain Error				0	±2	% FS
ANALOG INPUT						
Differential Input Voltage Range	V _{DIFF}	Differential or single-ended inputs		±1.0		V
Common-Mode Input Voltage Range	V _{CM}			V _{DD} /2 ± 0.5		V
Input Resistance	R _{IN}	Switched capacitor load		100		kΩ
Input Capacitance	C _{IN}			5		pF
CONVERSION RATE						
Maximum Clock Frequency	f _{CLK}		20			MHz
Data Latency		CHA		5		Clock cycles
		CHB		5.5		
DYNAMIC CHARACTERISTICS						
Signal-to-Noise Ratio (Note 3)	SNR	f _{INA} or B = 7.5MHz, T _A = +25°C	57.3	59.5		dB
		f _{INA} or B = 12MHz		59.4		
Signal-to-Noise and Distortion (Note 3)	SINAD	f _{INA} or B = 7.5MHz, T _A = +25°C	57	59.4		dB
		f _{INA} or B = 12MHz		59.2		
Spurious-Free Dynamic Range (Note 3)	SFDR	f _{INA} or B = 7.5MHz, T _A = +25°C	64	74		dBc
		f _{INA} or B = 12MHz		72		

Dual 10-Bit, 20Msps, 3V, Low-Power ADC with Internal Reference and Multiplexed Parallel Outputs

ELECTRICAL CHARACTERISTICS (continued)

($V_{DD} = 3V$, $OV_{DD} = 2.5V$, $0.1\mu F$ and $1\mu F$ capacitors from REFP, REFN, and COM to GND; REFOUT connected to REFIN through a $10k\Omega$ resistor, $V_{IN} = 2V_{p-p}$ (differential w.r.t. COM), $C_L = 10pF$ at digital outputs (Note 1), $f_{CLK} = 20MHz$, $T_A = T_{MIN}$ to T_{MAX} , unless otherwise noted. Typical values are at $T_A = +25^\circ C$.) (Note 2)

PARAMETER	SYMBOL	CONDITIONS	MIN	TYP	MAX	UNITS
Total Harmonic Distortion (First 4 Harmonics) (Note 3)	THD	f_{INA} or B = 7.5MHz, $T_A = +25^\circ C$		-72	-64	dBc
		f_{INA} or B = 12MHz		-71		
Third-Harmonic Distortion (Note 3)	HD3	f_{INA} or B = 7.5MHz		-74		dBc
		f_{INA} or B = 12MHz		-72		
Intermodulation Distortion	IMD	f_{INA} or B = 11.9852MHz at -6.5dBFS, f_{INA} or B = 12.8934MHz at -6.5dBFS (Note 4)		-76		dBc
Small-Signal Bandwidth		Input at -20dBFS, differential inputs		500		MHz
Full-Power Bandwidth	FPBW	Input at -0.5dBFS, differential inputs		400		MHz
Aperture Delay	t_{AD}			1		ns
Aperture Jitter	t_{AJ}			2		psRMS
Overdrive Recovery Time		For 1.5x full-scale input		2		ns
Differential Gain				± 1		%
Differential Phase				± 0.25		Degrees
Output Noise		$INA+ = INA- = INB+ = INB- = COM$		0.2		LSBRMS
INTERNAL REFERENCE						
Reference Output Voltage	REFOUT			2.048 $\pm 3\%$		V
Reference Temperature Coefficient	TC_{REF}			60		ppm/ $^\circ C$
Load Regulation				1.25		mV/mA
BUFFERED EXTERNAL REFERENCE ($V_{REFIN} = 2.048V$)						
REFIN Input Voltage	V_{REFIN}			2.048		V
Positive Reference Output Voltage	V_{REFP}			2.012		V
Negative Reference Output Voltage	V_{REFN}			0.988		V
Differential Reference Output Voltage Range	ΔV_{REF}	$\Delta V_{REF} = V_{REFP} - V_{REFN}$	0.95	1.024	1.10	V
REFIN Resistance	R_{REFIN}			> 50		$M\Omega$

Dual 10-Bit, 20MSPS, 3V, Low-Power ADC with Internal Reference and Multiplexed Parallel Outputs

ELECTRICAL CHARACTERISTICS (continued)

($V_{DD} = 3V$, $OV_{DD} = 2.5V$, $0.1\mu F$ and $1\mu F$ capacitors from REFP, REFN, and COM to GND; REFOUT connected to REFIN through a $10k\Omega$ resistor, $V_{IN} = 2V_{p-p}$ (differential w.r.t. COM), $C_L = 10pF$ at digital outputs (Note 1), $f_{CLK} = 20MHz$, $T_A = T_{MIN}$ to T_{MAX} , unless otherwise noted. Typical values are at $T_A = +25^\circ C$.) (Note 2)

PARAMETER	SYMBOL	CONDITIONS	MIN	TYP	MAX	UNITS
Maximum REFP, COM Source Current	I_{SOURCE}			5		mA
Maximum REFP, COM Sink Current	I_{SINK}			-250		μA
Maximum REFN Source Current	I_{SOURCE}			250		μA
Maximum REFN Sink Current	I_{SINK}			-5		mA
UNBUFFERED EXTERNAL REFERENCE ($V_{REFIN} = AGND$, reference voltage applied to REFP, REFN, and COM)						
REFP, REFN Input Resistance	R_{REFP}, R_{REFN}	Measured between REFP and COM, and REFN and COM		4		$k\Omega$
Differential Reference Input Voltage	ΔV_{REF}	$\Delta V_{REF} = V_{REFP} - V_{REFN}$		1.024 $\pm 10\%$		V
COM Input Voltage	V_{COM}			$V_{DD}/2$ $\pm 10\%$		V
REFP Input Voltage	V_{REFP}			$V_{COM} + \Delta V_{REF}/2$		V
REFN Input Voltage	V_{REFN}			$V_{COM} - \Delta V_{REF}/2$		V
DIGITAL INPUTS (CLK, PD, \overline{OE}, SLEEP, T/B)						
Input High Threshold	V_{IH}	CLK		0.8 $\times V_{DD}$		V
		PD, \overline{OE} , SLEEP, T/B		0.8 $\times OV_{DD}$		
Input Low Threshold	V_{IL}	CLK			0.2 $\times V_{DD}$	V
		PD, \overline{OE} , SLEEP, T/B				
Input Hysteresis	V_{HYST}			0.1		V
Input Leakage	I_{IH}	$V_{IH} = OV_{DD}$ or V_{DD} (CLK)			± 5	μA
	I_{IL}	$V_{IL} = 0$			± 5	
Input Capacitance	C_{IN}			5		pF
DIGITAL OUTPUTS (D0A/B–D9A/B, A/B)						
Output-Voltage Low	V_{OL}	$I_{SINK} = -200\mu A$			0.2	V
Output-Voltage High	V_{OH}	$I_{SOURCE} = 200\mu A$		$OV_{DD} - 0.2$		V
Three-State Leakage Current	I_{LEAK}	$\overline{OE} = OV_{DD}$			± 10	μA
Three-State Output Capacitance	C_{OUT}	$\overline{OE} = OV_{DD}$		5		pF

Dual 10-Bit, 20Msps, 3V, Low-Power ADC with Internal Reference and Multiplexed Parallel Outputs

ELECTRICAL CHARACTERISTICS (continued)

($V_{DD} = 3V$, $OV_{DD} = 2.5V$, $0.1\mu F$ and $1\mu F$ capacitors from REFP, REFN, and COM to GND; REFOUT connected to REFIN through a $10k\Omega$ resistor, $V_{IN} = 2V_{p-p}$ (differential w.r.t. COM), $C_L = 10pF$ at digital outputs (Note 1), $f_{CLK} = 20MHz$, $T_A = T_{MIN}$ to T_{MAX} , unless otherwise noted. Typical values are at $T_A = +25^\circ C$.) (Note 2)

PARAMETER	SYMBOL	CONDITIONS	MIN	TYP	MAX	UNITS
POWER REQUIREMENTS						
Analog Supply Voltage Range	V_{DD}		2.7	3.0	3.6	V
Output Supply Voltage Range	OV_{DD}		1.7	2.5	3.6	V
Analog Supply Current	I_{VDD}	Operating, f_{INA} or $B = 7.5MHz$ at $-0.5dBFS$		35	50	mA
		Sleep mode		2.8		
		Shutdown, clock idle, $PD = \overline{OE} = OV_{DD}$		1	15	μA
Output Supply Current	I_{OVDD}	Operating, $C_L = 15pF$, f_{INA} or $B = 7.5MHz$ at $-0.5dBFS$		9		mA
		Sleep mode		100		
		Shutdown, clock idle, $PD = \overline{OE} = OV_{DD}$		2	10	μA
Power Dissipation	PDISS	Operating, f_{INA} or $B = 7.5MHz$ at $-0.5dBFS$		105	150	mW
		Sleep mode		8.4		
		Shutdown, clock idle, $PD = \overline{OE} = OV_{DD}$		3	45	μW
Power-Supply Rejection Ratio	PSRR	Offset		± 0.2		mV/V
		Gain		± 0.1		%/V
TIMING CHARACTERISTICS						
CLK Rise to CHA Output Data Valid	t_{DOA}	Figure 3 (Note 5)		5	8	ns
CLK Fall to CHB Output Data Valid	t_{DOB}	Figure 3 (Note 5)		5	8	ns
Clock Rise/Fall to A/B Rise/Fall Time	$t_{DA/B}$			6		ns
Output Enable Time	t_{ENABLE}	Figure 4		10		ns
Output Disable Time	$t_{DISABLE}$	Figure 4		1.5		ns
CLK Pulse Width High	t_{CH}	Figure 3, clock period: 50ns		25 ± 7.5		ns
CLK Pulse Width Low	t_{CL}	Figure 3, clock period: 50ns		25 ± 7.5		ns
Wake-Up Time	t_{WAKE}	Wake-up from sleep mode (Note 6)		0.51		μs
		Wake-up from shutdown (Note 6)		1.5		
CHANNEL-TO-CHANNEL MATCHING						
Crosstalk		f_{INA} or $B = 7.5MHz$ at $-0.5dBFS$		-70		dB
Gain Matching		f_{INA} or $B = 7.5MHz$ at $-0.5dBFS$		0.02	± 0.2	dB
Phase Matching		f_{INA} or $B = 7.5MHz$ at $-0.5dBFS$		0.25		Degrees

Note 1: Equivalent dynamic performance is obtainable over full OV_{DD} range with reduced C_L .

Note 2: Specifications at $\geq +25^\circ C$ are guaranteed by production test and $< +25^\circ C$ are guaranteed by design and characterization.

Note 3: SNR, SINAD, THD, SFDR, and HD3 are based on an analog input voltage of $-0.5dBFS$ referenced to a $\pm 1.024V$ full-scale input voltage range.

Note 4: Intermodulation distortion is the total power of the intermodulation products relative to the individual carrier. This number is 6dB or better, if referenced to the two-tone envelope.

Note 5: Digital outputs settle to V_{IH} , V_{IL} . Parameter guaranteed by design.

Note 6: With REFIN driven externally, REFP, COM, and REFN are left unconnected while powered down.

Dual 10-Bit, 20MSPS, 3V, Low-Power ADC with Internal Reference and Multiplexed Parallel Outputs

Typical Operating Characteristics

($V_{DD} = 3V$, $OV_{DD} = 2.5V$, $V_{REFIN} = 2.048V$, differential input at $-0.5dBFS$, $f_{CLK} = 20MHz$, $C_L \approx 10pF$, $T_A = +25^\circ C$, unless otherwise noted.)

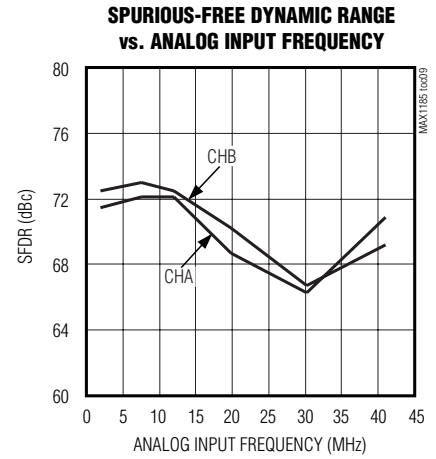
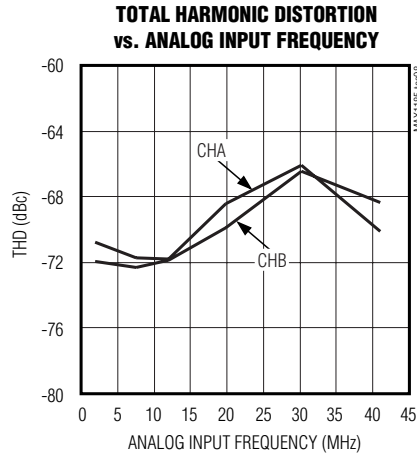
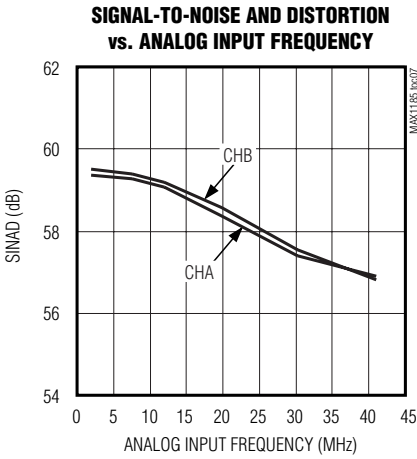
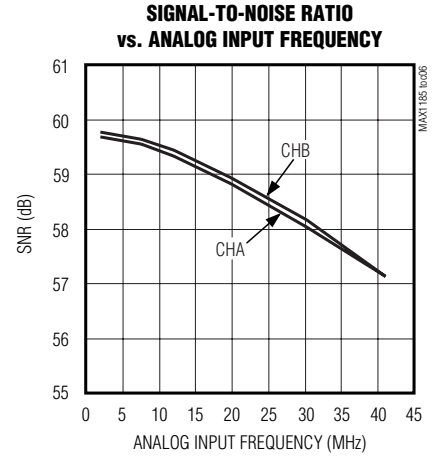
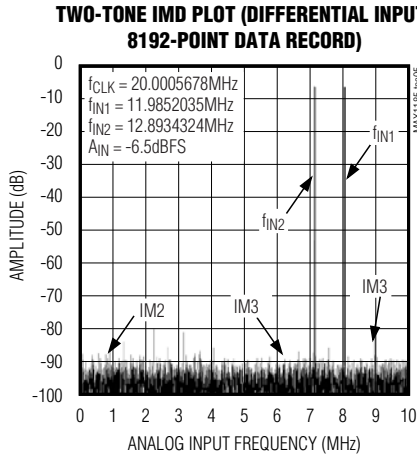
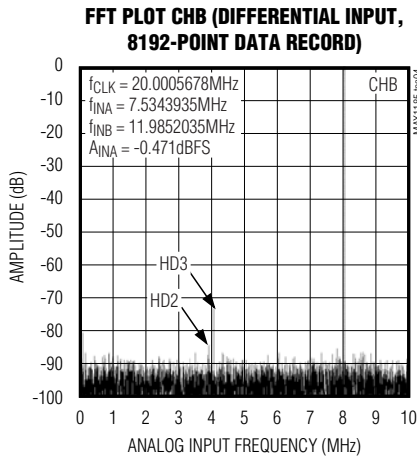
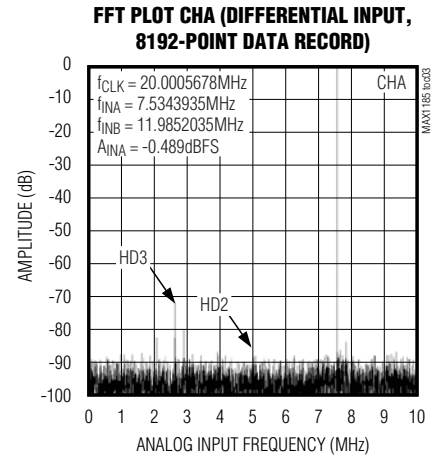
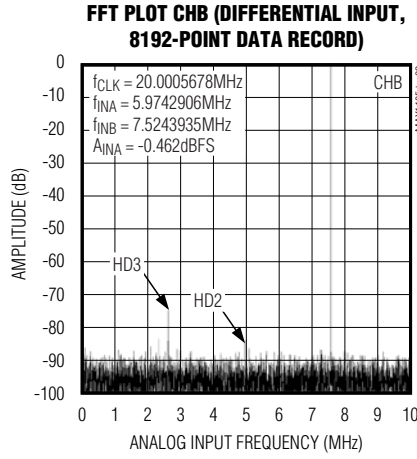
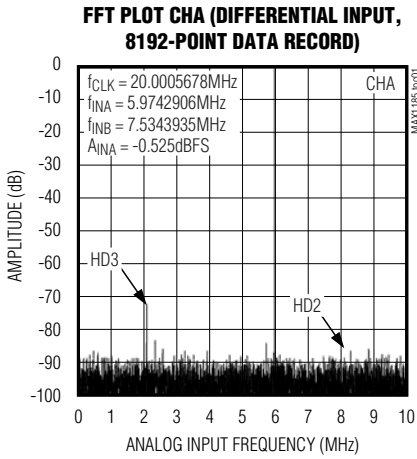

Dual 10-Bit, 20MSPS, 3V, Low-Power ADC with Internal Reference and Multiplexed Parallel Outputs

Typical Operating Characteristics (continued)

($V_{DD} = 3V$, $OV_{DD} = 2.5V$, $V_{REFIN} = 2.048V$, differential input at -0.5dBFS , $f_{CLK} = 20\text{MHz}$, $C_L \approx 10\text{pF}$, $T_A = +25^\circ\text{C}$, unless otherwise noted)

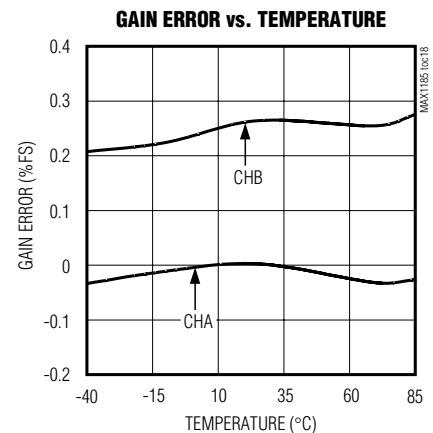
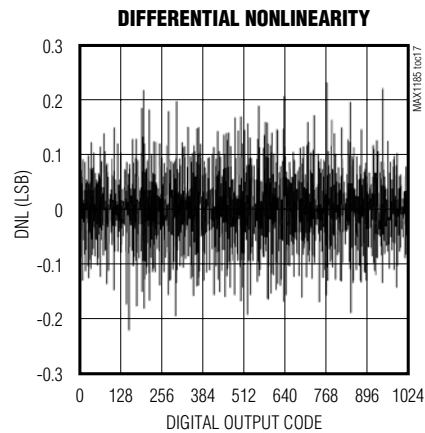
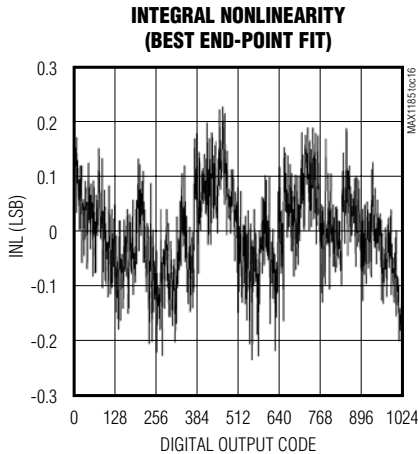
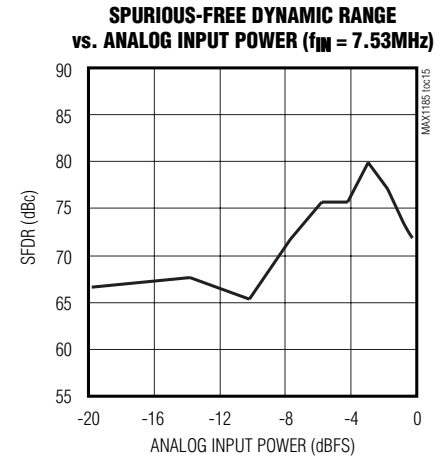
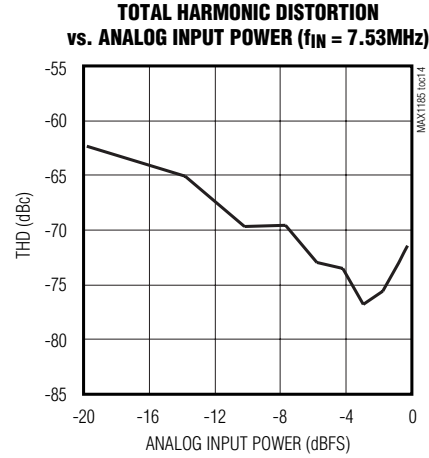
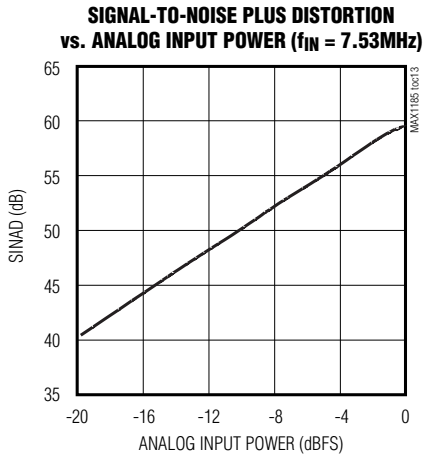
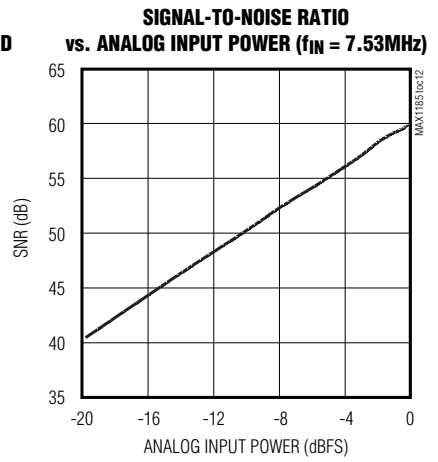
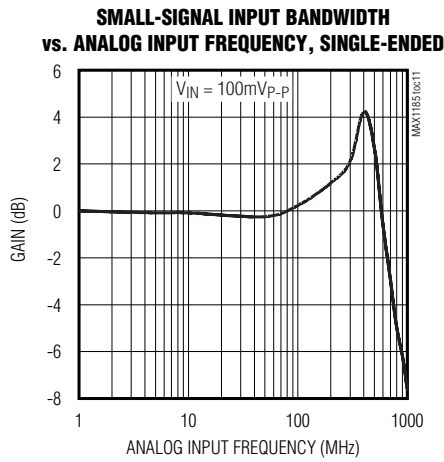
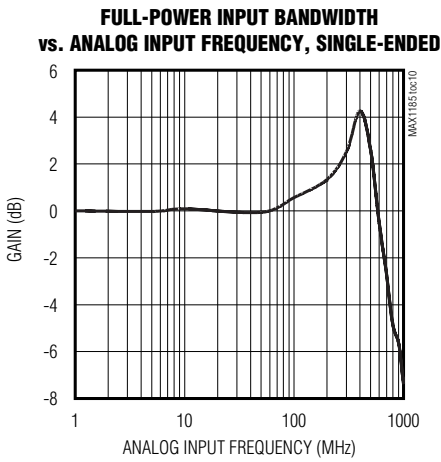

Dual 10-Bit, 20MSPS, 3V, Low-Power ADC with Internal Reference and Multiplexed Parallel Outputs

Typical Operating Characteristics (continued)

($V_{DD} = 3V$, $OV_{DD} = 2.5V$, $V_{REFIN} = 2.048V$, differential input at $-0.5dBFS$, $f_{CLK} = 20MHz$, $C_L \approx 10pF$, $T_A = +25^\circ C$, unless otherwise noted.)

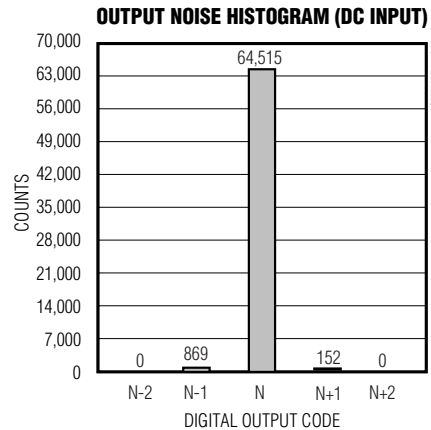
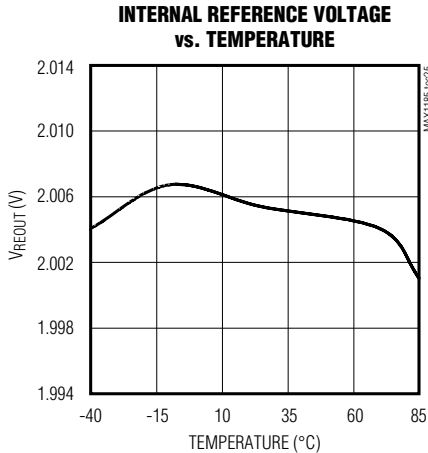
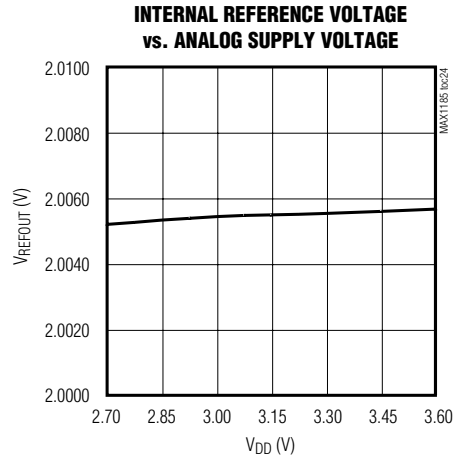
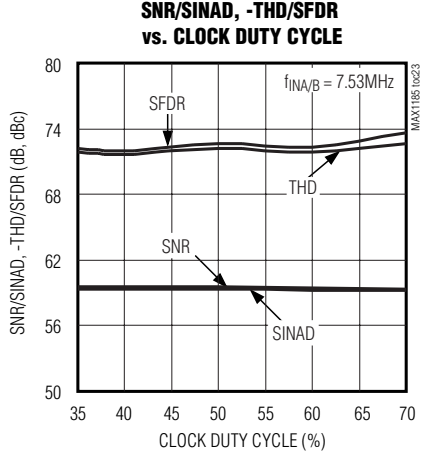
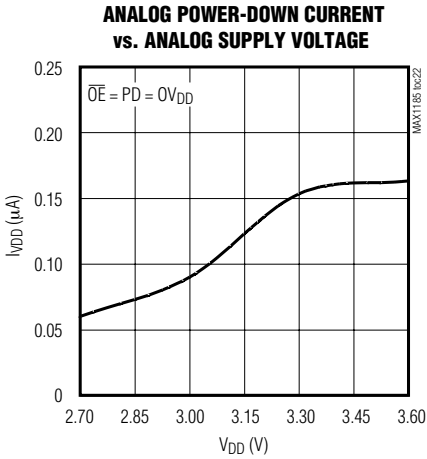
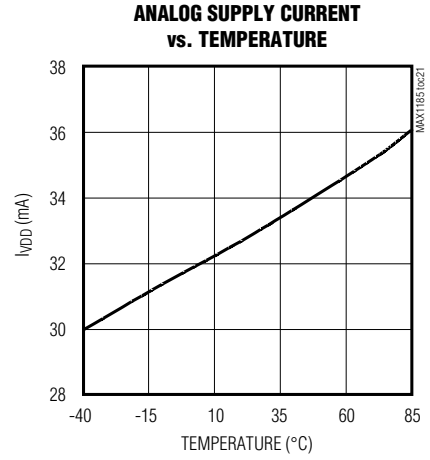
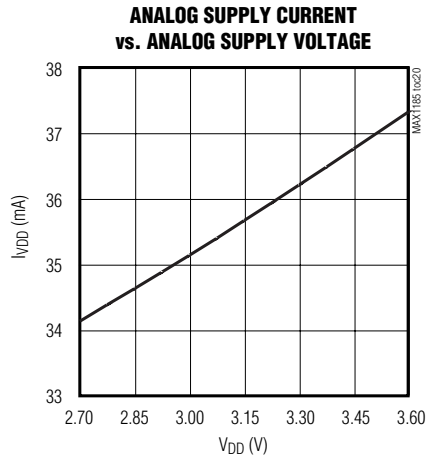
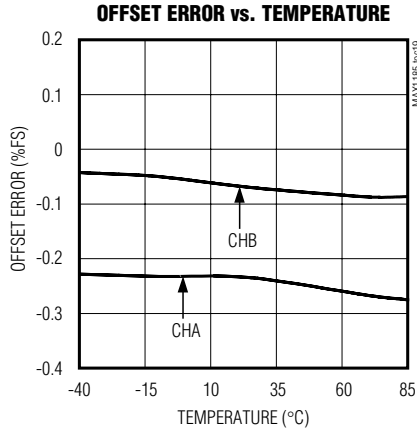

Dual 10-Bit, 20Msps, 3V, Low-Power ADC with Internal Reference and Multiplexed Parallel Outputs

Pin Description

PIN	NAME	FUNCTION
1	COM	Common-Mode Voltage Input/Output. Bypass to GND with a $\geq 0.1\mu\text{F}$ capacitor.
2, 6, 11, 14, 15	V _{DD}	Analog Supply Voltage. Bypass each supply pin to GND with a $0.1\mu\text{F}$ capacitor. Analog supply accepts a 2.7V to 3.6V input range.
3, 7, 10, 13, 16	GND	Analog Ground
4	INA+	Channel A Positive Analog Input. For single-ended operation, connect signal source to INA+.
5	INA-	Channel A Negative Analog Input. For single-ended operation, connect INA- to COM.
8	INB-	Channel B Negative Analog Input. For single-ended operation, connect INB- to COM.
9	INB+	Channel B Positive Analog Input. For single-ended operation, connect signal source to INB+.
12	CLK	Converter Clock Input
17	T/B	T/B selects the ADC digital output format. High: Two's complement. Low: Straight offset binary.
18	SLEEP	Sleep Mode Input. High: Deactivates the two ADCs, but leaves the reference bias circuit active. Low: Normal operation.
19	PD	Power-Down Input. High: Power-down mode. Low: Normal operation.
20	$\overline{\text{OE}}$	Output Enable Input. High: Digital outputs disabled. Low: Digital outputs enabled.
21–29	N.C.	Do not connect.
30	A/B	A/B Data Indicator. This digital output indicates CHA data (A/B = 1) or CHB data (A/B = 0) to be present on the output. A/B follows the external clock signal with typically 6ns delay.
31, 34	OGND	Output Driver Ground
32, 33	OV _{DD}	Output Driver Supply Voltage. Bypass each supply pin to OGND with a $0.1\mu\text{F}$ capacitor. Output driver supply accepts a 1.7V to 3.6V input range.
35	D0A/B	Three-State Digital Output, Bit 0 (LSB). Depending on status of A/B, output data reflects channel A or channel B data.
36	D1A/B	Three-State Digital Output, Bit 1. Depending on status of A/B, output data reflects channel A or channel B data.
37	D2A/B	Three-State Digital Output, Bit 2. Depending on status of A/B, output data reflects channel A or channel B data.
38	D3A/B	Three-State Digital Output, Bit 3. Depending on status of A/B, output data reflects channel A or channel B data.
39	D4A/B	Three-State Digital Output, Bit 4. Depending on status of A/B, output data reflects channel A or channel B data.
40	D5A/B	Three-State Digital Output, Bit 5. Depending on status of A/B, output data reflects channel A or channel B data.

MAX1185

Dual 10-Bit, 20MSPS, 3V, Low-Power ADC with Internal Reference and Multiplexed Parallel Outputs

Pin Description (continued)

PIN	NAME	FUNCTION
41	D6A/B	Three-State Digital Output, Bit 6. Depending on status of A/B, output data reflects channel A or channel B data.
42	D7A/B	Three-State Digital Output, Bit 7. Depending on status of A/B, output data reflects channel A or channel B data.
43	D8A/B	Three-State Digital Output, Bit 8. Depending on status of A/B, output data reflects channel A or channel B data.
44	D9A/B	Three-State Digital Output, Bit 9 (MSB). Depending on status of A/B, output data reflects channel A or channel B data.
45	REFOUT	Internal Reference Voltage Output. May be connected to REFIN through a resistor or a resistor-divider.
46	REFIN	Reference Input. $V_{REFIN} = 2 \times (V_{REFP} - V_{REFN})$. Bypass to GND with a $> 1nF$ capacitor.
47	REFP	Positive Reference Input/Output. Conversion range is $\pm (V_{REFP} - V_{REFN})$. Bypass to GND with a $> 0.1\mu F$ capacitor.
48	REFN	Negative Reference Input/Output. Conversion range is $\pm (V_{REFP} - V_{REFN})$. Bypass to GND with a $> 0.1\mu F$ capacitor.
—	EP	Exposed Pad. Connect to analog ground.

Detailed Description

The MAX1185 uses a nine-stage, fully-differential, pipelined architecture (Figure 1) that allows for high-speed conversion while minimizing power consumption. Samples taken at the inputs move progressively through the pipeline stages every half-clock cycle. Including the delay through the output latch, the total clock-cycle latency is five clock cycles.

1.5-bit (2-comparator) flash ADCs convert the held input voltages into a digital code. The digital-to-analog converters (DACs) convert the digitized results back into analog voltages, which are then subtracted from the original held input signals. The resulting error signals are then multiplied by two and the residues are passed along to the next pipeline stages, where the process is repeated until the signals have been processed by all nine stages. Digital error correction compensates for ADC comparator offsets in each of these pipeline stages and ensures no missing codes.

Both input channels are sampled on the rising edge of the clock and the resulting data is multiplexed at the output. CHA data is updated on the rising edge (five clock cycles later) and CHB data is updated on the falling edge (5.5 clock cycles later) of the clock signal. The A/B indicator follows the clock signal with a typical delay time of 6ns and remains high when CHA data is updated and low when CHB data is updated.

Input Track-and-Hold (T/H) Circuits

Figure 2 displays a simplified functional diagram of the input track-and-hold (T/H) circuits in both track and hold mode. In track mode, switches S1, S2a, S2b, S4a, S4b, S5a, and S5b are closed. The fully differential circuits sample the input signals onto the two capacitors (C2a and C2b) through switches S4a and S4b. S2a and S2b set the common mode for the amplifier input, and open simultaneously with S1, sampling the input waveform. Switches S4a and S4b are then opened before switches S3a and S3b connect capacitors C1a and C1b to the output of the amplifier and switch S4c is closed. The resulting differential voltages are held on capacitors C2a and C2b. The amplifiers are used to charge capacitors C1a and C1b to the same values originally held on C2a and C2b. These values are then presented to the first stage quantizers and isolate the pipelines from the fast-changing inputs. The wide input bandwidth T/H amplifiers allow the MAX1185 to track and sample/hold analog inputs of high frequencies ($> Nyquist$). Both ADC inputs (INA+, INB+, INA-, and INB-) can be driven either differentially or single-ended. Match the impedance of INA+ and INA- as well as INB+ and INB- and set the common-mode voltage to midsupply ($V_{DD}/2$) for optimum performance.

Dual 10-Bit, 20MSPS, 3V, Low-Power ADC with Internal Reference and Multiplexed Parallel Outputs

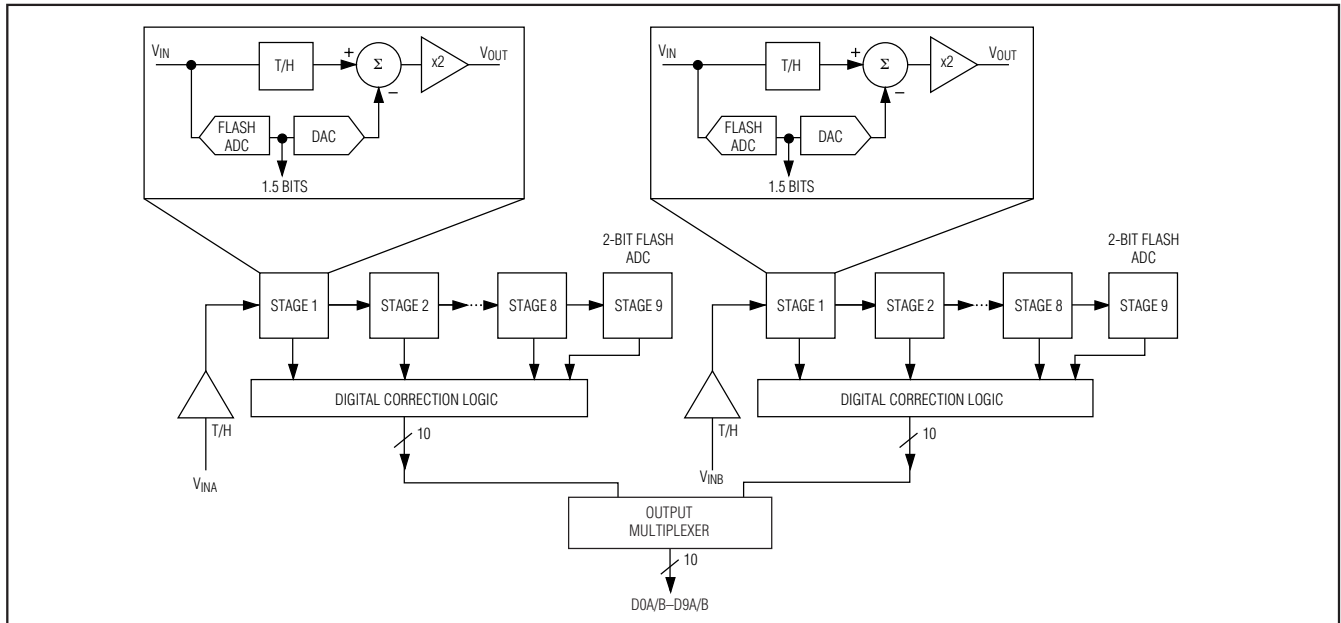

Figure 1. Pipelined Architecture—Stage Blocks

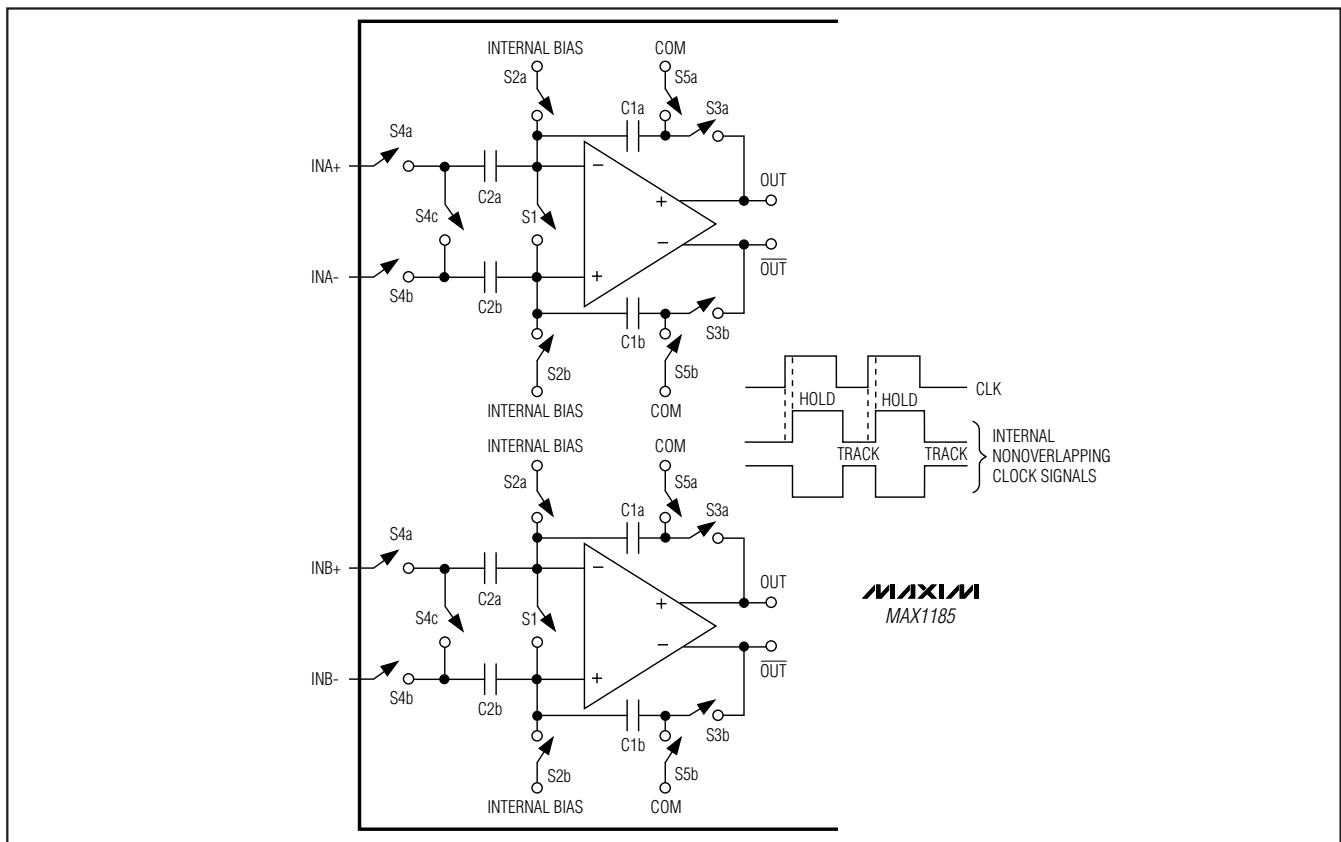

Figure 2. MAX1185 T/H Amplifiers

Dual 10-Bit, 20Msps, 3V, Low-Power ADC with Internal Reference and Multiplexed Parallel Outputs

Analog Inputs and Reference Configurations

The full-scale range of the MAX1185 is determined by the internally generated voltage difference between REFP ($V_{DD}/2 + V_{REFIN}/4$) and REFN ($V_{DD}/2 - V_{REFIN}/4$). The full-scale range for both on-chip ADCs is adjustable through the REFIN pin, which is provided for this purpose.

REFOUT, REFP, COM ($V_{DD}/2$), and REFN are internally buffered low-impedance outputs.

The MAX1185 provides three modes of reference operation:

- Internal reference mode
- Buffered external reference mode
- Unbuffered external reference mode

In internal reference mode, connect the internal reference output REFOUT to REFIN through a resistor (e.g., 10k Ω) or resistor-divider, if an application requires a reduced full-scale range. For stability and noise filtering purposes, bypass REFIN with a > 10nF capacitor to GND. In internal reference mode, REFOUT, COM, REFP, and REFN become low-impedance outputs.

In buffered external reference mode, adjust the reference voltage levels externally by applying a stable and accurate voltage at REFIN. In this mode, COM, REFP, and REFN become outputs. REFOUT may be left open or connected to REFIN through a > 10k Ω resistor.

In unbuffered external reference mode, connect REFIN to GND. This deactivates the on-chip reference buffers for REFP, COM, and REFN. With their buffers shut down, these nodes become high impedance and may be driven through separate, external reference sources.

Clock Input (CLK)

The MAX1185's CLK input accepts CMOS-compatible clock signals. Since the interstage conversion of the device depends on the repeatability of the rising and falling edges of the external clock, use a clock with low jitter and fast rise and fall times (< 2ns). In particular, sampling occurs on the rising edge of the clock signal, requiring this edge to provide lowest possible jitter. Any significant aperture jitter would limit the SNR performance of the on-chip ADCs as follows:

$$SNR_{dB} = 20 \times \log_{10} (1/[2\pi \times f_{IN} \times t_{AJ}])$$

where f_{IN} represents the analog input frequency and t_{AJ} is the time of the aperture jitter.

Clock jitter is especially critical for undersampling applications. The clock input should always be considered as an analog input and routed away from any analog input or other digital signal lines.

The MAX1185 clock input operates with a voltage threshold set to $V_{DD}/2$. Clock inputs with a duty cycle other than 50%, must meet the specifications for high and low periods as stated in the *Electrical Characteristics*.

System Timing Requirements

Figure 3 shows the relationship between clock and analog input, A/B indicator, and the resulting CHA/CHB data output. CHA and CHB data are sampled on the rising edge of the clock signal. Following the rising edge of the 5th clock cycles, the digitized value of the original CHA sample is presented at the output, followed one half-clock cycle later by the digitized value of the original CHB sample.

A channel selection signal (A/B indicator) allows the user to determine which output data represents which input channel. With A/B = 1, digitized data from CHA is present at the output and with A/B = 0 digitized data from CHB is present.

Digital Output Data, Output Data Format Selection (T/B), Output Enable (OE), Channel Selection (A/B)

All digital outputs, D0A/B–D9A/B (CHA or CHB data) and A/B are TTL/CMOS logic-compatible. The output coding can be chosen to be either offset binary or two's complement (Table 1) controlled by a single pin (T/B). Pull T/B low to select offset binary and high to activate two's complement output coding. The capacitive load on the digital outputs D0A/B–D9A/B should be kept as low as possible (< 15pF), to avoid large digital currents that could feed back into the analog portion of the MAX1185, thereby degrading its dynamic performance. Using buffers on the digital outputs of the ADCs can further isolate the digital outputs from heavy capacitive loads. To further improve the dynamic performance of the MAX1185, small-series resistors (e.g., 100 Ω) may be added to the digital output paths close to the MAX1185.

Figure 4 displays the timing relationship between output enable and data output valid as well as power-down/wake-up and data output valid.

Power-Down (PD) and Sleep (SLEEP) Modes

The MAX1185 offers two power-save modes—sleep and full power-down mode. In sleep mode (SLEEP = 1), only the reference bias circuit is active (both ADCs are disabled), and current consumption is reduced to 2.8mA.

To enter full power-down mode, pull PD high. With \overline{OE} simultaneously low, all outputs are latched at the last value prior to the power-down. Pulling \overline{OE} high forces the digital outputs into a high-impedance state.

Dual 10-Bit, 20Msps, 3V, Low-Power ADC with Internal Reference and Multiplexed Parallel Outputs

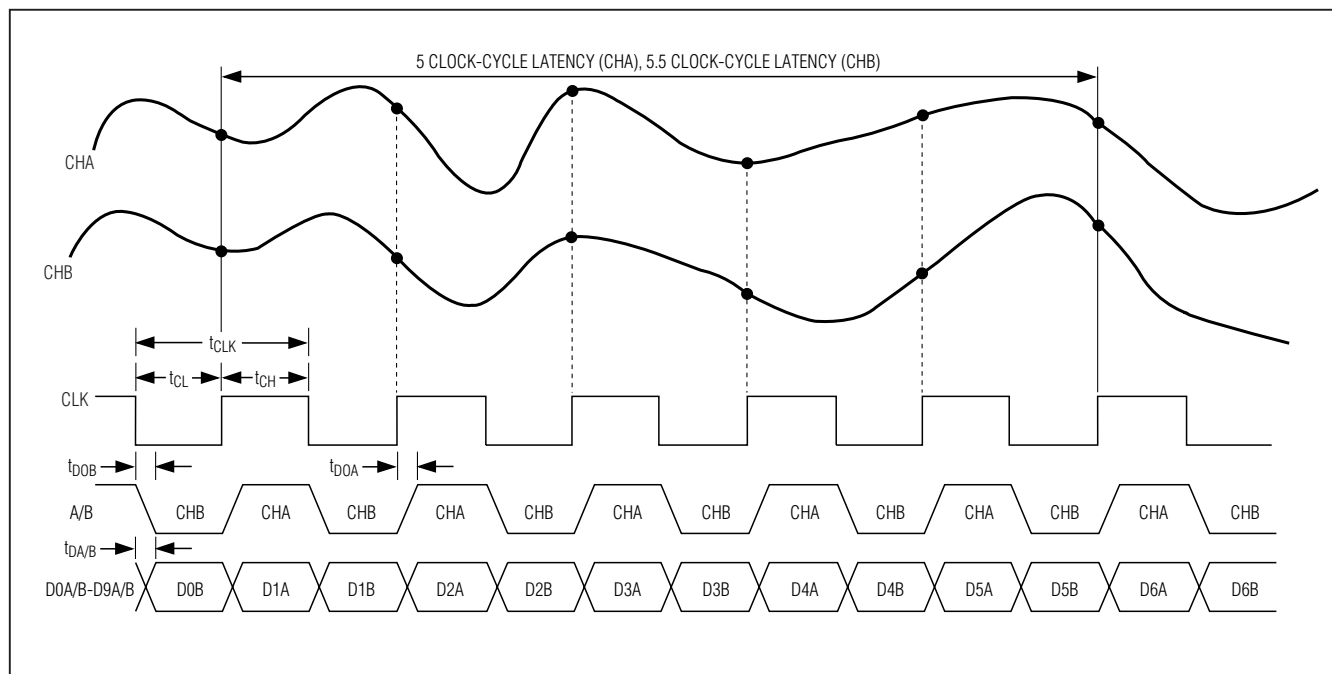

Figure 3. Timing Diagram for Multiplexed Outputs

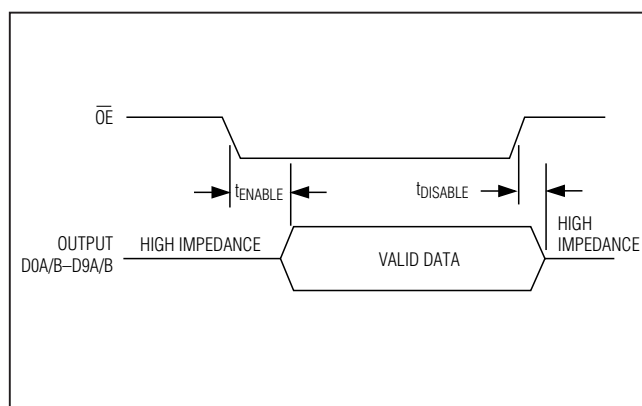

Figure 4. Output Timing Diagram

Applications Information

Figure 5 depicts a typical application circuit containing two single-ended to differential converters. The internal reference provides a $V_{DD}/2$ output voltage for level shifting purposes. The input is buffered and then split to a voltage follower and inverter. One lowpass filter per ADC suppresses some of the wideband noise associated with high-speed operational amplifiers that follows

the amplifiers. The user may select the R_{ISO} and C_{IN} values to optimize the filter performance, to suit a particular application. For the application in Figure 5, a R_{ISO} of 50Ω is placed before the capacitive load to prevent ringing and oscillation. The 22pF C_{IN} capacitor acts as a small bypassing capacitor.

Using Transformer Coupling

An RF transformer (Figure 6) provides an excellent solution to convert a single-ended source signal to a fully differential signal, required by the MAX1185 for optimum performance. Connecting the center tap of the transformer to COM provides a $V_{DD}/2$ DC level shift to the input. Although a 1:1 transformer is shown, a step-up transformer may be selected to reduce the drive requirements. A reduced signal swing from the input driver, such as an op amp, may also improve the overall distortion.

In general, the MAX1185 provides better SFDR and THD with fully differential input signals than single-ended drive, especially for very high input frequencies. In differential input mode, even-order harmonics are lower as both inputs (INA+, INA- and/or INB+, INB-) are balanced, and each of the ADC inputs only requires half the signal swing compared to single-ended mode.

Dual 10-Bit, 20MSPS, 3V, Low-Power ADC with Internal Reference and Multiplexed Parallel Outputs

Table 1. MAX1185 Output Codes For Differential Inputs

DIFFERENTIAL INPUT VOLTAGE*	DIFFERENTIAL INPUT	STRAIGHT OFFSET BINARY T/B = 0	TWO'S COMPLEMENT T/B = 1
$V_{REF} \times 511/512$	+FULL SCALE - 1LSB	11 1111 1111	01 1111 1111
$V_{REF} \times 1/512$	+ 1 LSB	10 0000 0001	00 0000 0001
0	Bipolar Zero	10 0000 0000	00 0000 0000
$-V_{REF} \times 1/512$	- 1 LSB	01 1111 1111	11 1111 1111
$-V_{REF} \times 511/512$	- FULL SCALE + 1 LSB	00 0000 0001	10 0000 0001
$-V_{REF} \times 512/512$	- FULL SCALE	00 0000 0000	10 0000 0000

* $V_{REF} = V_{REFP} - V_{REFN}$

Single-Ended AC-Coupled Input Signal

Figure 7 shows an AC-coupled, single-ended application. Amplifiers like the MAX4108 provide high speed, high bandwidth, low noise, and low distortion to maintain the integrity of the input signal.

Typical QAM Demodulation Application

The most frequently used modulation technique for digital communications applications is probably the Quadrature Amplitude Modulation (QAM). Typically found in spread-spectrum based systems, a QAM signal represents a carrier frequency modulated in both amplitude and phase. At the transmitter, modulating the baseband signal with quadrature outputs, a local oscillator followed by subsequent up-conversion can generate the QAM signal. The result is an in-phase (I) and a quadrature (Q) carrier component, where the Q component is 90 degree phase-shifted with respect to the in-phase component. At the receiver, the QAM signal is divided down into its I and Q components, essentially representing the modulation process reversed. Figure 8 displays the demodulation process performed in the analog domain, using the dual matched 3.3V, 10-bit ADC MAX1185 and the MAX2451 quadrature demodulator to recover and digitize the I and Q baseband signals. Before being digitized by the MAX1185, the mixed down-signal components may be filtered by matched analog filters, such as Nyquist or Pulse-Shaping filters. These remove any unwanted images from the mixing process, thereby enhancing the overall signal-to-noise (SNR) performance and minimizing intersymbol interference.

Grounding, Bypassing, and Board Layout

The MAX1185 requires high-speed board layout design techniques. Locate all bypass capacitors as close as possible to the device, preferably on the same side as the ADC, using surface-mount devices for minimum inductance. Bypass V_{DD} , $REFP$, $REFN$, and COM with two parallel 0.1 μ F ceramic capacitors and a 2.2 μ F bipolar capacitor to GND. Follow the same rules to bypass the digital supply (OV_{DD}) to $OGND$. Multilayer boards with separated ground and power planes produce the highest level of signal integrity. Consider the use of a split ground plane arranged to match the physical location of the analog ground (GND) and the digital output driver ground ($OGND$) on the ADC's package. The two ground planes should be joined at a single point such that the noisy digital ground currents do not interfere with the analog ground plane. The ideal location of this connection can be determined experimentally at a point along the gap between the two ground planes, which produces optimum results. Make this connection with a low-value, surface-mount resistor (1 Ω to 5 Ω), a ferrite bead, or a direct short. Alternatively, all ground pins could share the same ground plane, if the ground plane is sufficiently isolated from any noisy digital systems ground plane (e.g., downstream output buffer or DSP ground plane). Route high-speed digital signal traces away from the sensitive analog traces of either channel. Make sure to isolate the analog input lines to each respective converter to minimize channel-to-channel crosstalk. Keep all signal lines short and free of 90 degree turns.

Dual 10-Bit, 20MSPS, 3V, Low-Power ADC with Internal Reference and Multiplexed Parallel Outputs

MAX1185

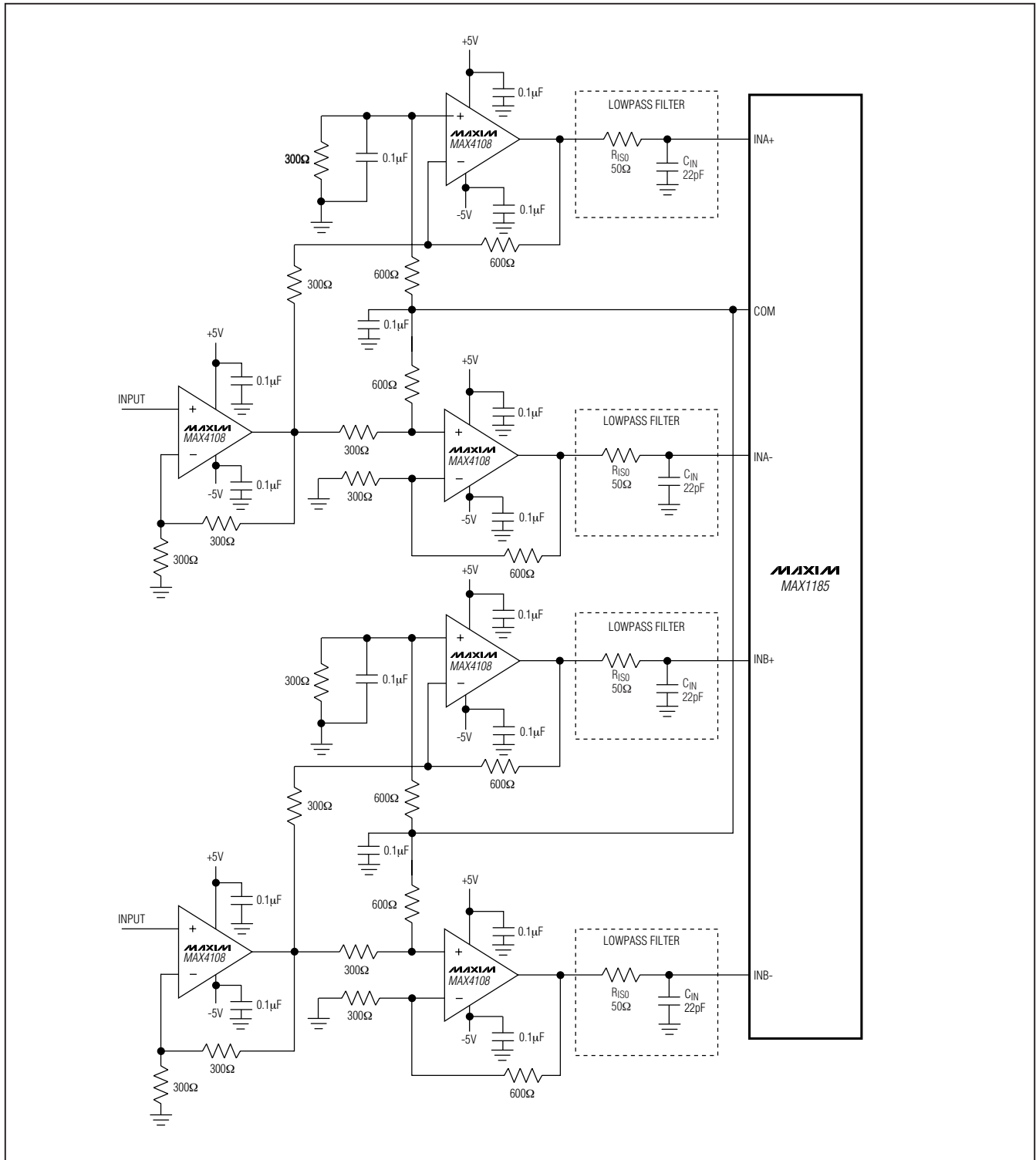

Figure 5. Typical Application for Single-Ended-to-Differential Conversion

Dual 10-Bit, 20MSPS, 3V, Low-Power ADC with Internal Reference and Multiplexed Parallel Outputs

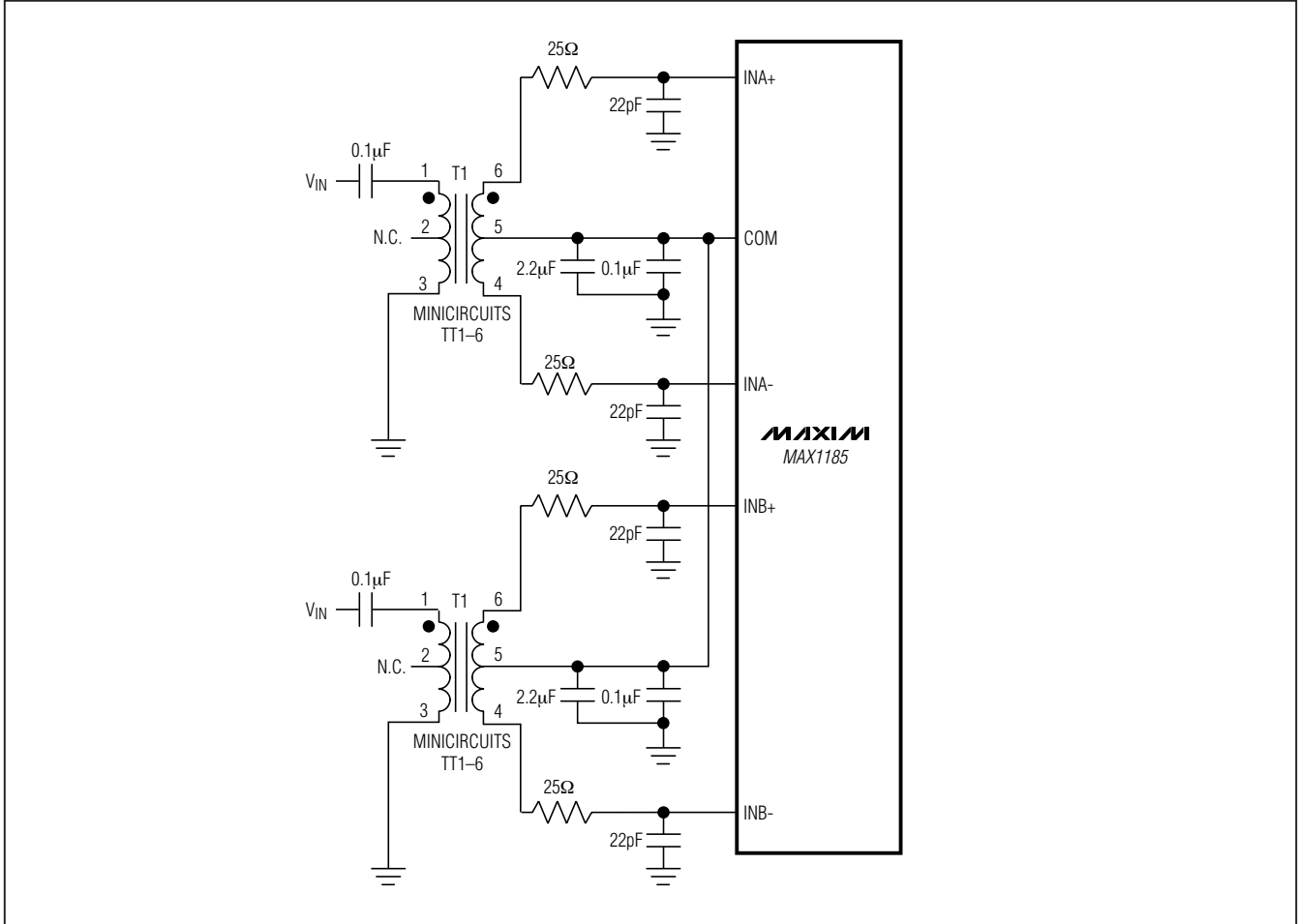

Figure 6. Transformer-Coupled Input Drive

Static Parameter Definitions

Integral Nonlinearity (INL)

Integral nonlinearity is the deviation of the values on an actual transfer function from a straight line. This straight line can be either a best straight-line fit or a line drawn between the endpoints of the transfer function, once offset and gain errors have been nullified. The static linearity parameters for the MAX1185 are measured using the best straight-line fit method.

Differential Nonlinearity (DNL)

Differential nonlinearity is the difference between an actual step width and the ideal value of 1 LSB. A DNL error specification of less than 1 LSB guarantees no missing codes and a monotonic transfer function.

Dynamic Parameter Definitions

Aperture Jitter

Figure 9 depicts the aperture jitter (t_{AJ}), which is the sample-to-sample variation in the aperture delay.

Aperture Delay

Aperture delay (t_{AD}) is the time defined between the falling edge of the sampling clock and the instant when an actual sample is taken (Figure 9).

Signal-to-Noise Ratio (SNR)

For a waveform perfectly reconstructed from digital samples, the theoretical maximum SNR is the ratio of the full-scale analog input (RMS value) to the RMS

Dual 10-Bit, 20Msps, 3V, Low-Power ADC with Internal Reference and Multiplexed Parallel Outputs

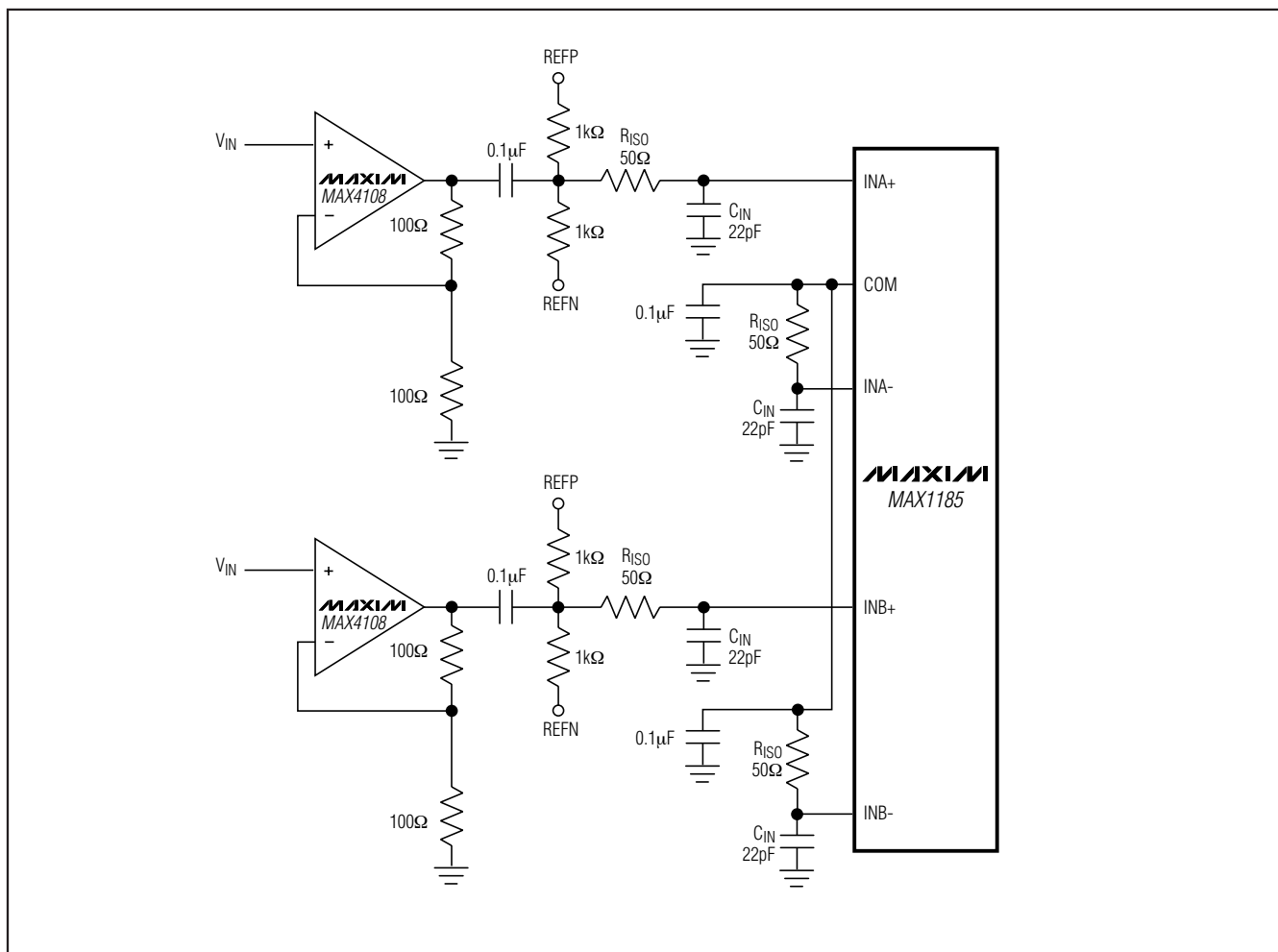

Figure 7. Using an Op Amp for Single-Ended, AC-Coupled Input Drive

quantization error (residual error). The ideal, theoretical minimum analog-to-digital noise is caused by quantization error only and results directly from the ADC's resolution (N-Bits):

$$\text{SNR}_{\text{dB}[\text{max}]} = 6.02 \times N + 1.76$$

In reality, there are other noise sources besides quantization noise: thermal noise, reference noise, clock jitter, etc. SNR is computed by taking the ratio of the RMS

signal to the RMS noise, which includes all spectral components minus the fundamental, the first five harmonics, and the DC offset.

Signal-to-Noise Plus Distortion (SINAD)

SINAD is computed by taking the ratio of the RMS signal to all spectral components minus the fundamental and the DC offset.

Dual 10-Bit, 20MSPS, 3V, Low-Power ADC with Internal Reference and Multiplexed Parallel Outputs

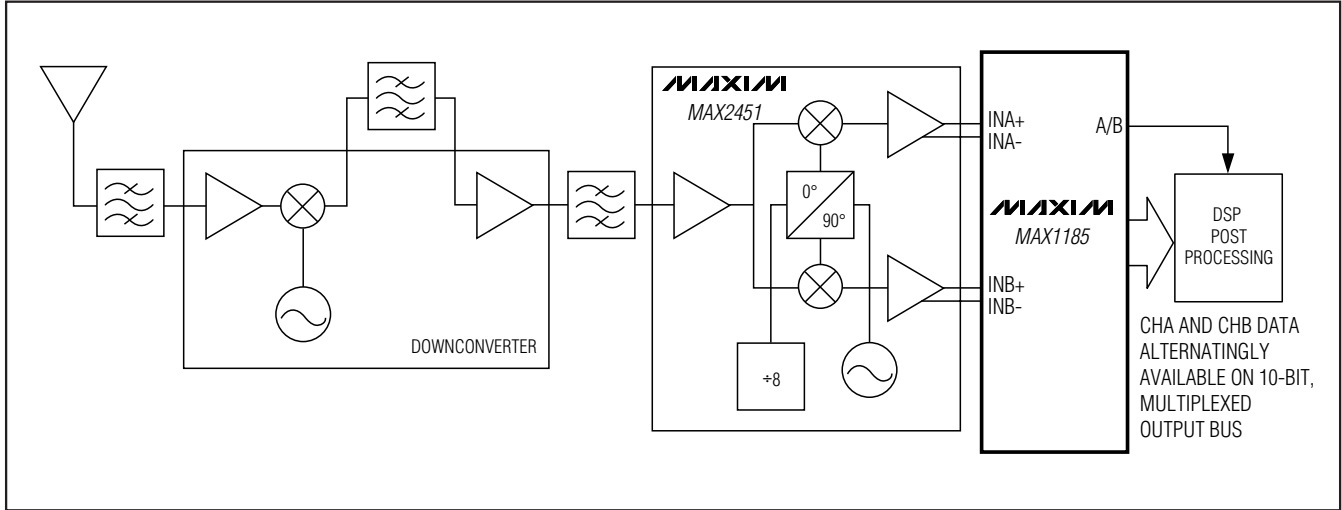

Figure 8. Typical QAM Application, Using the MAX1185

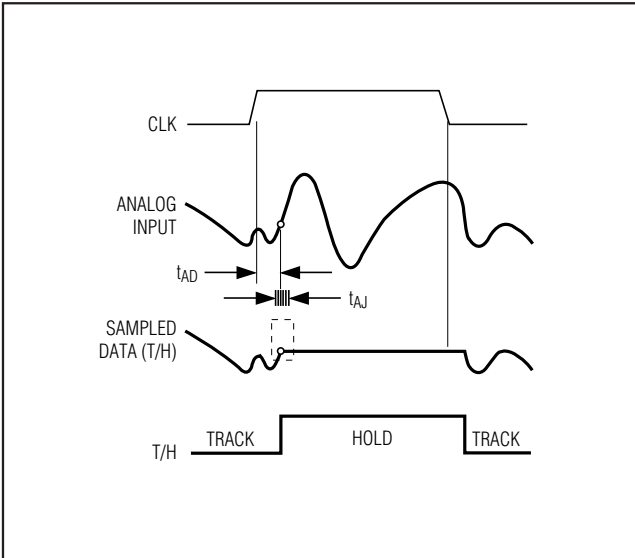

Figure 9. T/H Aperture Timing

Total Harmonic Distortion (THD)

THD is typically the ratio of the RMS sum of the first four harmonics of the input signal to the fundamental itself. This is expressed as:

$$THD = 20 \times \log_{10} \left(\frac{\sqrt{V_2^2 + V_3^2 + V_4^2 + V_5^2}}{V_1} \right)$$

where V_1 is the fundamental amplitude, and V_2 through V_5 are the amplitudes of the 2nd- through 5th-order harmonics.

Spurious-Free Dynamic Range (SFDR)

SFDR is the ratio expressed in decibels of the RMS amplitude of the fundamental (maximum signal component) to the RMS value of the next largest spurious component, excluding DC offset.

Intermodulation Distortion (IMD)

The two-tone IMD is the ratio expressed in decibels of either input tone to the worst 3rd-order (or higher) intermodulation products. The individual input tone levels are backed off by 6.5dB from full scale.

Dual 10-Bit, 20MSPS, 3V, Low-Power ADC with Internal Reference and Multiplexed Parallel Outputs

Functional Diagram

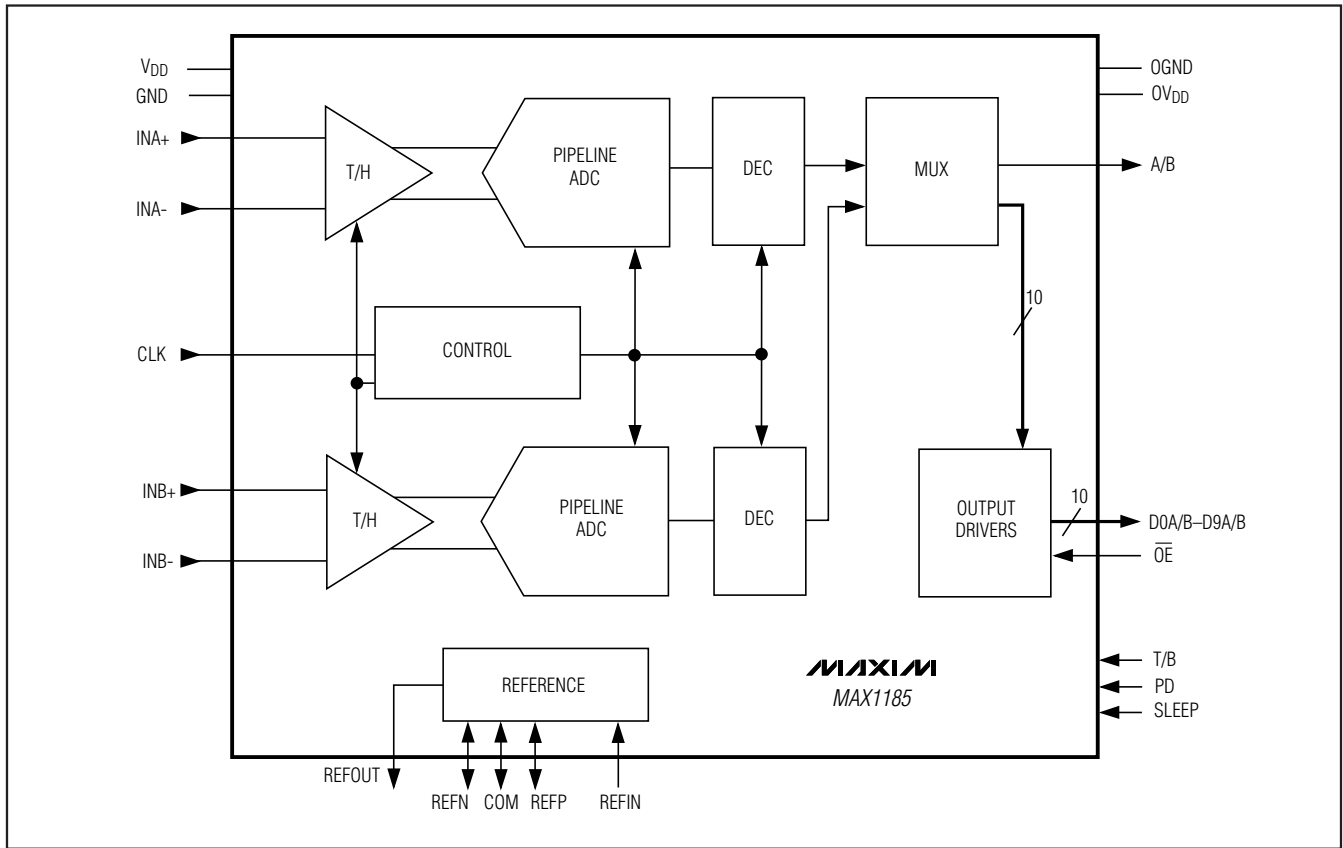

MAX1185

Pin-Compatible Versions

PART	RESOLUTION (Bits)	SPEED GRADE (MSPS)	OUTPUT BUS
MAX1190	10	120	Full duplex
MAX1180	10	105	Full duplex
MAX1181	10	80	Full duplex
MAX1182	10	65	Full duplex
MAX1183	10	40	Full duplex
MAX1186	10	40	Half duplex
MAX1184	10	20	Full duplex
MAX1185	10	20	Half duplex
MAX1198	8	100	Full duplex
MAX1197	8	60	Full duplex
MAX1196	8	40	Half duplex
MAX1195	8	40	Full duplex

Dual 10-Bit, 20Msps, 3V, Low-Power ADC with Internal Reference and Multiplexed Parallel Outputs

Package Information

For the latest package outline information and land patterns (footprints), go to www.maxim-ic.com/packages. Note that a "+", "#", or "-" in the package code indicates RoHS status only. Package drawings may show a different suffix character, but the drawing pertains to the package regardless of RoHS status.

PACKAGE TYPE	PACKAGE CODE	OUTLINE NO.	LAND PATTERN NO.
48 TQFP-EP	C48E+7	21-0065	90-0137

Dual 10-Bit, 20Msps, 3V, Low-Power ADC with Internal Reference and Multiplexed Parallel Outputs

Revision History

REVISION NUMBER	REVISION DATE	DESCRIPTION	PAGES CHANGED
2	4/10	Added automotive qualified part to <i>Ordering Information</i>	1
3	5/11	Corrected pin 13 label in <i>Pin Configuration</i>	1

MAX1185

Maxim cannot assume responsibility for use of any circuitry other than circuitry entirely embodied in a Maxim product. No circuit patent licenses are implied. Maxim reserves the right to change the circuitry and specifications without notice at any time.

Maxim Integrated Products, 120 San Gabriel Drive, Sunnyvale, CA 94086 408-737-7600 _____ 21

AMEYA360

Components Supply Platform

Authorized Distribution Brand :



Website :

Welcome to visit www.ameya360.com

Contact Us :

➤ Address :

401 Building No.5, JiuGe Business Center, Lane 2301, Yishan Rd
Minhang District, Shanghai , China

➤ Sales :

Direct +86 (21) 6401-6692

Email amall@ameya360.com

QQ 800077892

Skype [ameyasales1](#) [ameyasales2](#)

➤ Customer Service :

Email service@ameya360.com

➤ Partnership :

Tel +86 (21) 64016692-8333

Email mkt@ameya360.com