



EVERLIGHT ELECTRONICS CO.,LTD.

# DATA SHEET

PART NO. : 383-2SURC/S400-A8

DATE : 2002/7/22

DEPARTMENT : CHR&D1

REVISION : 1

<b>RECEIVED</b>			
<input checked="" type="checkbox"/> MASS PRODUCTION			
<input type="checkbox"/> PRELIMINARY			
<input type="checkbox"/> CUSTOMER DESIGN			
DEVICE NUMBER : CDLE-038-163			
PAGE : 4			
CUSTOMER	DESIGNER	CHECKER	APPROVER

REV.	DESCRIPTION	RELEASE DATE

Office : 7C Building, Lian Hua Port Industrial District, Lian Hua Shan  
 Bonded Processing Zone Pan Yu, Guang Zhou, China  
 TEL. : (020)84860913,84860914  
 FAX : (020)84860600  
 http : //www.everlight.com



# EVERLIGHT ELECTRONICS CO.,LTD.

Device Number : CDLE-038-163 REV.: 1

5.0mm Round Type LED Lamps

PART NO. : 383-2SURC/S400-A8 ECN: \_\_\_\_\_ Page: 1/4

■ Features :

- Choice of various viewing angles
- Available on tape and reel.
- Reliable and robust

■ Descriptions :

- The series is specially designed for applications requiring higher brightness
- The led lamps are available with different colors, intensities,

■ Applications :

- TV set
- Monitor
- Telephone
- Computer

■ Package Dimensions:

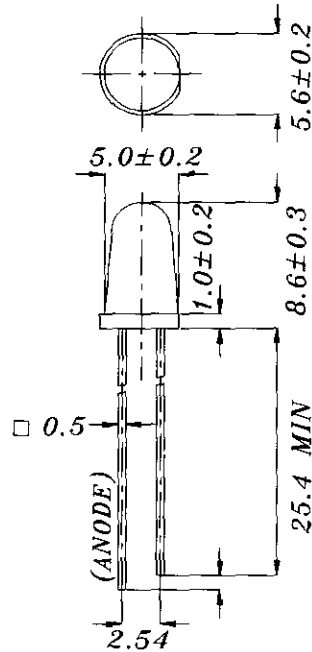

■ Notes :

1. All dimensions are in millimeters.
2. An epoxy meniscus may extend about 1.5mm(0.059") down to the lead.
3. Tolerances unless Dimension  $\pm 0.25$ mm.

PART NO.	Chip		Lens Color
	Material	Emitted Color	
383-2SURC/S400-A8	AlGaInP	Hyper Red	Water Clear

Office : 7C Building, Lian Hua Port Industrial District, Lian Hua Shan  
 Bonded Processing Zone Pan Yu, Guang Zhou, China  
 TEL. : (020)84860913,84860914  
 FAX : (020)84860600  
 http : //www.everlight.com

T02571.R0207069





# EVERLIGHT ELECTRONICS CO.,LTD.

Device Number : CDLE-038-163 REV.: 1

5.0mm Round Type LED Lamps

PART NO. : 383-2SURC/S400-A8 ECN : \_\_\_\_\_ Page: 3/4

## ■ Typical Electro-Optical Characteristic Curves:

(SUR)

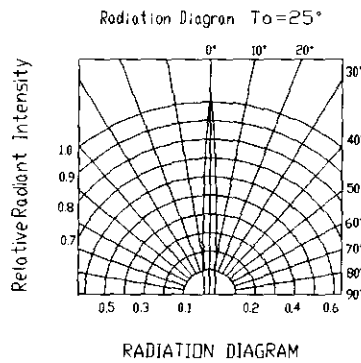
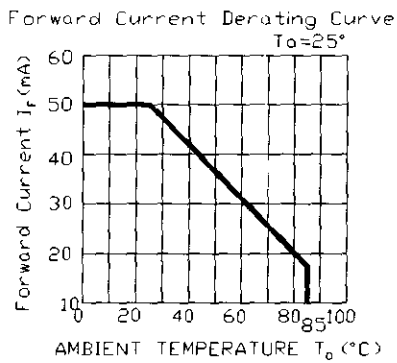
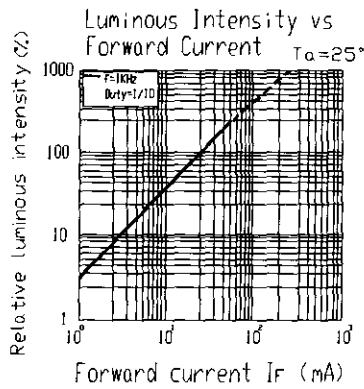
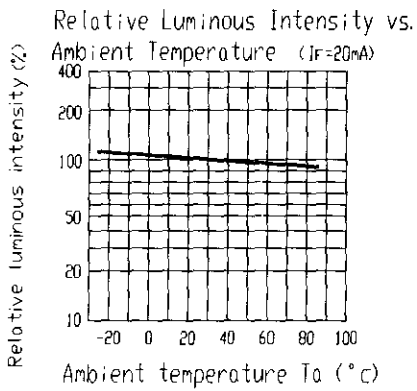
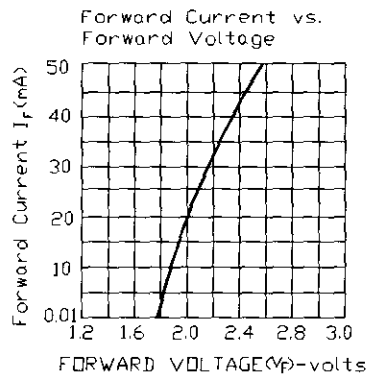
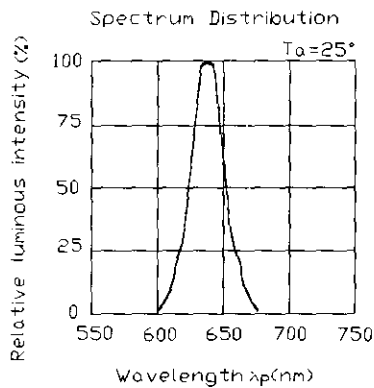



# EVERLIGHT ELECTRONICS CO.,LTD.

Device Number : CDLE-038-163 REV.: 1

5.0mm Round Type LED Lamps

PART NO. : 383-2SURC/S400-A8 ECN : \_\_\_\_\_ Page: 4/4

## ■ Reliability test items and conditions:

NO	Item	Test Conditions	Test Hours/Cycle		Ac/Re
1	Solder Heat	TEMP : 260°C ± 5 °C	5 SEC	76 PCS	0/1
2	Temperature Cycle	H : +85°C 30min § 5 min L : -55°C 30min	50 CYCLES	76 PCS	0/1
3	Thermal Shock	H : +100°C 5min § 10 sec L : -10°C 5min	50 CYCLES	76 PCS	0/1
4	High Temperature Storage	TEMP : 100°C	1000 HRS	76 PCS	0/1
5	Low Temperature Storage	TEMP : -55°C	1000 HRS	76 PCS	0/1
6	DC Operating Life	TEMP : 25°C If = 20mA	1000 HRS	76 PCS	0/1
7	High Temperature / High Humidity	85°C / 85% RH	1000 HRS	76 PCS	0/1

# AMEYA360

Components Supply Platform

Authorized Distribution Brand :



Website :

Welcome to visit [www.ameya360.com](http://www.ameya360.com)

Contact Us :

➤ Address :

401 Building No.5, JiuGe Business Center, Lane 2301, Yishan Rd  
Minhang District, Shanghai , China

➤ Sales :

Direct +86 (21) 6401-6692

Email [amall@ameya360.com](mailto:amall@ameya360.com)

QQ 800077892

Skype ameyasales1 ameyasales2

➤ Customer Service :

Email [service@ameya360.com](mailto:service@ameya360.com)

➤ Partnership :

Tel +86 (21) 64016692-8333

Email [mkt@ameya360.com](mailto:mkt@ameya360.com)