

TLC227x, TLC227xA Advanced LinCMOS™ RAIL-TO-RAIL OPERATIONAL AMPLIFIERS

SLOS190G – FEBRUARY 1997 – REVISED MAY 2004

- Output Swing Includes Both Supply Rails
- Low Noise . . . 9 nV/√Hz Typ at f = 1 kHz
- Low Input Bias Current . . . 1 pA Typ
- Fully Specified for Both Single-Supply and Split-Supply Operation
- Common-Mode Input Voltage Range Includes Negative Rail
- High-Gain Bandwidth . . . 2.2 MHz Typ
- High Slew Rate . . . 3.6 V/μs Typ
- Low Input Offset Voltage
950 μV Max at T_A = 25°C
- Macromodel Included
- Performance Upgrades for the TS272, TS274, TLC272, and TLC274
- Available in Q-Temp Automotive HighRel Automotive Applications Configuration Control / Print Support Qualification to Automotive Standards

description

The TLC2272 and TLC2274 are dual and quadruple operational amplifiers from Texas Instruments. Both devices exhibit rail-to-rail output performance for increased dynamic range in single- or split-supply applications. The TLC227x family offers 2 MHz of bandwidth and 3 V/μs of slew rate for higher speed applications. These devices offer comparable ac performance while having better noise, input offset voltage, and power dissipation than existing CMOS operational amplifiers. The TLC227x has a noise voltage of 9 nV/√Hz, two times lower than competitive solutions.

The TLC227x, exhibiting high input impedance and low noise, is excellent for small-signal conditioning for high-impedance sources, such as piezoelectric transducers. Because of the micro-power dissipation levels, these devices work well in hand-held monitoring and remote-sensing applications. In addition, the rail-to-rail output feature, with single- or split-supplies, makes this family a great choice when interfacing with analog-to-digital converters (ADCs). For precision applications, the TLC227xA family is available with a maximum input offset voltage of 950 μV. This family is fully characterized at 5 V and ±5 V.

The TLC2272/4 also makes great upgrades to the TLC272/4 or TS272/4 in standard designs. They offer increased output dynamic range, lower noise voltage, and lower input offset voltage. This enhanced feature set allows them to be used in a wider range of applications. For applications that require higher output drive and wider input voltage range, see the TLV2432 and TLV2442 devices.

If the design requires single amplifiers, see the TLV2211/21/31 family. These devices are single rail-to-rail operational amplifiers in the SOT-23 package. Their small size and low power consumption, make them ideal for high density, battery-powered equipment.

MAXIMUM PEAK-TO-PEAK OUTPUT VOLTAGE
VS
SUPPLY VOLTAGE

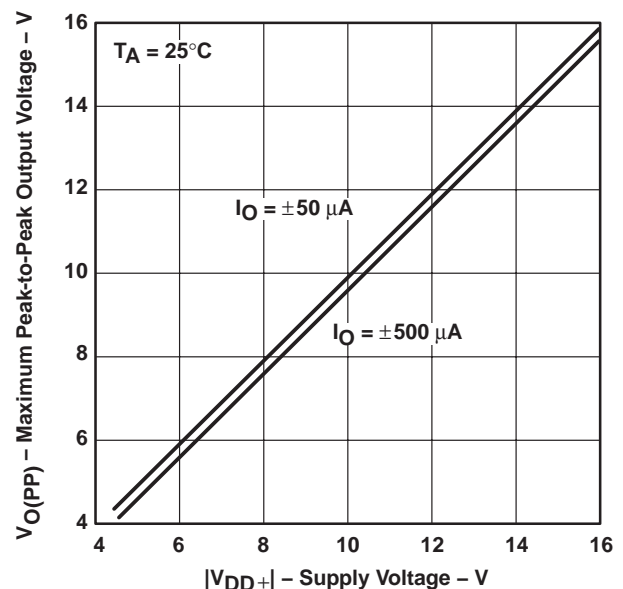

Please be aware that an important notice concerning availability, standard warranty, and use in critical applications of Texas Instruments semiconductor products and disclaimers thereto appears at the end of this data sheet.

Advanced LinCMOS is a trademark of Texas Instruments.

PRODUCTION DATA information is current as of publication date. Products conform to specifications per the terms of Texas Instruments standard warranty. Production processing does not necessarily include testing of all parameters.

 **TEXAS
INSTRUMENTS**

POST OFFICE BOX 655303 • DALLAS, TEXAS 75265

Copyright © 2004, Texas Instruments Incorporated
On products compliant to MIL-PRF-38535, all parameters are tested unless otherwise noted. On all other products, production processing does not necessarily include testing of all parameters.

TLC227x, TLC227xA

Advanced LinCMOS™ RAIL-TO-RAIL OPERATIONAL AMPLIFIERS

SLOS190G – FEBRUARY 1997 – REVISED MAY 2004

TLC2272 AVAILABLE OPTIONS

| T _A | V _{IOMAX} At 25°C | PACKAGED DEVICES | | | | | |
|----------------|----------------------------|-------------------------|---------------------------|---------------------------|-------------------------|---------------------------|-------------------------|
| | | SMALL OUTLINE† (D) | CERAMIC LCC (FK) | CERAMIC DIP (JG) | PLASTIC DIP (P) | TSSOP‡ (PW) | CERAMIC FLAT PACK (U) |
| 0°C to 70°C | 950 μV 2.5 mV | TLC2272ACD TLC2272CD | — — | — — | TLC2272ACP TLC2272CP | TLC2272ACPW TLC2272CPW | — — |
| -40°C to 125°C | 950 μV 2.5 mV | TLC2272AID TLC2272ID | — — | — — | TLC2272AIP TLC2272IP | — TLC2272IPW | — — |
| | 950 μV 2.5 mV | TLC2272AQD TLC2272QD | — — | — — | — | TLC2272AQPW TLC2272QPW | — — |
| -55°C to 125°C | 950 μV 2.5 mV | TLC2272AMD TLC2272MD | TLC2272AMFK TLC2272MFK | TLC2272AMJG TLC2272MJG | TLC2272AMP TLC2272MP | — | TLC2272AMU TLC2272MU |

† The D packages are available taped and reeled. Add R suffix to the device type (e.g., TLC2272CDR).

‡ The PW package is available taped and reeled. Add R suffix to the device type (e.g., TLC2272PWR).

§ Chips are tested at 25°C.

TLC2274 AVAILABLE OPTIONS

| T _A | V _{IOMAX} AT 25°C | PACKAGED DEVICES | | | | | |
|----------------|----------------------------|-------------------------|---------------------------|-------------------------|-------------------------|---------------------------|-------------------------|
| | | SMALL OUTLINE† (D) | CERAMIC LCC (FK) | CERAMIC DIP (J) | PLASTIC DIP (N) | TSSOP‡ (PW) | CERAMIC FLAT PACK (W) |
| 0°C to 70°C | 950 μV 2.5 mV | TLC2274ACD TLC2274CD | — | — | TLC2274ACN TLC2274CN | TLC2274ACPW TLC2274CPW | — |
| -40°C to 125°C | 950 μV 2.5 mV | TLC2274AID TLC2274ID | — | — | TLC2274AIN TLC2274IN | TLC2274AIPW TLC2274IPW | — |
| | 950 μV 2.5 mV | TLC2274AQD TLC2274QD | — | — | — | — | — |
| -55°C to 125°C | 950 μV 2.5 mV | TLC2274AMD TLC2274MD | TLC2274AMFK TLC2274MFK | TLC2274AMJ TLC2274MJ | TLC2274AMN TLC2274MN | — | TLC2274AMW TLC2274MW |

† The D packages are available taped and reeled. Add R suffix to device type (e.g., TLC2274CDR).

‡ The PW package is available taped and reeled.

§ Chips are tested at 25°C.



TLC227x, TLC227xA Advanced LinCMOS™ RAIL-TO-RAIL OPERATIONAL AMPLIFIERS

SLOS190G – FEBRUARY 1997 – REVISED MAY 2004

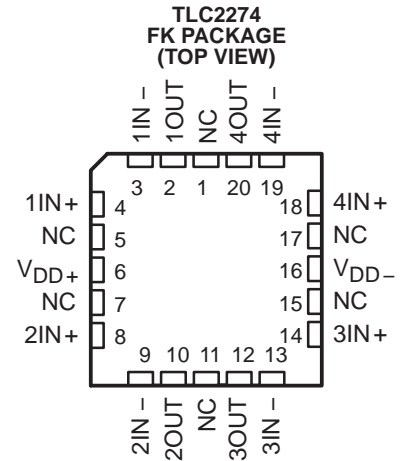
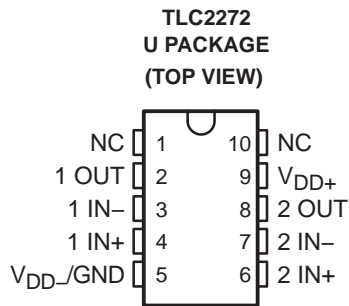
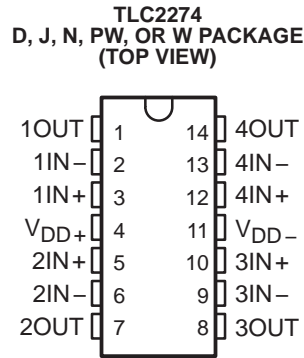
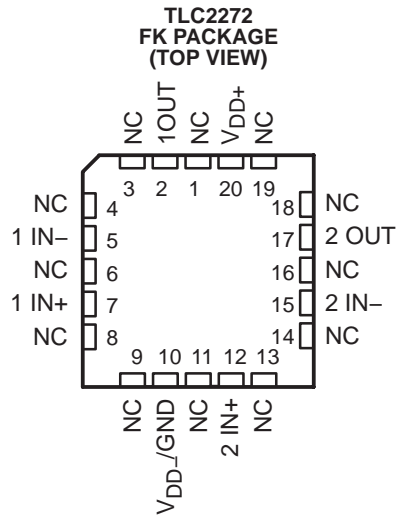
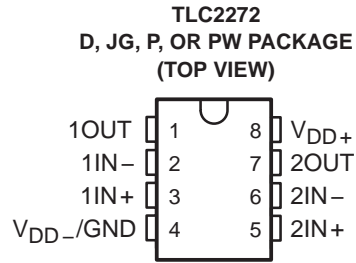

NC – No internal connection

TLC227x, TLC227xA Advanced LinCMOS™ RAIL-TO-RAIL OPERATIONAL AMPLIFIERS

SLOS190G – FEBRUARY 1997 – REVISED MAY 2004

equivalent schematic (each amplifier)

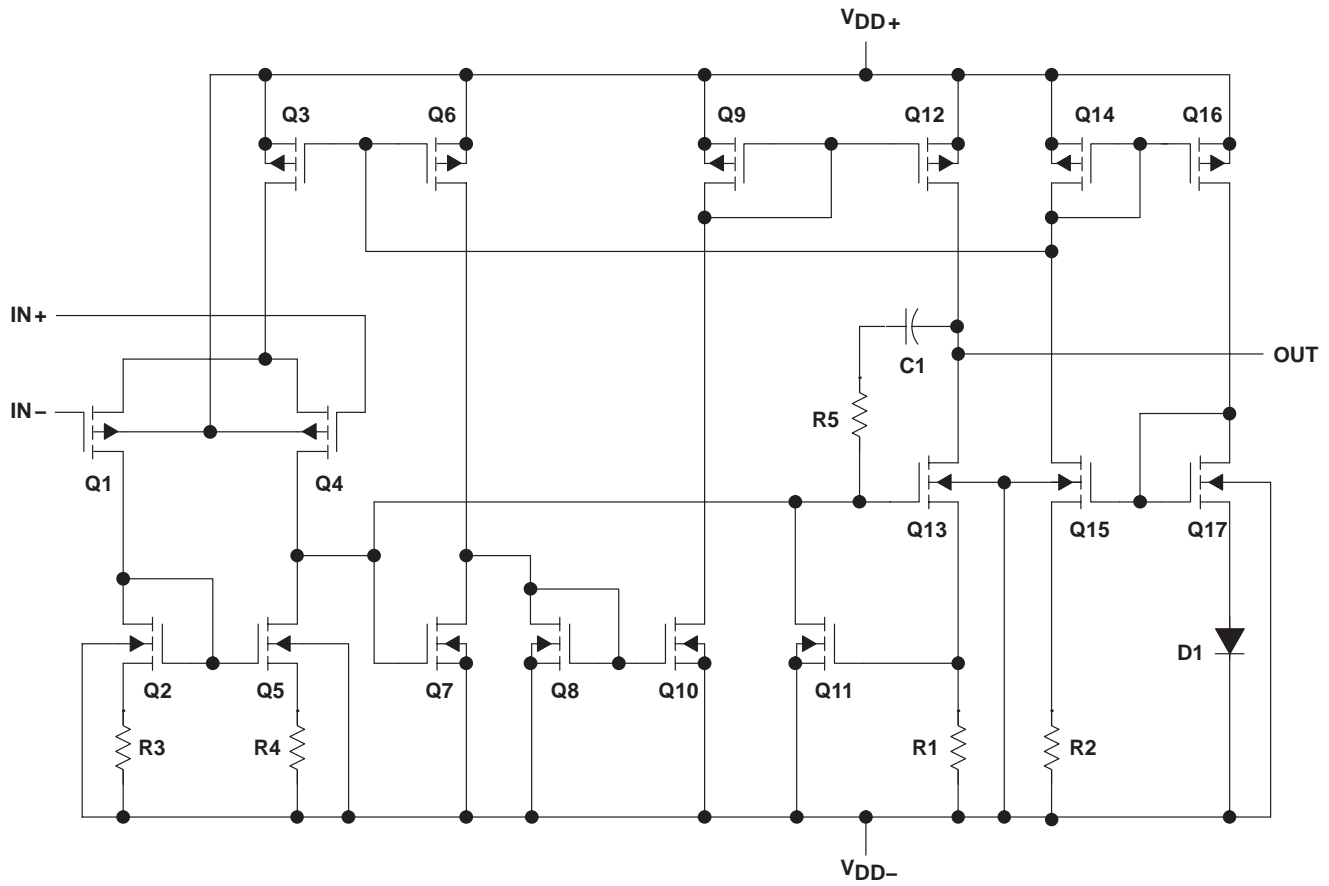

| ACTUAL DEVICE COMPONENT COUNT† | | |
|--------------------------------|---------|---------|
| COMPONENT | TLC2272 | TLC2274 |
| Transistors | 38 | 76 |
| Resistors | 26 | 52 |
| Diodes | 9 | 18 |
| Capacitors | 3 | 6 |

† Includes both amplifiers and all ESD, bias, and trim circuitry

absolute maximum ratings over operating free-air temperature range (unless otherwise noted)†

| | |
|-------------------------------------------------------------------------------------|----------------------------------------|
| Supply voltage, V_{DD+} (see Note 1) | 8 V |
| Supply voltage, V_{DD-} (see Note 1) | –8 V |
| Differential input voltage, V_{ID} (see Note 2) | ±16 V |
| Input voltage range, V_I (any input, see Note 1) | $V_{DD-} - 0.3 \text{ V}$ to V_{DD+} |
| Input current, I_I (any input) | ±5 mA |
| Output current, I_O | ±50 mA |
| Total current into V_{DD+} | ±50 mA |
| Total current out of V_{DD-} | ±50 mA |
| Duration of short-circuit current at (or below) 25°C (see Note 3) | unlimited |
| Package thermal impedance, θ_{JA} (see Notes 4 and 5): D package (8 pin) | 97.1°C/W |
| D package (14 pin) | 86.2°C/W |
| N package | 79.7°C/W |
| P package | 84.6°C/W |
| PW package (8 pin) | 149°C/W |
| PW package (14 pin) | 113°C/W |
| Package thermal impedance, θ_{JC} (see Notes 4 and 5): FK package | 5.6°C/W |
| J package | 15.1°C/W |
| U package | 14.7°C/W |
| Operating free-air temperature range, T_A : C suffix | 0°C to 70°C |
| I, Q suffix | –40°C to 125°C |
| M suffix | –55°C to 125°C |
| Storage temperature range | –65°C to 150°C |
| Lead temperature 1,6 mm (1/16 inch) from case for 10 seconds: D, N, P or PW package | 260°C |
| Lead temperature 1,6 mm (1/16 inch) from case for 60 seconds: J or U package | 300°C |

† Stresses beyond those listed under “absolute maximum ratings” may cause permanent damage to the device. These are stress ratings only, and functional operation of the device at these or any other conditions beyond those indicated under “recommended operating conditions” is not implied. Exposure to absolute-maximum-rated conditions for extended periods may affect device reliability.

- NOTES:
1. All voltage values, except differential voltages, are with respect to the midpoint between V_{DD+} and V_{DD-} .
 2. Differential voltages are at $IN+$ with respect to $IN-$. Excessive current will flow if input is brought below $V_{DD-} - 0.3 \text{ V}$.
 3. The output may be shorted to either supply. Temperature and/or supply voltages must be limited to ensure that the maximum dissipation rating is not exceeded.
 4. Maximum power dissipation is a function of $T_J(\text{max})$, θ_{JA} , and T_A . The maximum allowable power dissipation at any allowable ambient temperature is $P_D = (T_J(\text{max}) - T_A)/\theta_{JA}$. Operating at the absolute maximum T_J of 150°C can affect reliability.
 5. The package thermal impedance is calculated in accordance with JESD 51-7 (plastic) or MIL-STD-883 Method 1012 (ceramic).

recommended operating conditions

| | C SUFFIX | | I SUFFIX | | Q SUFFIX | | M SUFFIX | | UNIT |
|---------------------------------------|-----------|-----------------|-----------|-----------------|-----------|-----------------|-----------|-----------------|------|
| | MIN | MAX | MIN | MAX | MIN | MAX | MIN | MAX | |
| Supply voltage, $V_{DD\pm}$ | ±2.2 | ±8 | ±2.2 | ±8 | ±2.2 | ±8 | ±2.2 | ±8 | V |
| Input voltage, V_I | V_{DD-} | $V_{DD+} - 1.5$ | V_{DD-} | $V_{DD+} - 1.5$ | V_{DD-} | $V_{DD+} - 1.5$ | V_{DD-} | $V_{DD+} - 1.5$ | V |
| Common-mode input voltage, V_{IC} | V_{DD-} | $V_{DD+} - 1.5$ | V_{DD-} | $V_{DD+} - 1.5$ | V_{DD-} | $V_{DD+} - 1.5$ | V_{DD-} | $V_{DD+} - 1.5$ | V |
| Operating free-air temperature, T_A | 0 | 70 | –40 | 125 | –40 | 125 | –55 | 125 | °C |

TLC227x, TLC227xA Advanced LinCMOS™ RAIL-TO-RAIL OPERATIONAL AMPLIFIERS

SLOS190G – FEBRUARY 1997 – REVISED MAY 2004

TLC2272C electrical characteristics at specified free-air temperature, $V_{DD} = 5\text{ V}$ (unless otherwise noted)

| PARAMETER | TEST CONDITIONS | T_A † | TLC2272C | | | TLC2272AC | | | UNIT |
|----------------------------------------------------------------------------|--------------------------------------------------------------------------------------------------------|-----------------------------|------------|-------------|------|-----------|-------------|------------------------------|----------------------|
| | | | MIN | TYP | MAX | MIN | TYP | MAX | |
| V_{IO} Input offset voltage | $V_{IC} = 0\text{ V}$, $V_{DD} = \pm 2.5\text{ V}$, $V_O = 0\text{ V}$, $R_S = 50\ \Omega$ | 25°C | 300 | 2500 | | 300 | 950 | μV | |
| | | Full range | | | 3000 | | 1500 | | |
| α_{VIO} Temperature coefficient of input offset voltage | | 25°C to 70°C | 2 | | | 2 | | $\mu\text{V}/^\circ\text{C}$ | |
| Input offset voltage long-term drift (see Note 4) | | 25°C | 0.002 | | | 0.002 | | $\mu\text{V}/\text{mo}$ | |
| I_{IO} Input offset current | | 25°C | 0.5 | 60 | | 0.5 | 60 | pA | |
| | | Full range | | | 100 | | 100 | | |
| I_{IB} Input bias current | 25°C | 1 | 60 | | 1 | 60 | pA | | |
| | Full range | | | 100 | | 100 | | | |
| V_{ICR} Common-mode input voltage | $R_S = 50\ \Omega$, $ V_{IO} \leq 5\text{ mV}$ | 25°C | 0 to 4 | -0.3 to 4.2 | | 0 to 4 | -0.3 to 4.2 | V | |
| | | Full range | 0 to 3.5 | | | 0 to 3.5 | | | |
| V_{OH} High-level output voltage | $I_{OH} = -20\ \mu\text{A}$ | 25°C | | 4.99 | | | 4.99 | V | |
| | | 25°C | 4.85 | 4.93 | | 4.85 | 4.93 | | |
| | | Full range | 4.85 | | | 4.85 | | | |
| | | 25°C | 4.25 | 4.65 | | 4.25 | 4.65 | | |
| V_{OL} Low-level output voltage | $I_{OL} = 50\ \mu\text{A}$ | 25°C | | 0.01 | | | 0.01 | V | |
| | | 25°C | 0.09 | 0.15 | | 0.09 | 0.15 | | |
| | | Full range | | | 0.15 | | 0.15 | | |
| | | 25°C | 0.9 | 1.5 | | 0.9 | 1.5 | | |
| V_{OL} Low-level output voltage | $I_{OL} = 500\ \mu\text{A}$ | 25°C | | 0.01 | | | 0.01 | V | |
| | | 25°C | 0.09 | 0.15 | | 0.09 | 0.15 | | |
| | | Full range | | | 0.15 | | 0.15 | | |
| | | 25°C | 0.9 | 1.5 | | 0.9 | 1.5 | | |
| V_{OL} Low-level output voltage | $I_{OL} = 5\text{ mA}$ | 25°C | | 0.01 | | | 0.01 | V | |
| | | 25°C | 0.09 | 0.15 | | 0.09 | 0.15 | | |
| | | Full range | | | 0.15 | | 0.15 | | |
| | | 25°C | 0.9 | 1.5 | | 0.9 | 1.5 | | |
| A_{VD} Large-signal differential voltage amplification | $V_{IC} = 2.5\text{ V}$, $V_O = 1\text{ V to }4\text{ V}$ | $R_L = 10\text{ k}\Omega$ ‡ | 25°C | 15 | 35 | | 15 | 35 | V/mV |
| | | | Full range | 15 | | | 15 | | |
| | | | 25°C | | 175 | | | 175 | |
| A_{VD} Large-signal differential voltage amplification | $V_{IC} = 2.5\text{ V}$, $V_O = 1\text{ V to }4\text{ V}$ | $R_L = 1\text{ m}\Omega$ ‡ | 25°C | | 175 | | | 175 | V/mV |
| | | | Full range | | | 175 | | | |
| | | | 25°C | | 175 | | | 175 | |
| r_{id} Differential input resistance | | 25°C | | 10^{12} | | | 10^{12} | Ω | |
| r_i Common-mode input resistance | | 25°C | | 10^{12} | | | 10^{12} | Ω | |
| C_i Common-mode input capacitance | $f = 10\text{ kHz}$, P package | 25°C | | 8 | | | 8 | pF | |
| z_o Closed-loop output impedance | $f = 1\text{ MHz}$, $A_V = 10$ | 25°C | | 140 | | | 140 | Ω | |
| CMRR Common-mode rejection ratio | $V_{IC} = 0\text{ V to }2.7\text{ V}$, $V_O = 2.5\text{ V}$, $R_S = 50\ \Omega$ | 25°C | 70 | 75 | | 70 | 75 | dB | |
| | | Full range | 70 | | | 70 | | | |
| k_{SVR} Supply-voltage rejection ratio ($\Delta V_{DD}/\Delta V_{IO}$) | $V_{DD} = 4.4\text{ V to }16\text{ V}$, $V_{IC} = V_{DD}/2$, No load | 25°C | 80 | 95 | | 80 | 95 | dB | |
| | | Full range | 80 | | | 80 | | | |
| I_{DD} Supply current | $V_O = 2.5\text{ V}$, No load | 25°C | 2.2 | 3 | | 2.2 | 3 | mA | |
| | | Full range | | | 3 | | 3 | | |

† Full range is 0°C to 70°C.

‡ Referenced to 0 V

NOTE 6: Typical values are based on the input offset voltage shift observed through 168 hours of operating life test at $T_A = 150^\circ\text{C}$ extrapolated to $T_A = 25^\circ\text{C}$ using the Arrhenius equation and assuming an activation energy of 0.96 eV.



TLC227x, TLC227xA
Advanced LinCMOS™ RAIL-TO-RAIL
OPERATIONAL AMPLIFIERS

SLOS190G – FEBRUARY 1997 – REVISED MAY 2004

TLC2272C operating characteristics at specified free-air temperature, $V_{DD} = 5\text{ V}$

| PARAMETER | TEST CONDITIONS | T_A † | TLC2272C | | | TLC2272AC | | | UNIT |
|-----------|----------------------------------------------------------------------------------------------------------------------------------------|---------------------------------------------------------------------------------------------------|----------------------------------------|---------|--------|-----------|---------|------------------------|------------------------|
| | | | MIN | TYP | MAX | MIN | TYP | MAX | |
| SR | Slew rate at unity gain $V_O = 0.5\text{ V to }2.5\text{ V}$, $R_L = 10\text{ k}\Omega$ ‡, $C_L = 100\text{ pF}$ ‡ | 25°C | 2.3 | 3.6 | | 2.3 | 3.6 | | V/ μs |
| | | Full range | 1.7 | | | 1.7 | | | |
| V_n | Equivalent input noise voltage | $f = 10\text{ Hz}$ | | 50 | | | 50 | | nV/ $\sqrt{\text{Hz}}$ |
| | | $f = 1\text{ kHz}$ | | 9 | | | 9 | | |
| V_{NPP} | Peak-to-peak equivalent input noise voltage | $f = 0.1\text{ Hz to }1\text{ Hz}$ | | 1 | | | 1 | | μV |
| | | $f = 0.1\text{ Hz to }10\text{ Hz}$ | | 1.4 | | | 1.4 | | |
| I_n | Equivalent input noise current | 25°C | | 0.6 | | | 0.6 | fA/ $\sqrt{\text{Hz}}$ | |
| THD + N | Total harmonic distortion plus noise $V_O = 0.5\text{ V to }2.5\text{ V}$, $f = 20\text{ kHz}$, $R_L = 10\text{ k}\Omega$ ‡ | $A_V = 1$ | | 0.0013% | | | 0.0013% | | |
| | | $A_V = 10$ | 25°C | | 0.004% | | | 0.004% | |
| | | $A_V = 100$ | | | 0.03% | | | 0.03% | |
| | Gain-bandwidth product | $f = 10\text{ kHz}$, $C_L = 100\text{ pF}$ ‡ | $R_L = 10\text{ k}\Omega$ ‡ | 25°C | | 2.18 | | 2.18 | MHz |
| B_{OM} | Maximum output-swing bandwidth | $V_{O(PP)} = 2\text{ V}$, $R_L = 10\text{ k}\Omega$ ‡ | $A_V = 1$, $C_L = 100\text{ pF}$ ‡ | 25°C | | 1 | | 1 | MHz |
| t_s | Settling time | $A_V = -1$, Step = 0.5 V to 2.5 V, $R_L = 10\text{ k}\Omega$ ‡, $C_L = 100\text{ pF}$ ‡ | To 0.1% | 25°C | | 1.5 | | 1.5 | μs |
| | | | To 0.01% | | | 2.6 | | 2.6 | |
| ϕ_m | Phase margin at unity gain | $R_L = 10\text{ k}\Omega$ ‡, $C_L = 100\text{ pF}$ ‡ | | 25°C | | 50° | | 50° | |
| | Gain margin | | | 25°C | | 10 | | 10 | dB |

† Full range is 0°C to 70°C.

‡ Referenced to 0 V

TLC227x, TLC227xA Advanced LinCMOS™ RAIL-TO-RAIL OPERATIONAL AMPLIFIERS

SLOS190G – FEBRUARY 1997 – REVISED MAY 2004

TLC2272C electrical characteristics at specified free-air temperature, $V_{DD\pm} = \pm 5\text{ V}$ (unless otherwise specified)

| PARAMETER | TEST CONDITIONS | T_A † | TLC2272C | | | TLC2272AC | | | UNIT |
|---------------------------------------------------------------------------------|-------------------------------------------------------------------------------------|------------------------------------------|------------|-------------|------|-----------|-------------|---------------|------------------------------|
| | | | MIN | TYP | MAX | MIN | TYP | MAX | |
| V_{IO} Input offset voltage | $V_{IC} = 0\text{ V}, R_S = 50\ \Omega, V_O = 0\text{ V},$ | 25°C | 300 | 2500 | | 300 | 950 | μV | |
| | | Full range | | | 3000 | | 1500 | | |
| α_{VIO} Temperature coefficient of input offset voltage | | 25°C to 70°C | 2 | | | 2 | | | $\mu\text{V}/^\circ\text{C}$ |
| Input offset voltage long-term drift (see Note 4) | | 25°C | 0.002 | | | 0.002 | | | $\mu\text{V}/\text{mo}$ |
| I_{IO} Input offset current | | 25°C | 0.5 | 60 | | 0.5 | 60 | pA | |
| | | Full range | | | 100 | | 100 | | |
| I_{IB} Input bias current | 25°C | 1 | | | 1 | | | pA | |
| | Full range | | | 100 | | 100 | | | |
| V_{ICR} Common-mode input voltage | $R_S = 50\ \Omega, V_{IO} \leq 5\text{ mV}$ | 25°C | -5 to 4 | -5.3 to 4.2 | | -5 to 4 | -5.3 to 4.2 | V | |
| | | Full range | -5 to 3.5 | | | -5 to 3.5 | | | |
| V_{OM+} Maximum positive peak output voltage | $I_O = -20\ \mu\text{A}$ | 25°C | 4.99 | | | 4.99 | | | V |
| | | 25°C | 4.85 | 4.93 | | 4.85 | 4.93 | | |
| | $I_O = -1\text{ mA}$ | 25°C | 4.25 | 4.65 | | 4.25 | 4.65 | | |
| | | Full range | 4.25 | | | 4.25 | | | |
| V_{OM-} Maximum negative peak output voltage | $V_{IC} = 0\text{ V}, I_O = 50\ \mu\text{A}$ | 25°C | -4.99 | | | -4.99 | | | V |
| | | 25°C | -4.85 | -4.91 | | -4.85 | -4.91 | | |
| | $V_{IC} = 0\text{ V}, I_O = 500\ \mu\text{A}$ | Full range | -4.85 | | | -4.85 | | | |
| | | $V_{IC} = 0\text{ V}, I_O = 5\text{ mA}$ | 25°C | -3.5 | -4.1 | | -3.5 | -4.1 | |
| Full range | -3.5 | | | -3.5 | | | | | |
| AVD Large-signal differential voltage amplification | $V_O = \pm 4\text{ V}$ | $R_L = 10\ \text{k}\Omega$ | 25°C | 25 | 50 | | 25 | 50 | V/mV |
| | | | Full range | 25 | | | 25 | | |
| | | $R_L = 1\ \text{m}\Omega$ | 25°C | 300 | | | 300 | | |
| r_{id} Differential input resistance | | 25°C | 1012 | | | 1012 | | | Ω |
| r_i Common-mode input resistance | | 25°C | 1012 | | | 1012 | | | Ω |
| c_i Common-mode input capacitance | $f = 10\ \text{kHz}, \text{ P package}$ | 25°C | 8 | | | 8 | | | pF |
| z_o Closed-loop output impedance | $f = 1\ \text{MHz}, A_V = 10$ | 25°C | 130 | | | 130 | | | Ω |
| CMRR Common-mode rejection ratio | $V_{IC} = -5\text{ V to } 2.7\text{ V}, V_O = 0\text{ V}, R_S = 50\ \Omega$ | 25°C | 75 | 80 | | 75 | 80 | dB | |
| | | Full range | 75 | | | 75 | | | |
| k_{SVR} Supply-voltage rejection ratio ($\Delta V_{DD\pm} / \Delta V_{IO}$) | $V_{DD\pm} = 2.2\text{ V to } \pm 8\text{ V}, V_{IC} = 0\text{ V}, \text{ No load}$ | 25°C | 80 | 95 | | 80 | 95 | dB | |
| | | Full range | 80 | | | 80 | | | |
| I_{DD} Supply current | $V_O = 0\text{ V}, \text{ No load}$ | 25°C | 2.4 | | | 2.4 | | | mA |
| | | Full range | | | 3 | | 3 | | |

† Full range is 0°C to 70°C.

NOTE 4: Typical values are based on the input offset voltage shift observed through 168 hours of operating life test at $T_A = 150^\circ\text{C}$ extrapolated to $T_A = 25^\circ\text{C}$ using the Arrhenius equation and assuming an activation energy of 0.96 eV.



TLC227x, TLC227xA
Advanced LinCMOS™ RAIL-TO-RAIL
OPERATIONAL AMPLIFIERS

SLOS190G – FEBRUARY 1997 – REVISED MAY 2004

TLC2272C operating characteristics at specified free-air temperature, $V_{DD\pm} = \pm 5\text{ V}$

| PARAMETER | TEST CONDITIONS | T_A † | TLC2272C | | | TLC2272AC | | | UNIT |
|-----------|--------------------------------------------------------------------------------------------------------------------|--------------------------------------------------------------------------------------------------------------------|----------|------|---------|-----------|---------|------------------------|------------------------|
| | | | MIN | TYP | MAX | MIN | TYP | MAX | |
| SR | Slew rate at unity gain $V_O = \pm 2.3\text{ V}$, $C_L = 100\text{ pF}$, $R_L = 10\text{ k}\Omega$ | 25°C | 2.3 | 3.6 | | 2.3 | 3.6 | | V/ μs |
| | | Full range | 1.7 | | | 1.7 | | | |
| V_n | Equivalent input noise voltage | f = 10 Hz | | 50 | | | 50 | | nV/ $\sqrt{\text{Hz}}$ |
| | | f = 1 kHz | 25°C | | 9 | | 9 | | |
| V_{NPP} | Peak-to-peak equivalent input noise voltage | f = 0.1 Hz to 1 Hz | 25°C | | 1 | | 1 | | μV |
| | | f = 0.1 Hz to 10 Hz | 25°C | | 1.4 | | 1.4 | | |
| I_n | Equivalent input noise current | | 25°C | | 0.6 | | 0.6 | fA/ $\sqrt{\text{Hz}}$ | |
| THD + N | Total harmonic distortion pulse duration $V_O = \pm 2.3\text{ V}$, f = 20 kHz, $R_L = 10\text{ k}\Omega$ | $A_V = 1$ | 25°C | | 0.0011% | | 0.0011% | | |
| | | $A_V = 10$ | | | 0.004% | | 0.004% | | |
| | | $A_V = 100$ | | | 0.03% | | 0.03% | | |
| | Gain-bandwidth product | f = 10 kHz, $R_L = 10\text{ k}\Omega$, $C_L = 100\text{ pF}$ | 25°C | | 2.25 | | 2.25 | MHz | |
| BOM | Maximum output-swing bandwidth | $V_{O(PP)} = 4.6\text{ V}$, $R_L = 10\text{ k}\Omega$, $A_V = 1$, $C_L = 100\text{ pF}$ | 25°C | | 0.54 | | 0.54 | MHz | |
| t_s | Settling time | $A_V = -1$, Step = -2.3 V to 2.3 V , $R_L = 10\text{ k}\Omega$, $C_L = 100\text{ pF}$ | To 0.1% | 25°C | | 1.5 | | 1.5 | μs |
| | | | To 0.01% | | | 3.2 | | 3.2 | |
| ϕ_m | Phase margin at unity gain | $R_L = 10\text{ k}\Omega$, $C_L = 100\text{ pF}$ | 25°C | | 52° | | 52° | | |
| | Gain margin | | 25°C | | 10 | | 10 | dB | |

† Full range is 0°C to 70°C.

TLC227x, TLC227xA Advanced LinCMOS™ RAIL-TO-RAIL OPERATIONAL AMPLIFIERS

SLOS190G – FEBRUARY 1997 – REVISED MAY 2004

TLC2274C electrical characteristics at specified free-air temperature, $V_{DD} = 5\text{ V}$ (unless otherwise noted)

| PARAMETER | TEST CONDITIONS | T_A † | TLC2274C | | | TLC2274AC | | | UNIT |
|----------------------------------------------------------------------------|-----------------------------------------------------------------------------------------------------------|-----------------------------|------------|-------------|------|-----------|-------------|----------------------|------------------------------|
| | | | MIN | TYP | MAX | MIN | TYP | MAX | |
| V_{IO} Input offset voltage | $V_{DD\pm} = \pm 2.5\text{ V}$, $V_O = 0\text{ V}$, $V_{IC} = 0\text{ V}$, $R_S = 50\ \Omega$ | 25°C | 300 | 2500 | | 300 | 950 | μV | |
| | | Full range | | | 3000 | | 1500 | | |
| α_{VIO} Temperature coefficient of input offset voltage | | 25°C to 70°C | 2 | | | 2 | | | $\mu\text{V}/^\circ\text{C}$ |
| Input offset voltage long-term drift (see Note 4) | | 25°C | 0.002 | | | 0.002 | | | $\mu\text{V}/\text{mo}$ |
| I_{IO} Input offset current | | 25°C | 0.5 | 60 | | 0.5 | 60 | pA | |
| | | Full range | | | 100 | | 100 | | |
| I_{IB} Input bias current | | 25°C | 1 | 60 | | 1 | 60 | pA | |
| | | Full range | | | 100 | | 100 | | |
| V_{ICR} Common-mode input voltage | $R_S = 50\ \Omega$, $ V_{IO} \leq 5\text{ mV}$ | 25°C | 0 to 4 | -0.3 to 4.2 | | 0 to 4 | -0.3 to 4.2 | V | |
| | | Full range | 0 to 3.5 | | | 0 to 3.5 | | | |
| V_{OH} High-level output voltage | $I_{OH} = -20\ \mu\text{A}$ | 25°C | 4.99 | | 4.99 | | V | | |
| | | 25°C | 4.85 | 4.93 | 4.85 | 4.93 | | | |
| | | Full range | 4.85 | | 4.85 | | | | |
| | | 25°C | 4.25 | 4.65 | 4.25 | 4.65 | | | |
| V_{OL} Low-level output voltage | $I_{OL} = -1\text{ mA}$ | 25°C | 0.01 | | 0.01 | | V | | |
| | | 25°C | 0.09 | 0.15 | 0.09 | 0.15 | | | |
| | | Full range | 0.15 | | 0.15 | | | | |
| | | 25°C | 0.9 | 1.5 | 0.9 | 1.5 | | | |
| V_{OL} Low-level output voltage | $V_{IC} = 2.5\text{ V}$, $I_{OL} = 500\ \mu\text{A}$ | 25°C | 0.01 | | 0.01 | | V | | |
| | | 25°C | 0.09 | 0.15 | 0.09 | 0.15 | | | |
| | | Full range | 0.15 | | 0.15 | | | | |
| | | 25°C | 0.9 | 1.5 | 0.9 | 1.5 | | | |
| V_{OL} Low-level output voltage | $V_{IC} = 2.5\text{ V}$, $I_{OL} = 5\text{ mA}$ | 25°C | 0.01 | | 0.01 | | V | | |
| | | 25°C | 0.09 | 0.15 | 0.09 | 0.15 | | | |
| | | Full range | 0.15 | | 0.15 | | | | |
| A_{VD} Large-signal differential voltage amplification | $V_{IC} = 2.5\text{ V}$, $V_O = 1\text{ V to }4\text{ V}$ | $R_L = 10\text{ k}\Omega$ ‡ | 25°C | 15 | 35 | 15 | 35 | V/mV | |
| | | | Full range | 15 | | 15 | | | |
| | | $R_L = 1\text{ m}\Omega$ ‡ | 25°C | 175 | | 175 | | | |
| r_{id} Differential input resistance | | 25°C | 10^{12} | | | 10^{12} | Ω | | |
| r_i Common-mode input resistance | | 25°C | 10^{12} | | | 10^{12} | Ω | | |
| c_i Common-mode input capacitance | $f = 10\text{ kHz}$, N package | 25°C | 8 | | | 8 | pF | | |
| z_o Closed-loop output impedance | $f = 1\text{ MHz}$, $A_V = 10$ | 25°C | 140 | | | 140 | Ω | | |
| CMRR Common-mode rejection ratio | $V_{IC} = 0\text{ V to }2.7\text{ V}$, $V_O = 2.5\text{ V}$, $R_S = 50\ \Omega$ | 25°C | 70 | 75 | 70 | 75 | dB | | |
| | | Full range | 70 | | 70 | | | | |
| k_{SVR} Supply-voltage rejection ratio ($\Delta V_{DD}/\Delta V_{IO}$) | $V_{DD} = 4.4\text{ V to }16\text{ V}$, $V_{IC} = V_{DD}/2$, No load | 25°C | 80 | 95 | 80 | 95 | dB | | |
| | | Full range | 80 | | 80 | | | | |
| I_{DD} Supply current | $V_O = 2.5\text{ V}$, No load | 25°C | 4.4 | 6 | 4.4 | 6 | mA | | |
| | | Full range | 6 | | 6 | | | | |

† Full range is 0°C to 70°C.

‡ Referenced to 0 V

NOTE 4: Typical values are based on the input offset voltage shift observed through 168 hours of operating life test at $T_A = 150^\circ\text{C}$ extrapolated to $T_A = 25^\circ\text{C}$ using the Arrhenius equation and assuming an activation energy of 0.96 eV.



TLC227x, TLC227xA
Advanced LinCMOS™ RAIL-TO-RAIL
OPERATIONAL AMPLIFIERS

SLOS190G – FEBRUARY 1997 – REVISED MAY 2004

TLC2274C operating characteristics at specified free-air temperature, $V_{DD} = 5\text{ V}$

| PARAMETER | TEST CONDITIONS | T_A † | TLC2274C | | | TLC2274AC | | | UNIT |
|-------------|----------------------------------------------------------------------------------------------------------------------------------------|------------|----------------------------------------|-------------|-----|-----------|-----|------------------------|---------------|
| | | | MIN | TYP | MAX | MIN | TYP | MAX | |
| SR | Slew rate at unity gain $V_O = 0.5\text{ V to }2.5\text{ V}$, $R_L = 10\text{ k}\Omega$ ‡, $C_L = 100\text{ pF}$ ‡ | 25°C | 2.3 | 3.6 | | 2.3 | 3.6 | V/ μs | |
| | | Full range | 1.7 | | | 1.7 | | | |
| V_n | Equivalent input noise voltage $f = 10\text{ Hz}$ $f = 1\text{ kHz}$ | 25°C | | 50 | | | 50 | nV/ $\sqrt{\text{Hz}}$ | |
| | | 25°C | | 9 | | | 9 | | |
| $V_{N(PP)}$ | Peak-to-peak equivalent input noise voltage $f = 0.1\text{ Hz to }1\text{ Hz}$ $f = 0.1\text{ Hz to }10\text{ Hz}$ | 25°C | | 1 | | | 1 | μV | |
| | | 25°C | | 1.4 | | | 1.4 | | |
| I_n | Equivalent input noise current | 25°C | | 0.6 | | | 0.6 | fA/ $\sqrt{\text{Hz}}$ | |
| THD + N | Total harmonic distortion plus noise $V_O = 0.5\text{ V to }2.5\text{ V}$, $f = 20\text{ kHz}$, $R_L = 10\text{ k}\Omega$ ‡ | 25°C | | $A_V = 1$ | | 0.0013% | | 0.0013% | |
| | | | | $A_V = 10$ | | 0.004% | | 0.004% | |
| | | | | $A_V = 100$ | | 0.03% | | 0.03% | |
| | Gain-bandwidth product $f = 10\text{ kHz}$, $C_L = 100\text{ pF}$ ‡ | | $R_L = 10\text{ k}\Omega$ ‡ | 25°C | | 2.18 | | 2.18 | MHz |
| BOM | Maximum output-swing bandwidth $V_{O(PP)} = 2\text{ V}$, $R_L = 10\text{ k}\Omega$ ‡, $C_L = 100\text{ pF}$ ‡ | | $A_V = 1$, $C_L = 100\text{ pF}$ ‡ | 25°C | | 1 | | 1 | MHz |
| t_s | Settling time $A_V = -1$, Step = 0.5 V to 2.5 V, $R_L = 10\text{ k}\Omega$ ‡, $C_L = 100\text{ pF}$ ‡ | 25°C | | To 0.1% | | 1.5 | | 1.5 | μs |
| | | | | To 0.01% | | 2.6 | | 2.6 | |
| ϕ_m | Phase margin at unity gain $R_L = 10\text{ k}\Omega$ ‡, $C_L = 100\text{ pF}$ ‡ | 25°C | | 50° | | 50° | | | |
| | | 25°C | | 10 | | 10 | | dB | |

† Full range is 0°C to 70°C.

‡ Referenced to 0 V

TLC227x, TLC227xA Advanced LinCMOS™ RAIL-TO-RAIL OPERATIONAL AMPLIFIERS

SLOS190G – FEBRUARY 1997 – REVISED MAY 2004

TLC2274C electrical characteristics at specified free-air temperature, $V_{DD\pm} = \pm 5\text{ V}$ (unless otherwise noted)

| PARAMETER | TEST CONDITIONS | T_A † | TLC2274C | | | TLC2274AC | | | UNIT |
|-------------------------------------------------------------------------------|-----------------------------------------------------------------------------------------|---------------------------|--------------------------|-------------|-----------|-----------|-------------|---------------|------------------------------|
| | | | MIN | TYP | MAX | MIN | TYP | MAX | |
| V_{IO} Input offset voltage | $V_{IC} = 0\text{ V}, V_O = 0\text{ V}, R_S = 50\ \Omega$ | 25°C | 300 | 2500 | | 300 | 950 | μV | |
| | | Full range | | | 3000 | | 1500 | | |
| αV_{IO} Temperature coefficient of input offset voltage | | 25°C to 70°C | 2 | | | 2 | | | $\mu\text{V}/^\circ\text{C}$ |
| Input offset voltage long-term drift (see Note 4) | | 25°C | 0.002 | | | 0.002 | | | $\mu\text{V}/\text{mo}$ |
| I_{IO} Input offset current | | 25°C | 0.5 | 60 | | 0.5 | 60 | pA | |
| | | Full range | | | 100 | | 100 | | |
| I_{IB} Input bias current | 25°C | 1 | 60 | | 1 | 60 | pA | | |
| | Full range | | | 100 | | 100 | | | |
| V_{ICR} Common-mode input voltage | $R_S = 50\ \Omega, V_{IO} \leq 5\text{ mV}$ | 25°C | -5 to 4 | -5.3 to 4.2 | | -5 to 4 | -5.3 to 4.2 | V | |
| | | Full range | -5 to 3.5 | | | -5 to 3.5 | | | |
| V_{OM+} Maximum positive peak output voltage | $I_O = -20\ \mu\text{A}$ | 25°C | 4.99 | | 4.99 | | V | | |
| | | 25°C | 4.85 | 4.93 | 4.85 | 4.93 | | | |
| | | Full range | 4.85 | | 4.85 | | | | |
| | | 25°C | 4.25 | 4.65 | 4.25 | 4.65 | | | |
| V_{OM-} Maximum negative peak output voltage | $I_O = -1\text{ mA}$ | 25°C | -4.99 | | -4.99 | | V | | |
| | | 25°C | -4.85 | -4.91 | -4.85 | -4.91 | | | |
| | | Full range | -4.85 | | -4.85 | | | | |
| | | 25°C | -3.5 | -4.1 | -3.5 | -4.1 | | | |
| V_{IC-} Maximum negative peak output voltage | $V_{IC} = 0\text{ V}, I_O = 500\ \mu\text{A}$ | 25°C | -4.85 | -4.91 | | -4.85 | -4.91 | V | |
| | | Full range | -4.85 | | -4.85 | | | | |
| | | 25°C | -3.5 | -4.1 | -3.5 | -4.1 | | | |
| | | Full range | -3.5 | | -3.5 | | | | |
| A_{VD} Large-signal differential voltage amplification | $V_O = \pm 4\text{ V}$ | $R_L = 10\text{ k}\Omega$ | 25°C | 25 | 50 | 25 | 50 | V/mV | |
| | | | Full range | 25 | | 25 | | | |
| | | | $R_L = 1\text{ M}\Omega$ | 25°C | 300 | | 300 | | |
| r_{id} Differential input resistance | | 25°C | 10^{12} | | 10^{12} | | Ω | | |
| r_i Common-mode input resistance | | 25°C | 10^{12} | | 10^{12} | | Ω | | |
| c_i Common-mode input capacitance | $f = 10\text{ kHz}, \text{ N package}$ | 25°C | 8 | | 8 | | pF | | |
| z_o Closed-loop output impedance | $f = 1\text{ MHz}, A_V = 10$ | 25°C | 130 | | 130 | | Ω | | |
| CMRR Common-mode rejection ratio | $V_{IC} = -5\text{ V to } 2.7\text{ V}, V_O = 0\text{ V}, R_S = 50\ \Omega$ | 25°C | 75 | 80 | 75 | 80 | dB | | |
| | | Full range | 75 | | 75 | | | | |
| k_{SVR} Supply-voltage rejection ratio ($\Delta V_{DD\pm}/\Delta V_{IO}$) | $V_{DD\pm} = \pm 2.2\text{ V to } \pm 8\text{ V}, V_{IC} = 0\text{ V}, \text{ No load}$ | 25°C | 80 | 95 | 80 | 95 | dB | | |
| | | Full range | 80 | | 80 | | | | |
| I_{DD} Supply current | $V_O = 0\text{ V}, \text{ No load}$ | 25°C | 4.8 | 6 | 4.8 | 6 | mA | | |
| | | Full range | 6 | | 6 | | | | |

† Full range is 0°C to 70°C.

NOTE 4: Typical values are based on the input offset voltage shift observed through 168 hours of operating life test at $T_A = 150^\circ\text{C}$ extrapolated to $T_A = 25^\circ\text{C}$ using the Arrhenius equation and assuming an activation energy of 0.96 eV.



TLC227x, TLC227xA
Advanced LinCMOS™ RAIL-TO-RAIL
OPERATIONAL AMPLIFIERS

SLOS190G – FEBRUARY 1997 – REVISED MAY 2004

TLC2274C operating characteristics at specified free-air temperature, $V_{DD\pm} = \pm 5\text{ V}$

| PARAMETER | TEST CONDITIONS | T_A † | TLC2274C | | | TLC2274AC | | | UNIT |
|-------------|--------------------------------------------------------------------------------------------------------------------------|--------------------------------------------------------------------------------------------------------------------|--------------------------------------|-------------|---------|-----------|---------|------------------------|------------------|
| | | | MIN | TYP | MAX | MIN | TYP | MAX | |
| SR | Slew rate at unity gain $V_O = \pm 2.3\text{ V}$, $C_L = 100\text{ pF}$ | $R_L = 10\text{ k}\Omega$ | 25°C | 2.3 | 3.6 | | 2.3 | 3.6 | V/ μs |
| | | | Full range | 1.7 | | | 1.7 | | |
| V_n | Equivalent input noise voltage | | 25°C | | 50 | | 50 | nV/ $\sqrt{\text{Hz}}$ | |
| | | | 25°C | | 9 | | 9 | | |
| $V_{N(PP)}$ | Peak-to-peak equivalent input noise voltage | | 25°C | | 1 | | 1 | μV | |
| | | | 25°C | | 1.4 | | 1.4 | | |
| I_n | Equivalent input noise current | | 25°C | | 0.6 | | 0.6 | fA/ $\sqrt{\text{Hz}}$ | |
| THD + N | Total harmonic distortion plus noise $V_O = \pm 2.3\text{ V}$, $f = 20\text{ kHz}$, $R_L = 10\text{ k}\Omega$ | | 25°C | $A_V = 1$ | 0.0011% | | 0.0011% | | |
| | | | | $A_V = 10$ | 0.004% | | 0.004% | | |
| | | | | $A_V = 100$ | 0.03% | | 0.03% | | |
| | Gain-bandwidth product | $f = 10\text{ kHz}$, $C_L = 100\text{ pF}$ | $R_L = 10\text{ k}\Omega$ | 25°C | | 2.25 | | 2.25 | MHz |
| BOM | Maximum output-swing bandwidth | $V_{O(PP)} = 4.6\text{ V}$, $R_L = 10\text{ k}\Omega$ | $A_V = 1$, $C_L = 100\text{ pF}$ | 25°C | | 0.54 | | 0.54 | MHz |
| t_s | Settling time | $A_V = -1$, Step = -2.3 V to 2.3 V , $R_L = 10\text{ k}\Omega$, $C_L = 100\text{ pF}$ | 25°C | To 0.1% | | 1.5 | | 1.5 | μs |
| | | | | To 0.01% | | 3.2 | | 3.2 | |
| ϕ_m | Phase margin at unity gain | $R_L = 10\text{ k}\Omega$, $C_L = 100\text{ pF}$ | 25°C | | 52° | | 52° | | |
| | Gain margin | | 25°C | | 10 | | 10 | dB | |

† Full range is 0°C to 70°C.

TLC227x, TLC227xA Advanced LinCMOS™ RAIL-TO-RAIL OPERATIONAL AMPLIFIERS

SLOS190G – FEBRUARY 1997 – REVISED MAY 2004

TLC2272I electrical characteristics at specified free-air temperature, $V_{DD} = 5\text{ V}$ (unless otherwise noted)

| PARAMETER | TEST CONDITIONS | T_A † | TLC2272I | | | TLC2272AI | | | UNIT |
|----------------------------------------------------------------------------|-------------------------------------------------------------------------------------------------------------------------------------------------------------------------|------------------------------------|------------|-------------|------|-----------|-------------|---------------|------------------------------|
| | | | MIN | TYP | MAX | MIN | TYP | MAX | |
| V_{IO} Input offset voltage | | 25°C | 300 | 2500 | | 300 | 950 | μV | |
| | | Full range | | | 3000 | | 1500 | | |
| α_{VIO} Temperature coefficient of input offset voltage | | 25°C to 85°C | 2 | | | 2 | | | $\mu\text{V}/^\circ\text{C}$ |
| Input offset voltage long-term drift (see Note 4) | $V_{IC} = 0\text{ V},$ $V_O = 0\text{ V},$ $V_{DD\pm} = \pm 2.5\text{ V}$ $R_S = 50\ \Omega$ | 25°C | 0.002 | | | 0.002 | | | $\mu\text{V}/\text{mo}$ |
| I_{IO} Input offset current | | 25°C | 0.5 | 60 | | 0.5 | 60 | pA | |
| | -40°C to 85°C | 150 | | | 150 | | | | |
| | Full range | 800 | | | 800 | | | | |
| I_{IB} Input bias current | | 25°C | 1 | 60 | | 1 | 60 | pA | |
| | | -40°C to 85°C | 150 | | | 150 | | | |
| | | Full range | 800 | | | 800 | | | |
| V_{ICR} Common-mode input voltage | $R_S = 50\ \Omega,$ $ V_{IO} \leq 5\text{ mV}$ | 25°C | 0 to 4 | -0.3 to 4.2 | | 0 to 4 | -0.3 to 4.2 | V | |
| | | Full range | 0 to 3.5 | | | 0 to 3.5 | | | |
| V_{OH} High-level output voltage | $I_{OH} = -20\ \mu\text{A}$ $I_{OH} = -200\ \mu\text{A}$ $I_{OH} = -1\text{ mA}$ | 25°C | 4.99 | | | 4.99 | | | V |
| | | 25°C | 4.85 | 4.93 | | 4.85 | 4.93 | | |
| | | Full range | 4.85 | | | 4.85 | | | |
| | | 25°C | 4.25 | 4.65 | | 4.25 | 4.65 | | |
| V_{OL} Low-level output voltage | $V_{IC} = 2.5\text{ V},$ $I_{OL} = 50\ \mu\text{A}$ $V_{IC} = 2.5\text{ V},$ $I_{OL} = 500\ \mu\text{A}$ $V_{IC} = 2.5\text{ V},$ $I_{OL} = 5\text{ mA}$ | 25°C | 0.01 | | | 0.01 | | | V |
| | | 25°C | 0.09 | 0.15 | | 0.09 | 0.15 | | |
| | | Full range | 0.15 | | | 0.15 | | | |
| | | 25°C | 0.9 | 1.5 | | 0.9 | 1.5 | | |
| A_{VD} Large-signal differential voltage amplification | $V_{IC} = 2.5\text{ V},$ $V_O = 1\text{ V to }4\text{ V}$ | $R_L = 10\text{ k}\Omega^\ddagger$ | 25°C | 15 | 35 | | 15 | 35 | V/mV |
| | | | Full range | 15 | | | 15 | | |
| | | $R_L = 1\text{ m}\Omega^\ddagger$ | 25°C | 175 | | | 175 | | |
| r_{id} Differential input resistance | | 25°C | 10^{12} | | | 10^{12} | | | Ω |
| r_i Common-mode input resistance | | 25°C | 10^{12} | | | 10^{12} | | | Ω |
| C_i Common-mode input capacitance | $f = 10\text{ kHz},$ P package | 25°C | 8 | | | 8 | | | pF |
| Z_o Closed-loop output impedance | $f = 1\text{ MHz},$ $A_V = 10$ | 25°C | 140 | | | 140 | | | Ω |
| CMRR Common-mode rejection ratio | $V_{IC} = 0\text{ V to }2.7\text{ V},$ $V_O = 2.5\text{ V},$ $R_S = 50\ \Omega$ | 25°C | 70 | 75 | | 70 | 75 | dB | |
| | | Full range | 70 | | | 70 | | | |
| k_{SVR} Supply-voltage rejection ratio ($\Delta V_{DD}/\Delta V_{IO}$) | $V_{DD} = 4.4\text{ V to }16\text{ V},$ $V_{IC} = V_{DD}/2,$ No load | 25°C | 80 | 95 | | 80 | 95 | dB | |
| | | Full range | 80 | | | 80 | | | |
| I_{DD} Supply current | $V_O = 2.5\text{ V},$ No load | 25°C | 2.2 | 3 | | 2.2 | 3 | mA | |
| | | Full range | 3 | | | 3 | | | |

† Full range is -40°C to 125°C.

‡ Referenced to 0 V

NOTE 4: Typical values are based on the input offset voltage shift observed through 168 hours of operating life test at $T_A = 150^\circ\text{C}$ extrapolated to $T_A = 25^\circ\text{C}$ using the Arrhenius equation and assuming an activation energy of 0.96 eV.



TLC227x, TLC227xA
Advanced LinCMOS™ RAIL-TO-RAIL
OPERATIONAL AMPLIFIERS

SLOS190G – FEBRUARY 1997 – REVISED MAY 2004

TLC2272I operating characteristics at specified free-air temperature, $V_{DD} = 5\text{ V}$

| PARAMETER | TEST CONDITIONS | T_A † | TLC2272I | | | TLC2272AI | | | UNIT |
|-----------|------------------------------------------------------------------------------------------------------------------------------|---------------------------------------------------------------------------------------------------|----------|------|---------|-----------|---------|-----------------------|-----------------------|
| | | | MIN | TYP | MAX | MIN | TYP | MAX | |
| SR | Slew rate at unity gain $V_O = 0.5\text{ V to }2.5\text{ V}$, $R_L = 10\text{ k}\Omega$ ‡, $C_L = 100\text{ pF}$ ‡ | 25°C | 2.3 | 3.6 | | 2.3 | 3.6 | | V/ μs |
| | | Full range | 1.7 | | | 1.7 | | | |
| V_n | Equivalent input noise voltage | f = 10 Hz | | 50 | | | 50 | | nV $\sqrt{\text{Hz}}$ |
| | | f = 1 kHz | 25°C | | 9 | | 9 | | |
| V_{NPP} | Peak-to-peak equivalent input noise voltage | f = 0.1 Hz to 1 Hz | 25°C | | 1 | | 1 | | μV |
| | | f = 0.1 Hz to 10 Hz | 25°C | | 1.4 | | 1.4 | | |
| I_n | Equivalent input noise current | 25°C | | 0.6 | | | 0.6 | fA $\sqrt{\text{Hz}}$ | |
| THD + N | Total harmonic distortion plus noise $V_O = 0.5\text{ V to }2.5\text{ V}$, f = 20 kHz, $R_L = 10\text{ k}\Omega$ ‡ | $A_V = 1$ | 25°C | | 0.0013% | | 0.0013% | | |
| | | $A_V = 10$ | | | 0.004% | | 0.004% | | |
| | | $A_V = 100$ | | | 0.03% | | 0.03% | | |
| | Gain-bandwidth product | f = 10 kHz, $R_L = 10\text{ k}\Omega$ ‡, $C_L = 100\text{ pF}$ ‡ | 25°C | | 2.18 | | 2.18 | | MHz |
| BOM | Maximum output-swing bandwidth | $V_{O(PP)} = 2\text{ V}$, $R_L = 10\text{ k}\Omega$ ‡, $A_V = 1$, $C_L = 100\text{ pF}$ ‡ | 25°C | | 1 | | 1 | | MHz |
| t_s | Settling time | $A_V = -1$, Step = 0.5 V to 2.5 V, $R_L = 10\text{ k}\Omega$ ‡, $C_L = 100\text{ pF}$ ‡ | To 0.1% | 25°C | | 1.5 | | 1.5 | μs |
| | | | To 0.01% | | | 2.6 | | 2.6 | |
| ϕ_m | Phase margin at unity gain | $R_L = 10\text{ k}\Omega$ ‡, $C_L = 100\text{ pF}$ ‡ | 25°C | | 50° | | 50° | | |
| | Gain margin | | 25°C | | 10 | | 10 | | dB |

† Full range is – 40°C to 125°C.

‡ Referenced to 0 V

TLC227x, TLC227xA

Advanced LinCMOS™ RAIL-TO-RAIL OPERATIONAL AMPLIFIERS

SLOS190G – FEBRUARY 1997 – REVISED MAY 2004

TLC2272I electrical characteristics at specified free-air temperature, $V_{DD\pm} = \pm 5\text{ V}$ (unless otherwise noted)

| PARAMETER | TEST CONDITIONS | T_A^\dagger | TLC2272I | | | TLC2272AI | | | UNIT | |
|-------------------------------------------------------------------------------|------------------------------------------------------------------|-----------------------------|---------------|---------|-------------|-----------|-----------|------------------------------|---------------|-------|
| | | | MIN | TYP | MAX | MIN | TYP | MAX | | |
| V_{IO} Input offset voltage | | 25°C | | 300 | 2500 | | 300 | 950 | μV | |
| | | Full range | | | 3000 | | | 1500 | | |
| α_{VIO} Temperature coefficient of input offset voltage | | 25°C to 85°C | | 2 | | | 2 | $\mu\text{V}/^\circ\text{C}$ | | |
| Input offset voltage long-term drift (see Note 4) | $V_{IC} = 0\text{ V},$ $R_S = 50\ \Omega$ | $V_O = 0\text{ V},$ | 25°C | | 0.002 | | 0.002 | $\mu\text{V}/\text{mo}$ | | |
| I_{IO} Input offset current | | | 25°C | | 0.5 | 60 | | 0.5 | 60 | pA |
| | -40°C to 85°C | | | 150 | | | 150 | | | |
| | Full range | | | 800 | | | 800 | | | |
| I_{IB} Input bias current | | | 25°C | | 1 | | 1 | 60 | pA | |
| | | | -40°C to 85°C | | | 150 | | | | 150 |
| | | | Full range | | | 800 | | | | 800 |
| V_{ICR} Common-mode input voltage | $R_S = 50\ \Omega,$ | $ V_{IO} \leq 5\text{ mV}$ | 25°C | -5 to 4 | -5.3 to 4.2 | | -5 to 4 | -5.3 to 4.2 | V | |
| | | | Full range | | -5 to 3.5 | | -5 to 3.5 | | | |
| V_{OM+} Maximum positive peak output voltage | $I_O = -20\ \mu\text{A}$ | | 25°C | | 4.99 | | | 4.99 | V | |
| | | | 25°C | | 4.85 | 4.93 | | 4.85 | | 4.93 |
| | | | Full range | | 4.85 | | | 4.85 | | |
| | | | 25°C | | 4.25 | 4.65 | | 4.25 | | 4.65 |
| V_{OM-} Maximum negative peak output voltage | $I_O = -1\text{ mA}$ | | 25°C | | -4.99 | | | -4.99 | V | |
| | | | 25°C | | -4.85 | -4.91 | | -4.85 | | -4.91 |
| | | | Full range | | -4.85 | | | -4.85 | | |
| | | | 25°C | | -3.5 | -4.1 | | -3.5 | | -4.1 |
| V_{OM-} Maximum negative peak output voltage | $V_{IC} = 0\text{ V},$ | $I_O = 50\ \mu\text{A}$ | 25°C | | -4.99 | | | -4.99 | V | |
| | | | 25°C | | -4.85 | -4.91 | | -4.85 | | -4.91 |
| | | | Full range | | -4.85 | | | -4.85 | | |
| | | | 25°C | | -3.5 | -4.1 | | -3.5 | | -4.1 |
| V_{OM-} Maximum negative peak output voltage | $V_{IC} = 0\text{ V},$ | $I_O = 500\ \mu\text{A}$ | 25°C | | -4.99 | | | -4.99 | V | |
| | | | 25°C | | -4.85 | -4.91 | | -4.85 | | -4.91 |
| | | | Full range | | -4.85 | | | -4.85 | | |
| | | | 25°C | | -3.5 | -4.1 | | -3.5 | | -4.1 |
| V_{OM-} Maximum negative peak output voltage | $V_{IC} = 0\text{ V},$ | $I_O = 5\text{ mA}$ | 25°C | | -4.99 | | | -4.99 | V | |
| | | | 25°C | | -4.85 | -4.91 | | -4.85 | | -4.91 |
| | | | Full range | | -4.85 | | | -4.85 | | |
| | | | 25°C | | -3.5 | -4.1 | | -3.5 | | -4.1 |
| A_{VD} Large-signal differential voltage amplification | $V_O = \pm 4\text{ V}$ | $R_L = 10\text{ k}\Omega$ | 25°C | | 25 | 50 | | 25 | 50 | V/mV |
| | | | Full range | | 25 | | | 25 | | |
| | | | 25°C | | | 300 | | | 300 | |
| r_{id} Differential input resistance | | | 25°C | | 10^{12} | | 10^{12} | Ω | | |
| r_i Common-mode input resistance | | | 25°C | | 10^{12} | | 10^{12} | Ω | | |
| c_i Common-mode input capacitance | $f = 10\text{ kHz},$ | P package | 25°C | | 8 | | 8 | pF | | |
| z_o Closed-loop output impedance | $f = 1\text{ MHz},$ | $A_V = 10$ | 25°C | | 130 | | 130 | Ω | | |
| CMRR Common-mode rejection ratio | $V_{IC} = -5\text{ V to } 2.7\text{ V},$ $V_O = 0\text{ V},$ | $R_S = 50\ \Omega$ | 25°C | | 75 | 80 | | 75 | 80 | dB |
| | | | Full range | | 75 | | | 75 | | |
| k_{SVR} Supply-voltage rejection ratio ($\Delta V_{DD\pm}/\Delta V_{IO}$) | $V_{DD} = 4.4\text{ V to } 16\text{ V},$ $V_{IC} = V_{DD}/2,$ | No load | 25°C | | 80 | 95 | | 80 | 95 | dB |
| | | | Full range | | 80 | | | 80 | | |
| I_{DD} Supply current | $V_O = 0\text{ V},$ | No load | 25°C | | 2.4 | 3 | | 2.4 | 3 | mA |
| | | | Full range | | | 3 | | | 3 | |

† Full range is -40°C to 125°C.

NOTE 4: Typical values are based on the input offset voltage shift observed through 168 hours of operating life test at $T_A = 150^\circ\text{C}$ extrapolated to $T_A = 25^\circ\text{C}$ using the Arrhenius equation and assuming an activation energy of 0.96 eV.



TLC227x, TLC227xA
Advanced LinCMOS™ RAIL-TO-RAIL
OPERATIONAL AMPLIFIERS

SLOS190G – FEBRUARY 1997 – REVISED MAY 2004

TLC2272I operating characteristics at specified free-air temperature, $V_{DD\pm} = \pm 5\text{ V}$

| PARAMETER | TEST CONDITIONS | T_A † | TLC2272I | | | TLC2272AI | | | UNIT |
|-----------|---------------------------------------------------------------------------------------------------------------------------------------|------------|-------------|------|---------|-----------|---------|-----|-----------------------|
| | | | MIN | TYP | MAX | MIN | TYP | MAX | |
| SR | Slew rate at unity gain $V_O = \pm 2.3\text{ V}$, $C_L = 100\text{ pF}$, $R_L = 10\text{ k}\Omega$ | 25°C | 2.3 | 3.6 | | 2.3 | 3.6 | | V/ μs |
| | | Full range | 1.7 | | | 1.7 | | | |
| V_n | Equivalent input noise voltage $f = 10\text{ Hz}$ $f = 1\text{ kHz}$ | 25°C | | 50 | | | 50 | | nV $\sqrt{\text{Hz}}$ |
| | | 25°C | | 9 | | | 9 | | |
| V_{NPP} | Peak-to-peak equivalent input noise voltage $f = 0.1\text{ Hz to }1\text{ Hz}$ $f = 0.1\text{ Hz to }10\text{ Hz}$ | 25°C | | 1 | | | 1 | | μV |
| | | 25°C | | 1.4 | | | 1.4 | | |
| I_n | Equivalent input noise current | 25°C | | 0.6 | | | 0.6 | | fA $\sqrt{\text{Hz}}$ |
| THD + N | Total harmonic distortion plus noise $V_O = \pm 2.3\text{ V}$ $R_L = 10\text{ k}\Omega$, $f = 20\text{ kHz}$ | 25°C | $A_V = 1$ | | 0.0011% | | 0.0011% | | |
| | | | $A_V = 10$ | | 0.004% | | 0.004% | | |
| | | | $A_V = 100$ | | 0.03% | | 0.03% | | |
| | Gain-bandwidth product $f = 10\text{ kHz}$, $C_L = 100\text{ pF}$, $R_L = 10\text{ k}\Omega$ | 25°C | | 2.25 | | | 2.25 | | MHz |
| B_{OM} | Maximum output-swing bandwidth $V_{O(PP)} = 4.6\text{ V}$, $R_L = 10\text{ k}\Omega$, $A_V = 1$, $C_L = 100\text{ pF}$ | 25°C | | 0.54 | | | 0.54 | | MHz |
| t_s | Settling time $A_V = -1$, Step = $-2.3\text{ V to }2.3\text{ V}$, $R_L = 10\text{ k}\Omega$, $C_L = 100\text{ pF}$ | 25°C | To 0.1% | | 1.5 | | 1.5 | | μs |
| | | | To 0.01% | | 3.2 | | 3.2 | | |
| ϕ_m | Phase margin at unity gain $R_L = 10\text{ k}\Omega$, $C_L = 100\text{ pF}$ | 25°C | | 52° | | | 52° | | |
| | | 25°C | | 10 | | | 10 | | |
| | Gain margin | 25°C | | 10 | | | 10 | | dB |

† Full range is -40°C to 125°C .

TLC227x, TLC227xA

Advanced LinCMOS™ RAIL-TO-RAIL OPERATIONAL AMPLIFIERS

SLOS190G – FEBRUARY 1997 – REVISED MAY 2004

TLC2274I electrical characteristics at specified free-air temperature, $V_{DD} = 5\text{ V}$ (unless otherwise noted)

| PARAMETER | TEST CONDITIONS | T_A † | TLC2274I | | | TLC2274AI | | | UNIT |
|------------------------------------------------------------------------------|-------------------------------------------------------------------------------------------------------------------------------------------------------------------|---------------|------------------------------------|-------------|-------|-----------|-------------|---------------|------------------------------|
| | | | MIN | TYP | MAX | MIN | TYP | MAX | |
| V_{IO} Input offset voltage | $V_{DD\pm} = \pm 2.5\text{ V}$, $V_{IC} = 0\text{ V}$, $V_O = 0\text{ V}$, $R_S = 50\ \Omega$ | 25°C | 300 | 2500 | | 300 | 950 | μV | |
| | | Full range | | | 3000 | | 1500 | | |
| α_{VIO} Temperature coefficient of input offset voltage | | 25°C to 85°C | 2 | | | 2 | | | $\mu\text{V}/^\circ\text{C}$ |
| Input offset voltage long-term drift (see Note 4) | | 25°C | 0.002 | | | 0.002 | | | $\mu\text{V}/\text{mo}$ |
| I_{IO} Input offset current | | 25°C | 0.5 | 60 | | 0.5 | 60 | pA | |
| | | -40°C to 85°C | 150 | | | 150 | | | |
| | Full range | 800 | | | 800 | | | | |
| I_{IB} Input bias current | 25°C | 1 | 60 | | 1 | 60 | pA | | |
| | -40°C to 85°C | 150 | | | 150 | | | | |
| | Full range | 800 | | | 800 | | | | |
| V_{ICR} Common-mode input voltage | $R_S = 50\ \Omega$, $ V_{IO} \leq 5\text{ mV}$ | 25°C | 0 to 4 | -0.3 to 4.2 | | 0 to 4 | -0.3 to 4.2 | V | |
| | | Full range | 0 to 3.5 | | | 0 to 3.5 | | | |
| V_{OH} High-level output voltage | $I_{OH} = -20\ \mu\text{A}$ $I_{OH} = -200\ \mu\text{A}$ $I_{OH} = -1\text{ mA}$ | 25°C | 4.99 | | 4.99 | | V | | |
| | | 25°C | 4.85 | 4.93 | 4.85 | 4.93 | | | |
| | | Full range | 4.85 | | 4.85 | | | | |
| | | 25°C | 4.25 | 4.65 | 4.25 | 4.65 | | | |
| V_{OL} Low-level output voltage | $V_{IC} = 2.5\text{ V}$, $I_{OL} = 50\ \mu\text{A}$ $V_{IC} = 2.5\text{ V}$, $I_{OL} = 500\ \mu\text{A}$ $V_{IC} = 2.5\text{ V}$, $I_{OL} = 5\text{ mA}$ | 25°C | 0.01 | | 0.01 | | V | | |
| | | 25°C | 0.09 | 0.15 | 0.09 | 0.15 | | | |
| | | Full range | 0.15 | | 0.15 | | | | |
| | | 25°C | 0.9 | 1.5 | 0.9 | 1.5 | | | |
| A_{VD} Large-signal differential voltage amplification | $V_{IC} = 2.5\text{ V}$, $V_O = 1\text{ V to }4\text{ V}$ | 25°C | $R_L = 10\text{ k}\Omega^\ddagger$ | | 15 35 | | V/mV | | |
| | | | Full range | | 15 | | | | |
| | | 25°C | $R_L = 1\text{ M}\Omega^\ddagger$ | | 175 | | | | |
| r_{id} Differential input resistance | | 25°C | 10^{12} | | | 10^{12} | Ω | | |
| r_i Common-mode input resistance | | 25°C | 10^{12} | | | 10^{12} | Ω | | |
| C_i Common-mode input capacitance | $f = 10\text{ kHz}$, N package | 25°C | 8 | | | 8 | pF | | |
| Z_o Closed-loop output impedance | $f = 1\text{ MHz}$, $A_V = 10$ | 25°C | 140 | | | 140 | Ω | | |
| CMRR Common-mode rejection ratio | $V_{IC} = 0\text{ V to }2.7\text{ V}$, $V_O = 2.5\text{ V}$, $R_S = 50\ \Omega$ | 25°C | 70 | 75 | | 70 | 75 | dB | |
| | | Full range | 70 | | | 70 | | | |
| k_{SVR} Supply-voltage rejection ratio ($\Delta V_{DD} / \Delta V_{IO}$) | $V_{DD} = 4.4\text{ V to }16\text{ V}$, $V_{IC} = V_{DD}/2$, No load | 25°C | 80 | 95 | | 80 | 95 | dB | |
| | | Full range | 80 | | | 80 | | | |
| I_{DD} Supply current | $V_O = 2.5\text{ V}$, No load | 25°C | 4.4 | 6 | | 4.4 | 6 | mA | |
| | | Full range | 6 | | | 6 | | | |

† Full range is -40°C to 125°C.

‡ Referenced to 0 V

NOTE 4: Typical values are based on the input offset voltage shift observed through 168 hours of operating life test at $T_A = 150^\circ\text{C}$ extrapolated to $T_A = 25^\circ\text{C}$ using the Arrhenius equation and assuming an activation energy of 0.96 eV.



TLC227x, TLC227xA
Advanced LinCMOS™ RAIL-TO-RAIL
OPERATIONAL AMPLIFIERS

SLOS190G – FEBRUARY 1997 – REVISED MAY 2004

TLC2274I operating characteristics at specified free-air temperature, $V_{DD} = 5\text{ V}$

| PARAMETER | TEST CONDITIONS | T_A † | TLC2274I | | | TLC2274AI | | | UNIT |
|-------------|-------------------------------------------------------------------------------------------------------------------------------------------------|---------------------|----------|---------|--------|-----------|---------|------------------------|------|
| | | | MIN | TYP | MAX | MIN | TYP | MAX | |
| SR | Slew rate at unity gain $V_O = 0.5\text{ V to }2.5\text{ V}$, $R_L = 10\text{ k}\Omega^\ddagger$, $C_L = 100\text{ pF}^\ddagger$ | 25°C | 2.3 | 3.6 | | 2.3 | 3.6 | V/ μs | |
| | | Full range | 1.7 | | | 1.7 | | | |
| V_n | Equivalent input noise voltage | f = 10 Hz | | 50 | | | 50 | nV/ $\sqrt{\text{Hz}}$ | |
| | | f = 1 kHz | | 9 | | | 9 | | |
| $V_{N(PP)}$ | Peak-to-peak equivalent input noise voltage | f = 0.1 Hz to 1 Hz | | 1 | | | 1 | μV | |
| | | f = 0.1 Hz to 10 Hz | | 1.4 | | | 1.4 | | |
| I_n | Equivalent input noise current | 25°C | | 0.6 | | | 0.6 | fA/ $\sqrt{\text{Hz}}$ | |
| THD + N | Total harmonic distortion plus noise $V_O = 0.5\text{ V to }2.5\text{ V}$, f = 20 kHz, $R_L = 10\text{ k}\Omega^\ddagger$ | $A_V = 1$ | | 0.0013% | | | 0.0013% | | |
| | | $A_V = 10$ | 25°C | | 0.004% | | 0.004% | | |
| | | $A_V = 100$ | | | 0.03% | | 0.03% | | |
| | Gain-bandwidth product f = 10 kHz, $R_L = 10\text{ k}\Omega^\ddagger$, $C_L = 100\text{ pF}^\ddagger$ | 25°C | | 2.18 | | | 2.18 | MHz | |
| BOM | Maximum output-swing bandwidth $V_{O(PP)} = 2\text{ V}$, $A_V = 1$, $R_L = 10\text{ k}\Omega^\ddagger$, $C_L = 100\text{ pF}^\ddagger$ | 25°C | | 1 | | | 1 | MHz | |
| t_s | Settling time $A_V = -1$, Step = 0.5 V to 2.5 V, $R_L = 10\text{ k}\Omega^\ddagger$, $C_L = 100\text{ pF}^\ddagger$ | To 0.1% | | 1.5 | | | 1.5 | μs | |
| | | To 0.01% | 25°C | | 2.6 | | 2.6 | | |
| ϕ_m | Phase margin at unity gain $R_L = 10\text{ k}\Omega^\ddagger$, $C_L = 100\text{ pF}^\ddagger$ | 25°C | | 50° | | | 50° | | |
| | Gain margin | 25°C | | 10 | | | 10 | dB | |

† Full range is – 40°C to 125°C.

‡ Referenced to 0 V

TLC227x, TLC227xA Advanced LinCMOS™ RAIL-TO-RAIL OPERATIONAL AMPLIFIERS

SLOS190G – FEBRUARY 1997 – REVISED MAY 2004

TLC2274I electrical characteristics at specified free-air temperature, $V_{DD\pm} = \pm 5\text{ V}$ (unless otherwise noted)

| PARAMETER | TEST CONDITIONS | T_A † | TLC2274I | | | TLC2274AI | | | UNIT |
|-------------------------------------------------------------------------------|-----------------------------------------------------------------------------------------|---------------------------|------------|-------------|-----------|-----------|-------------|---------------|------------------------------|
| | | | MIN | TYP | MAX | MIN | TYP | MAX | |
| V_{IO} Input offset voltage | $V_{IC} = 0\text{ V}, V_O = 0\text{ V}, R_S = 50\ \Omega$ | 25°C | 300 | 2500 | | 300 | 950 | μV | |
| | | Full range | | | 3000 | | 1500 | | |
| α_{VIO} Temperature coefficient of input offset voltage | | 25°C to 85°C | 2 | | | 2 | | | $\mu\text{V}/^\circ\text{C}$ |
| Input offset voltage long-term drift (see Note 4) | | 25°C | 0.002 | | | 0.002 | | | $\mu\text{V}/\text{mo}$ |
| I_{IO} Input offset current | | 25°C | 0.5 | 60 | | 0.5 | 60 | pA | |
| | | -40°C to 85°C | 150 | | | 150 | | | |
| | | Full range | 800 | | | 800 | | | |
| I_{IB} Input bias current | | 25°C | 1 | 60 | | 1 | 60 | pA | |
| | | -40°C to 85°C | 150 | | | 150 | | | |
| | | Full range | 800 | | | 800 | | | |
| V_{ICR} Common-mode input voltage | $R_S = 50\ \Omega, V_{IO} \leq 5\text{ mV}$ | 25°C | -5 to 4 | -5.3 to 4.2 | | -5 to 4 | -5.3 to 4.2 | V | |
| | | Full range | -5 to 3.5 | | -5 to 3.5 | | | | |
| V_{OM+} Maximum positive peak output voltage | $I_O = -20\ \mu\text{A}$ | 25°C | 4.99 | | 4.99 | | V | | |
| | | Full range | 4.85 | | 4.85 | | | | |
| | $I_O = -200\ \mu\text{A}$ | 25°C | 4.85 | 4.93 | | 4.85 | | 4.93 | |
| | | Full range | 4.85 | | 4.85 | | | | |
| $I_O = -1\text{ mA}$ | 25°C | 4.25 | 4.65 | | 4.25 | 4.65 | | | |
| | Full range | 4.25 | | 4.25 | | | | | |
| V_{OM-} Maximum negative peak output voltage | $V_{IC} = 0\text{ V}, I_O = 50\ \mu\text{A}$ | 25°C | -4.99 | | -4.99 | | V | | |
| | | Full range | -4.85 | | -4.85 | | | | |
| | $V_{IC} = 0\text{ V}, I_O = 500\ \mu\text{A}$ | 25°C | -4.85 | -4.91 | | -4.85 | | -4.91 | |
| | | Full range | -4.85 | | -4.85 | | | | |
| $V_{IC} = 0\text{ V}, I_O = 5\text{ mA}$ | 25°C | -3.5 | -4.1 | | -3.5 | -4.1 | | | |
| | Full range | -3.5 | | -3.5 | | | | | |
| A_{VD} Large-signal differential voltage amplification | $V_O = \pm 4\text{ V}$ | $R_L = 10\text{ k}\Omega$ | 25°C | 25 | 50 | | 25 | 50 | V/mV |
| | | | Full range | 25 | | 25 | | | |
| | | $R_L = 1\text{ M}\Omega$ | 25°C | 300 | | | 300 | | |
| r_{id} Differential input resistance | | 25°C | 10^{12} | | | 10^{12} | | Ω | |
| r_i Common-mode input resistance | | 25°C | 10^{12} | | | 10^{12} | | Ω | |
| c_i Common-mode input capacitance | $f = 10\text{ kHz}, \text{ N package}$ | 25°C | 8 | | | 8 | | pF | |
| z_o Closed-loop output impedance | $f = 1\text{ MHz}, A_V = 10$ | 25°C | 130 | | | 130 | | Ω | |
| CMRR Common-mode rejection ratio | $V_{IC} = -5\text{ V to } 2.7\text{ V}, V_O = 0\text{ V}, R_S = 50\ \Omega$ | 25°C | 75 | 80 | | 75 | 80 | dB | |
| | | Full range | 75 | | 75 | | | | |
| k_{SVR} Supply-voltage rejection ratio ($\Delta V_{DD\pm}/\Delta V_{IO}$) | $V_{DD\pm} = \pm 2.2\text{ V to } \pm 8\text{ V}, V_{IC} = 0\text{ V}, \text{ No load}$ | 25°C | 80 | 95 | | 80 | 95 | dB | |
| | | Full range | 80 | | 80 | | | | |
| I_{DD} Supply current | $V_O = 0\text{ V}, \text{ No load}$ | 25°C | 4.8 | 6 | | 4.8 | 6 | mA | |
| | | Full range | 6 | | 6 | | | | |

† Full range is -40°C to 125°C.

NOTE 4: Typical values are based on the input offset voltage shift observed through 168 hours of operating life test at $T_A = 150^\circ\text{C}$ extrapolated to $T_A = 25^\circ\text{C}$ using the Arrhenius equation and assuming an activation energy of 0.96 eV.



TLC227x, TLC227xA
Advanced LinCMOS™ RAIL-TO-RAIL
OPERATIONAL AMPLIFIERS

SLOS190G – FEBRUARY 1997 – REVISED MAY 2004

TLC2274I operating characteristics at specified free-air temperature, $V_{DD\pm} = \pm 5\text{ V}$

| PARAMETER | TEST CONDITIONS | T_A † | TLC2274I | | | TLC2274AI | | | UNIT |
|-------------|---------------------------------------------------------------------------------------------------------------------------------------|---------------------|----------|---------|-----|-----------|------|------------------------|------------------------|
| | | | MIN | TYP | MAX | MIN | TYP | MAX | |
| SR | Slew rate at unity gain $V_O = \pm 2.3\text{ V}$, $C_L = 100\text{ pF}$, $R_L = 10\text{ k}\Omega$ | 25°C | 2.3 | 3.6 | | 2.3 | 3.6 | | V/ μs |
| | | Full range | 1.7 | | | 1.7 | | | |
| V_n | Equivalent input noise voltage | f = 10 Hz | | 50 | | | 50 | | nV/ $\sqrt{\text{Hz}}$ |
| | | f = 1 kHz | | 9 | | | 9 | | |
| $V_{N(PP)}$ | Peak-to-peak equivalent input noise voltage | f = 0.1 Hz to 1 Hz | | 1 | | | 1 | | μV |
| | | f = 0.1 Hz to 10 Hz | | 1.4 | | | 1.4 | | |
| I_n | Equivalent input noise current | 25°C | | 0.6 | | | 0.6 | fA/ $\sqrt{\text{Hz}}$ | |
| THD + N | Total harmonic distortion plus noise $V_O = \pm 2.3\text{ V}$, $R_L = 10\text{ k}\Omega$, f = 20 kHz | $A_V = 1$ | 25°C | 0.0011% | | 0.0011% | | | |
| | | $A_V = 10$ | | 0.004% | | 0.004% | | | |
| | | $A_V = 100$ | | 0.03% | | 0.03% | | | |
| | Gain-bandwidth product f = 10 kHz, $C_L = 100\text{ pF}$, $R_L = 10\text{ k}\Omega$ | 25°C | | 2.25 | | | 2.25 | MHz | |
| BOM | Maximum output-swing bandwidth $V_{O(PP)} = 4.6\text{ V}$, $R_L = 10\text{ k}\Omega$, $A_V = 1$, $C_L = 100\text{ pF}$ | 25°C | | 0.54 | | | 0.54 | MHz | |
| t_s | Settling time $A_V = -1$, Step = -2.3 V to 2.3 V, $R_L = 10\text{ k}\Omega$, $C_L = 100\text{ pF}$ | To 0.1% | 25°C | 1.5 | | 1.5 | | μs | |
| | | To 0.01% | | 3.2 | | 3.2 | | | |
| ϕ_m | Phase margin at unity gain $R_L = 10\text{ k}\Omega$, $C_L = 100\text{ pF}$ | 25°C | | 52° | | | 52° | | |
| | | 25°C | | 10 | | | 10 | dB | |

† Full range is -40°C to 125°C.

TLC227x, TLC227xA Advanced LinCMOS™ RAIL-TO-RAIL OPERATIONAL AMPLIFIERS

SLOS190G – FEBRUARY 1997 – REVISED MAY 2004

TLC2272Q and TLC2272M electrical characteristics at specified free-air temperature, $V_{DD} = 5\text{ V}$ (unless otherwise noted)

| PARAMETER | TEST CONDITIONS | T_A † | TLC2272Q, TLC2272M | | | TLC2272AQ, TLC2272AM | | | UNIT | |
|----------------------------------------------------------------------------|-------------------------------------------------------------------------------------------------------------------------------------------------------------------------|-----------------------------------------------------------|-----------------------|-------------|-----|-------------------------|-------------|---------------|------------------------------|--|
| | | | MIN | TYP | MAX | MIN | TYP | MAX | | |
| V_{IO} Input offset voltage | | 25°C | 300 | 2500 | | 300 | 950 | μV | | |
| | | Full range | | 3000 | | 1500 | | | | |
| α_{VIO} Temperature coefficient of input offset voltage | | 25°C to 125°C | 2 | | | 2 | | | $\mu\text{V}/^\circ\text{C}$ | |
| Input offset voltage long-term drift (see Note 4) | $V_{IC} = 0\text{ V},$ $V_O = 0\text{ V},$ $V_{DD\pm} = \pm 2.5\text{ V},$ $R_S = 50\ \Omega$ | 25°C | 0.002 | | | 0.002 | | | $\mu\text{V}/\text{mo}$ | |
| I_{IO} Input offset current | | 25°C | 0.5 | 60 | | 0.5 | 60 | pA | | |
| | | Full range | | 800 | | 800 | | | | |
| I_{IB} Input bias current | | 25°C | 1 | 60 | | 1 | 60 | pA | | |
| | | Full range | | 800 | | 800 | | | | |
| V_{ICR} Common-mode input voltage | $R_S = 50\ \Omega,$ $ V_{IO} \leq 5\text{ mV}$ | 25°C | 0 to 4 | -0.3 to 4.2 | | 0 to 4 | -0.3 to 4.2 | V | | |
| | | Full range | 0 to 3.5 | | | 0 to 3.5 | | | | |
| V_{OH} High-level output voltage | $I_{OH} = -20\ \mu\text{A}$ $I_{OH} = -200\ \mu\text{A}$ $I_{OH} = -1\text{ mA}$ | 25°C | 4.99 | | | 4.99 | | | V | |
| | | 25°C | 4.85 | 4.93 | | 4.85 | 4.93 | | | |
| | | Full range | 4.85 | | | 4.85 | | | | |
| | | 25°C | 4.25 | 4.65 | | 4.25 | 4.65 | | | |
| V_{OL} Low-level output voltage | $V_{IC} = 2.5\text{ V},$ $I_{OL} = 50\ \mu\text{A}$ $V_{IC} = 2.5\text{ V},$ $I_{OL} = 500\ \mu\text{A}$ $V_{IC} = 2.5\text{ V},$ $I_{OL} = 5\text{ mA}$ | 25°C | 0.01 | | | 0.01 | | | V | |
| | | 25°C | 0.09 | 0.15 | | 0.09 | 0.15 | | | |
| | | Full range | 0.15 | | | 0.15 | | | | |
| | | 25°C | 0.9 | 1.5 | | 0.9 | 1.5 | | | |
| A_{VD} Large-signal differential voltage amplification | $V_{IC} = 2.5\text{ V},$ $V_O = 1\text{ V to }4\text{ V}$ | $R_L = 10\text{ k}\Omega$ ‡ $R_L = 1\text{ m}\Omega$ ‡ | 25°C | 10 | 35 | | 10 | 35 | V/mV | |
| | | | Full range | 10 | | | 10 | | | |
| | | | 25°C | 175 | | | 175 | | | |
| r_{id} Differential input resistance | | 25°C | 10^{12} | | | 10^{12} | | | Ω | |
| r_i Common-mode input resistance | | 25°C | 10^{12} | | | 10^{12} | | | Ω | |
| C_i Common-mode input capacitance | $f = 10\text{ kHz},$ P package | 25°C | 8 | | | 8 | | | pF | |
| z_o Closed-loop output impedance | $f = 1\text{ MHz},$ $A_V = 10$ | 25°C | 140 | | | 140 | | | Ω | |
| CMRR Common-mode rejection ratio | $V_{IC} = 0\text{ V to }2.7\text{ V},$ $V_O = 2.5\text{ V},$ $R_S = 50\ \Omega$ | 25°C | 70 | 75 | | 70 | 75 | dB | | |
| | | Full range | 70 | | | 70 | | | | |
| k_{SVR} Supply-voltage rejection ratio ($\Delta V_{DD}/\Delta V_{IO}$) | $V_{DD} = 4.4\text{ V to }16\text{ V},$ $V_{IC} = V_{DD}/2,$ No load | 25°C | 80 | 95 | | 80 | 95 | dB | | |
| | | Full range | 80 | | | 80 | | | | |
| I_{DD} Supply current | $V_O = 2.5\text{ V},$ No load | 25°C | 2.2 | 3 | | 2.2 | 3 | mA | | |
| | | Full range | 3 | | | 3 | | | | |

† Full range is -40°C to 125°C for Q level part, -55°C to 125°C for M level part.

‡ Referenced to 2.5 V

NOTE 4: Typical values are based on the input offset voltage shift observed through 168 hours of operating life test at $T_A = 150^\circ\text{C}$ extrapolated to $T_A = 25^\circ\text{C}$ using the Arrhenius equation and assuming an activation energy of 0.96 eV.



TLC227x, TLC227xA
Advanced LinCMOS™ RAIL-TO-RAIL
OPERATIONAL AMPLIFIERS

SLOS190G – FEBRUARY 1997 – REVISED MAY 2004

TLC2272Q and TLC2272M operating characteristics at specified free-air temperature, $V_{DD} = 5\text{ V}$

| PARAMETER | TEST CONDITIONS | T_A † | TLC2272Q, TLC2272M | | | TLC2272AQ, TLC2272AM | | | UNIT |
|-----------|------------------------------------------------------------------------------------------------------------------------------|---------------------------------------------------------------------------------------------------|-----------------------|---------|--------|-------------------------|---------|------------------------|------|
| | | | MIN | TYP | MAX | MIN | TYP | MAX | |
| SR | Slew rate at unity gain $V_O = 1.25\text{ V to }2.75\text{ V}$, $R_L = 10\text{ k}\Omega$ ‡, $C_L = 100\text{ pF}$ ‡ | 25°C | 2.3 | 3.6 | | 2.3 | 3.6 | V/ μs | |
| | | Full range | 1.7 | | | 1.7 | | | |
| V_n | Equivalent input noise voltage | f = 10 Hz | | 50 | | | 50 | nV/ $\sqrt{\text{Hz}}$ | |
| | | f = 1 kHz | | 9 | | | 9 | | |
| V_{NPP} | Peak-to-peak equivalent input noise voltage | f = 0.1 Hz to 1 Hz | | 1 | | | 1 | μV | |
| | | f = 0.1 Hz to 10 Hz | | 1.4 | | | 1.4 | | |
| I_n | Equivalent input noise current | 25°C | | 0.6 | | | 0.6 | fA/ $\sqrt{\text{Hz}}$ | |
| THD + N | Total harmonic distortion plus noise $V_O = 0.5\text{ V to }2.5\text{ V}$, f = 20 kHz, $R_L = 10\text{ k}\Omega$ ‡ | $A_V = 1$ | | 0.0013% | | | 0.0013% | | |
| | | $A_V = 10$ | 25°C | | 0.004% | | 0.004% | | |
| | | $A_V = 100$ | | | 0.03% | | 0.03% | | |
| | Gain-bandwidth product | f = 10 kHz, $R_L = 10\text{ k}\Omega$ ‡, $C_L = 100\text{ pF}$ ‡ | 25°C | | 2.18 | | 2.18 | MHz | |
| B_{OM} | Maximum output-swing bandwidth | $V_{O(PP)} = 2\text{ V}$, $R_L = 10\text{ k}\Omega$ ‡, $A_V = 1$, $C_L = 100\text{ pF}$ ‡ | 25°C | | 1 | | 1 | MHz | |
| t_s | Settling time | $A_V = -1$, Step = 0.5 V to 2.5 V, $R_L = 10\text{ k}\Omega$ ‡, $C_L = 100\text{ pF}$ ‡ | To 0.1% | | 1.5 | | 1.5 | μs | |
| | | To 0.01% | 25°C | | 2.6 | | 2.6 | | |
| ϕ_m | Phase margin at unity gain | $R_L = 10\text{ k}\Omega$ ‡, $C_L = 100\text{ pF}$ ‡ | 25°C | | 50° | | 50° | | |
| | Gain margin | | 25°C | | 10 | | 10 | | dB |

† Full range is -40°C to 125°C for Q level part, -55°C to 125°C for M level part.

‡ Referenced to 2.5 V

TLC227x, TLC227xA Advanced LinCMOS™ RAIL-TO-RAIL OPERATIONAL AMPLIFIERS

SLOS190G – FEBRUARY 1997 – REVISED MAY 2004

TLC2272Q and TLC2272M electrical characteristics at specified free-air temperature, $V_{DD\pm} = \pm 5\text{ V}$ (unless otherwise noted)

| PARAMETER | TEST CONDITIONS | T_A † | TLC2272Q, TLC2272M | | | TLC2272AQ, TLC2272AM | | | UNIT |
|-------------------------------------------------------------------------------|-------------------------------------------------------------------------------------------------------------------------------------------------|-------------------------------------------------------|-----------------------|-------------|------|-------------------------|-------------|---------------|------------------------------|
| | | | MIN | TYP | MAX | MIN | TYP | MAX | |
| V_{IO} Input offset voltage | | 25°C | 300 | 2500 | | 300 | 950 | μV | |
| | | Full range | | | 3000 | | 1500 | | |
| α_{VIO} Temperature coefficient of input offset voltage | | 25°C to 125°C | 2 | | | 2 | | | $\mu\text{V}/^\circ\text{C}$ |
| Input offset voltage long-term drift (see Note 4) | $V_{IC} = 0\text{ V},$ $R_S = 50\ \Omega$ $V_O = 0\text{ V},$ | 25°C | 0.002 | | | 0.002 | | | $\mu\text{V}/\text{mo}$ |
| I_{IO} Input offset current | | 25°C | 0.5 | 60 | | 0.5 | 60 | pA | |
| | | Full range | | | 800 | | 800 | | |
| I_{IB} Input bias current | | 25°C | 1 | | 60 | 1 | | 60 | pA |
| | | Full range | | | 800 | | | 800 | |
| V_{ICR} Common-mode input voltage | $R_S = 50\ \Omega,$ $ V_{IO} \leq 5\text{ mV}$ | 25°C | -5 to 4 | -5.3 to 4.2 | | -5 to 4 | -5.3 to 4.2 | V | |
| | | Full range | -5 to 3.5 | | | -5 to 3.5 | | | |
| V_{OM+} Maximum positive peak output voltage | $I_O = -20\ \mu\text{A}$ $I_O = -200\ \mu\text{A}$ $I_O = -1\text{ mA}$ | 25°C | 4.99 | | | 4.99 | | V | |
| | | 25°C | 4.85 | 4.93 | | 4.85 | 4.93 | | |
| | | Full range | 4.85 | | | 4.85 | | | |
| | | 25°C | 4.25 | 4.65 | | 4.25 | 4.65 | | |
| V_{OM-} Maximum negative peak output voltage | $V_{IC} = 0\text{ V},$ $I_O = 50\ \mu\text{A}$ $V_{IC} = 0\text{ V},$ $I_O = 500\ \mu\text{A}$ $V_{IC} = 0\text{ V},$ $I_O = 5\text{ mA}$ | 25°C | -4.99 | | | -4.99 | | V | |
| | | 25°C | -4.85 | -4.91 | | -4.85 | -4.91 | | |
| | | Full range | -4.85 | | | -4.85 | | | |
| | | 25°C | -3.5 | -4.1 | | -3.5 | -4.1 | | |
| V_{OM-} Maximum negative peak output voltage | $V_{IC} = 0\text{ V},$ $I_O = 5\text{ mA}$ | 25°C | -3.5 | | | -3.5 | | V | |
| | | Full range | -3.5 | | | -3.5 | | | |
| | | 25°C | -3.5 | | | -3.5 | | | |
| A_{VD} Large-signal differential voltage amplification | $V_O = \pm 4\text{ V}$ | $R_L = 10\text{ k}\Omega$ $R_L = 1\text{ m}\Omega$ | 25°C | 20 | 50 | | 20 | 50 | V/mV |
| | | | Full range | 20 | | | 20 | | |
| | | | 25°C | 300 | | | 300 | | |
| r_{id} Differential input resistance | | 25°C | 10^{12} | | | 10^{12} | | | Ω |
| r_i Common-mode input resistance | | 25°C | 10^{12} | | | 10^{12} | | | Ω |
| c_i Common-mode input capacitance | $f = 10\text{ kHz},$ P package | 25°C | 8 | | | 8 | | | pF |
| z_o Closed-loop output impedance | $f = 1\text{ MHz},$ $A_V = 10$ | 25°C | 130 | | | 130 | | | Ω |
| CMRR Common-mode rejection ratio | $V_{IC} = -5\text{ V to } 2.7\text{ V},$ $V_O = 0\text{ V},$ $R_S = 50\ \Omega$ | 25°C | 75 | 80 | | 75 | 80 | dB | |
| | | Full range | 75 | | | 75 | | | |
| k_{SVR} Supply-voltage rejection ratio ($\Delta V_{DD\pm}/\Delta V_{IO}$) | $V_{DD} = \pm 2.2\text{ V to } \pm 8\text{ V},$ $V_{IC} = 0\text{ V},$ No load | 25°C | 80 | 95 | | 80 | 95 | dB | |
| | | Full range | 80 | | | 80 | | | |
| I_{DD} Supply current | $V_O = 2.5\text{ V},$ No load | 25°C | 2.4 | 3 | | 2.4 | 3 | mA | |
| | | Full range | 3 | | | 3 | | | |

† Full range is -40°C to 125°C for Q level part, -55°C to 125°C for M level part.

NOTE 4: Typical values are based on the input offset voltage shift observed through 168 hours of operating life test at $T_A = 150^\circ\text{C}$ extrapolated to $T_A = 25^\circ\text{C}$ using the Arrhenius equation and assuming an activation energy of 0.96 eV.



TLC227x, TLC227xA
Advanced LinCMOS™ RAIL-TO-RAIL
OPERATIONAL AMPLIFIERS

SLOS190G – FEBRUARY 1997 – REVISED MAY 2004

**TLC2272Q and TLC2272M operating characteristics at specified free-air temperature,
 $V_{DD\pm} = \pm 5\text{ V}$**

| PARAMETER | TEST CONDITIONS | T_A † | TLC2272Q, TLC2272M | | | TLC2272AQ, TLC2272AM | | | UNIT |
|-----------|---------------------------------------------------------------------------------------------------------------------------------------|------------|-----------------------|-------------|---------|-------------------------|---------|-----|------------------------|
| | | | MIN | TYP | MAX | MIN | TYP | MAX | |
| SR | Slew rate at unity gain $V_O = \pm 1\text{ V}$, $C_L = 100\text{ pF}$, $R_L = 10\text{ k}\Omega$ | 25°C | 2.3 | 3.6 | | 2.3 | 3.6 | | V/ μs |
| | | Full range | 1.7 | | | 1.7 | | | |
| V_n | Equivalent input noise voltage $f = 10\text{ Hz}$ $f = 1\text{ kHz}$ | 25°C | | 50 | | | 50 | | nV/ $\sqrt{\text{Hz}}$ |
| | | 25°C | | 9 | | | 9 | | |
| V_{NPP} | Peak-to-peak equivalent input noise voltage $f = 0.1\text{ Hz to }1\text{ Hz}$ $f = 0.1\text{ Hz to }10\text{ Hz}$ | 25°C | | 1 | | | 1 | | μV |
| | | 25°C | | 1.4 | | | 1.4 | | |
| I_n | Equivalent input noise current | 25°C | | 0.6 | | | 0.6 | | fA/ $\sqrt{\text{Hz}}$ |
| THD + N | Total harmonic distortion plus noise $V_O = \pm 2.3\text{ V}$ $R_L = 10\text{ k}\Omega$, $f = 20\text{ kHz}$ | 25°C | | $A_V = 1$ | 0.0011% | | 0.0011% | | |
| | | | | $A_V = 10$ | 0.004% | | 0.004% | | |
| | | | | $A_V = 100$ | 0.03% | | 0.03% | | |
| | Gain-bandwidth product $f = 10\text{ kHz}$, $C_L = 100\text{ pF}$, $R_L = 10\text{ k}\Omega$ | 25°C | | 2.25 | | | 2.25 | | MHz |
| BOM | Maximum output-swing bandwidth $V_{O(PP)} = 4.6\text{ V}$, $R_L = 10\text{ k}\Omega$, $A_V = 1$, $C_L = 100\text{ pF}$ | 25°C | | 0.54 | | | 0.54 | | MHz |
| t_s | Settling time $A_V = -1$, Step = $-2.3\text{ V to }2.3\text{ V}$, $R_L = 10\text{ k}\Omega$, $C_L = 100\text{ pF}$ | 25°C | | To 0.1% | 1.5 | | 1.5 | | μs |
| | | | | To 0.01% | 3.2 | | 3.2 | | |
| ϕ_m | Phase margin at unity gain $R_L = 10\text{ k}\Omega$, $C_L = 100\text{ pF}$ | 25°C | | 52° | | | 52° | | |
| | | 25°C | | 10 | | | 10 | | dB |

† Full range is -40°C to 125°C for Q level part, -55°C to 125°C for M level part.

TLC227x, TLC227xA Advanced LinCMOS™ RAIL-TO-RAIL OPERATIONAL AMPLIFIERS

SLOS190G – FEBRUARY 1997 – REVISED MAY 2004

TLC2274Q and TLC2274M electrical characteristics at specified free-air temperature, $V_{DD} = 5\text{ V}$ (unless otherwise noted)

| PARAMETER | TEST CONDITIONS | T_A † | TLC2274Q, TLC2274M | | | TLC2274AQ, TLC2274AM | | | UNIT |
|----------------------------------------------------------------------------|----------------------------------------------------------------------------------------------------------------------------------------------------------------------------|------------------------------------|-----------------------|-------------|-----|-------------------------|-------------|---------------|------------------------------|
| | | | MIN | TYP | MAX | MIN | TYP | MAX | |
| V_{IO} Input offset voltage | | 25°C | 300 | 2500 | | 300 | 950 | μV | |
| | | Full range | | 3000 | | 1500 | | | |
| α_{VIO} Temperature coefficient of input offset voltage | | 25°C to 125°C | 2 | | | 2 | | | $\mu\text{V}/^\circ\text{C}$ |
| Input offset voltage long-term drift (see Note 4) | $V_{DD\pm} = \pm 2.5\text{ V}$, $V_O = 0\text{ V}$, $V_{IC} = 0\text{ V}$, $R_S = 50\ \Omega$ | 25°C | 0.002 | | | 0.002 | | | $\mu\text{V}/\text{mo}$ |
| I_{IO} Input offset current | | 25°C | 0.5 | 60 | | 0.5 | 60 | pA | |
| | | Full range | | 800 | | 800 | | | |
| I_{IB} Input bias current | | 25°C | 1 | | 60 | 1 | | 60 | pA |
| | | Full range | | | 800 | | | 800 | |
| V_{ICR} Common-mode input voltage | $R_S = 50\ \Omega$, $ V_{IO} \leq 5\text{ mV}$ | 25°C | 0 to 4 | -0.3 to 4.2 | | 0 to 4 | -0.3 to 4.2 | V | |
| | | Full range | 0 to 3.5 | | | 0 to 3.5 | | | |
| V_{OH} High-level output voltage | $I_{OH} = -20\ \mu\text{A}$ $I_{OH} = -200\ \mu\text{A}$ $I_{OH} = -1\text{ mA}$ | 25°C | 4.99 | | | 4.99 | | V | |
| | | 25°C | 4.85 | 4.93 | | 4.85 | 4.93 | | |
| | | Full range | 4.85 | | | 4.85 | | | |
| | | 25°C | 4.25 | 4.65 | | 4.25 | 4.65 | | |
| V_{OL} Low-level output voltage | $V_{IC} = 2.5\text{ V}$, $I_{OL} = 50\ \mu\text{A}$ $V_{IC} = 2.5\text{ V}$, $I_{OL} = 500\ \mu\text{A}$ $V_{IC} = 2.5\text{ V}$, $I_{OL} = 5\text{ mA}$ | 25°C | 0.01 | | | 0.01 | | V | |
| | | 25°C | 0.09 | 0.15 | | 0.09 | 0.15 | | |
| | | Full range | 0.15 | | | 0.15 | | | |
| | | 25°C | 0.9 | 1.5 | | 0.9 | 1.5 | | |
| AVD Large-signal differential voltage amplification | $V_{IC} = 2.5\text{ V}$, $V_O = 1\text{ V to }4\text{ V}$ | $R_L = 10\text{ k}\Omega^\ddagger$ | 25°C | 10 | 35 | | 10 | 35 | V/mV |
| | | | Full range | 10 | | | 10 | | |
| | | $R_L = 1\text{ M}\Omega^\ddagger$ | 25°C | 175 | | | 175 | | |
| r_{id} Differential input resistance | | 25°C | 10^{12} | | | 10^{12} | | | Ω |
| r_i Common-mode input resistance | | 25°C | 10^{12} | | | 10^{12} | | | Ω |
| c_i Common-mode input capacitance | $f = 10\text{ kHz}$, N package | 25°C | 8 | | | 8 | | | pF |
| z_o Closed-loop output impedance | $f = 1\text{ MHz}$, $A_V = 10$ | 25°C | 140 | | | 140 | | | Ω |
| CMRR Common-mode rejection ratio | $V_{IC} = 0\text{ V to }2.7\text{ V}$, $V_O = 2.5\text{ V}$, $R_S = 50\ \Omega$ | 25°C | 70 | 75 | | 70 | 75 | dB | |
| | | Full range | 70 | | | 70 | | | |
| k_{SVR} Supply-voltage rejection ratio ($\Delta V_{DD}/\Delta V_{IO}$) | $V_{DD} = 4.4\text{ V to }16\text{ V}$, $V_{IC} = V_{DD}/2$, No load | 25°C | 80 | 95 | | 80 | 95 | dB | |
| | | Full range | 80 | | | 80 | | | |
| I_{DD} Supply current | $V_O = 2.5\text{ V}$, No load | 25°C | 4.4 | 6 | | 4.4 | 6 | mA | |
| | | Full range | 6 | | | 6 | | | |

† Full range is -40°C to 125°C for Q level part, -55°C to 125°C for M level part.

‡ Referenced to 2.5 V

NOTE 4: Typical values are based on the input offset voltage shift observed through 168 hours of operating life test at $T_A = 150^\circ\text{C}$ extrapolated to $T_A = 25^\circ\text{C}$ using the Arrhenius equation and assuming an activation energy of 0.96 eV.



TLC227x, TLC227xA
Advanced LinCMOS™ RAIL-TO-RAIL
OPERATIONAL AMPLIFIERS

SLOS190G – FEBRUARY 1997 – REVISED MAY 2004

TLC2274Q and TLC2274M operating characteristics at specified free-air temperature, $V_{DD} = 5\text{ V}$

| PARAMETER | TEST CONDITIONS | T_A † | TLC2274Q, TLC2274M | | | TLC2274AQ, TLC2274AM | | | UNIT | |
|-------------|---------------------------------------------------------------------------------------------------------------------------|------------|-----------------------|---------|-----|-------------------------|---------|-----|------------------------|---------|
| | | | MIN | TYP | MAX | MIN | TYP | MAX | | |
| SR | Slew rate at unity gain $V_O = 0.5\text{ V to }2.5\text{ V}, C_L = 100\text{ pF}‡$ $R_L = 10\text{ k}\Omega‡$ | 25°C | 2.3 | 3.6 | | 2.3 | 3.6 | | V/ μ s | |
| | | Full range | 1.7 | | | 1.7 | | | | |
| V_n | Equivalent input noise voltage $f = 10\text{ Hz}$ $f = 1\text{ kHz}$ | 25°C | 50 | | | 50 | | | nV/ $\sqrt{\text{Hz}}$ | |
| | | 25°C | 9 | | | 9 | | | | |
| $V_{N(PP)}$ | Peak-to-peak equivalent input noise voltage $f = 0.1\text{ Hz to }1\text{ Hz}$ $f = 0.1\text{ Hz to }10\text{ Hz}$ | 25°C | 1 | | | 1 | | | μ V | |
| | | 25°C | 1.4 | | | 1.4 | | | | |
| I_n | Equivalent input noise current | 25°C | 0.6 | | | 0.6 | | | fA/ $\sqrt{\text{Hz}}$ | |
| THD + N | Total harmonic distortion plus noise $V_O = 0.5\text{ V to }2.5\text{ V}, f = 20\text{ kHz}, R_L = 10\text{ k}\Omega‡$ | 25°C | $A_V = 1$ | 0.0013% | | | 0.0013% | | | |
| | | | $A_V = 10$ | 0.004% | | | 0.004% | | | |
| | | | $A_V = 100$ | 0.03% | | | 0.03% | | | |
| | Gain-bandwidth product $f = 10\text{ kHz}, C_L = 100\text{ pF}‡$ | 25°C | 2.18 | | | 2.18 | | | MHz | |
| B_{OM} | Maximum output-swing bandwidth $V_{O(PP)} = 2\text{ V}, R_L = 10\text{ k}\Omega‡$ | 25°C | 1 | | | 1 | | | MHz | |
| t_s | Settling time $A_V = -1, \text{ Step} = 0.5\text{ V to }2.5\text{ V}, R_L = 10\text{ k}\Omega‡, C_L = 100\text{ pF}‡$ | 25°C | To 0.1% | 1.5 | | | 1.5 | | | μ s |
| | | | To 0.01% | 2.6 | | | 2.6 | | | |
| ϕ_m | Phase margin at unity gain $R_L = 10\text{ k}\Omega‡, C_L = 100\text{ pF}‡$ | 25°C | 50° | | | 50° | | | | |
| | | 25°C | 10 | | | 10 | | | dB | |

† Full range is -40°C to 125°C for Q level part, -55°C to 125°C for M level part.

‡ Referenced to 2.5 V

TLC227x, TLC227xA Advanced LinCMOS™ RAIL-TO-RAIL OPERATIONAL AMPLIFIERS

SLOS190G – FEBRUARY 1997 – REVISED MAY 2004

TLC2274Q and TLC2274M electrical characteristics at specified free-air temperature, $V_{DD\pm} = \pm 5\text{ V}$ (unless otherwise noted)

| PARAMETER | TEST CONDITIONS | T_A † | TLC2274Q, TLC2274M | | | TLC2274AQ, TLC2274AM | | | UNIT |
|-------------------------------------------------------------------------------|-----------------------------------------------------------------------------------------|---------------------------|-----------------------|-------------|-----------|-------------------------|-------------|---------------|------------------------------|
| | | | MIN | TYP | MAX | MIN | TYP | MAX | |
| V_{IO} Input offset voltage | $V_{IC} = 0\text{ V}, V_O = 0\text{ V}, R_S = 50\ \Omega$ | 25°C | 300 | 2500 | | 300 | 950 | μV | |
| | | Full range | | | 3000 | | 1500 | | |
| α_{VIO} Temperature coefficient of input offset voltage | | 25°C to 125°C | 2 | | | 2 | | | $\mu\text{V}/^\circ\text{C}$ |
| Input offset voltage long-term drift (see Note 4) | | 25°C | 0.002 | | | 0.002 | | | $\mu\text{V}/\text{mo}$ |
| I_{IO} Input offset current | | 25°C | 0.5 | 60 | | 0.5 | 60 | pA | |
| | | Full range | | | 800 | | 800 | | |
| I_{IB} Input bias current | 25°C | 1 | 60 | | 1 | 60 | pA | | |
| | Full range | | | 800 | | 800 | | | |
| V_{ICR} Common-mode input voltage | $R_S = 50\ \Omega, V_{IO} \leq 5\text{ mV}$ | 25°C | -5 to 4 | -5.3 to 4.2 | | -5 to 4 | -5.3 to 4.2 | V | |
| | | Full range | | | -5 to 3.5 | | -5 to 3.5 | | |
| V_{OM+} Maximum positive peak output voltage | $I_O = -20\ \mu\text{A}$ | 25°C | 4.85 | 4.93 | | 4.85 | 4.93 | V | |
| | | Full range | 4.85 | | | 4.85 | | | |
| | | 25°C | 4.25 | 4.65 | | 4.25 | 4.65 | | |
| | | Full range | 4.25 | | | 4.25 | | | |
| V_{OM-} Maximum negative peak output voltage | $I_O = -1\text{ mA}$ | 25°C | -4.85 | -4.91 | | -4.85 | -4.91 | V | |
| | | Full range | -4.85 | | | -4.85 | | | |
| | | 25°C | -3.5 | -4.1 | | -3.5 | -4.1 | | |
| | | Full range | -3.5 | | | -3.5 | | | |
| $V_{IC} = 0\text{ V}, I_O = 50\ \mu\text{A}$ | $V_{IC} = 0\text{ V}, I_O = 500\ \mu\text{A}$ | 25°C | -4.99 | | | -4.99 | V | | |
| | | 25°C | -4.85 | -4.91 | | -4.85 | | -4.91 | |
| | | Full range | -4.85 | | | -4.85 | | | |
| $V_{IC} = 0\text{ V}, I_O = 5\text{ mA}$ | 25°C | -3.5 | -4.1 | | -3.5 | -4.1 | | | |
| | Full range | -3.5 | | | -3.5 | | | | |
| AVD Large-signal differential voltage amplification | $V_O = \pm 4\text{ V}$ | $R_L = 10\text{ k}\Omega$ | 25°C | 20 | 50 | | | 20 | 50 |
| | | | Full range | 20 | | | 20 | | |
| | | $R_L = 1\text{ M}\Omega$ | 25°C | 300 | | | 300 | | |
| r_{id} Differential input resistance | | 25°C | 10^{12} | | | 10^{12} | | | Ω |
| r_i Common-mode input resistance | | 25°C | 10^{12} | | | 10^{12} | | | Ω |
| c_i Common-mode input capacitance | $f = 10\text{ kHz}, \text{ N package}$ | 25°C | 8 | | | 8 | | | pF |
| z_o Closed-loop output impedance | $f = 1\text{ MHz}, A_V = 10$ | 25°C | 130 | | | 130 | | | Ω |
| CMRR Common-mode rejection ratio | $V_{IC} = -5\text{ V to } 2.7\text{ V}, V_O = 0\text{ V}, R_S = 50\ \Omega$ | 25°C | 75 | 80 | | 75 | 80 | dB | |
| | | Full range | 75 | | | 75 | | | |
| k_{SVR} Supply-voltage rejection ratio ($\Delta V_{DD\pm}/\Delta V_{IO}$) | $V_{DD\pm} = \pm 2.2\text{ V to } \pm 8\text{ V}, V_{IC} = 0\text{ V}, \text{ No load}$ | 25°C | 80 | 95 | | 80 | 95 | dB | |
| | | Full range | 80 | | | 80 | | | |
| I_{DD} Supply current | $V_O = 0\text{ V}, \text{ No load}$ | 25°C | 4.8 | 6 | | 4.8 | 6 | mA | |
| | | Full range | | | 6 | | 6 | | |

† Full range is -40°C to 125°C for Q level part, -55°C to 125°C for M level part.

NOTE 4: Typical values are based on the input offset voltage shift observed through 168 hours of operating life test at $T_A = 150^\circ\text{C}$ extrapolated to $T_A = 25^\circ\text{C}$ using the Arrhenius equation and assuming an activation energy of 0.96 eV.



TLC227x, TLC227xA
Advanced LinCMOS™ RAIL-TO-RAIL
OPERATIONAL AMPLIFIERS

SLOS190G – FEBRUARY 1997 – REVISED MAY 2004

**TLC2274Q and TLC2274M operating characteristics at specified free-air temperature,
 $V_{DD\pm} = \pm 5\text{ V}$**

| PARAMETER | TEST CONDITIONS | T_A † | TLC2274Q, TLC2274M | | | TLC2274AQ, TLC2274AM | | | UNIT |
|-------------|------------------------------------------------------------------------------------------------------------------------------------|------------|-----------------------|-------------|-----|-------------------------|------|---------|------------------------|
| | | | MIN | TYP | MAX | MIN | TYP | MAX | |
| SR | Slew rate at unity gain $V_O = \pm 2.3\text{ V},$ $R_L = 10\text{ k}\Omega,$ $C_L = 100\text{ pF}$ | 25°C | 2.3 | 3.6 | | 2.3 | 3.6 | | V/ μs |
| | | Full range | 1.7 | | | 1.7 | | | |
| V_n | Equivalent input noise voltage $f = 10\text{ Hz}$ $f = 1\text{ kHz}$ | 25°C | | 50 | | | 50 | | nV/ $\sqrt{\text{Hz}}$ |
| | | 25°C | | 9 | | | 9 | | |
| $V_{N(PP)}$ | Peak-to-peak equivalent input noise voltage $f = 0.1\text{ Hz to }1\text{ Hz}$ $f = 0.1\text{ Hz to }10\text{ Hz}$ | 25°C | | 1 | | | 1 | | μV |
| | | 25°C | | 1.4 | | | 1.4 | | |
| I_n | Equivalent input noise current | 25°C | | 0.6 | | | 0.6 | | fA/ $\sqrt{\text{Hz}}$ |
| THD + N | Total harmonic distortion plus noise $V_O = \pm 2.3\text{ V},$ $R_L = 10\text{ k}\Omega,$ $f = 20\text{ kHz}$ | 25°C | | $A_V = 1$ | | 0.0011% | | 0.0011% | |
| | | | | $A_V = 10$ | | 0.004% | | 0.004% | |
| | | | | $A_V = 100$ | | 0.03% | | 0.03% | |
| | Gain-bandwidth product $f = 10\text{ kHz},$ $R_L = 10\text{ k}\Omega,$ $C_L = 100\text{ pF}$ | 25°C | | 2.25 | | | 2.25 | | MHz |
| BOM | Maximum output-swing bandwidth $V_{O(PP)} = 4.6\text{ V},$ $R_L = 10\text{ k}\Omega,$ $A_V = 1,$ $C_L = 100\text{ pF}$ | 25°C | | 0.54 | | | 0.54 | | MHz |
| t_s | Settling time $A_V = -1,$ Step = $-2.3\text{ V to }2.3\text{ V},$ $R_L = 10\text{ k}\Omega,$ $C_L = 100\text{ pF}$ | 25°C | | To 0.1% | | 1.5 | | 1.5 | μs |
| | | | | To 0.01% | | 3.2 | | 3.2 | |
| ϕ_m | Phase margin at unit gain $R_L = 10\text{ k}\Omega,$ $C_L = 100\text{ pF}$ | 25°C | | 52° | | | 52° | | |
| | | 25°C | | 10 | | | 10 | | dB |

† Full range is -40°C to 125°C for Q level part, -55°C to 125°C for M level part.

TLC227x, TLC227xA
Advanced LinCMOS™ RAIL-TO-RAIL
OPERATIONAL AMPLIFIERS

SLOS190G – FEBRUARY 1997 – REVISED MAY 2004

TYPICAL CHARACTERISTICS

Table of Graphs

| | | | FIGURE |
|-----------------|------------------------------------------------------------------|----------------------------------------------|----------------------------------------------|
| V_{IO} | Input offset voltage | Distribution vs Common-mode voltage | 1 – 4 5, 6 |
| αV_{IO} | Input offset voltage temperature coefficient | Distribution | 7 – 10 |
| I_{IB}/I_{IO} | Input bias and input offset current | vs Free-air temperature | 11 |
| V_I | Input voltage | vs Supply voltage vs Free-air temperature | 12 13 |
| V_{OH} | High-level output voltage | vs High-level output current | 14 |
| V_{OL} | Low-level output voltage | vs Low-level output current | 15, 16 |
| V_{OM+} | Maximum positive peak output voltage | vs Output current | 17 |
| V_{OM-} | Maximum negative peak output voltage | vs Output current | 18 |
| $V_{O(PP)}$ | Maximum peak-to-peak output voltage | vs Frequency | 19 |
| I_{OS} | Short-circuit output current | vs Supply voltage vs Free-air temperature | 20 21 |
| V_O | Output voltage | vs Differential input voltage | 22, 23 |
| A_{VD} | Large-signal differential voltage amplification | vs Load resistance | 24 |
| | Large-signal differential voltage amplification and phase margin | vs Frequency | 25, 26 |
| | Large-signal differential voltage amplification | vs Free-air temperature | 27, 28 |
| z_o | Output impedance | vs Frequency | 29, 30 |
| CMRR | Common-mode rejection ratio | vs Frequency | 31 |
| | | vs Free-air temperature | 32 |
| kSVR | Supply-voltage rejection ratio | vs Frequency | 33, 34 |
| | | vs Free-air temperature | 35 |
| I_{DD} | Supply current | vs Supply voltage | 36, 37 |
| | | vs Free-air temperature | 38, 39 |
| SR | Slew rate | vs Load capacitance | 40 |
| | | vs Free-air temperature | 41 |
| V_O | Inverting large-signal pulse response | | 42, 43 |
| | Voltage-follower large-signal pulse response | | 44, 45 |
| | Inverting small-signal pulse response | | 46, 47 |
| | Voltage-follower small-signal pulse response | | 48, 49 |
| V_n | Equivalent input noise voltage | vs Frequency | 50, 51 |
| | Noise voltage over a 10-second period | | 52 |
| | Integrated noise voltage | vs Frequency | 53 |
| THD + N | Total harmonic distortion plus noise | vs Frequency | 54 |
| | | Gain-bandwidth product | vs Supply voltage vs Free-air temperature |
| ϕ_m | Phase margin | vs Load capacitance | 57 |
| | Gain margin | vs Load capacitance | 58 |

NOTE: For all graphs where $V_{DD} = 5\text{ V}$, all loads are referenced to 2.5 V.



TYPICAL CHARACTERISTICS

DISTRIBUTION OF TLC2272
 INPUT OFFSET VOLTAGE

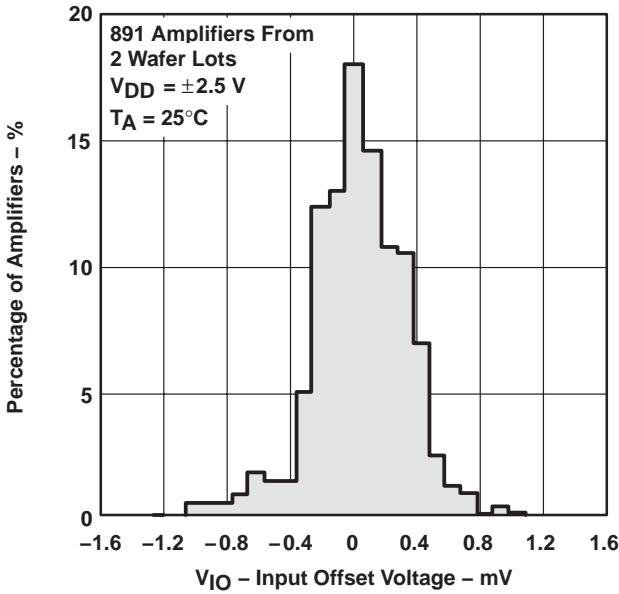

Figure 1

DISTRIBUTION OF TLC2272
 INPUT OFFSET VOLTAGE

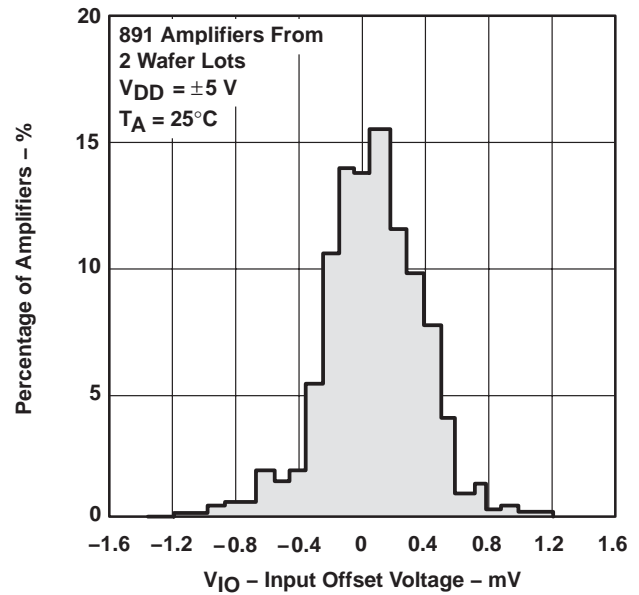

Figure 2

DISTRIBUTION OF TLC2274
 INPUT OFFSET VOLTAGE



Figure 3

DISTRIBUTION OF TLC2274
 INPUT OFFSET VOLTAGE

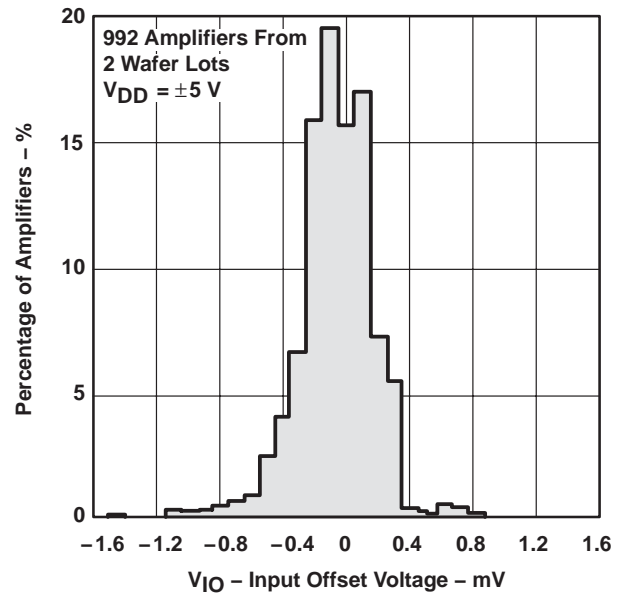
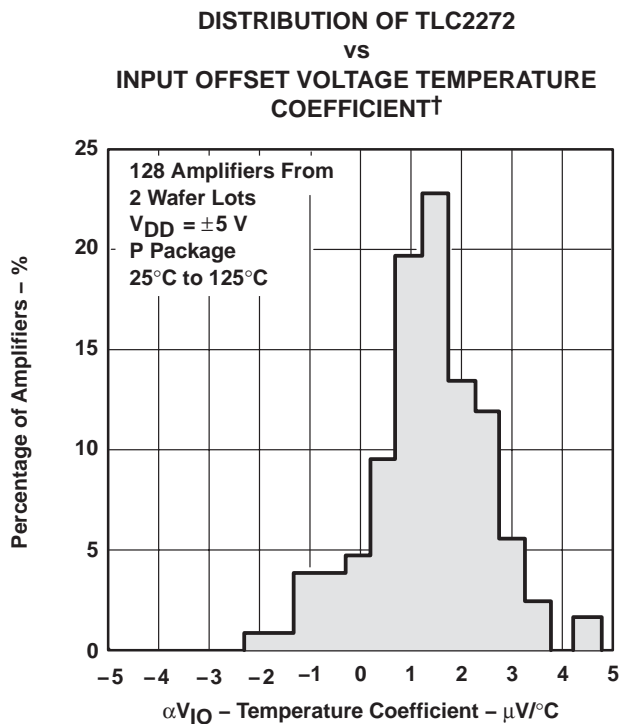
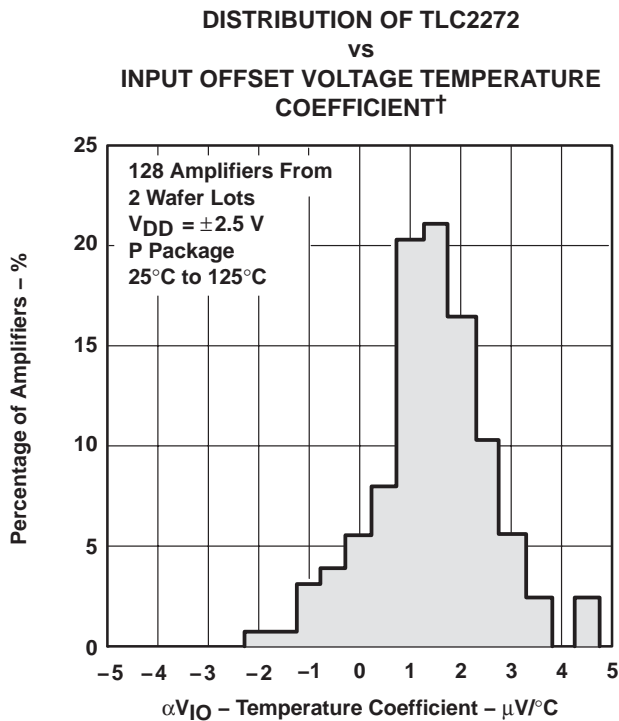
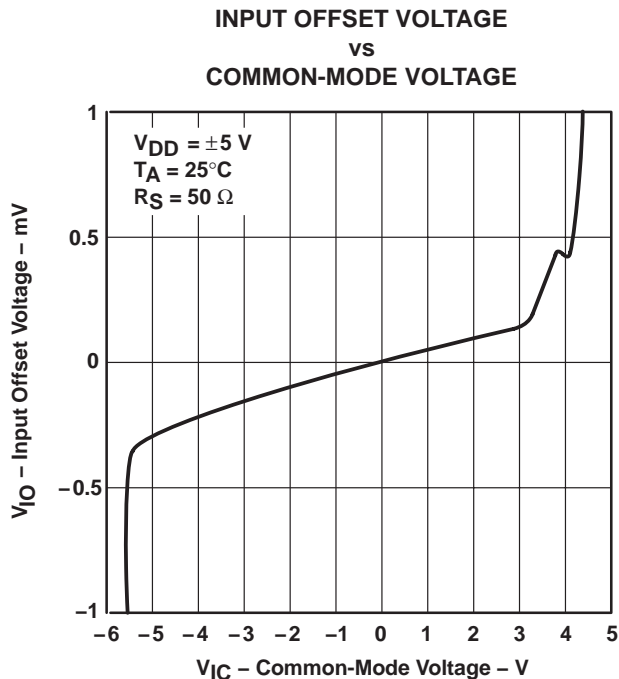
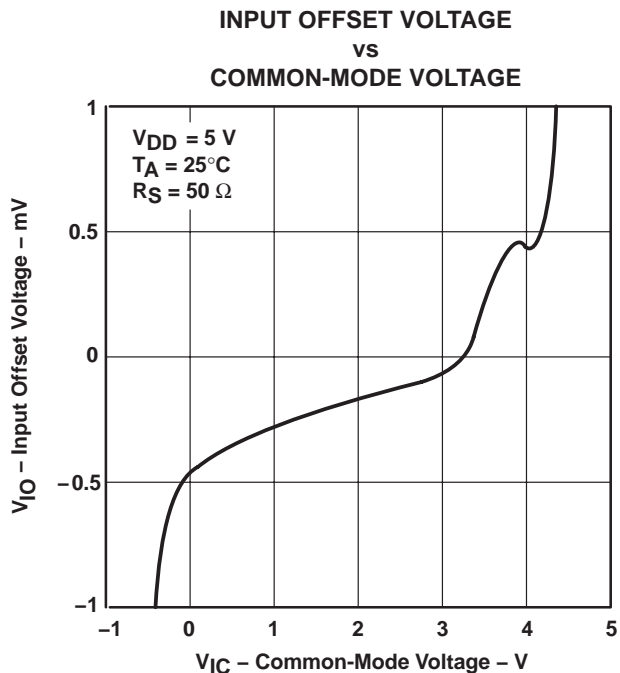

Figure 4

TYPICAL CHARACTERISTICS



† Data at high and low temperatures are applicable only within the rated operating free-air temperature ranges of the various devices.

TYPICAL CHARACTERISTICS

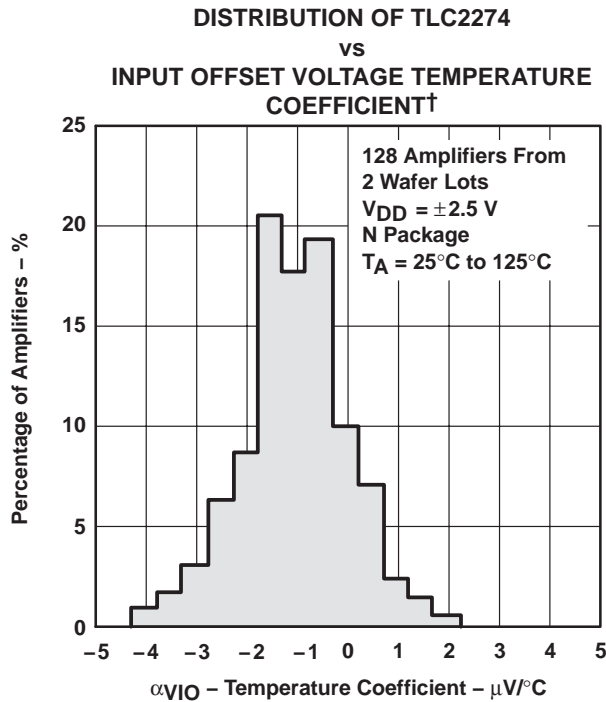

Figure 9

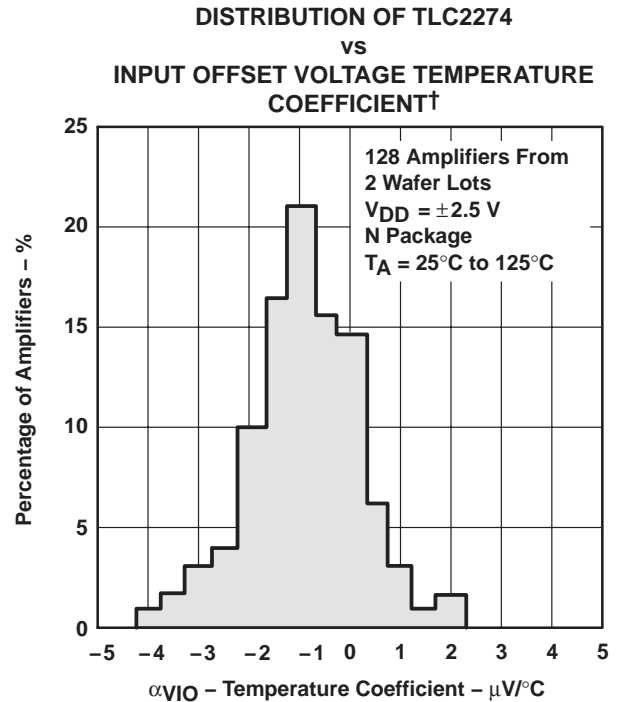

Figure 10

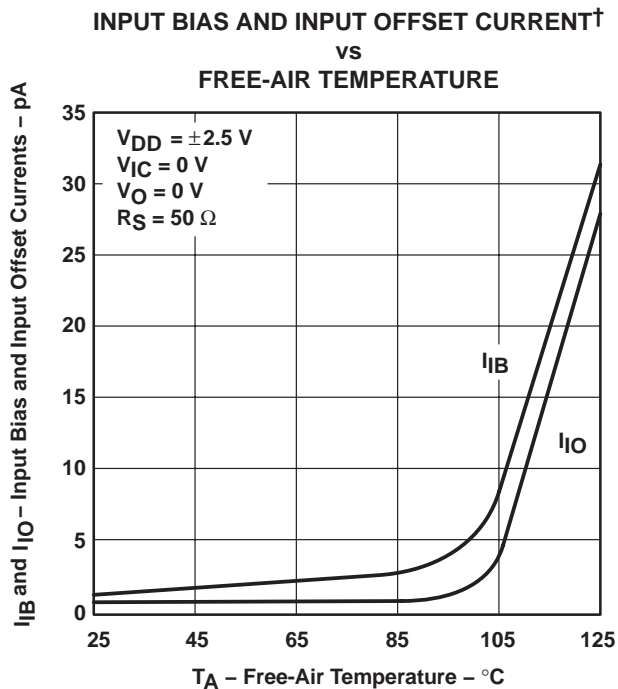

Figure 11

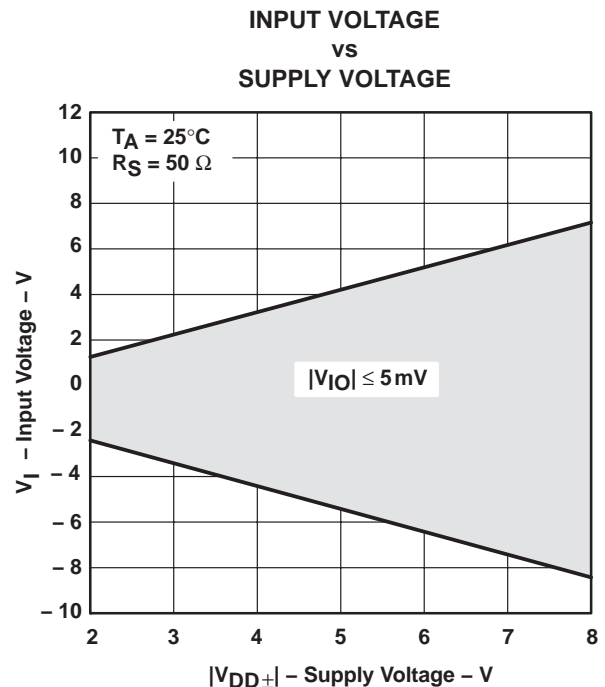

Figure 12

† Data at high and low temperatures are applicable only within the rated operating free-air temperature ranges of the various devices.

TYPICAL CHARACTERISTICS



Figure 13

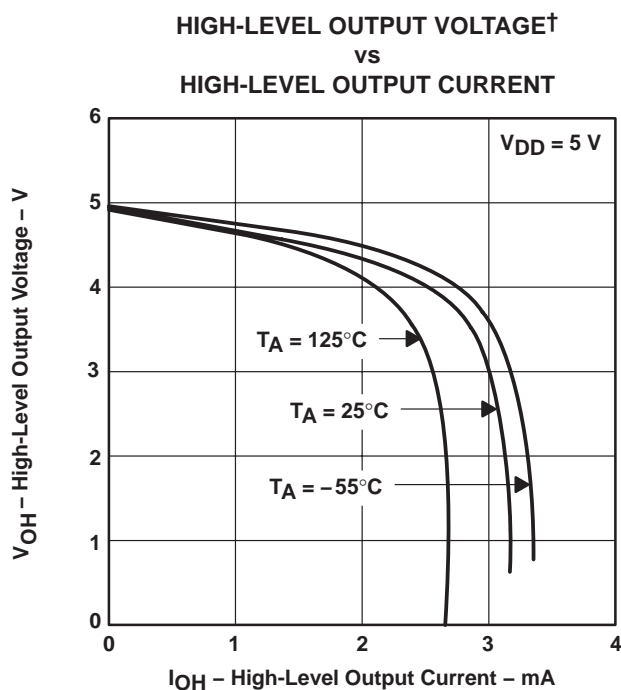

Figure 14

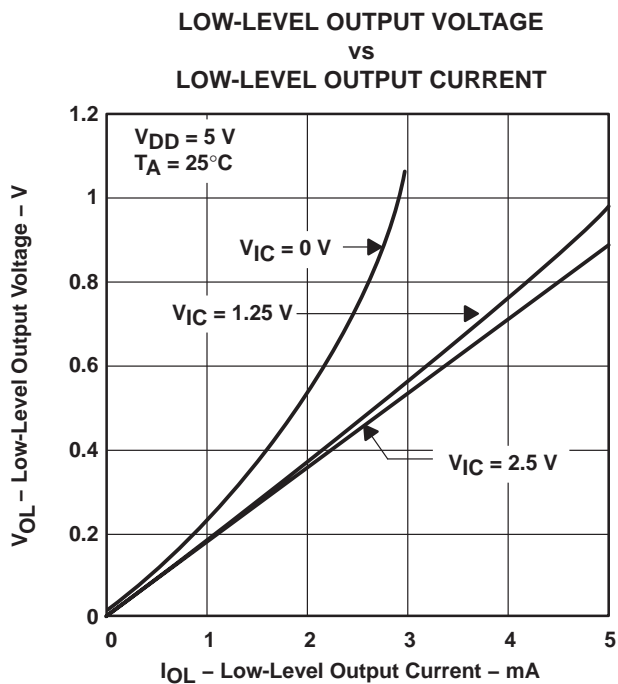

Figure 15

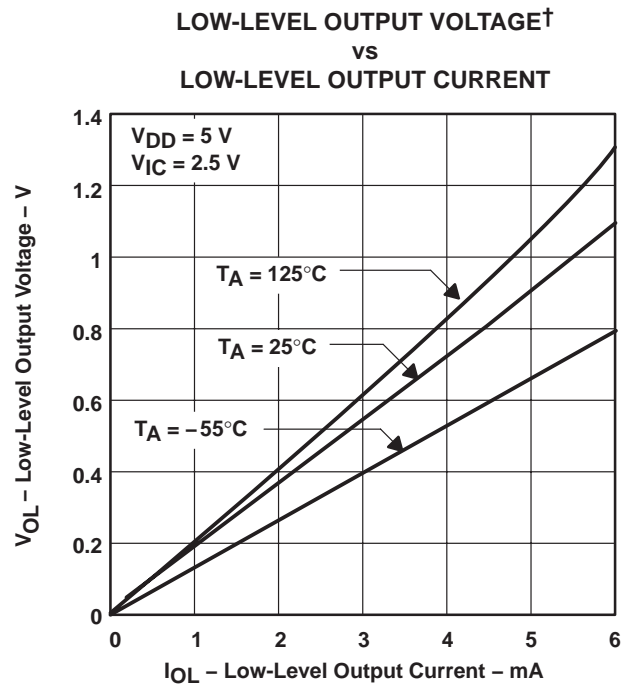

Figure 16

† Data at high and low temperatures are applicable only within the rated operating free-air temperature ranges of the various devices.

TYPICAL CHARACTERISTICS

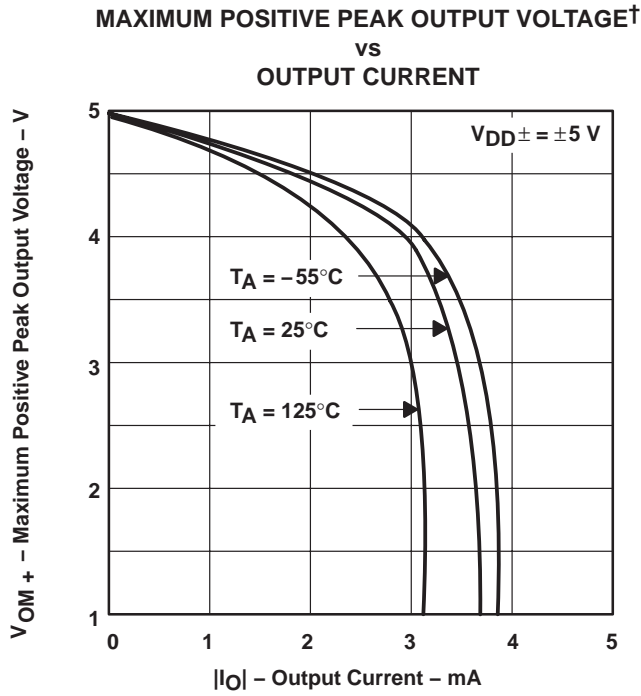

Figure 17

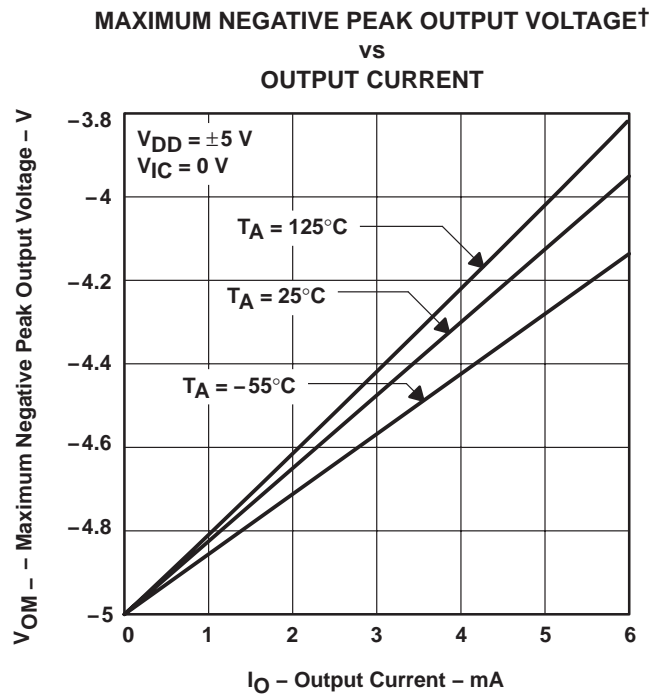

Figure 18

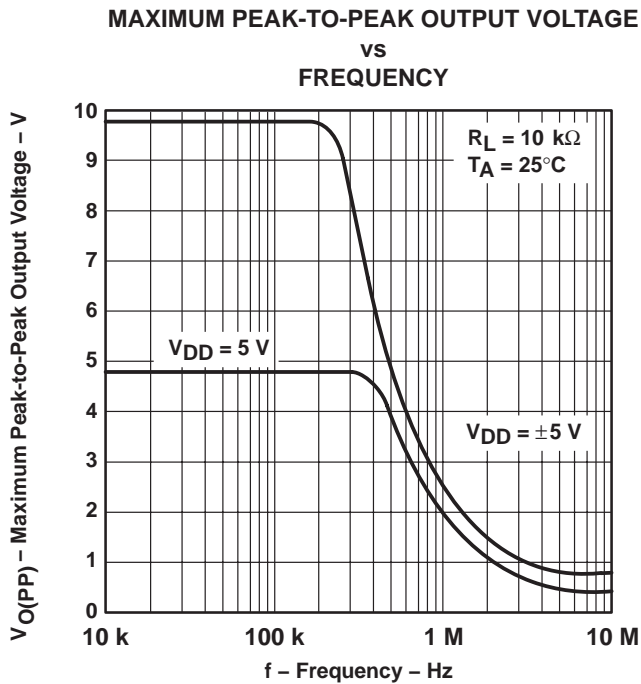

Figure 19

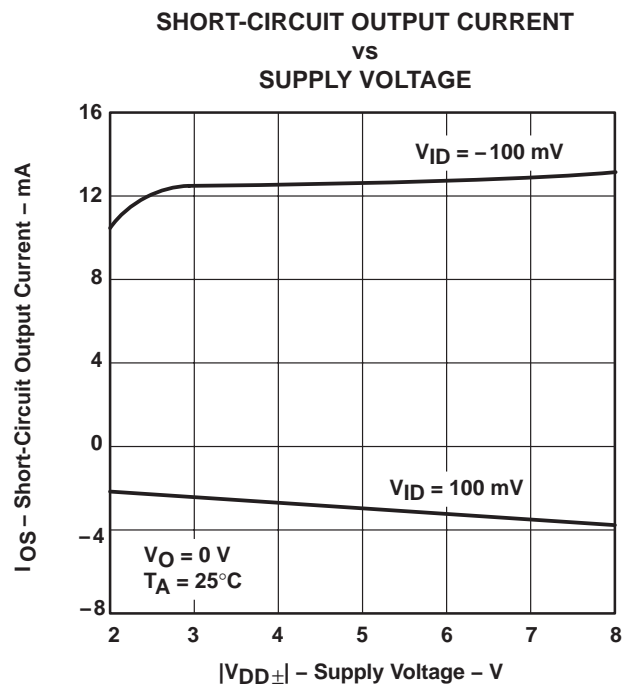

Figure 20

† Data at high and low temperatures are applicable only within the rated operating free-air temperature ranges of the various devices.

TYPICAL CHARACTERISTICS

SHORT-CIRCUIT OUTPUT CURRENT†
vs
FREE-AIR TEMPERATURE

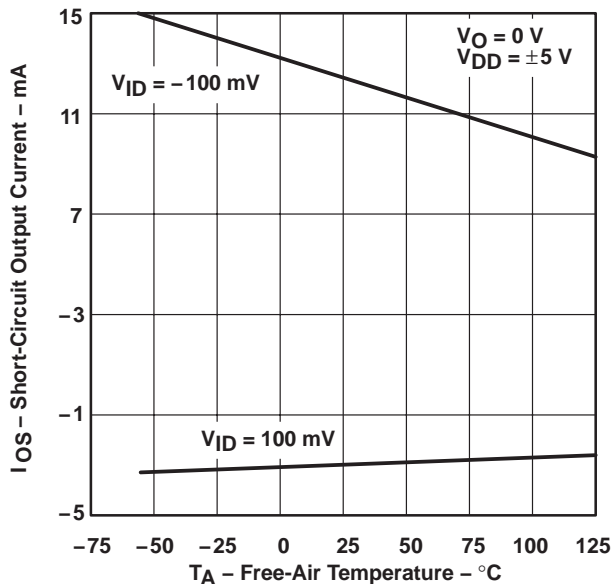

Figure 21

OUTPUT VOLTAGE
vs
DIFFERENTIAL INPUT VOLTAGE

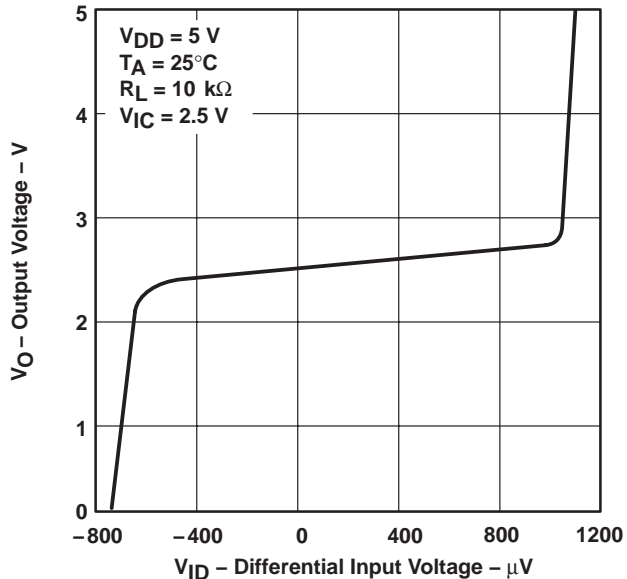

Figure 22

OUTPUT VOLTAGE
vs
DIFFERENTIAL INPUT VOLTAGE

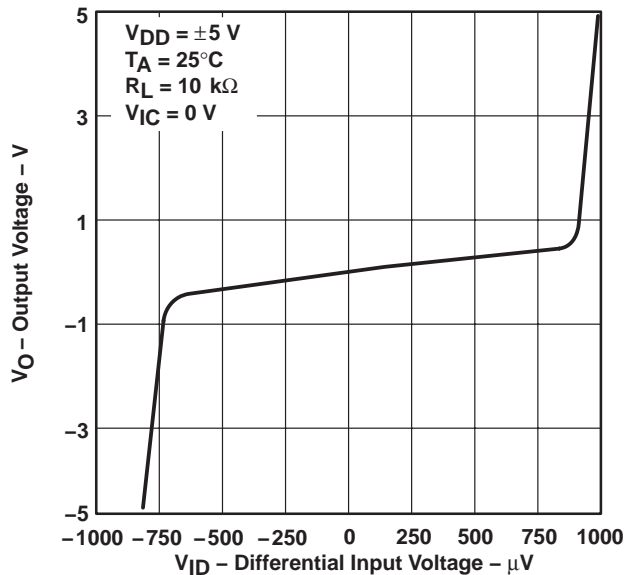

Figure 23

LARGE-SIGNAL DIFFERENTIAL
VOLTAGE AMPLIFICATION
vs
LOAD RESISTANCE



Figure 24

† Data at high and low temperatures are applicable only within the rated operating free-air temperature ranges of the various devices.

TYPICAL CHARACTERISTICS

LARGE-SIGNAL DIFFERENTIAL VOLTAGE
 AMPLIFICATION AND PHASE MARGIN
 vs
 FREQUENCY

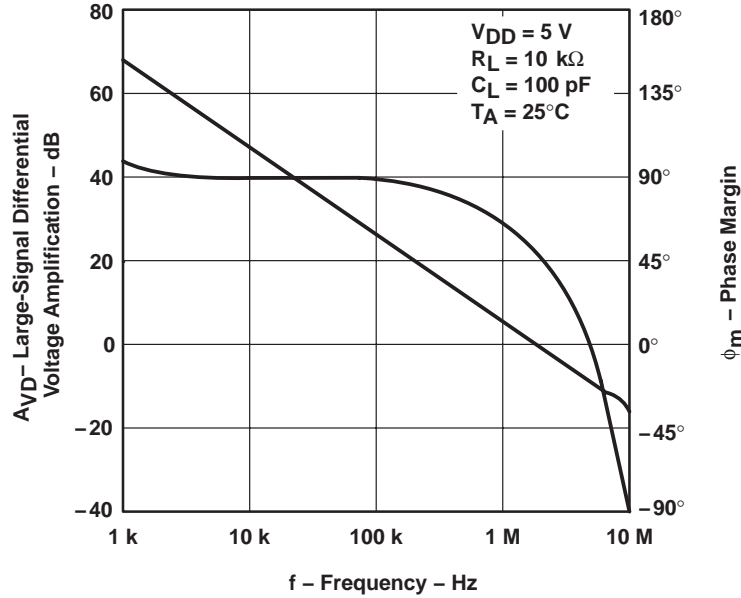

Figure 25

LARGE-SIGNAL DIFFERENTIAL VOLTAGE
 AMPLIFICATION AND PHASE MARGIN
 vs
 FREQUENCY

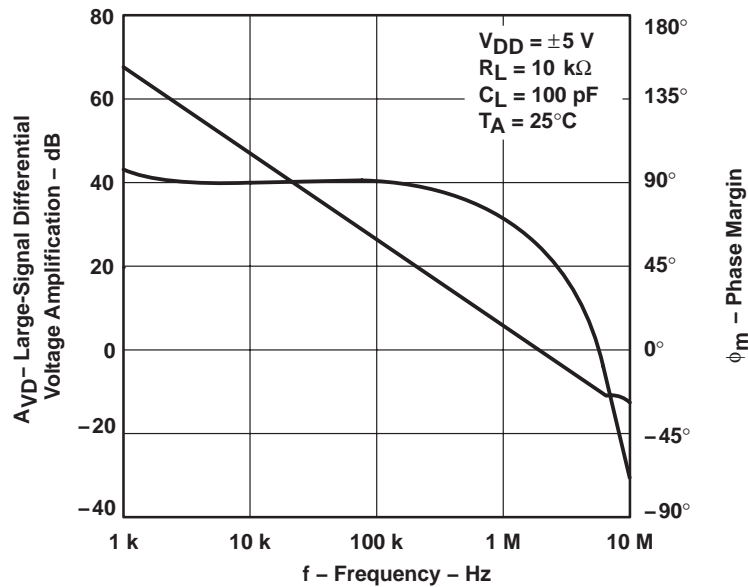

Figure 26

TYPICAL CHARACTERISTICS

LARGE-SIGNAL DIFFERENTIAL VOLTAGE AMPLIFICATION†
vs
FREE-AIR TEMPERATURE

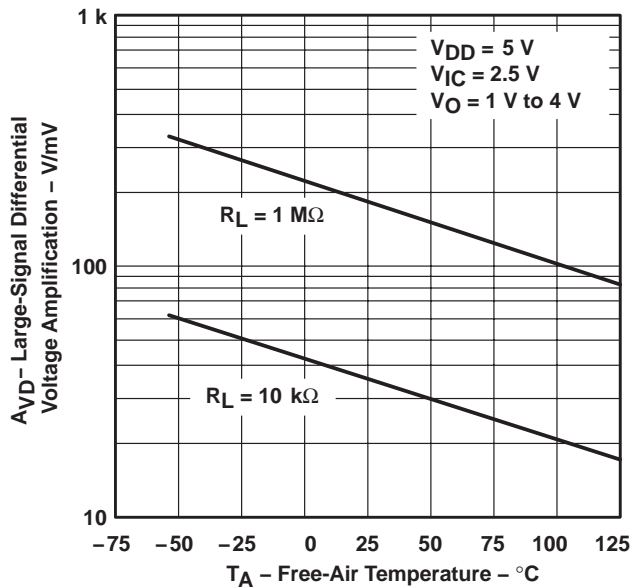

Figure 27

LARGE-SIGNAL DIFFERENTIAL VOLTAGE AMPLIFICATION†
vs
FREE-AIR TEMPERATURE

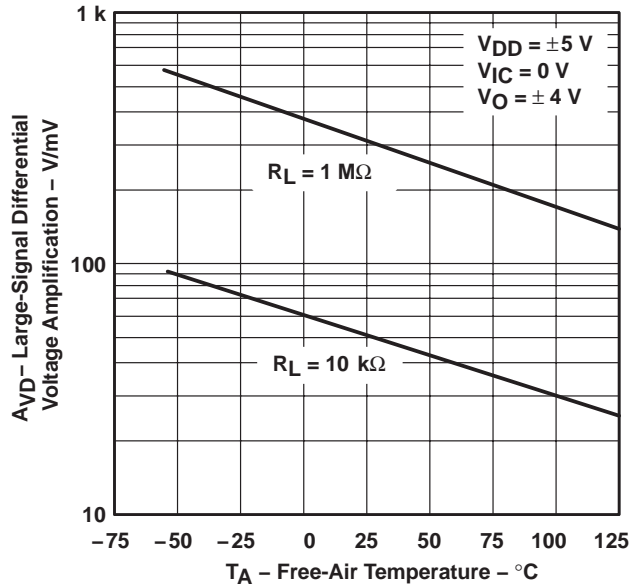

Figure 28

OUTPUT IMPEDANCE
vs
FREQUENCY

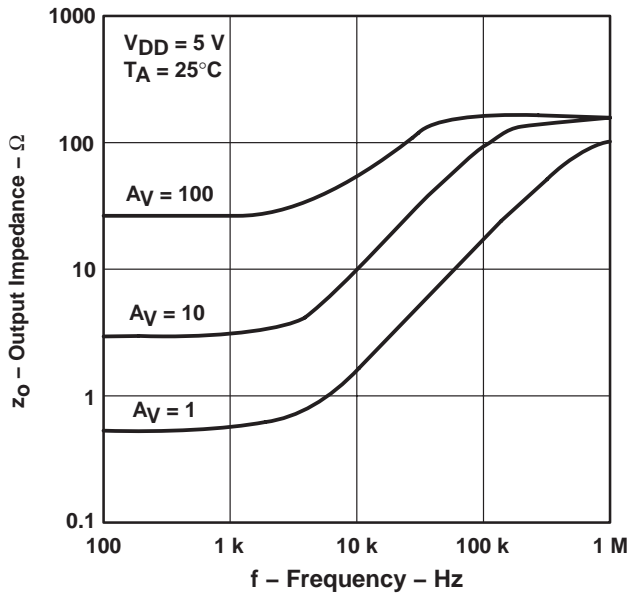

Figure 29

OUTPUT IMPEDANCE
vs
FREQUENCY

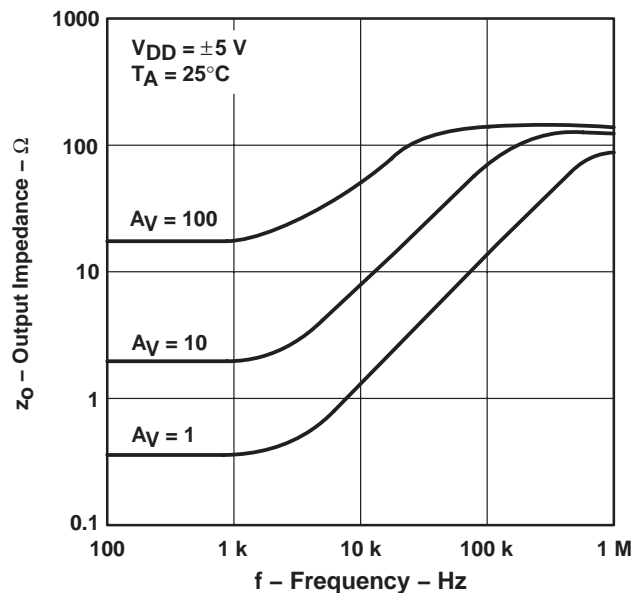

Figure 30

† Data at high and low temperatures are applicable only within the rated operating free-air temperature ranges of the various devices.

TYPICAL CHARACTERISTICS

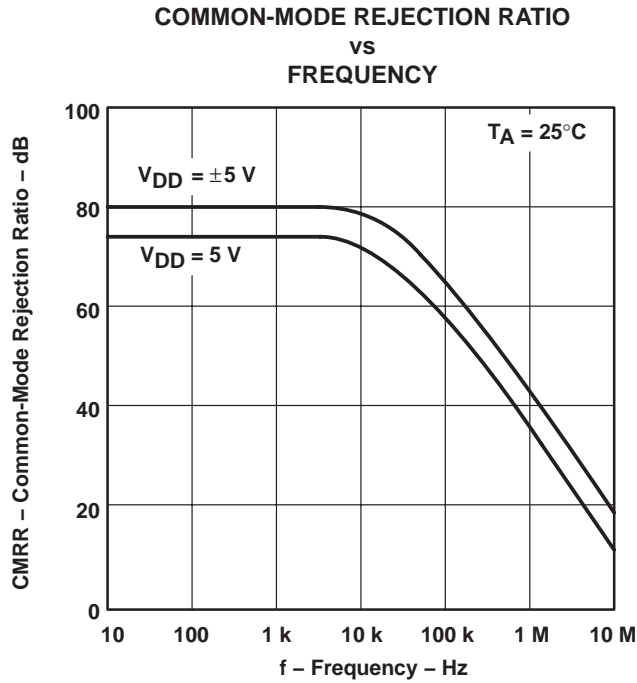

Figure 31

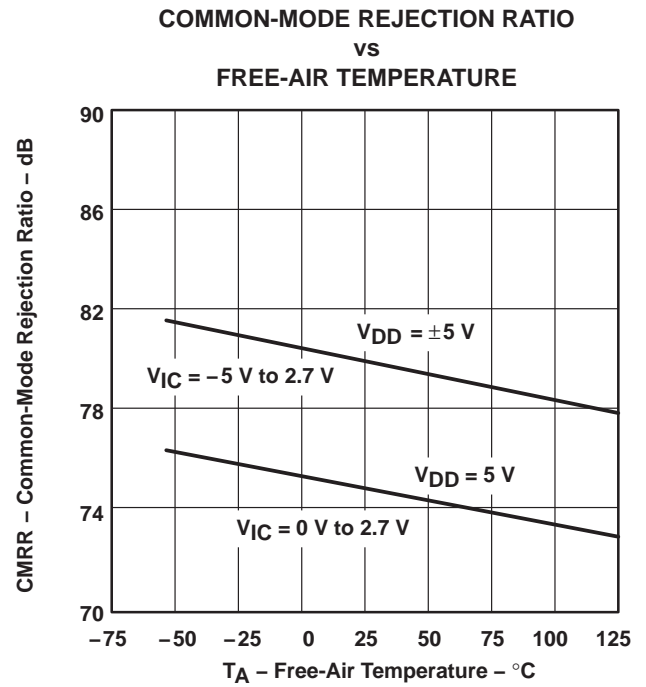

Figure 32

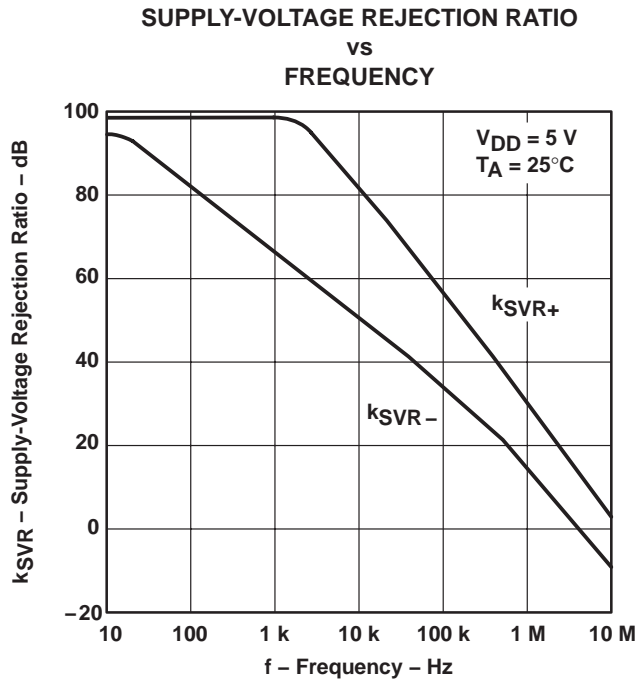

Figure 33

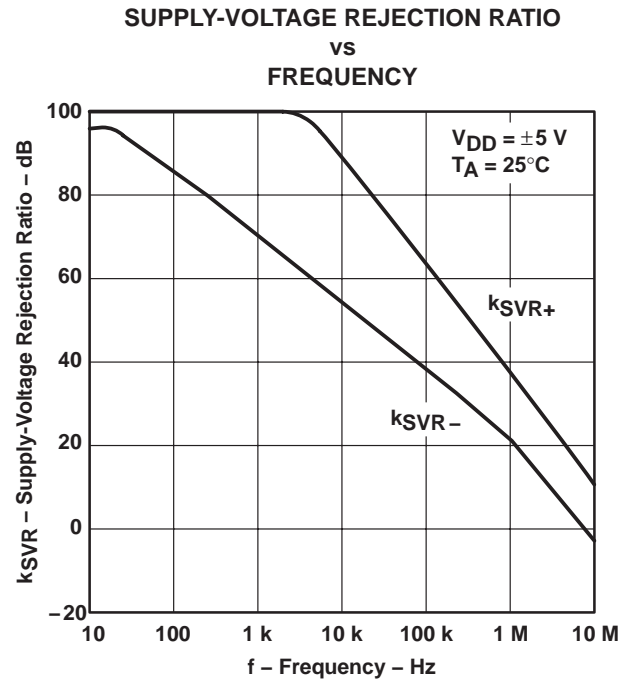

Figure 34

TYPICAL CHARACTERISTICS

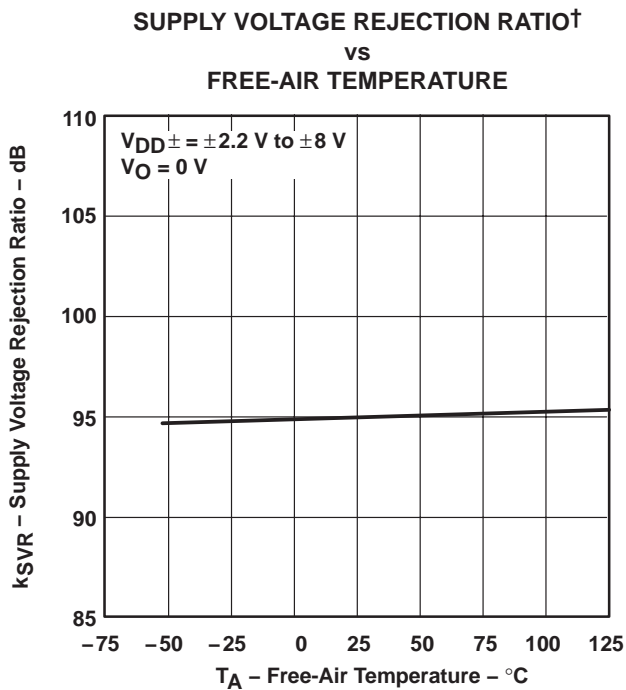

Figure 35

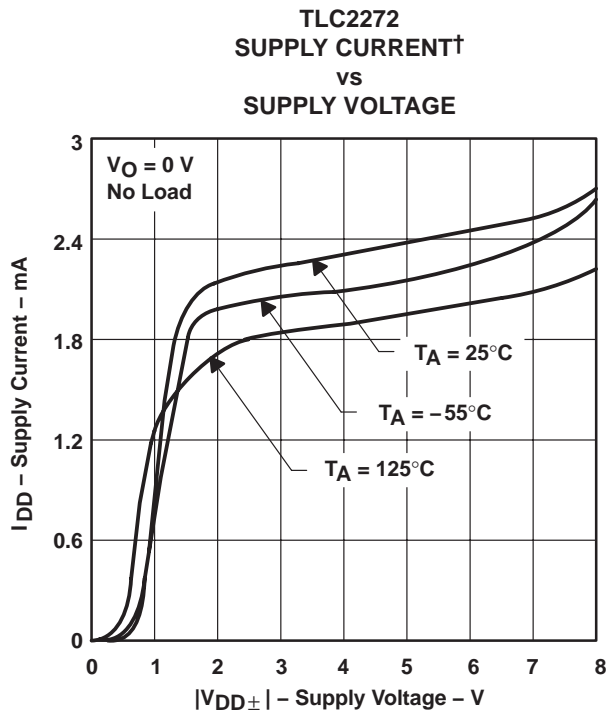

Figure 36

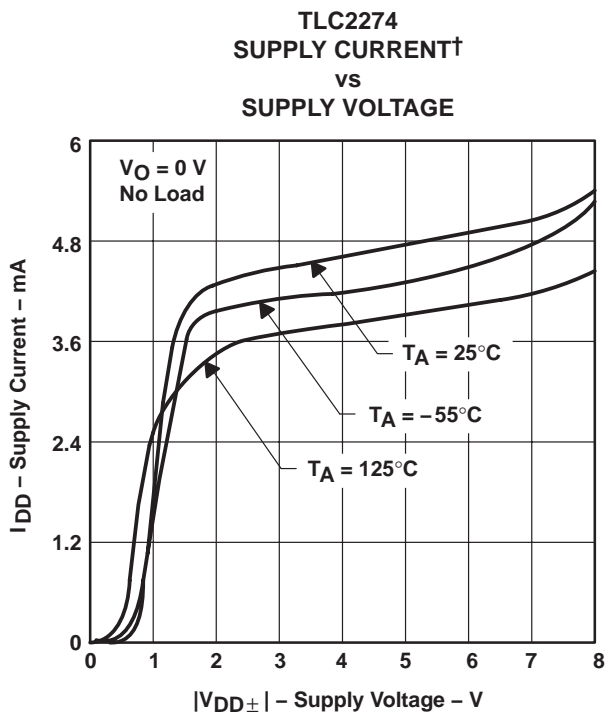

Figure 37

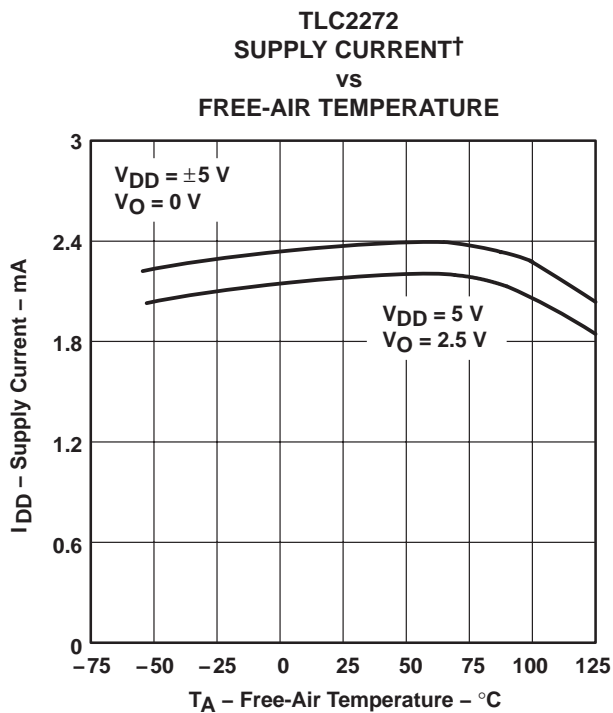

Figure 38

† Data at high and low temperatures are applicable only within the rated operating free-air temperature ranges of the various devices.

TYPICAL CHARACTERISTICS

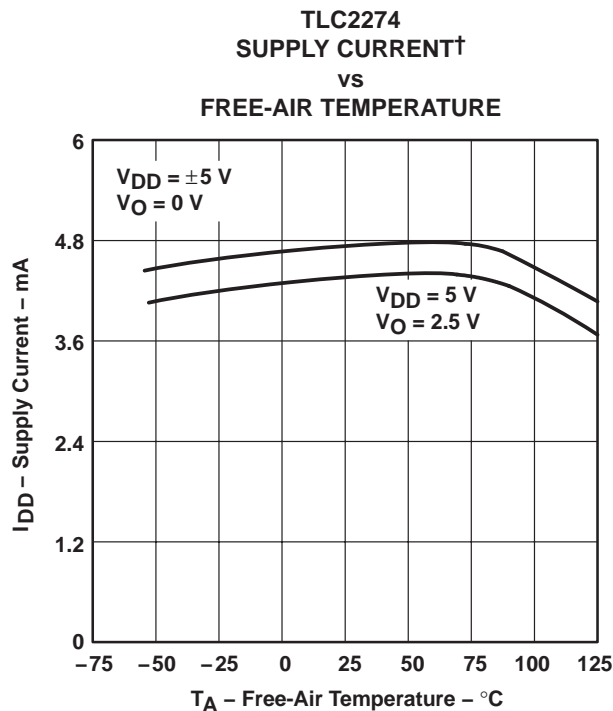

Figure 39

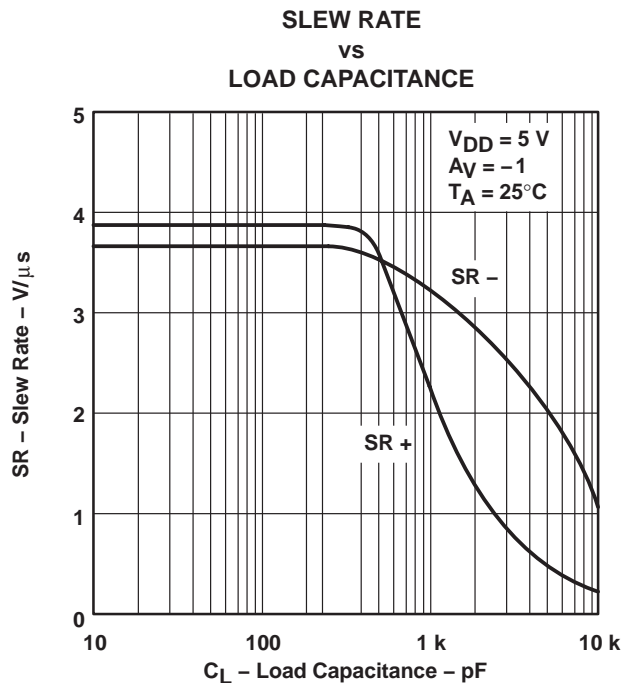

Figure 40

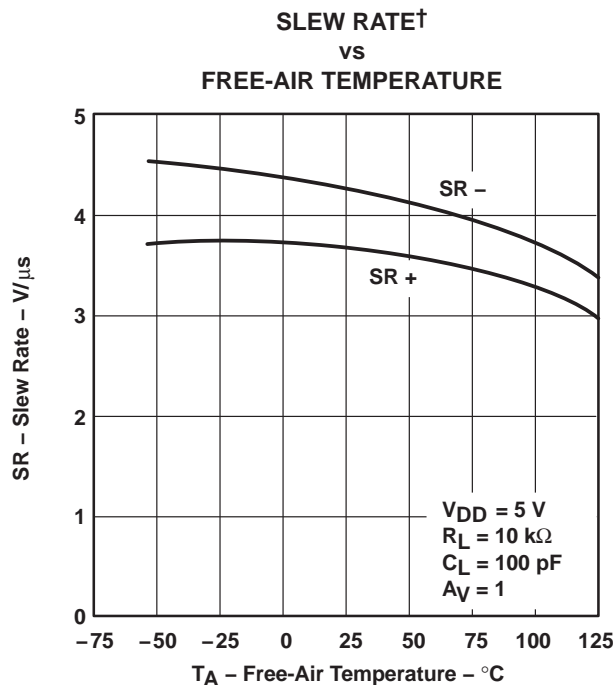

Figure 41

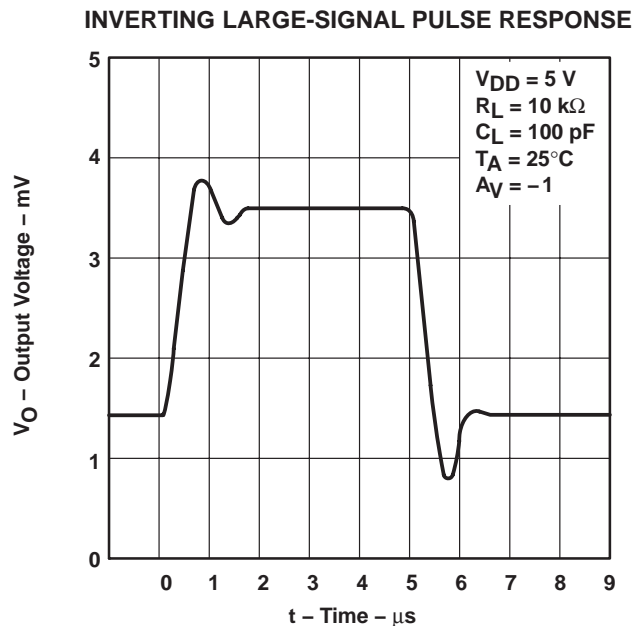

Figure 42

† Data at high and low temperatures are applicable only within the rated operating free-air temperature ranges of the various devices.

TYPICAL CHARACTERISTICS

INVERTING LARGE-SIGNAL PULSE RESPONSE

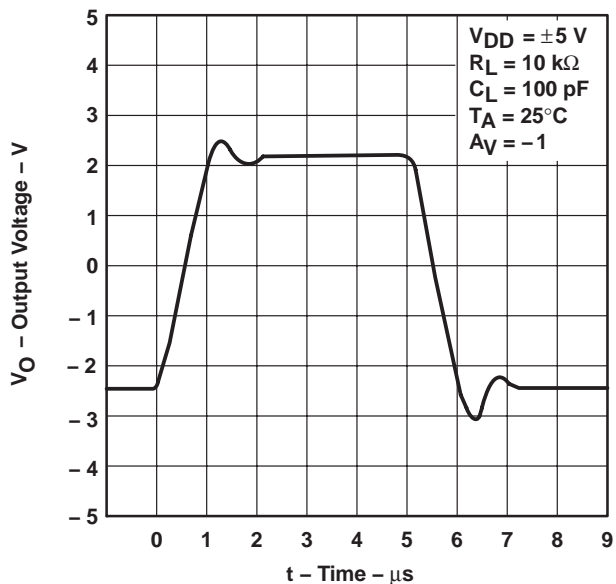

Figure 43

**VOLTAGE-FOLLOWER
 LARGE-SIGNAL PULSE RESPONSE**

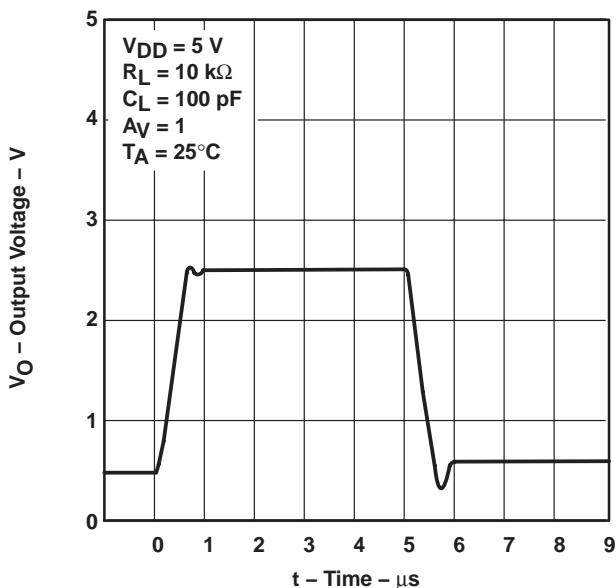

Figure 44

**VOLTAGE-FOLLOWER
 LARGE-SIGNAL PULSE RESPONSE**

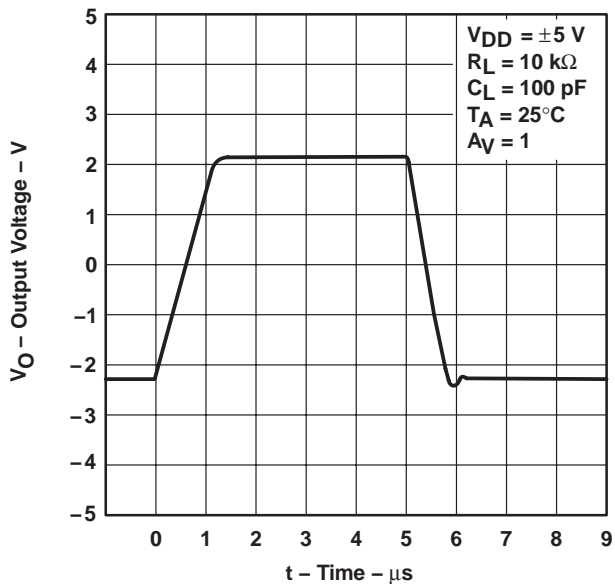

Figure 45

INVERTING SMALL-SIGNAL PULSE RESPONSE



Figure 46

TYPICAL CHARACTERISTICS

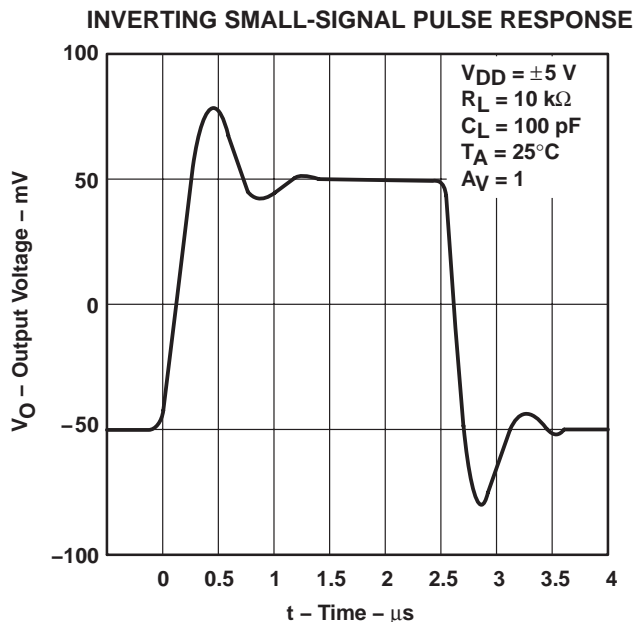

Figure 47

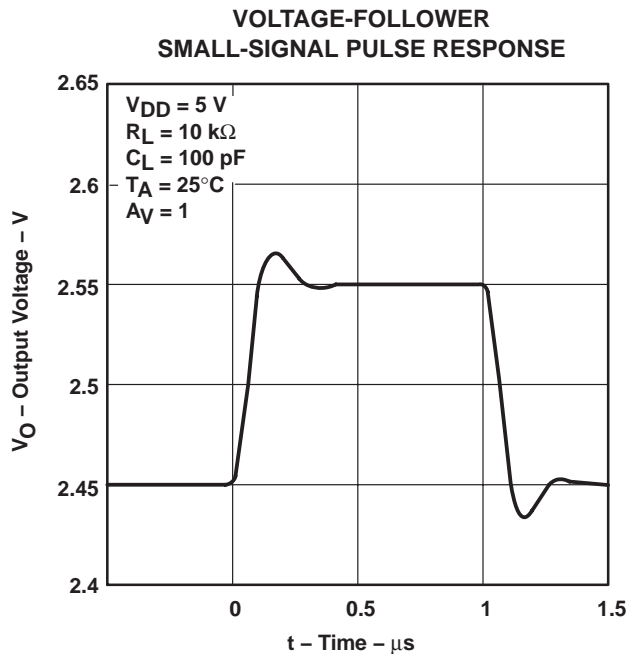

Figure 48

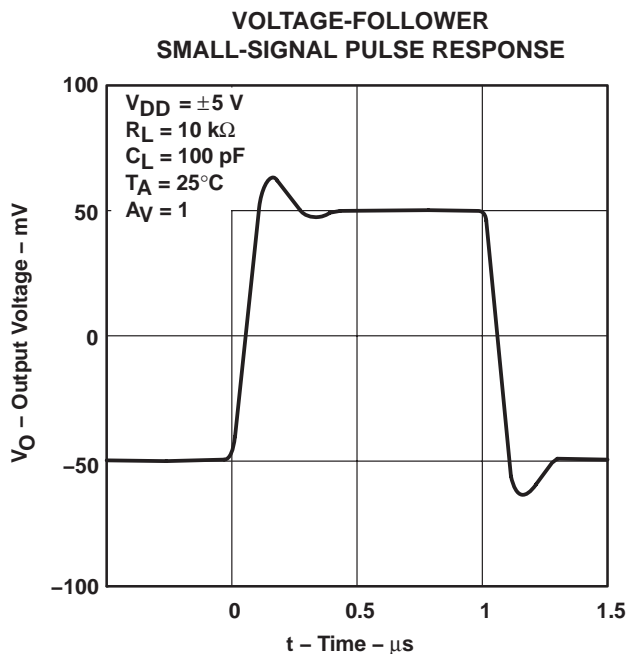

Figure 49

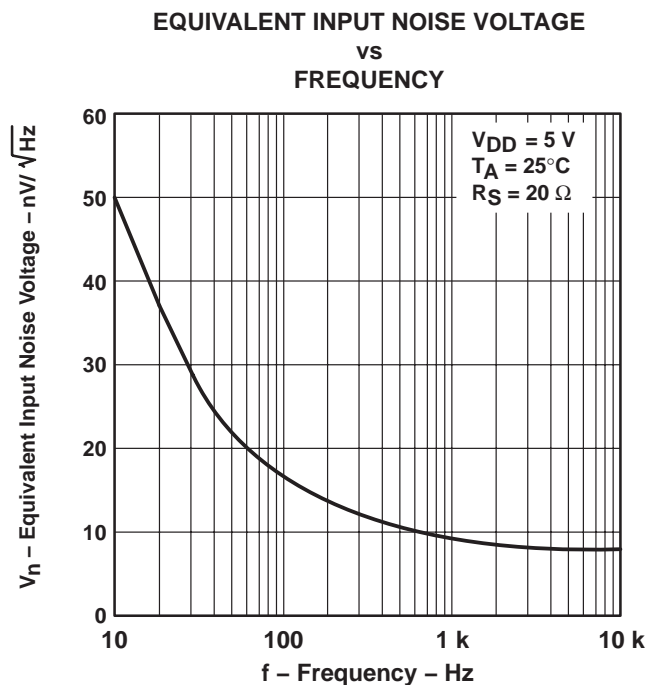

Figure 50

TYPICAL CHARACTERISTICS

**EQUIVALENT INPUT NOISE VOLTAGE
 vs
 FREQUENCY**

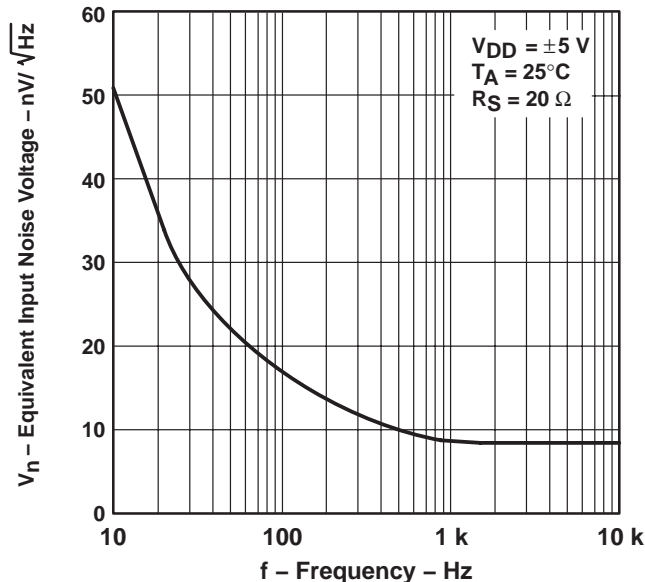

Figure 51

**NOISE VOLTAGE
 OVER A 10 SECOND PERIOD**

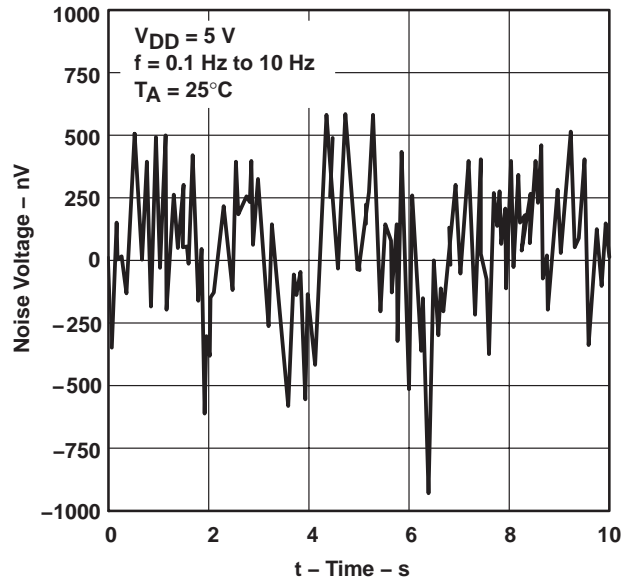

Figure 52

**INTEGRATED NOISE VOLTAGE
 vs
 FREQUENCY**

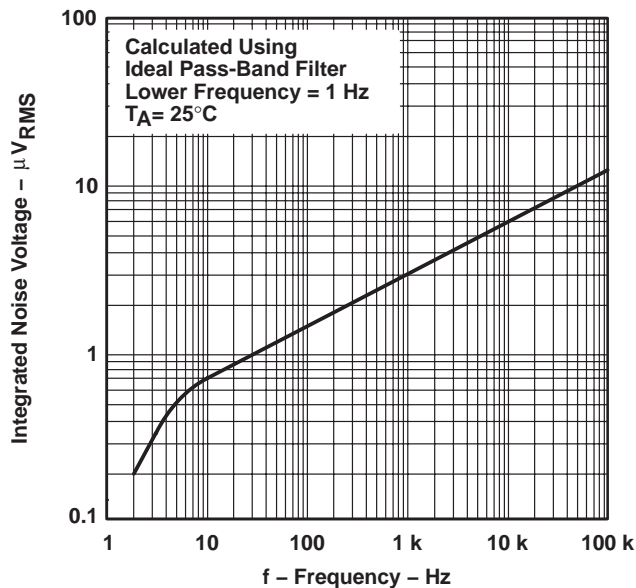

Figure 53

**TOTAL HARMONIC DISTORTION PLUS NOISE
 vs
 FREQUENCY**

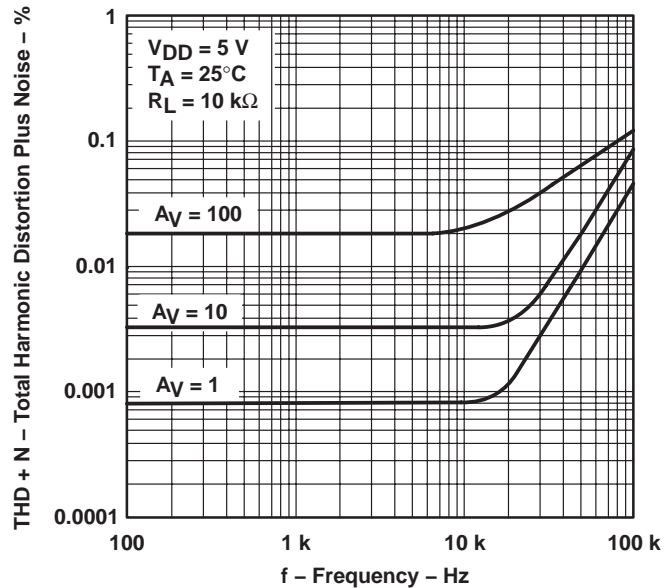

Figure 54

TYPICAL CHARACTERISTICS

GAIN-BANDWIDTH PRODUCT
 VS
 SUPPLY VOLTAGE

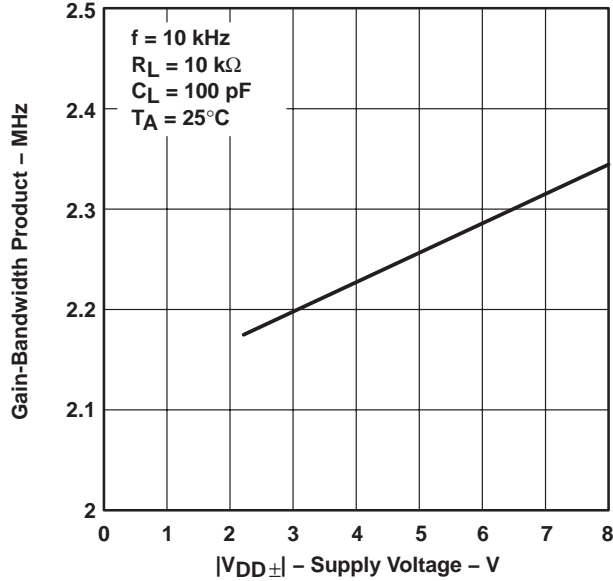

Figure 55

GAIN-BANDWIDTH PRODUCT†
 VS
 FREE-AIR TEMPERATURE

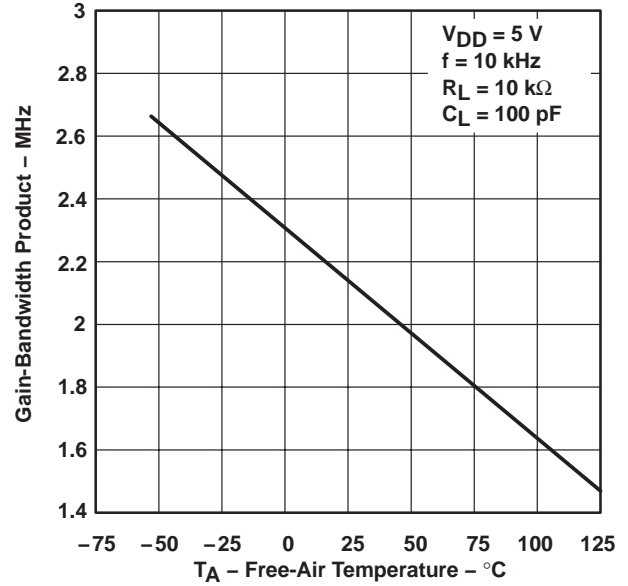

Figure 56

PHASE MARGIN
 VS
 LOAD CAPACITANCE

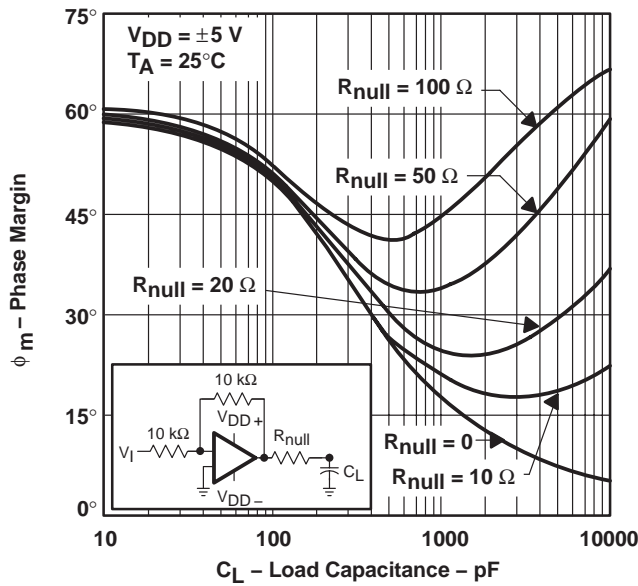

Figure 57

GAIN MARGIN
 VS
 LOAD CAPACITANCE

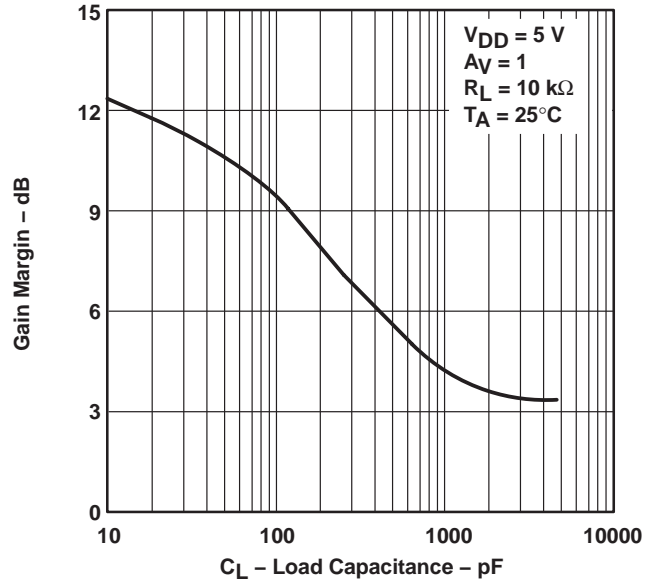

Figure 58

† Data at high and low temperatures are applicable only within the rated operating free-air temperature ranges of the various devices.

TLC227x, TLC227xA Advanced LinCMOS™ RAIL-TO-RAIL OPERATIONAL AMPLIFIERS

SLOS190G – FEBRUARY 1997 – REVISED MAY 2004

APPLICATION INFORMATION

macromodel information

Macromodel information provided was derived using Microsim *Parts*™, the model generation software used with Microsim *PSpice*™. The Boyle macromodel (see Note 5) and subcircuit in Figure 59 were generated using the TLC227x typical electrical and operating characteristics at $T_A = 25^\circ\text{C}$. Using this information, output simulations of the following key parameters can be generated to a tolerance of 20% (in most cases):

- Maximum positive output voltage swing
- Maximum negative output voltage swing
- Slew rate
- Quiescent power dissipation
- Input bias current
- Open-loop voltage amplification
- Unity gain frequency
- Common-mode rejection ratio
- Phase margin
- DC output resistance
- AC output resistance
- Short-circuit output current limit

NOTE 5: G. R. Boyle, B. M. Cohn, D. O. Pederson, and J. E. Solomon, "Macromodeling of Integrated Circuit Operational Amplifiers", *IEEE Journal of Solid-State Circuits*, SC-9, 353 (1974).

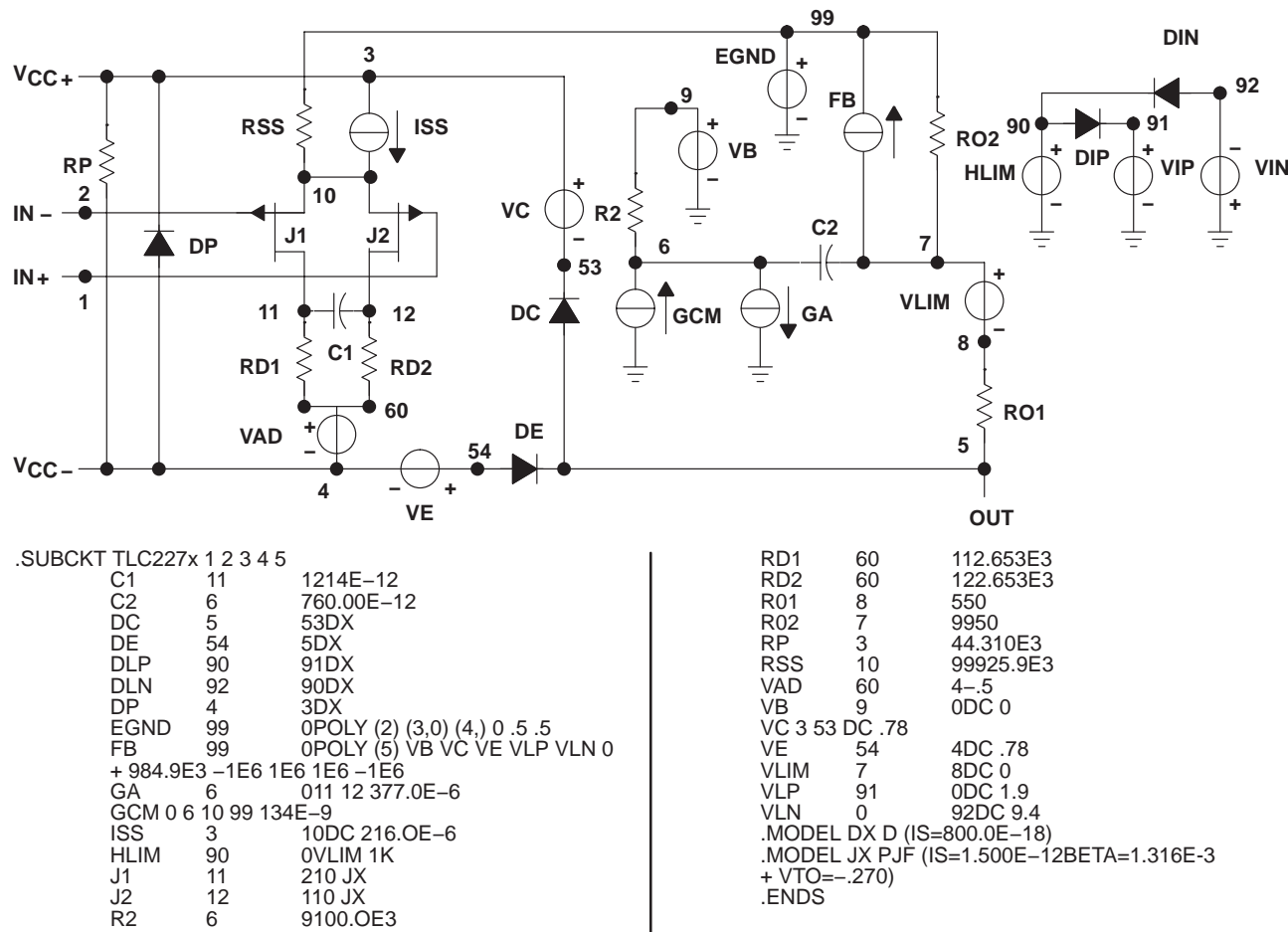

Figure 59. Boyle Macromodel and Subcircuit

PSpice and *Parts* are trademarks of MicroSim Corporation.

Macromodels, simulation models, or other models provided by TI, directly or indirectly, are not warranted by TI as fully representing all of the specification and operating characteristics of the semiconductor product to which the model relates.



POST OFFICE BOX 655303 • DALLAS, TEXAS 75265

PACKAGING INFORMATION

| Orderable Device | Status (1) | Package Type | Package Drawing | Pins | Package Qty | Eco Plan (2) | Lead/Ball Finish (6) | MSL Peak Temp (3) | Op Temp (°C) | Device Marking (4/5) | Samples |
|------------------|---------------|--------------|--------------------|------|----------------|----------------------------|-------------------------|----------------------|--------------|-----------------------------------------|-------------------------|
| 5962-9318201M2A | ACTIVE | LCCC | FK | 20 | 1 | TBD | POST-PLATE | N / A for Pkg Type | -55 to 125 | 5962- 9318201M2A TLC2274 MFKB | Samples |
| 5962-9318201MCA | ACTIVE | CDIP | J | 14 | 1 | TBD | A42 | N / A for Pkg Type | -55 to 125 | 5962-9318201MC A TLC2274MJB | Samples |
| 5962-9318201QDA | ACTIVE | CFP | W | 14 | 1 | TBD | A42 | N / A for Pkg Type | -55 to 125 | 5962-9318201QD A TLC2274MWB | Samples |
| 5962-9318202Q2A | ACTIVE | LCCC | FK | 20 | 1 | TBD | POST-PLATE | N / A for Pkg Type | -55 to 125 | 5962- 9318202Q2A TLC2274 AMFKB | Samples |
| 5962-9318202QCA | ACTIVE | CDIP | J | 14 | 1 | TBD | A42 | N / A for Pkg Type | -55 to 125 | 5962-9318202QC A TLC2274AMJB | Samples |
| 5962-9318202QDA | ACTIVE | CFP | W | 14 | 1 | TBD | A42 | N / A for Pkg Type | -55 to 125 | 5962-9318202QD A TLC2274AMWB | Samples |
| 5962-9555201NXD | ACTIVE | SOIC | D | 8 | 2500 | Green (RoHS & no Sb/Br) | CU NIPDAU | Level-1-260C-UNLIM | -55 to 125 | Q2272M | Samples |
| 5962-9555201NXDR | ACTIVE | SOIC | D | 8 | 2500 | Green (RoHS & no Sb/Br) | CU NIPDAU | Level-1-260C-UNLIM | -55 to 125 | Q2272M | Samples |
| 5962-9555201Q2A | ACTIVE | LCCC | FK | 20 | 1 | TBD | POST-PLATE | N / A for Pkg Type | -55 to 125 | 5962- 9555201Q2A TLC2272 MFKB | Samples |
| 5962-9555201QHA | ACTIVE | CFP | U | 10 | 1 | TBD | A42 | N / A for Pkg Type | -55 to 125 | 9555201QHA TLC2272M | Samples |
| 5962-9555201QPA | ACTIVE | CDIP | JG | 8 | 1 | TBD | A42 | N / A for Pkg Type | -55 to 125 | 9555201QPA TLC2272M | Samples |
| 5962-9555202Q2A | ACTIVE | LCCC | FK | 20 | 1 | TBD | POST-PLATE | N / A for Pkg Type | -55 to 125 | 5962- 9555202Q2A TLC2272 AMFKB | Samples |

| Orderable Device | Status (1) | Package Type | Package Drawing | Pins | Package Qty | Eco Plan (2) | Lead/Ball Finish (6) | MSL Peak Temp (3) | Op Temp (°C) | Device Marking (4/5) | Samples |
|------------------|---------------|--------------|-----------------|------|-------------|----------------------------|-------------------------|----------------------|--------------|-------------------------|-------------------------|
| 5962-9555202QHA | ACTIVE | CFP | U | 10 | 1 | TBD | A42 | N / A for Pkg Type | -55 to 125 | 9555202QHA TLC2272AM | Samples |
| 5962-9555202QPA | ACTIVE | CDIP | JG | 8 | 1 | TBD | A42 | N / A for Pkg Type | -55 to 125 | 9555202QPA TLC2272AM | Samples |
| TLC2272ACD | ACTIVE | SOIC | D | 8 | 75 | Green (RoHS & no Sb/Br) | CU NIPDAU | Level-1-260C-UNLIM | | 2272AC | Samples |
| TLC2272ACDG4 | ACTIVE | SOIC | D | 8 | 75 | Green (RoHS & no Sb/Br) | CU NIPDAU | Level-1-260C-UNLIM | | 2272AC | Samples |
| TLC2272ACDR | ACTIVE | SOIC | D | 8 | 2500 | Green (RoHS & no Sb/Br) | CU NIPDAU | Level-1-260C-UNLIM | | 2272AC | Samples |
| TLC2272ACDRG4 | ACTIVE | SOIC | D | 8 | 2500 | Green (RoHS & no Sb/Br) | CU NIPDAU | Level-1-260C-UNLIM | | 2272AC | Samples |
| TLC2272ACP | ACTIVE | PDIP | P | 8 | 50 | Pb-Free (RoHS) | CU NIPDAU | N / A for Pkg Type | | TLC2272AC | Samples |
| TLC2272ACPE4 | ACTIVE | PDIP | P | 8 | 50 | Pb-Free (RoHS) | CU NIPDAU | N / A for Pkg Type | | TLC2272AC | Samples |
| TLC2272ACPW | ACTIVE | TSSOP | PW | 8 | 150 | Green (RoHS & no Sb/Br) | CU NIPDAU | Level-1-260C-UNLIM | | P2272A | Samples |
| TLC2272ACPWG4 | ACTIVE | TSSOP | PW | 8 | 150 | Green (RoHS & no Sb/Br) | CU NIPDAU | Level-1-260C-UNLIM | | P2272A | Samples |
| TLC2272ACPWLE | OBSOLETE | TSSOP | PW | 8 | | TBD | Call TI | Call TI | | | |
| TLC2272ACPWR | ACTIVE | TSSOP | PW | 8 | 2000 | Green (RoHS & no Sb/Br) | CU NIPDAU | Level-1-260C-UNLIM | | P2272A | Samples |
| TLC2272ACPWRG4 | ACTIVE | TSSOP | PW | 8 | 2000 | Green (RoHS & no Sb/Br) | CU NIPDAU | Level-1-260C-UNLIM | | P2272A | Samples |
| TLC2272AID | ACTIVE | SOIC | D | 8 | 75 | Green (RoHS & no Sb/Br) | CU NIPDAU | Level-1-260C-UNLIM | | 2272AI | Samples |
| TLC2272AIDG4 | ACTIVE | SOIC | D | 8 | 75 | Green (RoHS & no Sb/Br) | CU NIPDAU | Level-1-260C-UNLIM | | 2272AI | Samples |
| TLC2272AIDR | ACTIVE | SOIC | D | 8 | 2500 | Green (RoHS & no Sb/Br) | CU NIPDAU | Level-1-260C-UNLIM | | 2272AI | Samples |
| TLC2272AIDRG4 | ACTIVE | SOIC | D | 8 | 2500 | Green (RoHS & no Sb/Br) | CU NIPDAU | Level-1-260C-UNLIM | | 2272AI | Samples |
| TLC2272AIP | ACTIVE | PDIP | P | 8 | 50 | Pb-Free (RoHS) | CU NIPDAU | N / A for Pkg Type | | TLC2272AI | Samples |

| Orderable Device | Status (1) | Package Type | Package Drawing | Pins | Package Qty | Eco Plan (2) | Lead/Ball Finish (6) | MSL Peak Temp (3) | Op Temp (°C) | Device Marking (4/5) | Samples |
|------------------|---------------|--------------|-----------------|------|-------------|-------------------------|-------------------------|----------------------|--------------|-------------------------------------|-------------------------|
| TLC2272AIPE4 | ACTIVE | PDIP | P | 8 | 50 | Pb-Free (RoHS) | CU NIPDAU | N / A for Pkg Type | | TLC2272AI | Samples |
| TLC2272AMD | ACTIVE | SOIC | D | 8 | 75 | Green (RoHS & no Sb/Br) | CU NIPDAU | Level-1-260C-UNLIM | -55 to 125 | 2272AM | Samples |
| TLC2272AMDG4 | ACTIVE | SOIC | D | 8 | 75 | Green (RoHS & no Sb/Br) | CU NIPDAU | Level-1-260C-UNLIM | | 2272AM | Samples |
| TLC2272AMDR | ACTIVE | SOIC | D | 8 | 2500 | Green (RoHS & no Sb/Br) | CU NIPDAU | Level-1-260C-UNLIM | -55 to 125 | 2272AM | Samples |
| TLC2272AMDRG4 | ACTIVE | SOIC | D | 8 | 2500 | Green (RoHS & no Sb/Br) | CU NIPDAU | Level-1-260C-UNLIM | | 2272AM | Samples |
| TLC2272AMFKB | ACTIVE | LCCC | FK | 20 | 1 | TBD | POST-PLATE | N / A for Pkg Type | -55 to 125 | 5962-9555202Q2A TLC2272 AMFKB | Samples |
| TLC2272AMJGB | ACTIVE | CDIP | JG | 8 | 1 | TBD | A42 | N / A for Pkg Type | -55 to 125 | 9555202QPA TLC2272AM | Samples |
| TLC2272AMP | OBSOLETE | PDIP | P | 8 | | TBD | Call TI | Call TI | -55 to 125 | | |
| TLC2272AMUB | ACTIVE | CFP | U | 10 | 1 | TBD | A42 | N / A for Pkg Type | -55 to 125 | 9555202QHA TLC2272AM | Samples |
| TLC2272AQD | ACTIVE | SOIC | D | 8 | 75 | Green (RoHS & no Sb/Br) | CU NIPDAU | Level-1-260C-UNLIM | -40 to 125 | C2272A | Samples |
| TLC2272AQDG4 | ACTIVE | SOIC | D | 8 | 75 | Green (RoHS & no Sb/Br) | CU NIPDAU | Level-1-260C-UNLIM | | C2272A | Samples |
| TLC2272AQDR | ACTIVE | SOIC | D | 8 | 2500 | Green (RoHS & no Sb/Br) | CU NIPDAU | Level-1-260C-UNLIM | -40 to 125 | C2272A | Samples |
| TLC2272AQDRG4 | ACTIVE | SOIC | D | 8 | 2500 | Green (RoHS & no Sb/Br) | CU NIPDAU | Level-1-260C-UNLIM | | C2272A | Samples |
| TLC2272CD | ACTIVE | SOIC | D | 8 | 75 | Green (RoHS & no Sb/Br) | CU NIPDAU | Level-1-260C-UNLIM | 0 to 70 | 2272C | Samples |
| TLC2272CDG4 | ACTIVE | SOIC | D | 8 | 75 | Green (RoHS & no Sb/Br) | CU NIPDAU | Level-1-260C-UNLIM | 0 to 70 | 2272C | Samples |
| TLC2272CDR | ACTIVE | SOIC | D | 8 | 2500 | Green (RoHS & no Sb/Br) | CU NIPDAU | Level-1-260C-UNLIM | 0 to 70 | 2272C | Samples |
| TLC2272CDRG4 | ACTIVE | SOIC | D | 8 | 2500 | Green (RoHS & no Sb/Br) | CU NIPDAU | Level-1-260C-UNLIM | 0 to 70 | 2272C | Samples |

| Orderable Device | Status (1) | Package Type | Package Drawing | Pins | Package Qty | Eco Plan (2) | Lead/Ball Finish (6) | MSL Peak Temp (3) | Op Temp (°C) | Device Marking (4/5) | Samples |
|------------------|---------------|--------------|--------------------|------|----------------|----------------------------|-------------------------|----------------------|--------------|-------------------------|-------------------------|
| TLC2272CP | ACTIVE | PDIP | P | 8 | 50 | Pb-Free (RoHS) | CU NIPDAU | N / A for Pkg Type | 0 to 70 | TLC2272CP | Samples |
| TLC2272CPE4 | ACTIVE | PDIP | P | 8 | 50 | Pb-Free (RoHS) | CU NIPDAU | N / A for Pkg Type | 0 to 70 | TLC2272CP | Samples |
| TLC2272CPSR | ACTIVE | SO | PS | 8 | 2000 | Green (RoHS & no Sb/Br) | CU NIPDAU | Level-1-260C-UNLIM | 0 to 70 | P2272 | Samples |
| TLC2272CPW | ACTIVE | TSSOP | PW | 8 | 150 | Green (RoHS & no Sb/Br) | CU NIPDAU | Level-1-260C-UNLIM | 0 to 70 | P2272 | Samples |
| TLC2272CPWG4 | ACTIVE | TSSOP | PW | 8 | 150 | Green (RoHS & no Sb/Br) | CU NIPDAU | Level-1-260C-UNLIM | 0 to 70 | P2272 | Samples |
| TLC2272CPWLE | OBSOLETE | TSSOP | PW | 8 | | TBD | Call TI | Call TI | 0 to 70 | | |
| TLC2272CPWR | ACTIVE | TSSOP | PW | 8 | 2000 | Green (RoHS & no Sb/Br) | CU NIPDAU | Level-1-260C-UNLIM | 0 to 70 | P2272 | Samples |
| TLC2272CPWRG4 | ACTIVE | TSSOP | PW | 8 | 2000 | Green (RoHS & no Sb/Br) | CU NIPDAU | Level-1-260C-UNLIM | 0 to 70 | P2272 | Samples |
| TLC2272ID | ACTIVE | SOIC | D | 8 | 75 | Green (RoHS & no Sb/Br) | CU NIPDAU | Level-1-260C-UNLIM | | 2272I | Samples |
| TLC2272IDG4 | ACTIVE | SOIC | D | 8 | 75 | Green (RoHS & no Sb/Br) | CU NIPDAU | Level-1-260C-UNLIM | | 2272I | Samples |
| TLC2272IDR | ACTIVE | SOIC | D | 8 | 2500 | Green (RoHS & no Sb/Br) | CU NIPDAU | Level-1-260C-UNLIM | | 2272I | Samples |
| TLC2272IDRG4 | ACTIVE | SOIC | D | 8 | 2500 | Green (RoHS & no Sb/Br) | CU NIPDAU | Level-1-260C-UNLIM | | 2272I | Samples |
| TLC2272IP | ACTIVE | PDIP | P | 8 | 50 | Pb-Free (RoHS) | CU NIPDAU | N / A for Pkg Type | | TLC2272IP | Samples |
| TLC2272IPE4 | ACTIVE | PDIP | P | 8 | 50 | Pb-Free (RoHS) | CU NIPDAU | N / A for Pkg Type | | TLC2272IP | Samples |
| TLC2272IPW | ACTIVE | TSSOP | PW | 8 | 150 | Green (RoHS & no Sb/Br) | CU NIPDAU | Level-1-260C-UNLIM | | Y2272 | Samples |
| TLC2272IPWG4 | ACTIVE | TSSOP | PW | 8 | 150 | Green (RoHS & no Sb/Br) | CU NIPDAU | Level-1-260C-UNLIM | | Y2272 | Samples |
| TLC2272IPWLE | OBSOLETE | TSSOP | PW | 8 | | TBD | Call TI | Call TI | | | |
| TLC2272IPWR | ACTIVE | TSSOP | PW | 8 | 2000 | Green (RoHS & no Sb/Br) | CU NIPDAU | Level-1-260C-UNLIM | | Y2272 | Samples |
| TLC2272IPWRG4 | ACTIVE | TSSOP | PW | 8 | 2000 | Green (RoHS & no Sb/Br) | CU NIPDAU | Level-1-260C-UNLIM | | Y2272 | Samples |

| Orderable Device | Status (1) | Package Type | Package Drawing | Pins | Package Qty | Eco Plan (2) | Lead/Ball Finish (6) | MSL Peak Temp (3) | Op Temp (°C) | Device Marking (4/5) | Samples |
|------------------|---------------|--------------|--------------------|------|----------------|----------------------------|-------------------------|----------------------|--------------|----------------------------------------|-------------------------|
| TLC2272MD | ACTIVE | SOIC | D | 8 | 75 | Green (RoHS & no Sb/Br) | CU NIPDAU | Level-1-260C-UNLIM | -55 to 125 | 2272M | Samples |
| TLC2272MDG4 | ACTIVE | SOIC | D | 8 | 75 | Green (RoHS & no Sb/Br) | CU NIPDAU | Level-1-260C-UNLIM | | 2272M | Samples |
| TLC2272MDR | ACTIVE | SOIC | D | 8 | 2500 | Green (RoHS & no Sb/Br) | CU NIPDAU | Level-1-260C-UNLIM | -55 to 125 | 2272M | Samples |
| TLC2272MDRG4 | ACTIVE | SOIC | D | 8 | 2500 | Green (RoHS & no Sb/Br) | CU NIPDAU | Level-1-260C-UNLIM | | 2272M | Samples |
| TLC2272MFKB | ACTIVE | LCCC | FK | 20 | 1 | TBD | POST-PLATE | N / A for Pkg Type | -55 to 125 | 5962- 9555201Q2A TLC2272 MFKB | Samples |
| TLC2272MJG | ACTIVE | CDIP | JG | 8 | 1 | TBD | A42 | N / A for Pkg Type | -55 to 125 | TLC2272MJG | Samples |
| TLC2272MJGB | ACTIVE | CDIP | JG | 8 | 1 | TBD | A42 | N / A for Pkg Type | -55 to 125 | 9555201QPA TLC2272M | Samples |
| TLC2272MP | OBSOLETE | PDIP | P | 8 | | TBD | Call TI | Call TI | -55 to 125 | | |
| TLC2272MUB | ACTIVE | CFP | U | 10 | 1 | TBD | A42 | N / A for Pkg Type | -55 to 125 | 9555201QHA TLC2272M | Samples |
| TLC2272QDG4 | ACTIVE | SOIC | D | 8 | 75 | Green (RoHS & no Sb/Br) | CU NIPDAU | Level-1-260C-UNLIM | | C2272Q | Samples |
| TLC2272QDR | ACTIVE | SOIC | D | 8 | 2500 | Green (RoHS & no Sb/Br) | CU NIPDAU | Level-1-260C-UNLIM | -40 to 125 | C2272Q | Samples |
| TLC2272QPWRG4 | ACTIVE | TSSOP | PW | 8 | 2000 | Green (RoHS & no Sb/Br) | CU NIPDAU | Level-1-260C-UNLIM | | T2272Q | Samples |
| TLC2274ACD | ACTIVE | SOIC | D | 14 | 50 | Green (RoHS & no Sb/Br) | CU NIPDAU | Level-1-260C-UNLIM | 0 to 70 | 2274AC | Samples |
| TLC2274ACDG4 | ACTIVE | SOIC | D | 14 | 50 | Green (RoHS & no Sb/Br) | CU NIPDAU | Level-1-260C-UNLIM | 0 to 70 | 2274AC | Samples |
| TLC2274ACDR | ACTIVE | SOIC | D | 14 | 2500 | Green (RoHS & no Sb/Br) | CU NIPDAU | Level-1-260C-UNLIM | 0 to 70 | 2274AC | Samples |
| TLC2274ACDRG4 | ACTIVE | SOIC | D | 14 | 2500 | Green (RoHS & no Sb/Br) | CU NIPDAU | Level-1-260C-UNLIM | 0 to 70 | 2274AC | Samples |
| TLC2274ACN | ACTIVE | PDIP | N | 14 | 25 | Pb-Free (RoHS) | CU NIPDAU | N / A for Pkg Type | 0 to 70 | TLC2274ACN | Samples |
| TLC2274ACNE4 | ACTIVE | PDIP | N | 14 | 25 | Pb-Free (RoHS) | CU NIPDAU | N / A for Pkg Type | 0 to 70 | TLC2274ACN | Samples |

| Orderable Device | Status (1) | Package Type | Package Drawing | Pins | Package Qty | Eco Plan (2) | Lead/Ball Finish (6) | MSL Peak Temp (3) | Op Temp (°C) | Device Marking (4/5) | Samples |
|------------------|---------------|--------------|-----------------|------|-------------|-------------------------|-------------------------|----------------------|--------------|-------------------------|-------------------------|
| TLC2274ACPW | ACTIVE | TSSOP | PW | 14 | 90 | Green (RoHS & no Sb/Br) | CU NIPDAU | Level-1-260C-UNLIM | 0 to 70 | P2274A | Samples |
| TLC2274ACPWG4 | ACTIVE | TSSOP | PW | 14 | 90 | Green (RoHS & no Sb/Br) | CU NIPDAU | Level-1-260C-UNLIM | 0 to 70 | P2274A | Samples |
| TLC2274ACPWR | ACTIVE | TSSOP | PW | 14 | 2000 | Green (RoHS & no Sb/Br) | CU NIPDAU | Level-1-260C-UNLIM | 0 to 70 | P2274A | Samples |
| TLC2274ACPWRG4 | ACTIVE | TSSOP | PW | 14 | 2000 | Green (RoHS & no Sb/Br) | CU NIPDAU | Level-1-260C-UNLIM | 0 to 70 | P2274A | Samples |
| TLC2274AID | ACTIVE | SOIC | D | 14 | 50 | Green (RoHS & no Sb/Br) | CU NIPDAU | Level-1-260C-UNLIM | -40 to 125 | 2274AI | Samples |
| TLC2274AIDG4 | ACTIVE | SOIC | D | 14 | 50 | Green (RoHS & no Sb/Br) | CU NIPDAU | Level-1-260C-UNLIM | -40 to 125 | 2274AI | Samples |
| TLC2274AIDR | ACTIVE | SOIC | D | 14 | 2500 | Green (RoHS & no Sb/Br) | CU NIPDAU | Level-1-260C-UNLIM | -40 to 125 | 2274AI | Samples |
| TLC2274AIDRG4 | ACTIVE | SOIC | D | 14 | 2500 | Green (RoHS & no Sb/Br) | CU NIPDAU | Level-1-260C-UNLIM | -40 to 125 | 2274AI | Samples |
| TLC2274AIN | ACTIVE | PDIP | N | 14 | 25 | Pb-Free (RoHS) | CU NIPDAU | N / A for Pkg Type | -40 to 125 | TLC2274AIN | Samples |
| TLC2274AINE4 | ACTIVE | PDIP | N | 14 | 25 | Pb-Free (RoHS) | CU NIPDAU | N / A for Pkg Type | -40 to 125 | TLC2274AIN | Samples |
| TLC2274AIPW | ACTIVE | TSSOP | PW | 14 | 90 | Green (RoHS & no Sb/Br) | CU NIPDAU | Level-1-260C-UNLIM | -40 to 125 | Y2274A | Samples |
| TLC2274AIPWG4 | ACTIVE | TSSOP | PW | 14 | 90 | Green (RoHS & no Sb/Br) | CU NIPDAU | Level-1-260C-UNLIM | -40 to 125 | Y2274A | Samples |
| TLC2274AIPWLE | OBSOLETE | TSSOP | PW | 14 | | TBD | Call TI | Call TI | -40 to 125 | | |
| TLC2274AIPWR | ACTIVE | TSSOP | PW | 14 | 2000 | Green (RoHS & no Sb/Br) | CU NIPDAU | Level-1-260C-UNLIM | -40 to 125 | Y2274A | Samples |
| TLC2274AIPWRG4 | ACTIVE | TSSOP | PW | 14 | 2000 | Green (RoHS & no Sb/Br) | CU NIPDAU | Level-1-260C-UNLIM | -40 to 125 | Y2274A | Samples |
| TLC2274AMD | ACTIVE | SOIC | D | 14 | 50 | Green (RoHS & no Sb/Br) | CU NIPDAU | Level-1-260C-UNLIM | -55 to 125 | 2274AM | Samples |
| TLC2274AMDG4 | ACTIVE | SOIC | D | 14 | 50 | Green (RoHS & no Sb/Br) | CU NIPDAU | Level-1-260C-UNLIM | | 2274AM | Samples |
| TLC2274AMDR | OBSOLETE | SOIC | D | 14 | | TBD | Call TI | Call TI | -55 to 125 | | |
| TLC2274AMDRG4 | ACTIVE | SOIC | D | 14 | 2500 | Green (RoHS & no Sb/Br) | CU NIPDAU | Level-1-260C-UNLIM | | 2274AM | Samples |

| Orderable Device | Status (1) | Package Type | Package Drawing | Pins | Package Qty | Eco Plan (2) | Lead/Ball Finish (6) | MSL Peak Temp (3) | Op Temp (°C) | Device Marking (4/5) | Samples |
|------------------|---------------|--------------|-----------------|------|-------------|-------------------------|-------------------------|----------------------|--------------|-------------------------------------|-------------------------|
| TLC2274AMFKB | ACTIVE | LCCC | FK | 20 | 1 | TBD | POST-PLATE | N / A for Pkg Type | -55 to 125 | 5962-9318202Q2A TLC2274 AMFKB | Samples |
| TLC2274AMJB | ACTIVE | CDIP | J | 14 | 1 | TBD | A42 | N / A for Pkg Type | -55 to 125 | 5962-9318202QC A TLC2274AMJB | Samples |
| TLC2274AMWB | ACTIVE | CFP | W | 14 | 1 | TBD | A42 | N / A for Pkg Type | -55 to 125 | 5962-9318202QD A TLC2274AMWB | Samples |
| TLC2274AQD | ACTIVE | SOIC | D | 14 | 50 | Green (RoHS & no Sb/Br) | CU NIPDAU | Level-1-260C-UNLIM | -40 to 125 | TLC2274A | Samples |
| TLC2274AQDG4 | ACTIVE | SOIC | D | 14 | 50 | Green (RoHS & no Sb/Br) | CU NIPDAU | Level-1-260C-UNLIM | | PJ2274A | Samples |
| TLC2274AQDR | ACTIVE | SOIC | D | 14 | 2500 | Green (RoHS & no Sb/Br) | CU NIPDAU | Level-1-260C-UNLIM | -40 to 125 | TLC2274A | Samples |
| TLC2274AQDRG4 | ACTIVE | SOIC | D | 14 | 2500 | Green (RoHS & no Sb/Br) | CU NIPDAU | Level-1-260C-UNLIM | | PJ2274A | Samples |
| TLC2274CD | ACTIVE | SOIC | D | 14 | 50 | Green (RoHS & no Sb/Br) | CU NIPDAU | Level-1-260C-UNLIM | | TLC2274C | Samples |
| TLC2274CDG4 | ACTIVE | SOIC | D | 14 | 50 | Green (RoHS & no Sb/Br) | CU NIPDAU | Level-1-260C-UNLIM | | TLC2274C | Samples |
| TLC2274CDR | ACTIVE | SOIC | D | 14 | 2500 | Green (RoHS & no Sb/Br) | CU NIPDAU | Level-1-260C-UNLIM | | TLC2274C | Samples |
| TLC2274CDRG4 | ACTIVE | SOIC | D | 14 | 2500 | Green (RoHS & no Sb/Br) | CU NIPDAU | Level-1-260C-UNLIM | | TLC2274C | Samples |
| TLC2274CN | ACTIVE | PDIP | N | 14 | 25 | Pb-Free (RoHS) | CU NIPDAU | N / A for Pkg Type | | TLC2274CN | Samples |
| TLC2274CNE4 | ACTIVE | PDIP | N | 14 | 25 | Pb-Free (RoHS) | CU NIPDAU | N / A for Pkg Type | | TLC2274CN | Samples |
| TLC2274CNSR | ACTIVE | SO | NS | 14 | 2000 | Green (RoHS & no Sb/Br) | CU NIPDAU | Level-1-260C-UNLIM | | TLC2274 | Samples |
| TLC2274CPW | ACTIVE | TSSOP | PW | 14 | 90 | Green (RoHS & no Sb/Br) | CU NIPDAU | Level-1-260C-UNLIM | | P2274 | Samples |
| TLC2274CPWG4 | ACTIVE | TSSOP | PW | 14 | 90 | Green (RoHS & no Sb/Br) | CU NIPDAU | Level-1-260C-UNLIM | | P2274 | Samples |
| TLC2274CPWLE | OBSOLETE | TSSOP | PW | 14 | | TBD | Call TI | Call TI | | | |

| Orderable Device | Status (1) | Package Type | Package Drawing | Pins | Package Qty | Eco Plan (2) | Lead/Ball Finish (6) | MSL Peak Temp (3) | Op Temp (°C) | Device Marking (4/5) | Samples |
|------------------|---------------|--------------|--------------------|------|----------------|----------------------------|-------------------------|----------------------|--------------|----------------------------------------|-------------------------|
| TLC2274CPWR | ACTIVE | TSSOP | PW | 14 | 2000 | Green (RoHS & no Sb/Br) | CU NIPDAU | Level-1-260C-UNLIM | | P2274 | Samples |
| TLC2274CPWRG4 | ACTIVE | TSSOP | PW | 14 | 2000 | Green (RoHS & no Sb/Br) | CU NIPDAU | Level-1-260C-UNLIM | 0 to 70 | P2274 | Samples |
| TLC2274ID | ACTIVE | SOIC | D | 14 | 50 | Green (RoHS & no Sb/Br) | CU NIPDAU | Level-1-260C-UNLIM | | TLC2274I | Samples |
| TLC2274IDG4 | ACTIVE | SOIC | D | 14 | 50 | Green (RoHS & no Sb/Br) | CU NIPDAU | Level-1-260C-UNLIM | | TLC2274I | Samples |
| TLC2274IDR | ACTIVE | SOIC | D | 14 | 2500 | Green (RoHS & no Sb/Br) | CU NIPDAU | Level-1-260C-UNLIM | | TLC2274I | Samples |
| TLC2274IDRG4 | ACTIVE | SOIC | D | 14 | 2500 | Green (RoHS & no Sb/Br) | CU NIPDAU | Level-1-260C-UNLIM | | TLC2274I | Samples |
| TLC2274IN | ACTIVE | PDIP | N | 14 | 25 | Pb-Free (RoHS) | CU NIPDAU | N / A for Pkg Type | | TLC2274IN | Samples |
| TLC2274IPW | ACTIVE | TSSOP | PW | 14 | 90 | Green (RoHS & no Sb/Br) | CU NIPDAU | Level-1-260C-UNLIM | | Y2274 | Samples |
| TLC2274IPWG4 | ACTIVE | TSSOP | PW | 14 | 90 | Green (RoHS & no Sb/Br) | CU NIPDAU | Level-1-260C-UNLIM | | Y2274 | Samples |
| TLC2274IPWLE | OBSOLETE | TSSOP | PW | 14 | | TBD | Call TI | Call TI | | | |
| TLC2274IPWR | ACTIVE | TSSOP | PW | 14 | 2000 | Green (RoHS & no Sb/Br) | CU NIPDAU | Level-1-260C-UNLIM | | Y2274 | Samples |
| TLC2274IPWRG4 | ACTIVE | TSSOP | PW | 14 | 2000 | Green (RoHS & no Sb/Br) | CU NIPDAU | Level-1-260C-UNLIM | | Y2274 | Samples |
| TLC2274MD | ACTIVE | SOIC | D | 14 | 50 | Green (RoHS & no Sb/Br) | CU NIPDAU | Level-1-260C-UNLIM | -55 to 125 | TLC2274M | Samples |
| TLC2274MDG4 | ACTIVE | SOIC | D | 14 | 50 | Green (RoHS & no Sb/Br) | CU NIPDAU | Level-1-260C-UNLIM | | PJ2274M | Samples |
| TLC2274MDR | ACTIVE | SOIC | D | 14 | 2500 | Green (RoHS & no Sb/Br) | CU NIPDAU | Level-1-260C-UNLIM | -55 to 125 | TLC2274M | Samples |
| TLC2274MDRG4 | ACTIVE | SOIC | D | 14 | 2500 | Green (RoHS & no Sb/Br) | CU NIPDAU | Level-1-260C-UNLIM | | PJ2274M | Samples |
| TLC2274MFKB | ACTIVE | LCCC | FK | 20 | 1 | TBD | POST-PLATE | N / A for Pkg Type | -55 to 125 | 5962- 9318201M2A TLC2274 MFKB | Samples |
| TLC2274MJ | ACTIVE | CDIP | J | 14 | 1 | TBD | A42 | N / A for Pkg Type | -55 to 125 | TLC2274MJ | Samples |

| Orderable Device | Status (1) | Package Type | Package Drawing | Pins | Package Qty | Eco Plan (2) | Lead/Ball Finish (6) | MSL Peak Temp (3) | Op Temp (°C) | Device Marking (4/5) | Samples |
|------------------|---------------|--------------|-----------------|------|-------------|-------------------------|-------------------------|----------------------|--------------|-----------------------------------|-------------------------|
| TLC2274MJB | ACTIVE | CDIP | J | 14 | 1 | TBD | A42 | N / A for Pkg Type | -55 to 125 | 5962-9318201MC A TLC2274MJB | Samples |
| TLC2274MN | ACTIVE | PDIP | N | 14 | 25 | Pb-Free (RoHS) | CU NIPDAU | N / A for Pkg Type | -55 to 125 | TLC2274MN | Samples |
| TLC2274MWB | ACTIVE | CFP | W | 14 | 1 | TBD | A42 | N / A for Pkg Type | -55 to 125 | 5962-9318201QD A TLC2274MWB | Samples |
| TLC2274QD | ACTIVE | SOIC | D | 14 | 50 | Green (RoHS & no Sb/Br) | CU NIPDAU | Level-1-260C-UNLIM | -40 to 125 | TLC2274 | Samples |
| TLC2274QDG4 | ACTIVE | SOIC | D | 14 | 50 | Green (RoHS & no Sb/Br) | CU NIPDAU | Level-1-260C-UNLIM | | TLC2274 | Samples |
| TLC2274QDR | OBSOLETE | SOIC | D | 14 | | TBD | Call TI | Call TI | -40 to 125 | TLC2274 | |
| TLC2274QDRG4 | ACTIVE | SOIC | D | 14 | 2500 | Green (RoHS & no Sb/Br) | CU NIPDAU | Level-1-260C-UNLIM | | TLC2274 | Samples |
| TLC2274Y | PREVIEW | DIESALE | Y | 0 | | TBD | Call TI | Call TI | | | |

(1) The marketing status values are defined as follows:

ACTIVE: Product device recommended for new designs.

LIFEBUY: TI has announced that the device will be discontinued, and a lifetime-buy period is in effect.

NRND: Not recommended for new designs. Device is in production to support existing customers, but TI does not recommend using this part in a new design.

PREVIEW: Device has been announced but is not in production. Samples may or may not be available.

OBSOLETE: TI has discontinued the production of the device.

(2) Eco Plan - The planned eco-friendly classification: Pb-Free (RoHS), Pb-Free (RoHS Exempt), or Green (RoHS & no Sb/Br) - please check <http://www.ti.com/productcontent> for the latest availability information and additional product content details.

TBD: The Pb-Free/Green conversion plan has not been defined.

Pb-Free (RoHS): TI's terms "Lead-Free" or "Pb-Free" mean semiconductor products that are compatible with the current RoHS requirements for all 6 substances, including the requirement that lead not exceed 0.1% by weight in homogeneous materials. Where designed to be soldered at high temperatures, TI Pb-Free products are suitable for use in specified lead-free processes.

Pb-Free (RoHS Exempt): This component has a RoHS exemption for either 1) lead-based flip-chip solder bumps used between the die and package, or 2) lead-based die adhesive used between the die and leadframe. The component is otherwise considered Pb-Free (RoHS compatible) as defined above.

Green (RoHS & no Sb/Br): TI defines "Green" to mean Pb-Free (RoHS compatible), and free of Bromine (Br) and Antimony (Sb) based flame retardants (Br or Sb do not exceed 0.1% by weight in homogeneous material)

(3) MSL, Peak Temp. - The Moisture Sensitivity Level rating according to the JEDEC industry standard classifications, and peak solder temperature.

(4) There may be additional marking, which relates to the logo, the lot trace code information, or the environmental category on the device.

⁽⁵⁾ Multiple Device Markings will be inside parentheses. Only one Device Marking contained in parentheses and separated by a "--" will appear on a device. If a line is indented then it is a continuation of the previous line and the two combined represent the entire Device Marking for that device.

⁽⁶⁾ Lead/Ball Finish - Orderable Devices may have multiple material finish options. Finish options are separated by a vertical ruled line. Lead/Ball Finish values may wrap to two lines if the finish value exceeds the maximum column width.

Important Information and Disclaimer:The information provided on this page represents TI's knowledge and belief as of the date that it is provided. TI bases its knowledge and belief on information provided by third parties, and makes no representation or warranty as to the accuracy of such information. Efforts are underway to better integrate information from third parties. TI has taken and continues to take reasonable steps to provide representative and accurate information but may not have conducted destructive testing or chemical analysis on incoming materials and chemicals. TI and TI suppliers consider certain information to be proprietary, and thus CAS numbers and other limited information may not be available for release.

In no event shall TI's liability arising out of such information exceed the total purchase price of the TI part(s) at issue in this document sold by TI to Customer on an annual basis.

OTHER QUALIFIED VERSIONS OF TLC2272, TLC2272A, TLC2272AM, TLC2272M, TLC2274, TLC2274A, TLC2274AM, TLC2274M :

- Catalog: [TLC2272A](#), [TLC2272](#), [TLC2274A](#), [TLC2274](#)
- Automotive: [TLC2272-Q1](#), [TLC2272A-Q1](#), [TLC2272A-Q1](#), [TLC2272-Q1](#), [TLC2274-Q1](#), [TLC2274A-Q1](#), [TLC2274A-Q1](#), [TLC2274-Q1](#)
- Enhanced Product: [TLC2272A-EP](#), [TLC2272A-EP](#), [TLC2274-EP](#), [TLC2274A-EP](#), [TLC2274A-EP](#), [TLC2274-EP](#)
- Military: [TLC2272M](#), [TLC2272AM](#), [TLC2274M](#), [TLC2274AM](#)

NOTE: Qualified Version Definitions:

- Catalog - TI's standard catalog product
- Automotive - Q100 devices qualified for high-reliability automotive applications targeting zero defects
- Enhanced Product - Supports Defense, Aerospace and Medical Applications
- Military - QML certified for Military and Defense Applications

TAPE AND REEL INFORMATION



QUADRANT ASSIGNMENTS FOR PIN 1 ORIENTATION IN TAPE



*All dimensions are nominal

| Device | Package Type | Package Drawing | Pins | SPQ | Reel Diameter (mm) | Reel Width W1 (mm) | A0 (mm) | B0 (mm) | K0 (mm) | P1 (mm) | W (mm) | Pin1 Quadrant |
|------------------|--------------|-----------------|------|------|--------------------|--------------------|---------|---------|---------|---------|--------|---------------|
| 5962-9555201NXDR | SOIC | D | 8 | 2500 | 330.0 | 12.4 | 6.4 | 5.2 | 2.1 | 8.0 | 12.0 | Q1 |
| TLC2272ACDR | SOIC | D | 8 | 2500 | 330.0 | 12.4 | 6.4 | 5.2 | 2.1 | 8.0 | 12.0 | Q1 |
| TLC2272ACPWR | TSSOP | PW | 8 | 2000 | 330.0 | 12.4 | 7.0 | 3.6 | 1.6 | 8.0 | 12.0 | Q1 |
| TLC2272AIDR | SOIC | D | 8 | 2500 | 330.0 | 12.4 | 6.4 | 5.2 | 2.1 | 8.0 | 12.0 | Q1 |
| TLC2272AMDR | SOIC | D | 8 | 2500 | 330.0 | 12.4 | 6.4 | 5.2 | 2.1 | 8.0 | 12.0 | Q1 |
| TLC2272AMDRG4 | SOIC | D | 8 | 2500 | 330.0 | 12.4 | 6.4 | 5.2 | 2.1 | 8.0 | 12.0 | Q1 |
| TLC2272CDR | SOIC | D | 8 | 2500 | 330.0 | 12.4 | 6.4 | 5.2 | 2.1 | 8.0 | 12.0 | Q1 |
| TLC2272CPWR | TSSOP | PW | 8 | 2000 | 330.0 | 12.4 | 7.0 | 3.6 | 1.6 | 8.0 | 12.0 | Q1 |
| TLC2272IDR | SOIC | D | 8 | 2500 | 330.0 | 12.4 | 6.4 | 5.2 | 2.1 | 8.0 | 12.0 | Q1 |
| TLC2272IPWR | TSSOP | PW | 8 | 2000 | 330.0 | 12.4 | 7.0 | 3.6 | 1.6 | 8.0 | 12.0 | Q1 |
| TLC2272MDR | SOIC | D | 8 | 2500 | 330.0 | 12.4 | 6.4 | 5.2 | 2.1 | 8.0 | 12.0 | Q1 |
| TLC2274ACDR | SOIC | D | 14 | 2500 | 330.0 | 16.4 | 6.5 | 9.0 | 2.1 | 8.0 | 16.0 | Q1 |
| TLC2274ACPWR | TSSOP | PW | 14 | 2000 | 330.0 | 12.4 | 6.9 | 5.6 | 1.6 | 8.0 | 12.0 | Q1 |
| TLC2274AIDR | SOIC | D | 14 | 2500 | 330.0 | 16.4 | 6.5 | 9.0 | 2.1 | 8.0 | 16.0 | Q1 |
| TLC2274AIPWR | TSSOP | PW | 14 | 2000 | 330.0 | 12.4 | 6.9 | 5.6 | 1.6 | 8.0 | 12.0 | Q1 |
| TLC2274AQDR | SOIC | D | 14 | 2500 | 330.0 | 16.4 | 6.5 | 9.0 | 2.1 | 8.0 | 16.0 | Q1 |
| TLC2274CDR | SOIC | D | 14 | 2500 | 330.0 | 16.4 | 6.5 | 9.0 | 2.1 | 8.0 | 16.0 | Q1 |
| TLC2274CNSR | SO | NS | 14 | 2000 | 330.0 | 16.4 | 8.2 | 10.5 | 2.5 | 12.0 | 16.0 | Q1 |

| Device | Package Type | Package Drawing | Pins | SPQ | Reel Diameter (mm) | Reel Width W1 (mm) | A0 (mm) | B0 (mm) | K0 (mm) | P1 (mm) | W (mm) | Pin1 Quadrant |
|--------------|--------------|-----------------|------|------|--------------------|--------------------|---------|---------|---------|---------|--------|---------------|
| TLC2274CPWR | TSSOP | PW | 14 | 2000 | 330.0 | 12.4 | 6.9 | 5.6 | 1.6 | 8.0 | 12.0 | Q1 |
| TLC2274IDR | SOIC | D | 14 | 2500 | 330.0 | 16.4 | 6.5 | 9.0 | 2.1 | 8.0 | 16.0 | Q1 |
| TLC2274IPWR | TSSOP | PW | 14 | 2000 | 330.0 | 12.4 | 6.9 | 5.6 | 1.6 | 8.0 | 12.0 | Q1 |
| TLC2274MDR | SOIC | D | 14 | 2500 | 330.0 | 16.4 | 6.5 | 9.0 | 2.1 | 8.0 | 16.0 | Q1 |
| TLC2274MDRG4 | SOIC | D | 14 | 2500 | 330.0 | 16.4 | 6.5 | 9.0 | 2.1 | 8.0 | 16.0 | Q1 |
| TLC2274QDRG4 | SOIC | D | 14 | 2500 | 330.0 | 16.4 | 6.5 | 9.0 | 2.1 | 8.0 | 16.0 | Q1 |

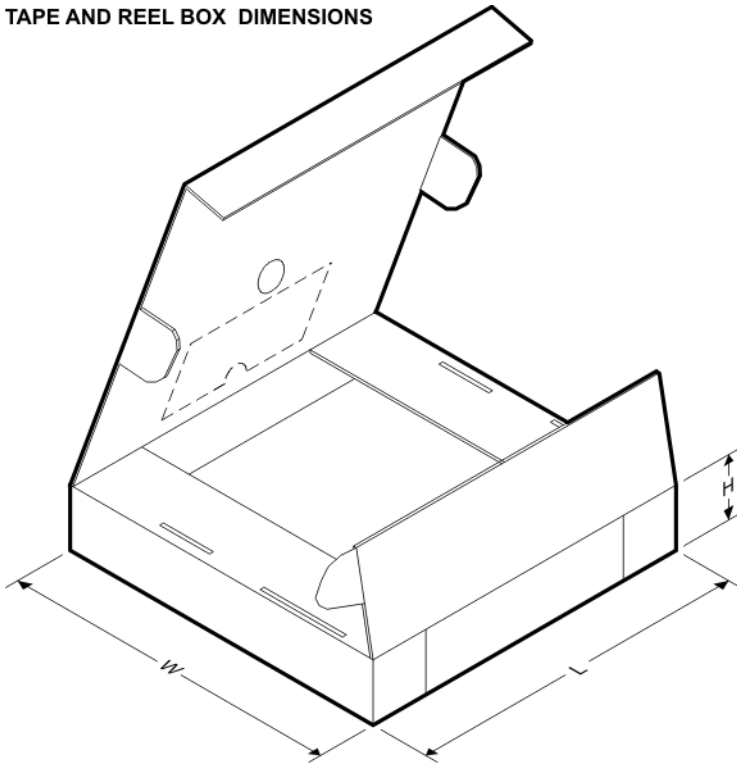
TAPE AND REEL BOX DIMENSIONS

*All dimensions are nominal

| Device | Package Type | Package Drawing | Pins | SPQ | Length (mm) | Width (mm) | Height (mm) |
|------------------|--------------|-----------------|------|------|-------------|------------|-------------|
| 5962-9555201NXDR | SOIC | D | 8 | 2500 | 367.0 | 367.0 | 35.0 |
| TLC2272ACDR | SOIC | D | 8 | 2500 | 340.5 | 338.1 | 20.6 |
| TLC2272ACPWR | TSSOP | PW | 8 | 2000 | 367.0 | 367.0 | 35.0 |
| TLC2272AIDR | SOIC | D | 8 | 2500 | 340.5 | 338.1 | 20.6 |
| TLC2272AMDR | SOIC | D | 8 | 2500 | 367.0 | 367.0 | 35.0 |
| TLC2272AMDRG4 | SOIC | D | 8 | 2500 | 367.0 | 367.0 | 35.0 |
| TLC2272CDR | SOIC | D | 8 | 2500 | 340.5 | 338.1 | 20.6 |
| TLC2272CPWR | TSSOP | PW | 8 | 2000 | 367.0 | 367.0 | 35.0 |
| TLC2272IDR | SOIC | D | 8 | 2500 | 340.5 | 338.1 | 20.6 |
| TLC2272IPWR | TSSOP | PW | 8 | 2000 | 367.0 | 367.0 | 35.0 |
| TLC2272MDR | SOIC | D | 8 | 2500 | 367.0 | 367.0 | 35.0 |

| Device | Package Type | Package Drawing | Pins | SPQ | Length (mm) | Width (mm) | Height (mm) |
|--------------|--------------|-----------------|------|------|-------------|------------|-------------|
| TLC2274ACDR | SOIC | D | 14 | 2500 | 333.2 | 345.9 | 28.6 |
| TLC2274ACPWR | TSSOP | PW | 14 | 2000 | 367.0 | 367.0 | 35.0 |
| TLC2274AIDR | SOIC | D | 14 | 2500 | 333.2 | 345.9 | 28.6 |
| TLC2274AIPWR | TSSOP | PW | 14 | 2000 | 367.0 | 367.0 | 35.0 |
| TLC2274AQDR | SOIC | D | 14 | 2500 | 367.0 | 367.0 | 38.0 |
| TLC2274CDR | SOIC | D | 14 | 2500 | 333.2 | 345.9 | 28.6 |
| TLC2274CNSR | SO | NS | 14 | 2000 | 367.0 | 367.0 | 38.0 |
| TLC2274CPWR | TSSOP | PW | 14 | 2000 | 367.0 | 367.0 | 35.0 |
| TLC2274IDR | SOIC | D | 14 | 2500 | 333.2 | 345.9 | 28.6 |
| TLC2274IPWR | TSSOP | PW | 14 | 2000 | 367.0 | 367.0 | 35.0 |
| TLC2274MDR | SOIC | D | 14 | 2500 | 367.0 | 367.0 | 38.0 |
| TLC2274MDRG4 | SOIC | D | 14 | 2500 | 367.0 | 367.0 | 38.0 |
| TLC2274QDRG4 | SOIC | D | 14 | 2500 | 367.0 | 367.0 | 38.0 |

JG (R-GDIP-T8)

CERAMIC DUAL-IN-LINE



- NOTES: A. All linear dimensions are in inches (millimeters).
 B. This drawing is subject to change without notice.
 C. This package can be hermetically sealed with a ceramic lid using glass frit.
 D. Index point is provided on cap for terminal identification.
 E. Falls within MIL STD 1835 GDIP1-T8

J (R-GDIP-T**)

14 LEADS SHOWN

CERAMIC DUAL IN-LINE PACKAGE



| DIM \ PINS ** | 14 | 16 | 18 | 20 |
|---------------|------------------------|------------------------|------------------------|------------------------|
| A | 0.300 (7,62) BSC | 0.300 (7,62) BSC | 0.300 (7,62) BSC | 0.300 (7,62) BSC |
| B MAX | 0.785 (19,94) | .840 (21,34) | 0.960 (24,38) | 1.060 (26,92) |
| B MIN | — | — | — | — |
| C MAX | 0.300 (7,62) | 0.300 (7,62) | 0.310 (7,87) | 0.300 (7,62) |
| C MIN | 0.245 (6,22) | 0.245 (6,22) | 0.220 (5,59) | 0.245 (6,22) |



4040083/F 03/03

- NOTES:
- All linear dimensions are in inches (millimeters).
 - This drawing is subject to change without notice.
 - This package is hermetically sealed with a ceramic lid using glass frit.
 - Index point is provided on cap for terminal identification only on press ceramic glass frit seal only.
 - Falls within MIL STD 1835 GDIP1-T14, GDIP1-T16, GDIP1-T18 and GDIP1-T20.

U (S-GDFP-F10)

CERAMIC DUAL FLATPACK

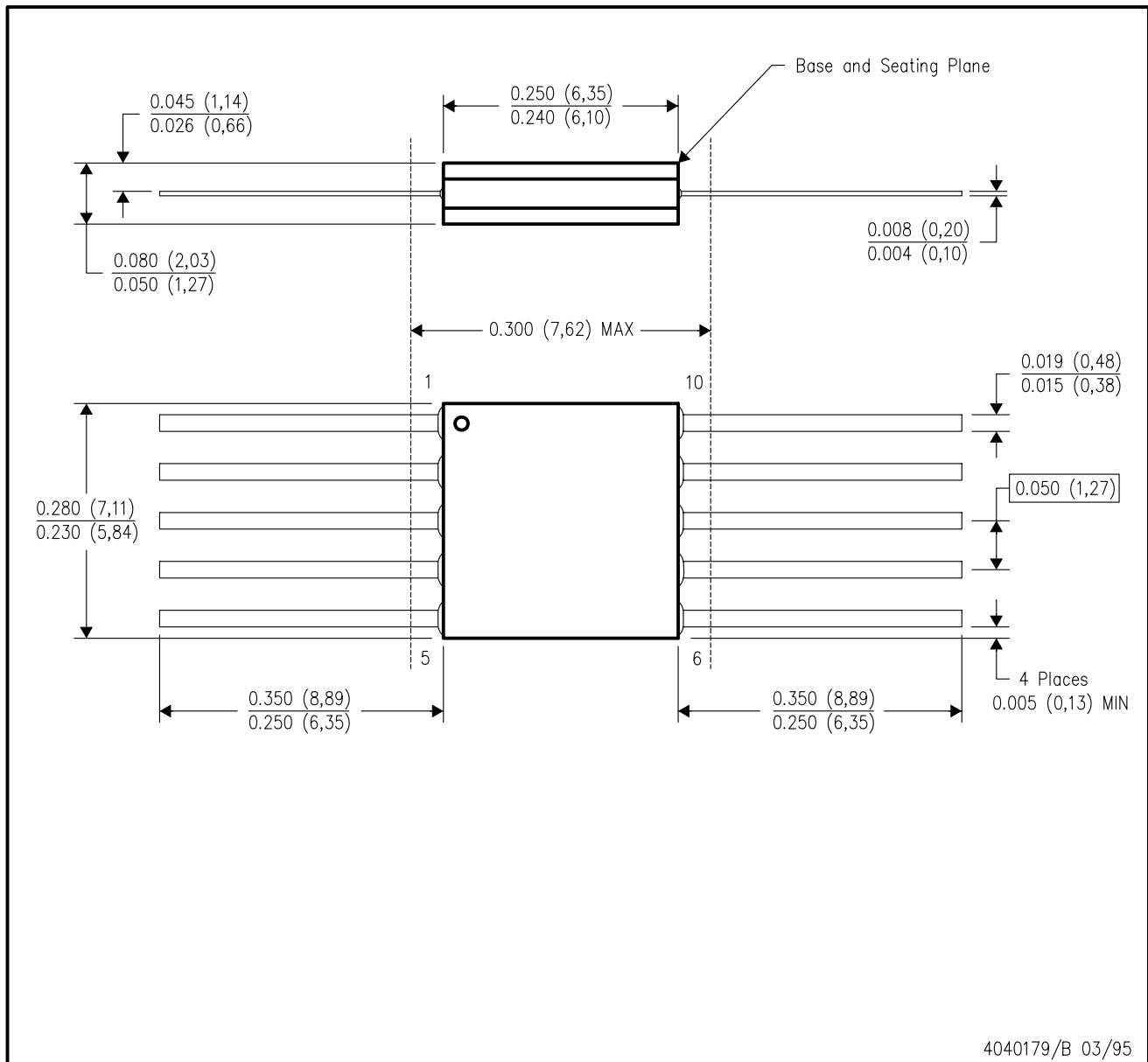

4040179/B 03/95

- NOTES:
- A. All linear dimensions are in inches (millimeters).
 - B. This drawing is subject to change without notice.
 - C. This package can be hermetically sealed with a ceramic lid using glass frit.
 - D. Index point is provided on cap for terminal identification only.
 - E. Falls within MIL STD 1835 GDFP1-F10 and JEDEC MO-092AA

W (R-GDFP-F14)

CERAMIC DUAL FLATPACK



- NOTES:
- A. All linear dimensions are in inches (millimeters).
 - B. This drawing is subject to change without notice.
 - C. This package can be hermetically sealed with a ceramic lid using glass frit.
 - D. Index point is provided on cap for terminal identification only.
 - E. Falls within MIL STD 1835 GDFP1-F14

FK (S-CQCC-N**)

LEADLESS CERAMIC CHIP CARRIER

28 TERMINAL SHOWN



| NO. OF TERMINALS ** | A | | B | |
|---------------------|------------------|------------------|------------------|------------------|
| | MIN | MAX | MIN | MAX |
| 20 | 0.342 (8,69) | 0.358 (9,09) | 0.307 (7,80) | 0.358 (9,09) |
| 28 | 0.442 (11,23) | 0.458 (11,63) | 0.406 (10,31) | 0.458 (11,63) |
| 44 | 0.640 (16,26) | 0.660 (16,76) | 0.495 (12,58) | 0.560 (14,22) |
| 52 | 0.740 (18,78) | 0.761 (19,32) | 0.495 (12,58) | 0.560 (14,22) |
| 68 | 0.938 (23,83) | 0.962 (24,43) | 0.850 (21,6) | 0.858 (21,8) |
| 84 | 1.141 (28,99) | 1.165 (29,59) | 1.047 (26,6) | 1.063 (27,0) |



4040140/D 01/11

- NOTES:
- All linear dimensions are in inches (millimeters).
 - This drawing is subject to change without notice.
 - This package can be hermetically sealed with a metal lid.
 - Falls within JEDEC MS-004

P (R-PDIP-T8)

PLASTIC DUAL-IN-LINE PACKAGE



4040082/E 04/2010

- NOTES:
- A. All linear dimensions are in inches (millimeters).
 - B. This drawing is subject to change without notice.
 - C. Falls within JEDEC MS-001 variation BA.

D (R-PDSO-G14)

PLASTIC SMALL OUTLINE

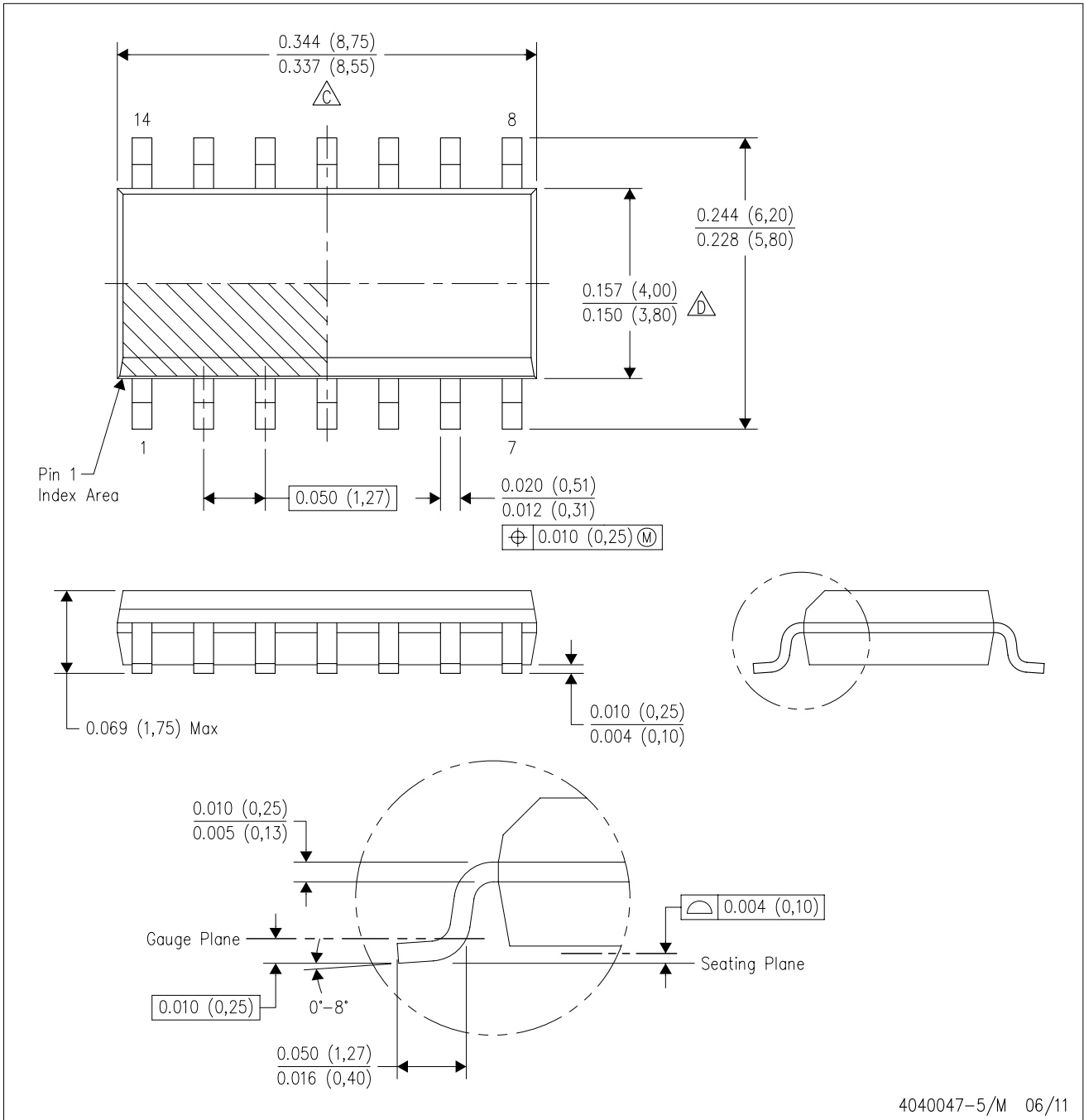

- NOTES:
- A. All linear dimensions are in inches (millimeters).
 - B. This drawing is subject to change without notice.
 - C. Body length does not include mold flash, protrusions, or gate burrs. Mold flash, protrusions, or gate burrs shall not exceed 0.006 (0,15) each side.
 - D. Body width does not include interlead flash. Interlead flash shall not exceed 0.017 (0,43) each side.
 - E. Reference JEDEC MS-012 variation AB.

D (R-PDSO-G14)

PLASTIC SMALL OUTLINE



- NOTES:
- All linear dimensions are in millimeters.
 - This drawing is subject to change without notice.
 - Publication IPC-7351 is recommended for alternate designs.
 - Laser cutting apertures with trapezoidal walls and also rounding corners will offer better paste release. Customers should contact their board assembly site for stencil design recommendations. Refer to IPC-7525 for other stencil recommendations.
 - Customers should contact their board fabrication site for solder mask tolerances between and around signal pads.

PW (R-PDSO-G14)

PLASTIC SMALL OUTLINE



4040064-3/G 02/11

- NOTES:
- A. All linear dimensions are in millimeters. Dimensioning and tolerancing per ASME Y14.5M-1994.
 - B. This drawing is subject to change without notice.
 -  Body length does not include mold flash, protrusions, or gate burrs. Mold flash, protrusions, or gate burrs shall not exceed 0,15 each side.
 -  Body width does not include interlead flash. Interlead flash shall not exceed 0,25 each side.
 - E. Falls within JEDEC MO-153

PW (R-PDSO-G14)

PLASTIC SMALL OUTLINE



4211284-2/G 08/15

- NOTES:
- A. All linear dimensions are in millimeters.
 - B. This drawing is subject to change without notice.
 - C. Publication IPC-7351 is recommended for alternate designs.
 - D. Laser cutting apertures with trapezoidal walls and also rounding corners will offer better paste release. Customers should contact their board assembly site for stencil design recommendations. Refer to IPC-7525 for other stencil recommendations.
 - E. Customers should contact their board fabrication site for solder mask tolerances between and around signal pads.

PW0008A



PACKAGE OUTLINE

TSSOP - 1.2 mm max height

SMALL OUTLINE PACKAGE



4221848/A 02/2015

NOTES:

1. All linear dimensions are in millimeters. Any dimensions in parenthesis are for reference only. Dimensioning and tolerancing per ASME Y14.5M.
2. This drawing is subject to change without notice.
3. This dimension does not include mold flash, protrusions, or gate burrs. Mold flash, protrusions, or gate burrs shall not exceed 0.15 mm per side.
4. This dimension does not include interlead flash. Interlead flash shall not exceed 0.25 mm per side.
5. Reference JEDEC registration MO-153, variation AA.

EXAMPLE BOARD LAYOUT

PW0008A

TSSOP - 1.2 mm max height

SMALL OUTLINE PACKAGE



LAND PATTERN EXAMPLE
SCALE:10X



SOLDER MASK DETAILS
NOT TO SCALE

4221848/A 02/2015

NOTES: (continued)

- 6. Publication IPC-7351 may have alternate designs.
- 7. Solder mask tolerances between and around signal pads can vary based on board fabrication site.

EXAMPLE STENCIL DESIGN

PW0008A

TSSOP - 1.2 mm max height

SMALL OUTLINE PACKAGE



SOLDER PASTE EXAMPLE
BASED ON 0.125 mm THICK STENCIL
SCALE:10X

4221848/A 02/2015

NOTES: (continued)

8. Laser cutting apertures with trapezoidal walls and rounded corners may offer better paste release. IPC-7525 may have alternate design recommendations.
9. Board assembly site may have different recommendations for stencil design.

D (R-PDSO-G8)

PLASTIC SMALL OUTLINE



NOTES: A. All linear dimensions are in inches (millimeters).
 B. This drawing is subject to change without notice.
 C. Body length does not include mold flash, protrusions, or gate burrs. Mold flash, protrusions, or gate burrs shall not exceed 0.006 (0,15) each side.
 D. Body width does not include interlead flash. Interlead flash shall not exceed 0.017 (0,43) each side.
 E. Reference JEDEC MS-012 variation AA.

D (R-PDSO-G8)

PLASTIC SMALL OUTLINE



- NOTES:
- All linear dimensions are in millimeters.
 - This drawing is subject to change without notice.
 - Publication IPC-7351 is recommended for alternate designs.
 - Laser cutting apertures with trapezoidal walls and also rounding corners will offer better paste release. Customers should contact their board assembly site for stencil design recommendations. Refer to IPC-7525 for other stencil recommendations.
 - Customers should contact their board fabrication site for solder mask tolerances between and around signal pads.

MECHANICAL DATA

PS (R-PDSO-G8)

PLASTIC SMALL-OUTLINE PACKAGE



- NOTES:
- A. All linear dimensions are in millimeters.
 - B. This drawing is subject to change without notice.
 - C. Body dimensions do not include mold flash or protrusion, not to exceed 0,15.

PS (R-PDSO-G8)

PLASTIC SMALL OUTLINE

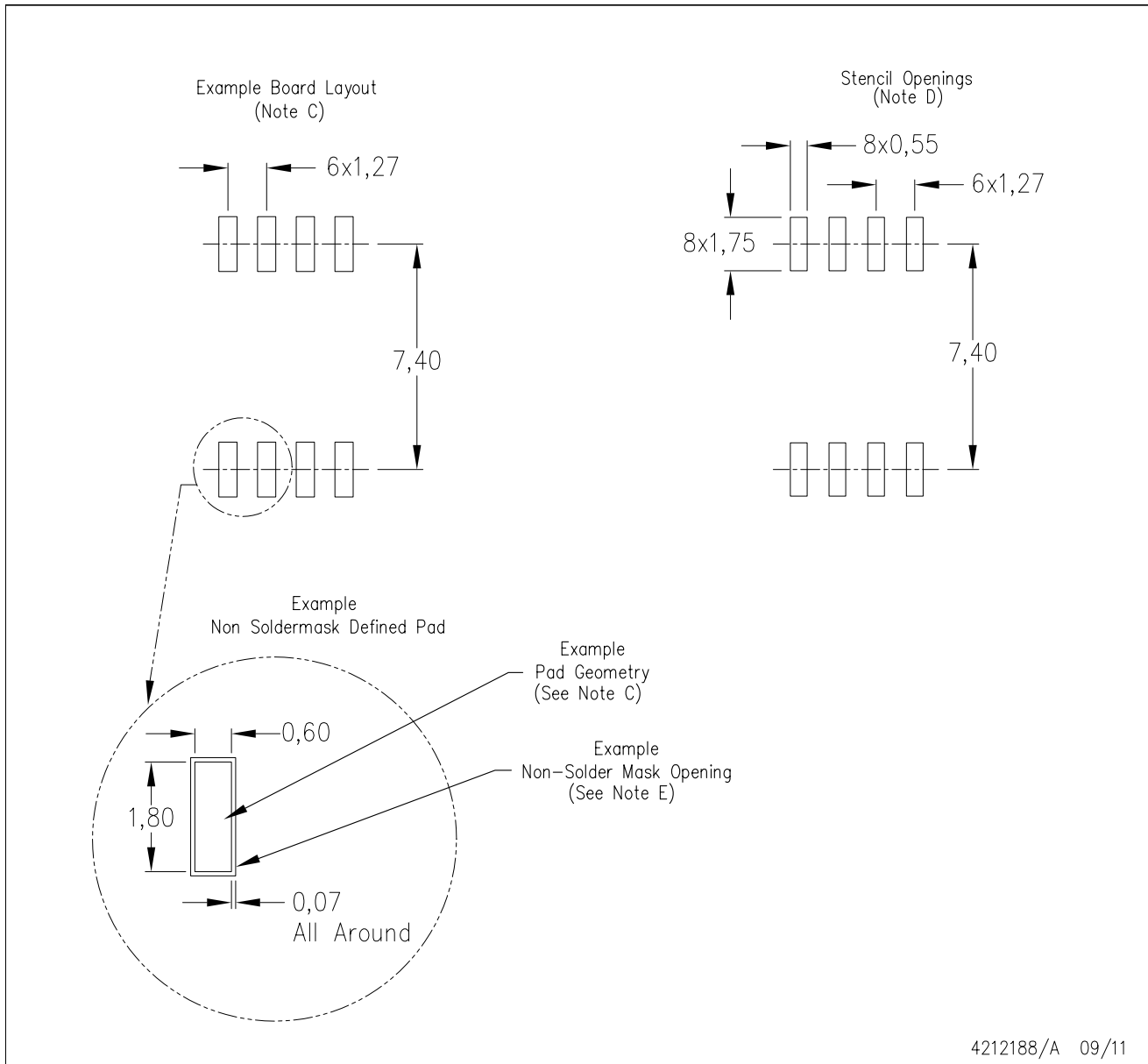

- NOTES:
- All linear dimensions are in millimeters.
 - This drawing is subject to change without notice.
 - Publication IPC-7351 is recommended for alternate designs.
 - Laser cutting apertures with trapezoidal walls and also rounding corners will offer better paste release. Customers should contact their board assembly site for stencil design recommendations. Refer to IPC-7525 for other stencil recommendations.
 - Customers should contact their board fabrication site for solder mask tolerances between and around signal pads.

MECHANICAL DATA

NS (R-PDSO-G**)

PLASTIC SMALL-OUTLINE PACKAGE

14-PINS SHOWN



- NOTES:
- A. All linear dimensions are in millimeters.
 - B. This drawing is subject to change without notice.
 - C. Body dimensions do not include mold flash or protrusion, not to exceed 0,15.

IMPORTANT NOTICE

Texas Instruments Incorporated and its subsidiaries (TI) reserve the right to make corrections, enhancements, improvements and other changes to its semiconductor products and services per JESD46, latest issue, and to discontinue any product or service per JESD48, latest issue. Buyers should obtain the latest relevant information before placing orders and should verify that such information is current and complete. All semiconductor products (also referred to herein as "components") are sold subject to TI's terms and conditions of sale supplied at the time of order acknowledgment.

TI warrants performance of its components to the specifications applicable at the time of sale, in accordance with the warranty in TI's terms and conditions of sale of semiconductor products. Testing and other quality control techniques are used to the extent TI deems necessary to support this warranty. Except where mandated by applicable law, testing of all parameters of each component is not necessarily performed.

TI assumes no liability for applications assistance or the design of Buyers' products. Buyers are responsible for their products and applications using TI components. To minimize the risks associated with Buyers' products and applications, Buyers should provide adequate design and operating safeguards.

TI does not warrant or represent that any license, either express or implied, is granted under any patent right, copyright, mask work right, or other intellectual property right relating to any combination, machine, or process in which TI components or services are used. Information published by TI regarding third-party products or services does not constitute a license to use such products or services or a warranty or endorsement thereof. Use of such information may require a license from a third party under the patents or other intellectual property of the third party, or a license from TI under the patents or other intellectual property of TI.

Reproduction of significant portions of TI information in TI data books or data sheets is permissible only if reproduction is without alteration and is accompanied by all associated warranties, conditions, limitations, and notices. TI is not responsible or liable for such altered documentation. Information of third parties may be subject to additional restrictions.

Resale of TI components or services with statements different from or beyond the parameters stated by TI for that component or service voids all express and any implied warranties for the associated TI component or service and is an unfair and deceptive business practice. TI is not responsible or liable for any such statements.

Buyer acknowledges and agrees that it is solely responsible for compliance with all legal, regulatory and safety-related requirements concerning its products, and any use of TI components in its applications, notwithstanding any applications-related information or support that may be provided by TI. Buyer represents and agrees that it has all the necessary expertise to create and implement safeguards which anticipate dangerous consequences of failures, monitor failures and their consequences, lessen the likelihood of failures that might cause harm and take appropriate remedial actions. Buyer will fully indemnify TI and its representatives against any damages arising out of the use of any TI components in safety-critical applications.

In some cases, TI components may be promoted specifically to facilitate safety-related applications. With such components, TI's goal is to help enable customers to design and create their own end-product solutions that meet applicable functional safety standards and requirements. Nonetheless, such components are subject to these terms.

No TI components are authorized for use in FDA Class III (or similar life-critical medical equipment) unless authorized officers of the parties have executed a special agreement specifically governing such use.

Only those TI components which TI has specifically designated as military grade or "enhanced plastic" are designed and intended for use in military/aerospace applications or environments. Buyer acknowledges and agrees that any military or aerospace use of TI components which have **not** been so designated is solely at the Buyer's risk, and that Buyer is solely responsible for compliance with all legal and regulatory requirements in connection with such use.

TI has specifically designated certain components as meeting ISO/TS16949 requirements, mainly for automotive use. In any case of use of non-designated products, TI will not be responsible for any failure to meet ISO/TS16949.

Products

| | |
|------------------------------|--------------------------------------------------------------------------------------|
| Audio | www.ti.com/audio |
| Amplifiers | amplifier.ti.com |
| Data Converters | dataconverter.ti.com |
| DLP® Products | www.dlp.com |
| DSP | dsp.ti.com |
| Clocks and Timers | www.ti.com/clocks |
| Interface | interface.ti.com |
| Logic | logic.ti.com |
| Power Mgmt | power.ti.com |
| Microcontrollers | microcontroller.ti.com |
| RFID | www.ti-rfid.com |
| OMAP Applications Processors | www.ti.com/omap |
| Wireless Connectivity | www.ti.com/wirelessconnectivity |

Applications

| | |
|-------------------------------|------------------------------------------------------------------------------------------|
| Automotive and Transportation | www.ti.com/automotive |
| Communications and Telecom | www.ti.com/communications |
| Computers and Peripherals | www.ti.com/computers |
| Consumer Electronics | www.ti.com/consumer-apps |
| Energy and Lighting | www.ti.com/energy |
| Industrial | www.ti.com/industrial |
| Medical | www.ti.com/medical |
| Security | www.ti.com/security |
| Space, Avionics and Defense | www.ti.com/space-avionics-defense |
| Video and Imaging | www.ti.com/video |

TI E2E Community

e2e.ti.com

AMEYA360

Components Supply Platform

Authorized Distribution Brand :



Website :

Welcome to visit www.ameya360.com

Contact Us :

➤ Address :

401 Building No.5, JiuGe Business Center, Lane 2301, Yishan Rd
Minhang District, Shanghai , China

➤ Sales :

Direct +86 (21) 6401-6692

Email amall@ameya360.com

QQ 800077892

Skype [ameyasales1](#) [ameyasales2](#)

➤ Customer Service :

Email service@ameya360.com

➤ Partnership :

Tel +86 (21) 64016692-8333

Email mkt@ameya360.com