

# TLE2426, TLE2426Y THE "RAIL SPLITTER" PRECISION VIRTUAL GROUND

SLOS098D – AUGUST 1991 – REVISED MAY 1998

- 1/2  $V_I$  Virtual Ground for Analog Systems
- Self-Contained 3-terminal TO-226AA Package
- Micropower Operation . . . 170  $\mu\text{A}$  Typ,  $V_I = 5\text{ V}$
- Wide  $V_I$  Range . . . 4 V to 40 V
- High Output-Current Capability
  - Source . . . 20 mA Typ
  - Sink . . . 20 mA Typ

- Excellent Output Regulation
  - $-45\ \mu\text{V}$  Typ at  $I_O = 0$  to  $-10\ \text{mA}$
  - $+15\ \mu\text{V}$  Typ at  $I_O = 0$  to  $+10\ \text{mA}$
- Low-Impedance Output . . .  $0.0075\ \Omega$  Typ
- Noise Reduction Pin (D, JG, and P Packages Only)

## description

In signal-conditioning applications utilizing a single power source, a reference voltage equal to one-half the supply voltage is required for termination of all analog signal grounds. Texas Instruments presents a precision virtual ground whose output voltage is always equal to one-half the input voltage, the TLE2426 "rail splitter."

The unique combination of a high-performance, micropower operational amplifier and a precision-trimmed divider on a single silicon chip results in a precise  $V_O/V_I$  ratio of 0.5 while sinking and sourcing current. The TLE2426 provides a low-impedance output with 20 mA of sink and source capability while drawing less than 280  $\mu\text{A}$  of supply current over the full input range of 4 V to 40 V. A designer need not pay the price in terms of board space for a conventional signal ground consisting of resistors, capacitors, operational amplifiers, and voltage references. The performance and precision of the TLE2426 is available in an easy-to-use, space saving, 3-terminal LP package. For increased performance, the optional 8-pin packages provide a noise-reduction pin. With the addition of an external capacitor ( $C_{NR}$ ), peak-to-peak noise is reduced while line ripple rejection is improved.

Initial output tolerance for a single 5-V or 12-V system is better than 1% with 3.6% over the full 40-V input range. Ripple rejection exceeds 12 bits of accuracy. Whether the application is for a data acquisition front end, analog signal termination, or simply a precision voltage reference, the TLE2426 eliminates a major source of system error.

INPUT/OUTPUT TRANSFER CHARACTERISTICS

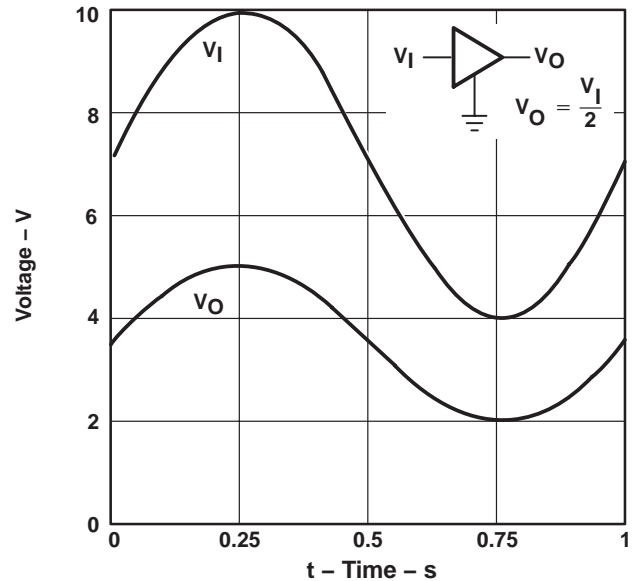

## AVAILABLE OPTIONS

PACKAGED DEVICES					CHIP FORM (Y)
$T_A$	SMALL OUTLINE (D)	CERAMIC DIP (JG)	PLASTIC (LP)	PLASTIC DIP (P)	
0°C to 70°C	TLE2426CD	—	TLE2426CLP	TLE2426CP	



Please be aware that an important notice concerning availability, standard warranty, and use in critical applications of Texas Instruments semiconductor products and disclaimers thereto appears at the end of this data sheet.

PRODUCTION DATA information is current as of publication date. Products conform to specifications per the terms of Texas Instruments standard warranty. Production processing does not necessarily include testing of all parameters.

**TEXAS  
INSTRUMENTS**

POST OFFICE BOX 655303 • DALLAS, TEXAS 75265

Copyright © 1998, Texas Instruments Incorporated

# TLE2426, TLE2426Y THE "RAIL SPLITTER" PRECISION VIRTUAL GROUND

SLOS098D – AUGUST 1991 – REVISED MAY 1998

---

-40°C to 85°C	TLE2426ID	—	TLE2426ILP	TLE2426IP	TLE2426Y
-55°C to 125°C	TLE2426MD	TLE2426MJG	TLE2426MLP	TLE2426MP	

The D and LP packages are available taped and reeled in the commercial temperature range only. Add R suffix to the device type (e. g., TLC2426CDR). Chips are tested at 25°C.



POST OFFICE BOX 655303 • DALLAS, TEXAS 75265

**description (continued)**

The C-suffix devices are characterized for operation from 0°C to 70°C. The I suffix devices are characterized for operation from -40°C to 85°C. The M suffix devices are characterized over the full military temperature range of -55°C to 125°C.

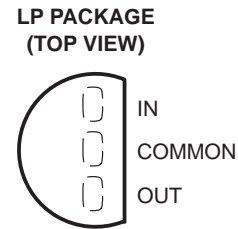
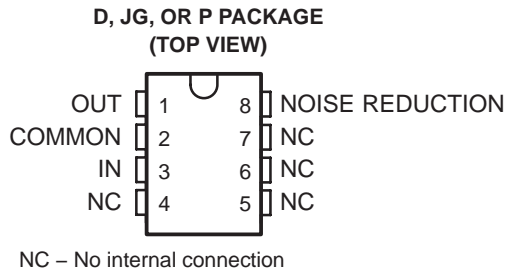

**TLE2426Y chip information**

This chip, properly assembled, displays characteristics similar to the TLE2426C. Thermal compression or ultrasonic bonding may be used on the doped aluminum bonding pads. The chips may be mounted with conductive epoxy or a gold-silicon preform.

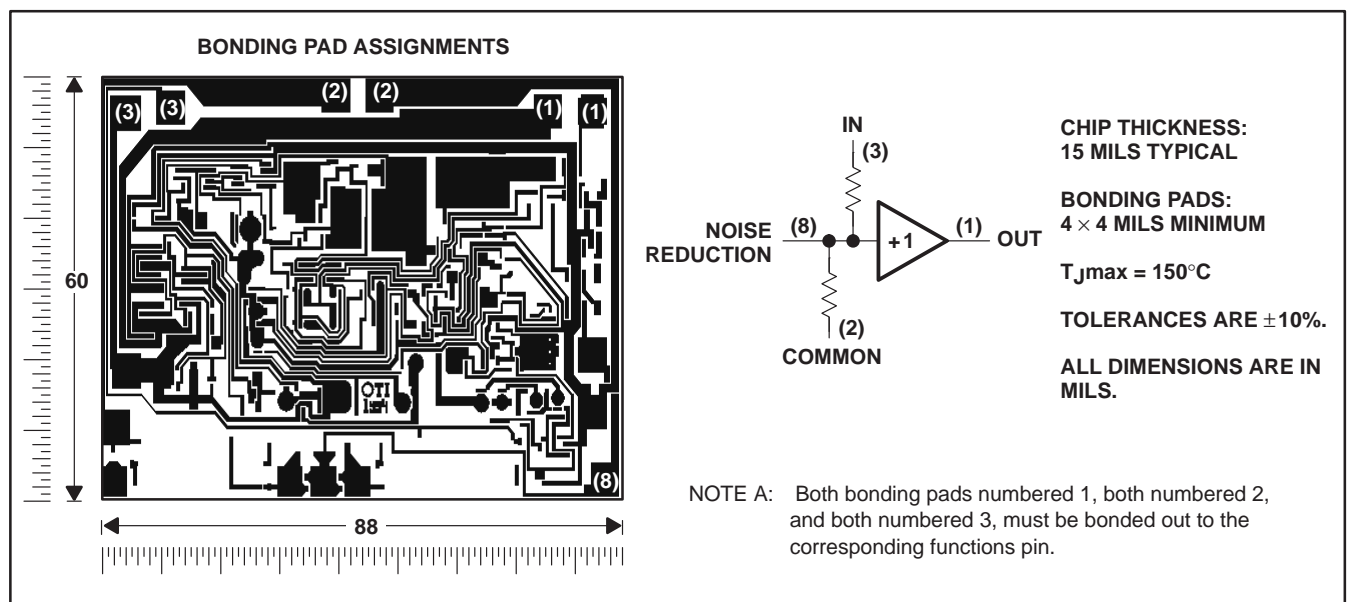



**electrical characteristics at specified free-air temperature,  $V_I = 5\text{ V}$ ,  $I_O = 0$  (unless otherwise noted)**

PARAMETER	TEST CONDITIONS		$T_A$ †	TLE2426C			UNIT
				MIN	TYP	MAX	
Output voltage	$V_I = 4\text{ V}$		25°C	1.98	2	2.02	V
	$V_I = 5\text{ V}$			2.48	2.5	2.52	
	$V_I = 40\text{ V}$			19.8	20	20.2	
	$V_I = 5\text{ V}$		Full range	2.475		2.525	
Temperature coefficient of output voltage			Full range	25		ppm/°C	
Supply current	No load	$V_I = 5\text{ V}$	25°C	170	300	µA	
		$V_I = 4\text{ to }40\text{ V}$	Full range	400			
Output voltage regulation (sourcing current)‡	$I_O = 0\text{ to }-10\text{ mA}$		25°C	-45	±160	µV	
			Full range	±250			
Output voltage regulation (sinking current)‡	$I_O = 0\text{ to }-20\text{ mA}$		25°C	-150	±450	µV	
			Full range	±250			
Output voltage regulation (sinking current)‡	$I_O = 0\text{ to }10\text{ mA}$		25°C	15	±160	µV	
			Full range	±250			
Output impedance			25°C	7.5	22.5	mΩ	
Noise-reduction impedance			25°C	110		kΩ	
Short-circuit current	Sinking current, $V_O = 5\text{ V}$		25°C	26		mA	
	Sourcing current, $V_O = 0$			-47			
Output noise voltage, rms	$f = 10\text{ Hz to }10\text{ kHz}$	$C_{NR} = 0$	25°C	120		µV	
		$C_{NR} = 1\text{ µF}$		30			
Output voltage current step response	$V_O\text{ to }0.1\%$ , $I_O = \pm 10\text{ mA}$	$C_L = 0$	25°C	290		µs	
		$C_L = 100\text{ pF}$		275			
	$V_O\text{ to }0.01\%$ , $I_O = \pm 10\text{ mA}$	$C_L = 0$	25°C	400			
		$C_L = 100\text{ pF}$		390			
Step response	$V_I = 0\text{ to }5\text{ V}$ , $V_O\text{ to }0.1\%$		25°C	20		µs	
	$V_I = 0\text{ to }5\text{ V}$ , $V_O\text{ to }0.01\%$			160			

† Full range is 0°C to 70°C.

‡ The listed values are not production tested.

**TLE2426, TLE2426Y**  
**THE “RAIL SPLITTER”**  
**PRECISION VIRTUAL GROUND**

SLOS098D – AUGUST 1991 – REVISED MAY 1998

electrical characteristics at specified free-air temperature,  $V_I = 12\text{ V}$ ,  $I_O = 0$  (unless otherwise noted)

PARAMETER	TEST CONDITIONS		$T_A$ †	TLE2426C			UNIT
				MIN	TYP	MAX	
Output voltage	$V_I = 4\text{ V}$		25°C	1.98	2	2.02	V
	$V_I = 12\text{ V}$			5.95	6	6.05	
	$V_I = 40\text{ V}$			19.8	20	20.2	
	$V_I = 12\text{ V}$		Full range	5.945		6.055	
Temperature coefficient of output voltage			Full range	35		ppm/°C	
Supply current	No load	$V_I = 12\text{ V}$	25°C	195	300	μA	
		$V_I = 4\text{ to }40\text{ V}$	Full range	400			
Output voltage regulation (sourcing current)‡	$I_O = 0\text{ to }-10\text{ mA}$		25°C	-45	±160	μV	
			Full range	±250			
Output voltage regulation (sinking current)‡	$I_O = 0\text{ to }-20\text{ mA}$		25°C	-150	±450	μV	
			Full range	±250			
Output voltage regulation (sinking current)‡	$I_O = 0\text{ to }10\text{ mA}$		25°C	15	±160	μV	
			Full range	±250			
Output impedance			25°C	7.5	22.5	mΩ	
Noise-reduction impedance			25°C	110		kΩ	
Short-circuit current	Sinking current, $V_O = 12\text{ V}$		25°C	31		mA	
	Sourcing current, $V_O = 0$			-70			
Output noise voltage, rms	$f = 10\text{ Hz to }10\text{ kHz}$	$C_{NR} = 0$	25°C	120		μV	
		$C_{NR} = 1\text{ μF}$		30			
Output voltage current step response	$V_O\text{ to }0.1\%$ , $I_O = \pm 10\text{ mA}$	$C_L = 0$	25°C	290		μs	
		$C_L = 100\text{ pF}$		275			
	$V_O\text{ to }0.01\%$ , $I_O = \pm 10\text{ mA}$	$C_L = 0$	25°C	400			
		$C_L = 100\text{ pF}$		390			
Step response	$V_I = 0\text{ to }12\text{ V}$ , $V_O\text{ to }0.1\%$		25°C	20		μs	
	$V_I = 0\text{ to }12\text{ V}$ , $V_O\text{ to }0.01\%$			120			

† Full range is 0°C to 70°C.

‡ The listed values are not production tested.



**electrical characteristics at specified free-air temperature,  $V_I = 5\text{ V}$ ,  $I_O = 0$  (unless otherwise noted)**

PARAMETER	TEST CONDITIONS		$T_A$ †	TLE2426I			UNIT
				MIN	TYP	MAX	
Output voltage	$V_I = 4\text{ V}$		25°C	1.98	2	2.02	V
	$V_I = 5\text{ V}$			2.48	2.5	2.52	
	$V_I = 40\text{ V}$			19.8	20	20.2	
	$V_I = 5\text{ V}$		Full range	2.47		2.53	
Temperature coefficient of output voltage			Full range	25		ppm/°C	
Supply current	No load	$V_I = 5\text{ V}$	25°C	170	300	μA	
		$V_I = 4\text{ to }40\text{ V}$	Full range	400			
Output voltage regulation (sourcing current)‡	$I_O = 0\text{ to }-10\text{ mA}$		25°C	-45	±160	μV	
			Full range	±250			
Output voltage regulation (sinking current)‡	$I_O = 0\text{ to }-20\text{ mA}$		25°C	-150	±450	μV	
			Full range	±250			
Output voltage regulation (sinking current)‡	$I_O = 0\text{ to }10\text{ mA}$		25°C	15	±160	μV	
	$I_O = 0\text{ to }8\text{ mA}$		Full range	±250			
	$I_O = 0\text{ to }20\text{ mA}$		25°C	65	±235		
Output impedance			25°C	7.5	22.5	mΩ	
Noise-reduction impedance			25°C	110		kΩ	
Short-circuit current	Sinking current,	$V_O = 5\text{ V}$	25°C	26		mA	
	Sourcing current,	$V_O = 0$		-47			
Output noise voltage, rms	$f = 10\text{ Hz to }10\text{ kHz}$	$C_{NR} = 0$	25°C	120		μV	
		$C_{NR} = 1\text{ μF}$		30			
Output voltage current step response	$V_O\text{ to }0.1\%$ , $I_O = \pm 10\text{ mA}$	$C_L = 0$	25°C	290		μs	
		$C_L = 100\text{ pF}$		275			
	$V_O\text{ to }0.01\%$ , $I_O = \pm 10\text{ mA}$	$C_L = 0$	25°C	400			
		$C_L = 100\text{ pF}$		390			
Step response	$V_I = 0\text{ to }5\text{ V}$ , $V_O\text{ to }0.1\%$		25°C	20		μs	
	$V_I = 0\text{ to }5\text{ V}$ , $V_O\text{ to }0.01\%$			160			

† Full range is -40°C to 85°C.

‡ The listed values are not production tested.

**TLE2426, TLE2426Y**  
**THE “RAIL SPLITTER”**  
**PRECISION VIRTUAL GROUND**

SLOS098D – AUGUST 1991 – REVISED MAY 1998

electrical characteristics at specified free-air temperature,  $V_I = 12\text{ V}$ ,  $I_O = 0$  (unless otherwise noted)

PARAMETER	TEST CONDITIONS		$T_A$ †	TLE2426I			UNIT
				MIN	TYP	MAX	
Output voltage	$V_I = 4\text{ V}$		25°C	1.98	2	2.02	V
	$V_I = 12\text{ V}$			5.95	6	6.05	
	$V_I = 40\text{ V}$			19.8	20	20.2	
	$V_I = 12\text{ V}$		Full range	5.935		6.065	
Temperature coefficient of output voltage			Full range	35		ppm/°C	
Supply current	No load	$V_I = 12\text{ V}$	25°C	195	300	µA	
		$V_I = 4\text{ to }40\text{ V}$	Full range	400			
Output voltage regulation (sourcing current)‡	$I_O = 0\text{ to }-10\text{ mA}$		25°C	-45	±160	µV	
			Full range	±250			
Output voltage regulation (sinking current)‡	$I_O = 0\text{ to }-20\text{ mA}$		25°C	-150	±450	µV	
			Full range	±250			
Output voltage regulation (sinking current)‡	$I_O = 0\text{ to }10\text{ mA}$		25°C	15	±160	µV	
	$I_O = 0\text{ to }8\text{ mA}$		Full range	±250			
	$I_O = 0\text{ to }20\text{ mA}$		25°C	65	±235		
Output impedance			25°C	7.5	22.5	mΩ	
Noise-reduction impedance			25°C	110		kΩ	
Short-circuit current	Sinking current, $V_O = 12\text{ V}$		25°C	31		mA	
	Sourcing current, $V_O = 0$			-70			
Output noise voltage, rms	$f = 10\text{ Hz to }10\text{ kHz}$	$C_{NR} = 0$	25°C	120		µV	
		$C_{NR} = 1\text{ µF}$		30			
Output voltage current step response	$V_O\text{ to }0.1\%$ , $I_O = \pm 10\text{ mA}$	$C_L = 0$	25°C	290		µs	
		$C_L = 100\text{ pF}$		275			
	$V_O\text{ to }0.01\%$ , $I_O = \pm 10\text{ mA}$	$C_L = 0$	25°C	400			
		$C_L = 100\text{ pF}$		390			
Step response	$V_I = 0\text{ to }12\text{ V}$ , $V_O\text{ to }0.1\%$		25°C	20		µs	
	$V_I = 0\text{ to }12\text{ V}$ , $V_O\text{ to }0.01\%$			120			

† Full range is -40°C to 85°C.

‡ The listed values are not production tested.





**electrical characteristics at specified free-air temperature,  $V_I = 5\text{ V}$ ,  $I_O = 0$  (unless otherwise noted)**

PARAMETER	TEST CONDITIONS		$T_A$ †	TLE2426M			UNIT
				MIN	TYP	MAX	
Output voltage	$V_I = 4\text{ V}$		25°C	1.98	2	2.02	V
	$V_I = 5\text{ V}$			2.48	2.5	2.52	
	$V_I = 40\text{ V}$			19.8	20	20.2	
	$V_I = 5\text{ V}$		Full range	2.465 2.535			
Temperature coefficient of output voltage			Full range	25		ppm/°C	
Supply current	No load	$V_I = 5\text{ V}$	25°C	170	300	µA	
		$V_I = 4\text{ to }40\text{ V}$	Full range	400			
Output voltage regulation (sourcing current)‡	$I_O = 0\text{ to }-10\text{ mA}$		25°C	-45	±160	µV	
			Full range	±250			
Output voltage regulation (sinking current)‡	$I_O = 0\text{ to }-20\text{ mA}$		25°C	-150	±450	µV	
			Full range	±250			
Output voltage regulation (sinking current)‡	$I_O = 0\text{ to }10\text{ mA}$		25°C	15	±160	µV	
	$I_O = 0\text{ to }3\text{ mA}$		Full range	±250			
	$I_O = 0\text{ to }20\text{ mA}$		25°C	65	±235		
Output impedance			25°C	7.5	22.5	mΩ	
Noise-reduction impedance			25°C	110		kΩ	
Short-circuit current	Sinking current, $V_O = 5\text{ V}$		25°C	26		mA	
	Sourcing current, $V_O = 0$			-47			
Output noise voltage, rms	$f = 10\text{ Hz to }10\text{ kHz}$	$C_{NR} = 0$	25°C	120		µV	
		$C_{NR} = 1\text{ µF}$		30			
Output voltage current step response	$V_O\text{ to }0.1\%$ , $I_O = \pm 10\text{ mA}$	$C_L = 0$	25°C	290		µs	
		$C_L = 100\text{ pF}$		275			
	$V_O\text{ to }0.01\%$ , $I_O = \pm 10\text{ mA}$	$C_L = 0$	25°C	400			
		$C_L = 100\text{ pF}$		390			
Step response	$V_I = 0\text{ to }5\text{ V}$ , $V_O\text{ to }0.1\%$		25°C	20		µs	
	$V_I = 0\text{ to }5\text{ V}$ , $V_O\text{ to }0.01\%$			120			

† Full range is -55°C to 125°C.

‡ The listed values are not production tested.

**TLE2426, TLE2426Y**  
**THE “RAIL SPLITTER”**  
**PRECISION VIRTUAL GROUND**

SLOS098D – AUGUST 1991 – REVISED MAY 1998

electrical characteristics at specified free-air temperature,  $V_I = 12\text{ V}$ ,  $I_O = 0$  (unless otherwise noted)

PARAMETER	TEST CONDITIONS		$T_A$ †	TLE2426M			UNIT
				MIN	TYP	MAX	
Output voltage	$V_I = 4\text{ V}$		25°C	1.98	2	2.02	V
	$V_I = 12\text{ V}$			5.95	6	6.05	
	$V_I = 40\text{ V}$			19.8	20	20.2	
	$V_I = 12\text{ V}$		Full range	5.925		6.075	
Temperature coefficient of output voltage			Full range	35		ppm/°C	
Supply current	No load	$V_I = 12\text{ V}$	25°C	195	250	μA	
		$V_I = 4\text{ to }40\text{ V}$	Full range	350			
Output voltage regulation (sourcing current)‡	$I_O = 0\text{ to }-10\text{ mA}$		25°C	-45	±160	μV	
			Full range	±250			
Output voltage regulation (sinking current)‡	$I_O = 0\text{ to }-20\text{ mA}$		25°C	-150	±450	μV	
			Full range	±250			
Output voltage regulation (sinking current)‡	$I_O = 0\text{ to }10\text{ mA}$		25°C	15	±160	μV	
	$I_O = 0\text{ to }8\text{ mA}$		Full range	±250			
	$I_O = 0\text{ to }20\text{ mA}$		25°C	65	±235		
Output impedance			25°C	7.5	22.5	mΩ	
Noise-reduction impedance			25°C	110		kΩ	
Short-circuit current	Sinking current, $V_O = 12\text{ V}$		25°C	31		mA	
	Sourcing current, $V_O = 0$			-70			
Output noise voltage, rms	$f = 10\text{ Hz to }10\text{ kHz}$	$C_{NR} = 0$	25°C	120		μV	
		$C_{NR} = 1\text{ μF}$		30			
Output voltage current step response	$V_O\text{ to }0.1\%$ , $I_O = \pm 10\text{ mA}$	$C_L = 0$	25°C	290		μs	
		$C_L = 100\text{ pF}$		275			
	$V_O\text{ to }0.01\%$ , $I_O = \pm 10\text{ mA}$	$C_L = 0$	25°C	400			
		$C_L = 100\text{ pF}$		390			
Step response	$V_I = 0\text{ to }12\text{ V}$ , $V_O\text{ to }0.1\%$		25°C	12		μs	
	$V_I = 0\text{ to }12\text{ V}$ , $V_O\text{ to }0.01\%$			120			

† Full range is -55°C to 125°C.

‡ The listed values are not production tested.



**electrical characteristics at specified free-air temperature,  $V_I = 5\text{ V}$ ,  $I_O = 0$ ,  $T_A = 25^\circ\text{C}$  (unless otherwise noted)**

PARAMETER	TEST CONDITIONS	TLE2426Y			UNIT
		MIN	TYP	MAX	
Output voltage	$V_I = 5\text{ V}$	2.5			V
Supply current	No load	170			$\mu\text{A}$
Output voltage regulation (sourcing current) <sup>†</sup>	$I_O = 0$ to $-10\text{ mA}$	-45			$\mu\text{V}$
	$I_O = 0$ to $-20\text{ mA}$	-150			
Output voltage regulation (sinking current) <sup>†</sup>	$I_O = 0$ to $10\text{ mA}$	15			$\mu\text{V}$
	$I_O = 0$ to $20\text{ mA}$	65			
Output impedance		7.5			$\text{m}\Omega$
Noise-reduction impedance		110			$\text{k}\Omega$
Short-circuit current	Sinking current, $V_O = 5\text{ V}$	26			mA
	Sourcing current, $V_O = 0$	-47			
Output noise voltage, rms	$f = 10\text{ Hz}$ to $10\text{ kHz}$	$C_{NR} = 0$	120		$\mu\text{V}$
		$C_{NR} = 1\ \mu\text{F}$	30		
Output voltage current step response	$V_O$ to 0.1%, $I_O = \pm 10\text{ mA}$	$C_L = 0$	290		$\mu\text{s}$
		$C_L = 100\text{ pF}$	275		
	$V_O$ to 0.01%, $I_O = \pm 10\text{ mA}$	$C_L = 0$	400		
		$C_L = 100\text{ pF}$	390		
Step response	$V_I = 0$ to $5\text{ V}$ , $V_O$ to 0.1%	$C_L = 100\text{ pF}$	20		$\mu\text{s}$
	$V_I = 0$ to $5\text{ V}$ , $V_O$ to 0.01%		160		

<sup>†</sup> The listed values are not production tested.

**electrical characteristics at specified free-air temperature,  $V_I = 12\text{ V}$ ,  $I_O = 0$ ,  $T_A = 25^\circ\text{C}$  (unless otherwise noted)**

PARAMETER	TEST CONDITIONS	TLE2426Y			UNIT
		MIN	TYP	MAX	
Output voltage	$V_I = 12\text{ V}$	6			V
Supply current	No load	195			$\mu\text{A}$
Output voltage regulation (sourcing current) <sup>†</sup>	$I_O = 0$ to $-10\text{ mA}$	-45			$\mu\text{V}$
	$I_O = 0$ to $-20\text{ mA}$	-150			
Output voltage regulation (sinking current) <sup>†</sup>	$I_O = 0$ to $3\text{ mA}$	15			$\mu\text{V}$
	$I_O = 0$ to $20\text{ mA}$	65			
Output impedance		7.5			$\text{m}\Omega$
Noise-reduction impedance		110			$\text{k}\Omega$
Short-circuit current	Sinking current, $V_O = 12\text{ V}$	31			mA
	Sourcing current, $V_O = 0$	-70			
Output noise voltage, rms	$f = 10\text{ Hz}$ to $10\text{ kHz}$	$C_{NR} = 0$	120		$\mu\text{V}$
		$C_{NR} = 1\ \mu\text{F}$	30		
Output voltage current, step response	$V_O$ to 0.1%, $I_O = \pm 10\text{ mA}$	$C_L = 0$	290		$\mu\text{s}$
		$C_L = 100\text{ pF}$	275		
	$V_O$ to 0.01%, $I_O = \pm 10\text{ mA}$	$C_L = 0$	400		
		$C_L = 100\text{ pF}$	390		
Step response	$V_I = 0$ to $12\text{ V}$ , $V_O$ to 0.1%	$C_L = 100\text{ pF}$	12		$\mu\text{s}$
	$V_I = 0$ to $12\text{ V}$ , $V_O$ to 0.01%		120		

<sup>†</sup> The listed values are not production tested.

**TYPICAL CHARACTERISTICS**

**Table Of Graphs**

		<b>FIGURE</b>
Output voltage	Distribution	1,2
Output voltage change	vs Free-air temperature	3
Output voltage error	vs Input voltage	4
Input bias current	vs Input voltage	5
	vs Free-air temperature	6
Output voltage regulation	vs Output current	7
Output impedance	vs Frequency	8
Short-circuit output current	vs Input voltage	9,10
	vs Free-air temperature	11,12
Ripple rejection	vs Frequency	13
Spectral noise voltage density	vs Frequency	14
Output voltage response to output current step	vs Time	15
Output voltage power-up response	vs Time	16
Output current	vs Load capacitance	17

TYPICAL CHARACTERISTICS†

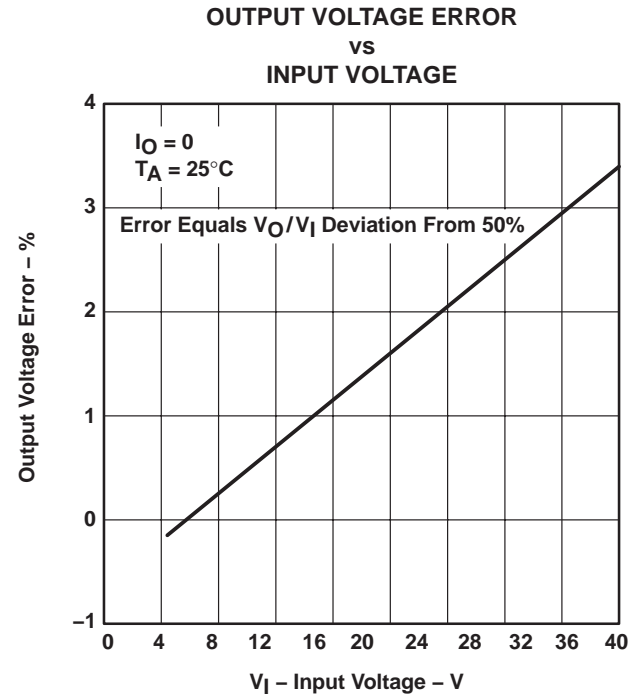
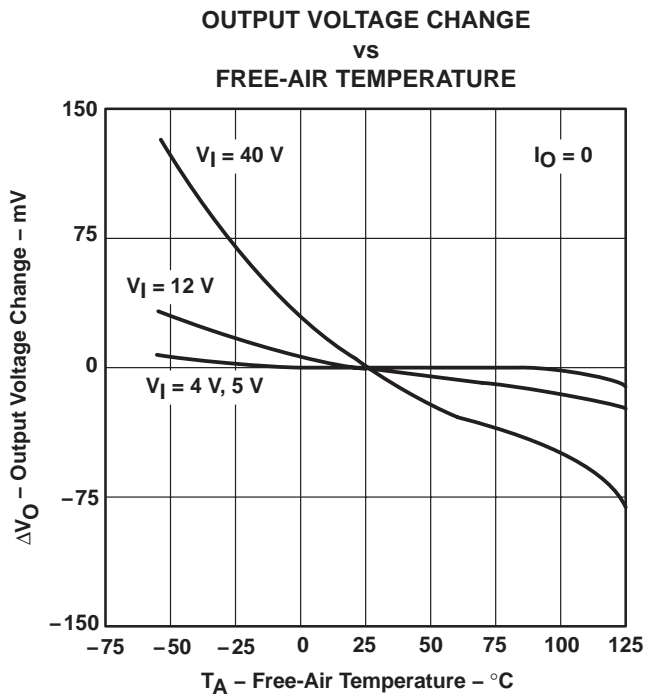
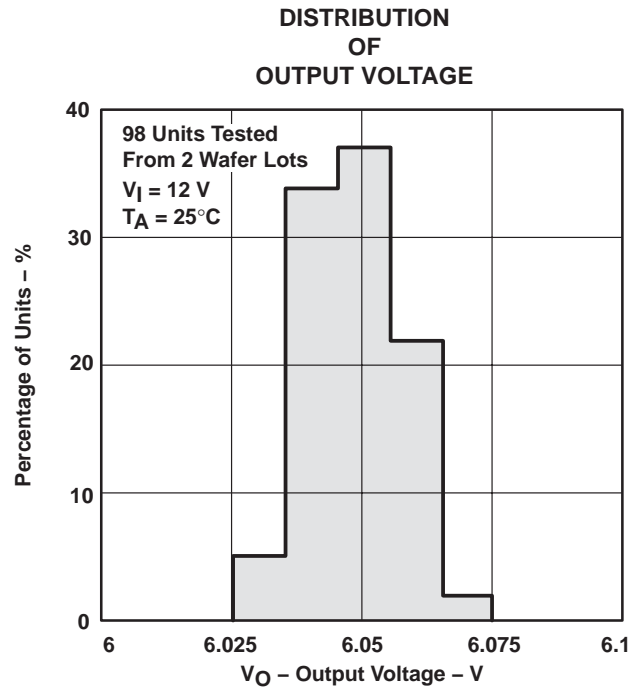
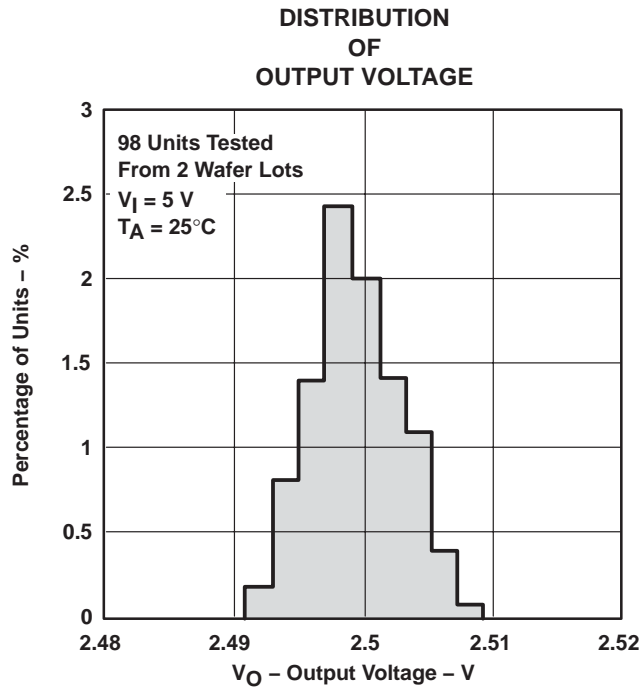

† Data at high and low temperatures are applicable within the rated operating free-air temperature ranges of the various devices.

**TYPICAL CHARACTERISTICS†**

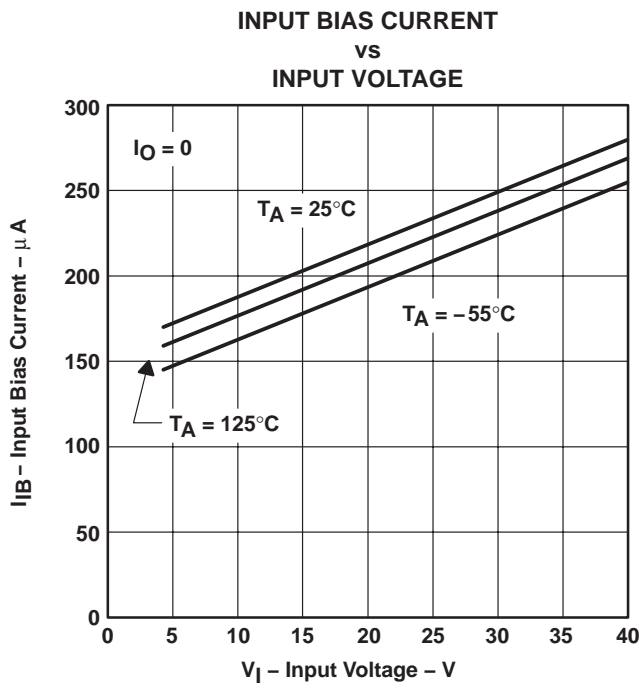

**Figure 5**

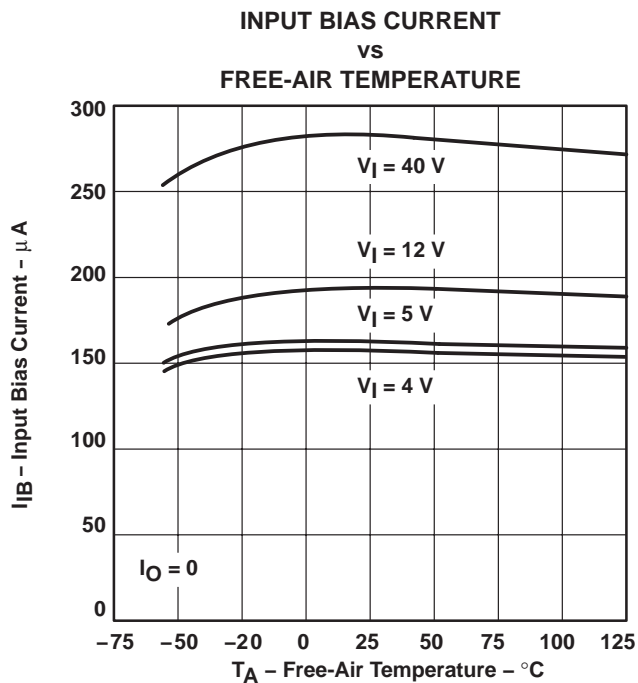

**Figure 6**

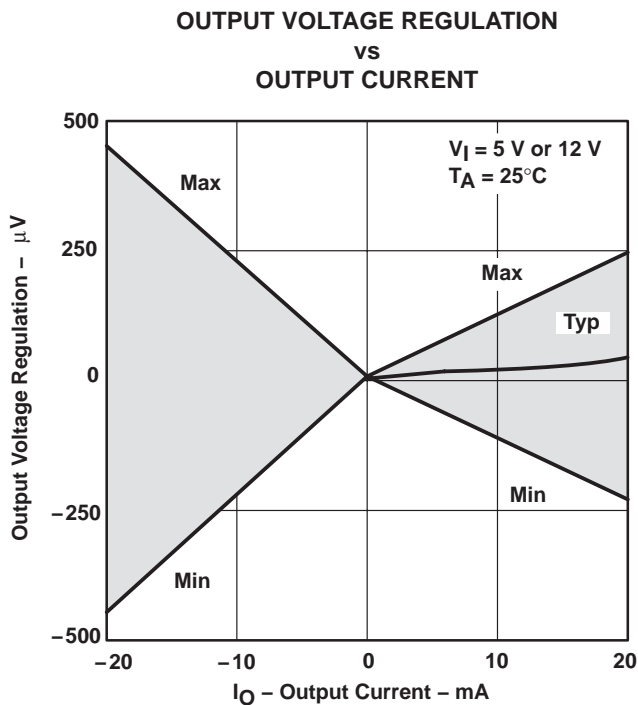

**Figure 7**

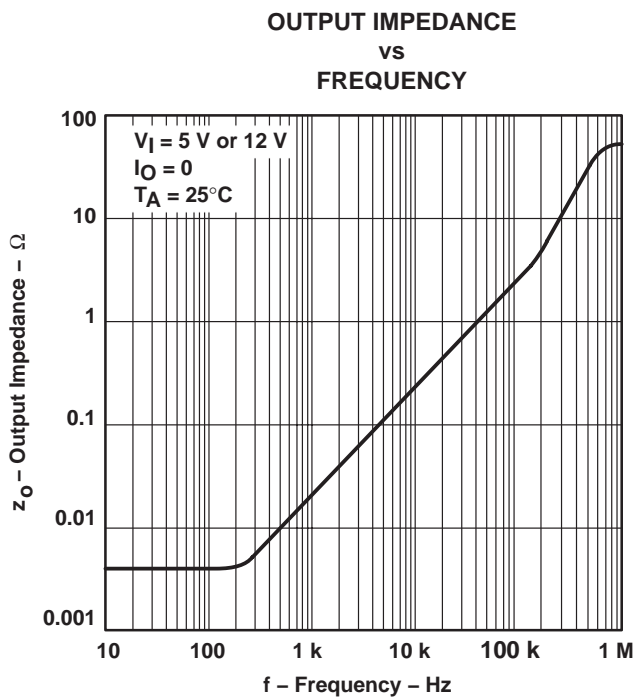

**Figure 8**

† Data at high and low temperatures are applicable within the rated operating free-air temperature ranges of the various devices.

TYPICAL CHARACTERISTICS†

SHORT-CIRCUIT OUTPUT CURRENT  
 vs  
 INPUT VOLTAGE

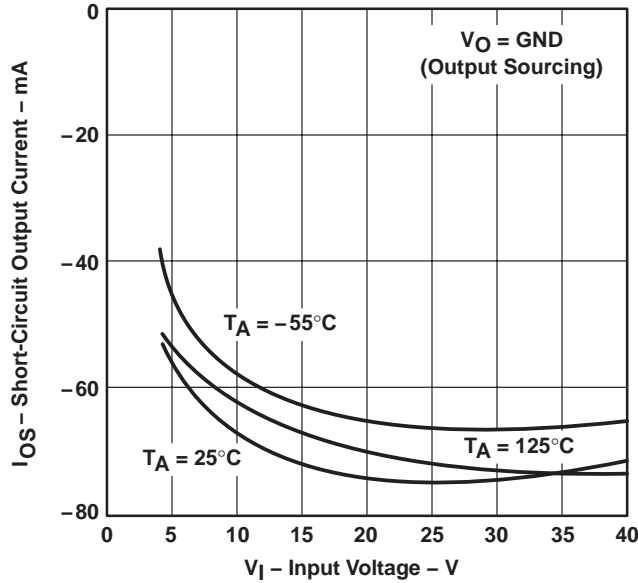

Figure 9

SHORT-CIRCUIT OUTPUT CURRENT  
 vs  
 INPUT VOLTAGE

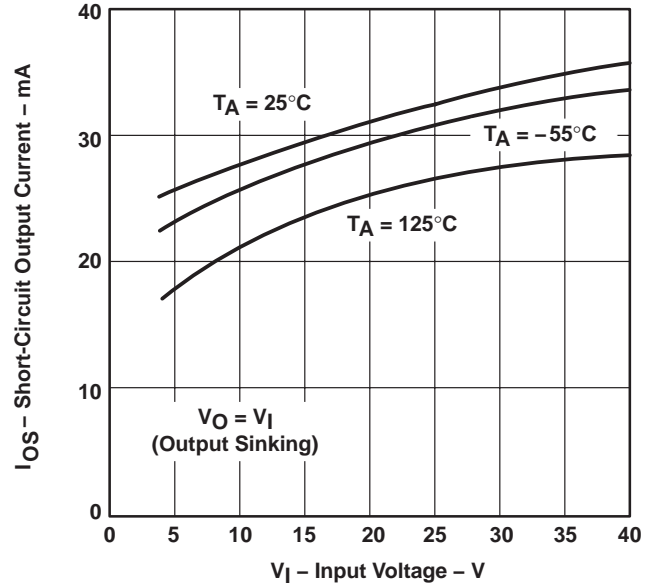

Figure 10

SHORT-CIRCUIT OUTPUT CURRENT  
 vs  
 FREE-AIR TEMPERATURE

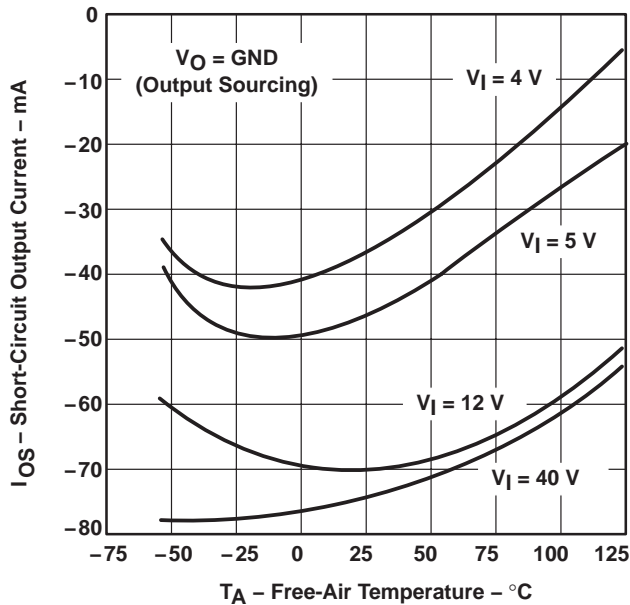

Figure 11

SHORT-CIRCUIT OUTPUT CURRENT  
 vs  
 FREE-AIR TEMPERATURE

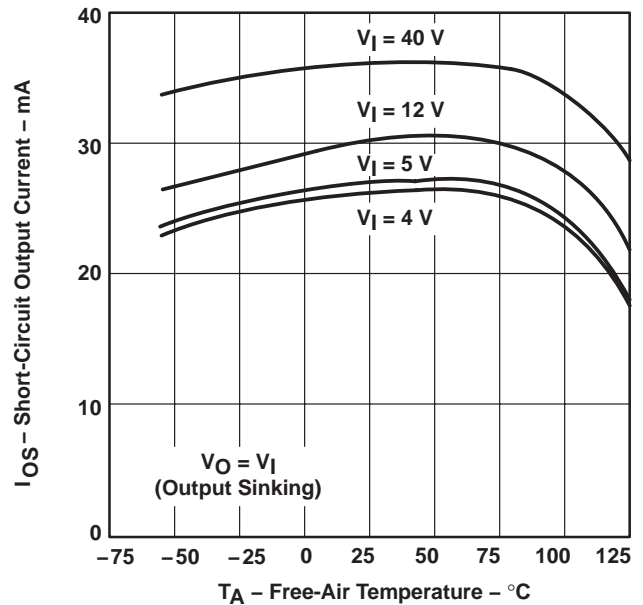

Figure 12

† Data at high and low temperatures are applicable within the rated operating free-air temperature ranges of the various devices.

**TLE2426, TLE2426Y**  
**THE "RAIL SPLITTER"**  
**PRECISION VIRTUAL GROUND**

SLOS098D – AUGUST 1991 – REVISED MAY 1998

**TYPICAL CHARACTERISTICS**

**RIPPLE REJECTION  
 vs  
 FREQUENCY**

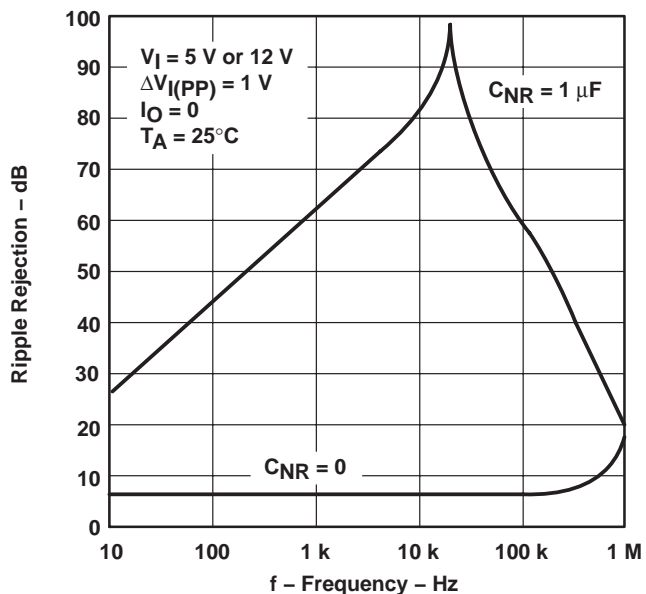

**Figure 13**

**SPECTRAL NOISE VOLTAGE DENSITY  
 vs  
 FREQUENCY**

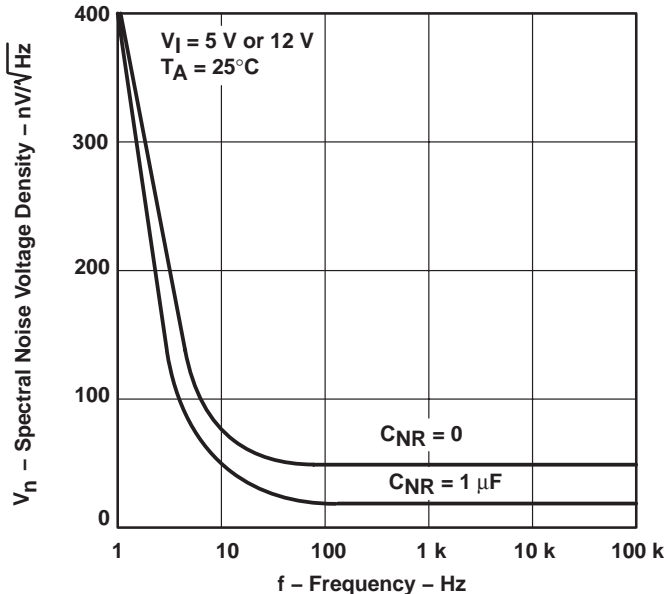

**Figure 14**

**OUTPUT VOLTAGE RESPONSE  
 TO OUTPUT CURRENT STEP**

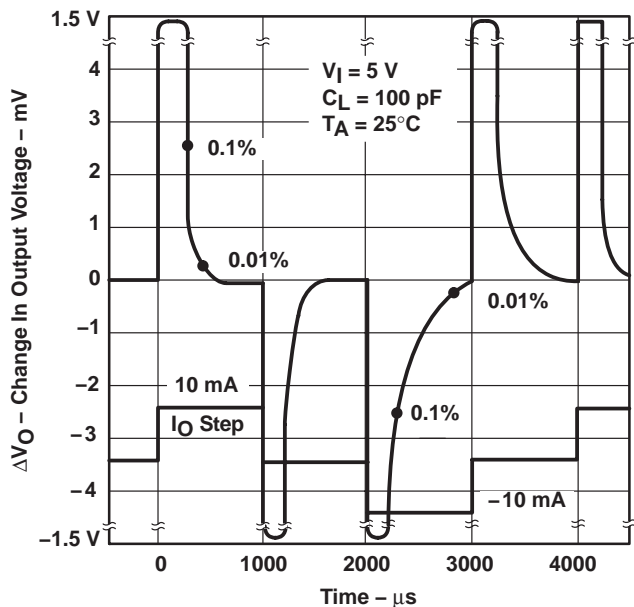

**Figure 15**

**OUTPUT VOLTAGE POWER-UP RESPONSE**

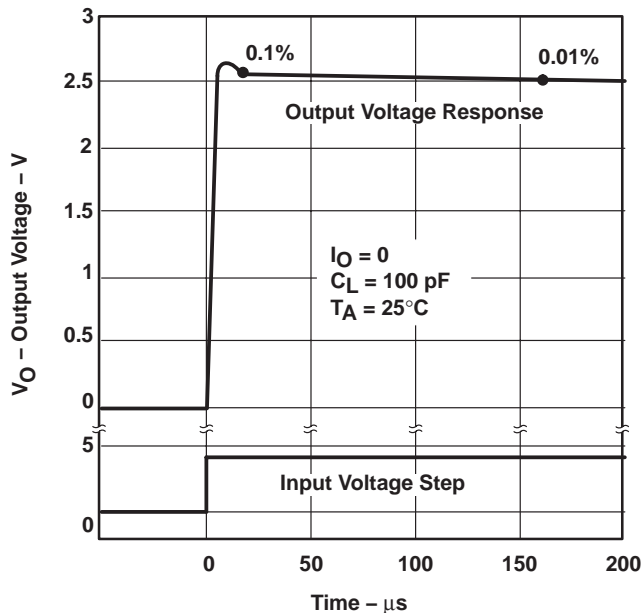

**Figure 16**





TYPICAL CHARACTERISTICS

STABILITY RANGE  
OUTPUT CURRENT  
VS  
LOAD CAPACITANCE

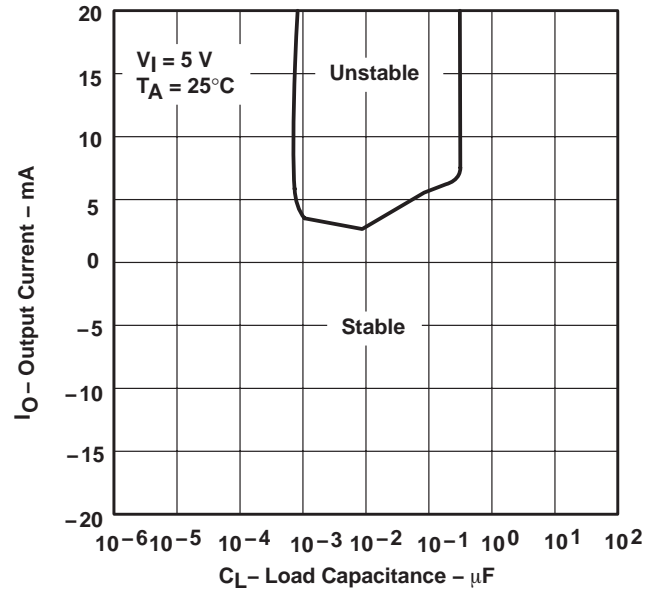

Figure 17



**PACKAGING INFORMATION**

Orderable Device	Status (1)	Package Type	Package Drawing	Pins	Package Qty	Eco Plan (2)	Lead/Ball Finish	MSL Peak Temp (3)	Op Temp (°C)	Top-Side Markings (4)	Samples
5962-9555602Q2A	OBSOLETE	LCCC	FK	20		TBD	Call TI	Call TI	-55 to 125		
5962-9555602QPA	OBSOLETE	CDIP	JG	8		TBD	Call TI	Call TI	-55 to 125		
TLE2426CD	ACTIVE	SOIC	D	8	75	Green (RoHS & no Sb/Br)	CU NIPDAU	Level-1-260C-UNLIM		2426C	<a href="#">Samples</a>
TLE2426CDG4	ACTIVE	SOIC	D	8	75	Green (RoHS & no Sb/Br)	CU NIPDAU	Level-1-260C-UNLIM		2426C	<a href="#">Samples</a>
TLE2426CDR	ACTIVE	SOIC	D	8	2500	Green (RoHS & no Sb/Br)	CU NIPDAU	Level-1-260C-UNLIM		2426C	<a href="#">Samples</a>
TLE2426CDRG4	ACTIVE	SOIC	D	8	2500	Green (RoHS & no Sb/Br)	CU NIPDAU	Level-1-260C-UNLIM		2426C	<a href="#">Samples</a>
TLE2426CLP	ACTIVE	TO-92	LP	3	1000	Pb-Free (RoHS)	CU SN	N / A for Pkg Type		2426C	<a href="#">Samples</a>
TLE2426CLPE3	ACTIVE	TO-92	LP	3	1000	Pb-Free (RoHS)	CU SN	N / A for Pkg Type		2426C	<a href="#">Samples</a>
TLE2426CLPR	ACTIVE	TO-92	LP	3	2000	Pb-Free (RoHS)	CU SN	N / A for Pkg Type		2426C	<a href="#">Samples</a>
TLE2426CLPRE3	ACTIVE	TO-92	LP	3	2000	Pb-Free (RoHS)	CU SN	N / A for Pkg Type		2426C	<a href="#">Samples</a>
TLE2426CP	ACTIVE	PDIP	P	8	50	Pb-Free (RoHS)	CU NIPDAU	N / A for Pkg Type		TLE2426CP	<a href="#">Samples</a>
TLE2426CPE4	ACTIVE	PDIP	P	8	50	Pb-Free (RoHS)	CU NIPDAU	N / A for Pkg Type		TLE2426CP	<a href="#">Samples</a>
TLE2426ID	ACTIVE	SOIC	D	8	75	Green (RoHS & no Sb/Br)	CU NIPDAU	Level-1-260C-UNLIM		2426I	<a href="#">Samples</a>
TLE2426IDG4	ACTIVE	SOIC	D	8	75	Green (RoHS & no Sb/Br)	CU NIPDAU	Level-1-260C-UNLIM		2426I	<a href="#">Samples</a>
TLE2426IDR	ACTIVE	SOIC	D	8	2500	Green (RoHS & no Sb/Br)	CU NIPDAU	Level-1-260C-UNLIM		2426I	<a href="#">Samples</a>
TLE2426IDRG4	ACTIVE	SOIC	D	8	2500	Green (RoHS & no Sb/Br)	CU NIPDAU	Level-1-260C-UNLIM		2426I	<a href="#">Samples</a>
TLE2426ILP	ACTIVE	TO-92	LP	3	1000	Pb-Free (RoHS)	CU SN	N / A for Pkg Type		2426I	<a href="#">Samples</a>
TLE2426ILPE3	ACTIVE	TO-92	LP	3	1000	Pb-Free (RoHS)	CU SN	N / A for Pkg Type		2426I	<a href="#">Samples</a>

Orderable Device	Status (1)	Package Type	Package Drawing	Pins	Package Qty	Eco Plan (2)	Lead/Ball Finish	MSL Peak Temp (3)	Op Temp (°C)	Top-Side Markings (4)	Samples
TLE2426ILPR	ACTIVE	TO-92	LP	3	2000	Pb-Free (RoHS)	CU SN	N / A for Pkg Type		2426I	<a href="#">Samples</a>
TLE2426ILPRE3	ACTIVE	TO-92	LP	3	2000	Pb-Free (RoHS)	CU SN	N / A for Pkg Type		2426I	<a href="#">Samples</a>
TLE2426IP	ACTIVE	PDIP	P	8	50	Pb-Free (RoHS)	CU NIPDAU	N / A for Pkg Type		TLE2426IP	<a href="#">Samples</a>
TLE2426IPE4	ACTIVE	PDIP	P	8	50	Pb-Free (RoHS)	CU NIPDAU	N / A for Pkg Type		TLE2426IP	<a href="#">Samples</a>
TLE2426MD	ACTIVE	SOIC	D	8	75	Green (RoHS & no Sb/Br)	CU NIPDAU	Level-1-260C-UNLIM	-55 to 125	2426M	<a href="#">Samples</a>
TLE2426MDG4	ACTIVE	SOIC	D	8	75	Green (RoHS & no Sb/Br)	CU NIPDAU	Level-1-260C-UNLIM	-55 to 125	2426M	<a href="#">Samples</a>
TLE2426MFKB	OBSOLETE	LCCC	FK	20		TBD	Call TI	Call TI	-55 to 125		
TLE2426MJGB	OBSOLETE	CDIP	JG	8		TBD	Call TI	Call TI	-55 to 125		
TLE2426MLP	OBSOLETE	TO-92	LP	3		TBD	Call TI	Call TI	-55 to 125		
TLE2426MP	OBSOLETE	PDIP	P	8		TBD	Call TI	Call TI	-55 to 125		

(1) The marketing status values are defined as follows:

**ACTIVE:** Product device recommended for new designs.

**LIFEBUY:** TI has announced that the device will be discontinued, and a lifetime-buy period is in effect.

**NRND:** Not recommended for new designs. Device is in production to support existing customers, but TI does not recommend using this part in a new design.

**PREVIEW:** Device has been announced but is not in production. Samples may or may not be available.

**OBSOLETE:** TI has discontinued the production of the device.

(2) Eco Plan - The planned eco-friendly classification: Pb-Free (RoHS), Pb-Free (RoHS Exempt), or Green (RoHS & no Sb/Br) - please check <http://www.ti.com/productcontent> for the latest availability information and additional product content details.

**TBD:** The Pb-Free/Green conversion plan has not been defined.

**Pb-Free (RoHS):** TI's terms "Lead-Free" or "Pb-Free" mean semiconductor products that are compatible with the current RoHS requirements for all 6 substances, including the requirement that lead not exceed 0.1% by weight in homogeneous materials. Where designed to be soldered at high temperatures, TI Pb-Free products are suitable for use in specified lead-free processes.

**Pb-Free (RoHS Exempt):** This component has a RoHS exemption for either 1) lead-based flip-chip solder bumps used between the die and package, or 2) lead-based die adhesive used between the die and leadframe. The component is otherwise considered Pb-Free (RoHS compatible) as defined above.

**Green (RoHS & no Sb/Br):** TI defines "Green" to mean Pb-Free (RoHS compatible), and free of Bromine (Br) and Antimony (Sb) based flame retardants (Br or Sb do not exceed 0.1% by weight in homogeneous material)

(3) MSL, Peak Temp. -- The Moisture Sensitivity Level rating according to the JEDEC industry standard classifications, and peak solder temperature.

(4) Only one of markings shown within the brackets will appear on the physical device.

**Important Information and Disclaimer:** The information provided on this page represents TI's knowledge and belief as of the date that it is provided. TI bases its knowledge and belief on information provided by third parties, and makes no representation or warranty as to the accuracy of such information. Efforts are underway to better integrate information from third parties. TI has taken and continues to take reasonable steps to provide representative and accurate information but may not have conducted destructive testing or chemical analysis on incoming materials and chemicals. TI and TI suppliers consider certain information to be proprietary, and thus CAS numbers and other limited information may not be available for release.

In no event shall TI's liability arising out of such information exceed the total purchase price of the TI part(s) at issue in this document sold by TI to Customer on an annual basis.

**OTHER QUALIFIED VERSIONS OF TLE2426 :**

- Automotive: [TLE2426-Q1](#)
- Enhanced Product: [TLE2426-EP](#)

NOTE: Qualified Version Definitions:

- Automotive - Q100 devices qualified for high-reliability automotive applications targeting zero defects
- Enhanced Product - Supports Defense, Aerospace and Medical Applications

## TAPE AND REEL INFORMATION



### QUADRANT ASSIGNMENTS FOR PIN 1 ORIENTATION IN TAPE



\*All dimensions are nominal

Device	Package Type	Package Drawing	Pins	SPQ	Reel Diameter (mm)	Reel Width W1 (mm)	A0 (mm)	B0 (mm)	K0 (mm)	P1 (mm)	W (mm)	Pin1 Quadrant
TLE2426CDR	SOIC	D	8	2500	330.0	12.4	6.4	5.2	2.1	8.0	12.0	Q1
TLE2426IDR	SOIC	D	8	2500	330.0	12.4	6.4	5.2	2.1	8.0	12.0	Q1

**TAPE AND REEL BOX DIMENSIONS**



\*All dimensions are nominal

Device	Package Type	Package Drawing	Pins	SPQ	Length (mm)	Width (mm)	Height (mm)
TLE2426CDR	SOIC	D	8	2500	367.0	367.0	35.0
TLE2426IDR	SOIC	D	8	2500	367.0	367.0	35.0

JG (R-GDIP-T8)

CERAMIC DUAL-IN-LINE



- NOTES: A. All linear dimensions are in inches (millimeters).  
 B. This drawing is subject to change without notice.  
 C. This package can be hermetically sealed with a ceramic lid using glass frit.  
 D. Index point is provided on cap for terminal identification.  
 E. Falls within MIL STD 1835 GDIP1-T8



FK (S-CQCC-N\*\*)

LEADLESS CERAMIC CHIP CARRIER

28 TERMINAL SHOWN



NO. OF TERMINALS **	A		B	
	MIN	MAX	MIN	MAX
20	0.342 (8,69)	0.358 (9,09)	0.307 (7,80)	0.358 (9,09)
28	0.442 (11,23)	0.458 (11,63)	0.406 (10,31)	0.458 (11,63)
44	0.640 (16,26)	0.660 (16,76)	0.495 (12,58)	0.560 (14,22)
52	0.740 (18,78)	0.761 (19,32)	0.495 (12,58)	0.560 (14,22)
68	0.938 (23,83)	0.962 (24,43)	0.850 (21,6)	0.858 (21,8)
84	1.141 (28,99)	1.165 (29,59)	1.047 (26,6)	1.063 (27,0)



4040140/D 01/11

- NOTES:
- All linear dimensions are in inches (millimeters).
  - This drawing is subject to change without notice.
  - This package can be hermetically sealed with a metal lid.
  - Falls within JEDEC MS-004

P (R-PDIP-T8)

PLASTIC DUAL-IN-LINE PACKAGE

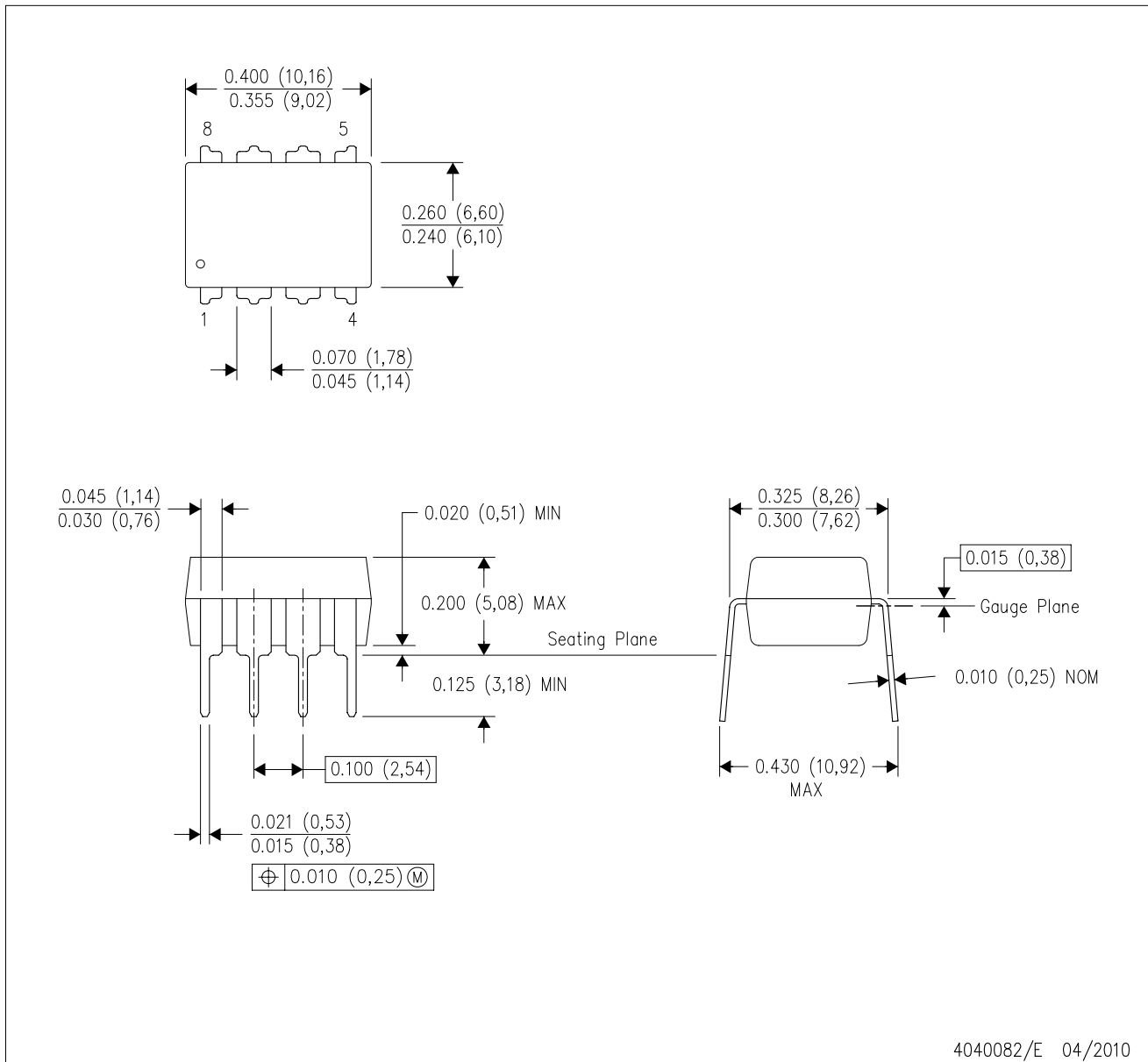

- NOTES:
- A. All linear dimensions are in inches (millimeters).
  - B. This drawing is subject to change without notice.
  - C. Falls within JEDEC MS-001 variation BA.

D (R-PDSO-G8)

PLASTIC SMALL OUTLINE

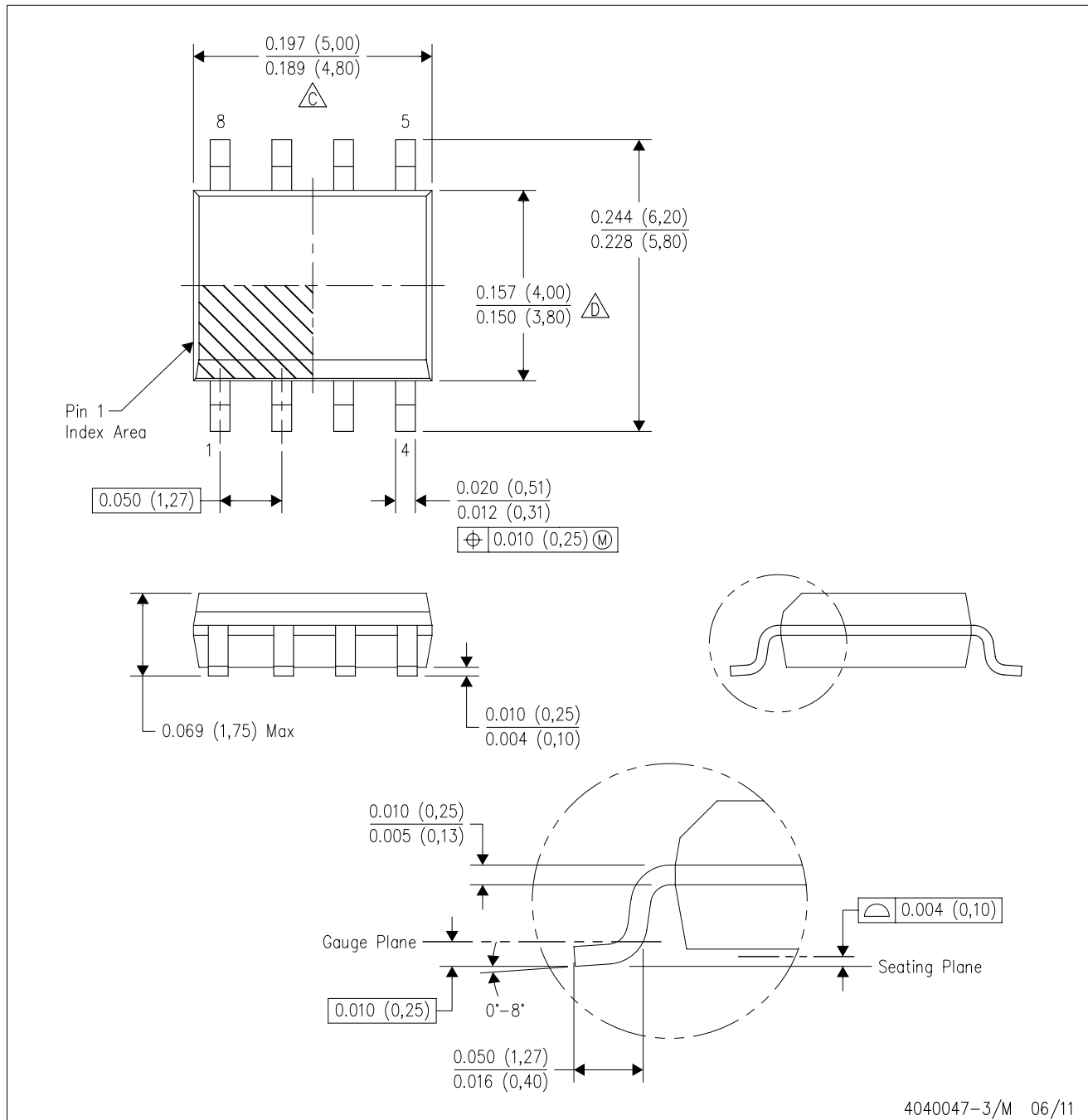

- NOTES:
- A. All linear dimensions are in inches (millimeters).
  - B. This drawing is subject to change without notice.
  - C. Body length does not include mold flash, protrusions, or gate burrs. Mold flash, protrusions, or gate burrs shall not exceed 0.006 (0,15) each side.
  - D. Body width does not include interlead flash. Interlead flash shall not exceed 0.017 (0,43) each side.
  - E. Reference JEDEC MS-012 variation AA.

LP (O-PBCY-W3)

PLASTIC CYLINDRICAL PACKAGE

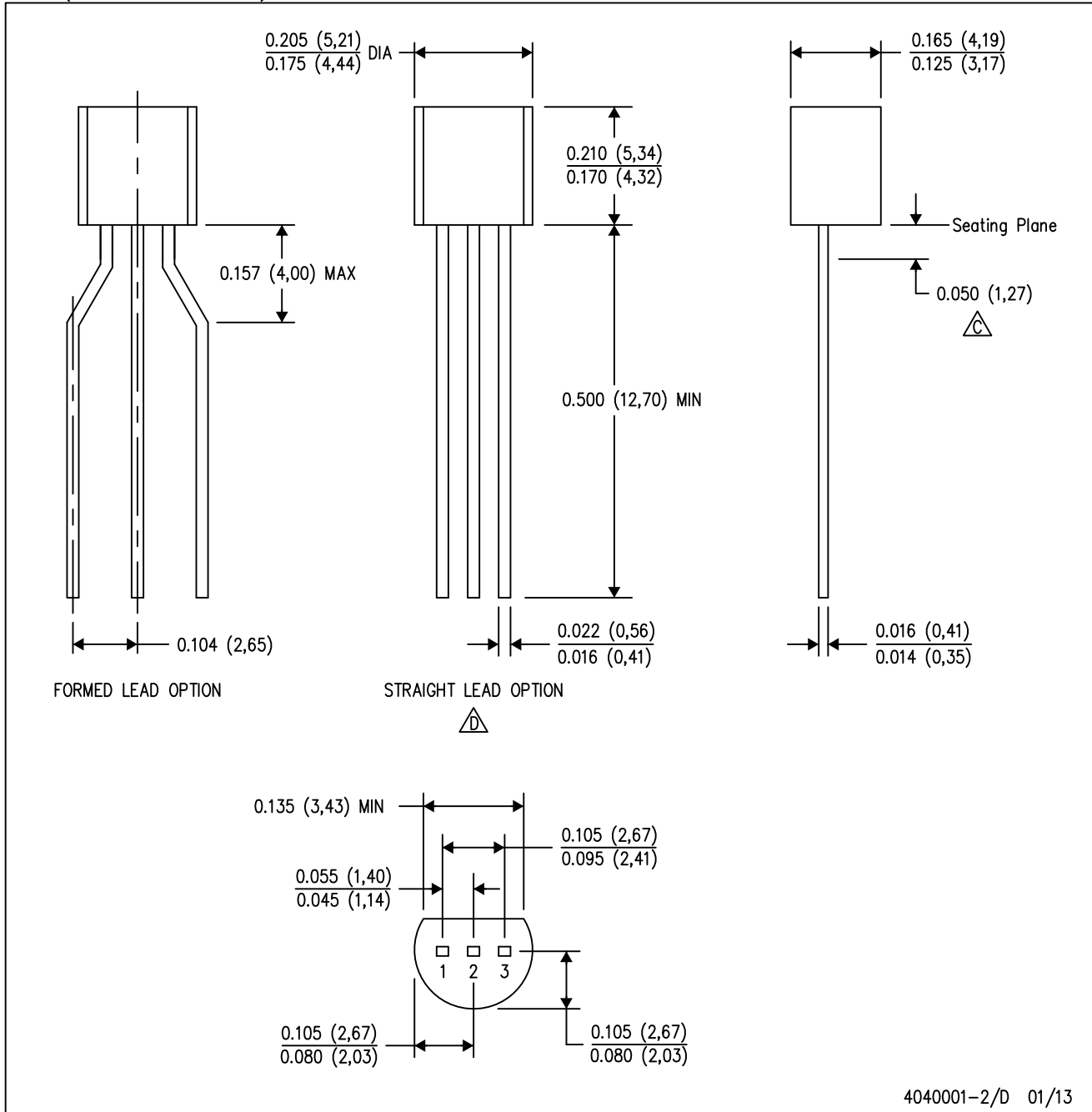

4040001-2/D 01/13

# MECHANICAL DATA

LP (O-PBCY-W3)

PLASTIC CYLINDRICAL PACKAGE

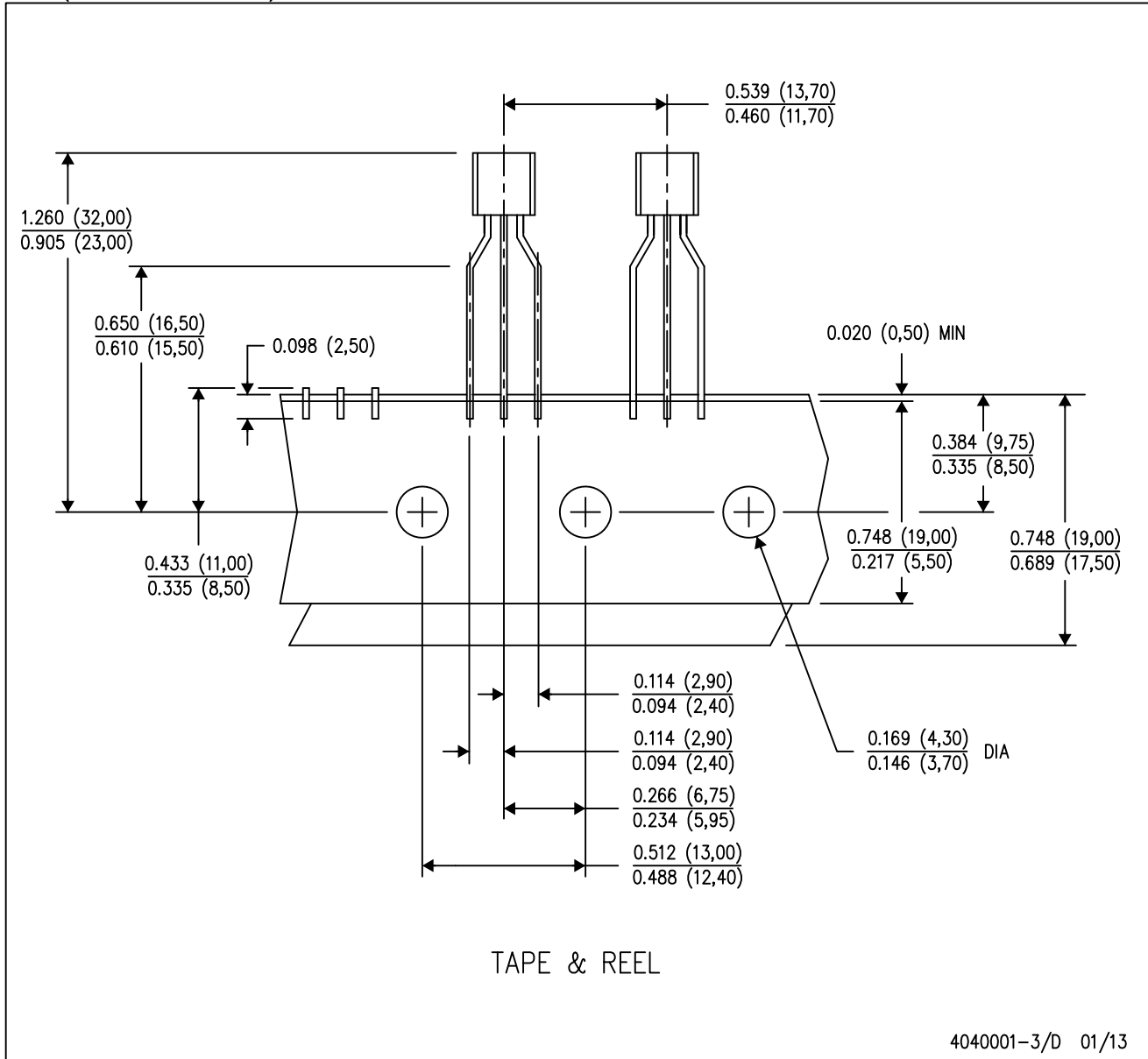

- NOTES:
- A. All linear dimensions are in inches (millimeters).
  - B. This drawing is subject to change without notice.
  - C. Tape and Reel information for the Formed Lead Option package.

## IMPORTANT NOTICE

Texas Instruments Incorporated and its subsidiaries (TI) reserve the right to make corrections, enhancements, improvements and other changes to its semiconductor products and services per JESD46, latest issue, and to discontinue any product or service per JESD48, latest issue. Buyers should obtain the latest relevant information before placing orders and should verify that such information is current and complete. All semiconductor products (also referred to herein as "components") are sold subject to TI's terms and conditions of sale supplied at the time of order acknowledgment.

TI warrants performance of its components to the specifications applicable at the time of sale, in accordance with the warranty in TI's terms and conditions of sale of semiconductor products. Testing and other quality control techniques are used to the extent TI deems necessary to support this warranty. Except where mandated by applicable law, testing of all parameters of each component is not necessarily performed.

TI assumes no liability for applications assistance or the design of Buyers' products. Buyers are responsible for their products and applications using TI components. To minimize the risks associated with Buyers' products and applications, Buyers should provide adequate design and operating safeguards.

TI does not warrant or represent that any license, either express or implied, is granted under any patent right, copyright, mask work right, or other intellectual property right relating to any combination, machine, or process in which TI components or services are used. Information published by TI regarding third-party products or services does not constitute a license to use such products or services or a warranty or endorsement thereof. Use of such information may require a license from a third party under the patents or other intellectual property of the third party, or a license from TI under the patents or other intellectual property of TI.

Reproduction of significant portions of TI information in TI data books or data sheets is permissible only if reproduction is without alteration and is accompanied by all associated warranties, conditions, limitations, and notices. TI is not responsible or liable for such altered documentation. Information of third parties may be subject to additional restrictions.

Resale of TI components or services with statements different from or beyond the parameters stated by TI for that component or service voids all express and any implied warranties for the associated TI component or service and is an unfair and deceptive business practice. TI is not responsible or liable for any such statements.

Buyer acknowledges and agrees that it is solely responsible for compliance with all legal, regulatory and safety-related requirements concerning its products, and any use of TI components in its applications, notwithstanding any applications-related information or support that may be provided by TI. Buyer represents and agrees that it has all the necessary expertise to create and implement safeguards which anticipate dangerous consequences of failures, monitor failures and their consequences, lessen the likelihood of failures that might cause harm and take appropriate remedial actions. Buyer will fully indemnify TI and its representatives against any damages arising out of the use of any TI components in safety-critical applications.

In some cases, TI components may be promoted specifically to facilitate safety-related applications. With such components, TI's goal is to help enable customers to design and create their own end-product solutions that meet applicable functional safety standards and requirements. Nonetheless, such components are subject to these terms.

No TI components are authorized for use in FDA Class III (or similar life-critical medical equipment) unless authorized officers of the parties have executed a special agreement specifically governing such use.

Only those TI components which TI has specifically designated as military grade or "enhanced plastic" are designed and intended for use in military/aerospace applications or environments. Buyer acknowledges and agrees that any military or aerospace use of TI components which have **not** been so designated is solely at the Buyer's risk, and that Buyer is solely responsible for compliance with all legal and regulatory requirements in connection with such use.

TI has specifically designated certain components as meeting ISO/TS16949 requirements, mainly for automotive use. In any case of use of non-designated products, TI will not be responsible for any failure to meet ISO/TS16949.

### Products

Audio	<a href="http://www.ti.com/audio">www.ti.com/audio</a>
Amplifiers	<a href="http://amplifier.ti.com">amplifier.ti.com</a>
Data Converters	<a href="http://dataconverter.ti.com">dataconverter.ti.com</a>
DLP® Products	<a href="http://www.dlp.com">www.dlp.com</a>
DSP	<a href="http://dsp.ti.com">dsp.ti.com</a>
Clocks and Timers	<a href="http://www.ti.com/clocks">www.ti.com/clocks</a>
Interface	<a href="http://interface.ti.com">interface.ti.com</a>
Logic	<a href="http://logic.ti.com">logic.ti.com</a>
Power Mgmt	<a href="http://power.ti.com">power.ti.com</a>
Microcontrollers	<a href="http://microcontroller.ti.com">microcontroller.ti.com</a>
RFID	<a href="http://www.ti-rfid.com">www.ti-rfid.com</a>
OMAP Applications Processors	<a href="http://www.ti.com/omap">www.ti.com/omap</a>
Wireless Connectivity	<a href="http://www.ti.com/wirelessconnectivity">www.ti.com/wirelessconnectivity</a>

### Applications

Automotive and Transportation	<a href="http://www.ti.com/automotive">www.ti.com/automotive</a>
Communications and Telecom	<a href="http://www.ti.com/communications">www.ti.com/communications</a>
Computers and Peripherals	<a href="http://www.ti.com/computers">www.ti.com/computers</a>
Consumer Electronics	<a href="http://www.ti.com/consumer-apps">www.ti.com/consumer-apps</a>
Energy and Lighting	<a href="http://www.ti.com/energy">www.ti.com/energy</a>
Industrial	<a href="http://www.ti.com/industrial">www.ti.com/industrial</a>
Medical	<a href="http://www.ti.com/medical">www.ti.com/medical</a>
Security	<a href="http://www.ti.com/security">www.ti.com/security</a>
Space, Avionics and Defense	<a href="http://www.ti.com/space-avionics-defense">www.ti.com/space-avionics-defense</a>
Video and Imaging	<a href="http://www.ti.com/video">www.ti.com/video</a>

### TI E2E Community

[e2e.ti.com](http://e2e.ti.com)

# AMEYA360

Components Supply Platform

Authorized Distribution Brand :



Website :

Welcome to visit [www.ameya360.com](http://www.ameya360.com)

Contact Us :

➤ Address :

401 Building No.5, JiuGe Business Center, Lane 2301, Yishan Rd  
Minhang District, Shanghai , China

➤ Sales :

Direct +86 (21) 6401-6692

Email [amall@ameya360.com](mailto:amall@ameya360.com)

QQ 800077892

Skype [ameyasales1](#) [ameyasales2](#)

➤ Customer Service :

Email [service@ameya360.com](mailto:service@ameya360.com)

➤ Partnership :

Tel +86 (21) 64016692-8333

Email [mkt@ameya360.com](mailto:mkt@ameya360.com)