

12-A Step-Down Regulator with Integrated Switcher

Check for Samples: [TPS53315](#)

FEATURES

- Conversion Input Voltage Range: 3 V to 15 V
- VDD Input Voltage Range: 4.5 V to 25 V
- Output Voltage Range: 0.6 V to 5.5 V
- 5-V LDO Output
- Integrated Power MOSFETs with 12-A Continuous Output Current
- <math><10\text{-}\mu\text{A}</math> Shut Down Current
- Auto-Skip Eco-mode™ for Light-Load Efficiency
- D-CAP™ Mode with Fast Transient Response
- Selectable Switching Frequency from 250 kHz to 1 MHz with an External Resistor
- Built-in 1%, 0.6-V Reference
- 0.7-ms, 1.4-ms, 2.8-ms and 5.6-ms Selectable Internal Voltage Servo Soft-Start
- Pre-Charged Start-up Capability
- Integrated Boost Switch
- Adjustable Overcurrent Limit Via External Resistor
- Overvoltage/Undervoltage, UVLO and Over-Temperature Protection
- Support All Ceramic Output Capacitors
- Open Drain Power Good Indication
- 40-pin QFN Package with PowerPAD™

APPLICATIONS

- Server and Desktop Computers
- Notebook Computers
- Telecommunication Equipments

DESCRIPTION

TPS53315 is a D-CAP™ mode, 12-A synchronous switcher with integrated MOSFETs. It is designed for ease of use, low external component count, and small package power systems.

This device features single-rail input support, one 19-mΩ and one 7-mΩ integrated MOSFET, accurate 1%, 0.6 V Reference, and integrated boost switch. A sample of competitive features include: greater than 96% maximum efficiency, 3 V to 15 V wide input voltage range, very low external component count, D-CAP™ mode control for super fast transient, selectable auto-skip and PWM operation, internal soft-start control, adjustable frequency, and no need for compensation.

The conversion input voltage ranges from 3 V to 15 V, the supply voltage range is from 4.5 V to 25 V, and the output voltage range is from 0.6 V to 5.5 V.

The TPS53315 is available in a 5 mm × 7 mm 40-pin, QFN package and is specified from –40°C to 85°C.

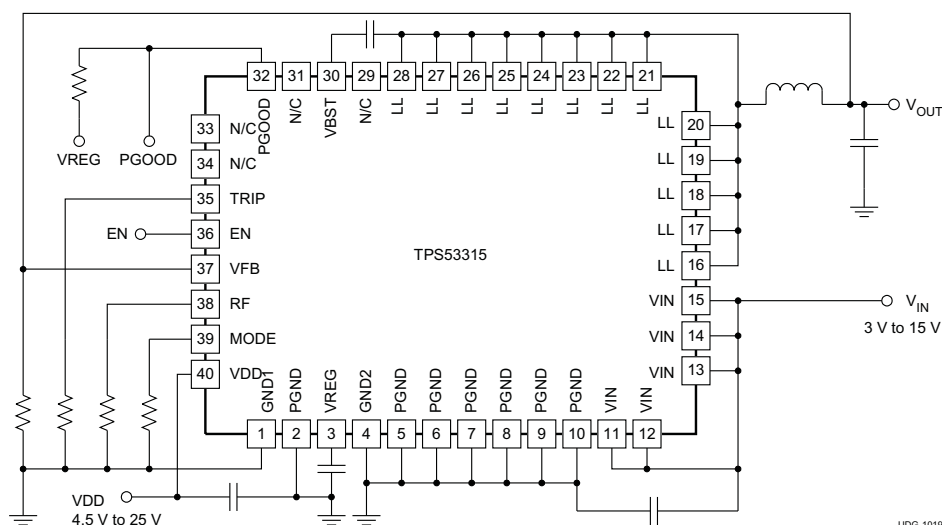

UDG-10199



Please be aware that an important notice concerning availability, standard warranty, and use in critical applications of Texas Instruments semiconductor products and disclaimers thereto appears at the end of this data sheet.

Eco-mode, D-CAP, PowerPAD are trademarks of Texas Instruments.



These devices have limited built-in ESD protection. The leads should be shorted together or the device placed in conductive foam during storage or handling to prevent electrostatic damage to the MOS gates.

ORDERING INFORMATION⁽¹⁾

T _A	PACKAGE	ORDERING NUMBER	PINS	TRANSPORT MEDIA	MINIMUM QUANTITY	ECO PLAN
-40°C to 85°C	Plastic QFN (RGF)	TPS53315RGFR	40	Tape and reel	3000	Green (RoHS and no Pb/Br)
		TPS53315RGFT	40	Mini reel	250	

(1) For the most current package and ordering information, see the *Package Option Addendum* at the end of this document, or see the TI web site at www.ti.com.

ABSOLUTE MAXIMUM RATINGS⁽¹⁾

		VALUE	UNIT	
Input voltage range	VIN (main supply)	-0.3 to 17	V	
	VDD	-0.3 to 28		
	VBST	-0.3 to 24		
	VBST(with respect to LL)	-0.3 to 7		
	EN, TRIP, VFB, RF, MODE	-0.3 to 7		
Output voltage range	LL	DC	-1 to 23	V
		Pulse < 20 ns, E = 5 μJ	-7	
	PGOOD, VREG	-0.3 to 7		
	PGND	-0.3 to 0.3		
Source/Sink Current	VBST	50	mA	
Operating free-air temperature, T _A		-40 to 85	°C	
Storage temperature range, T _{stg}		-55 to 150	°C	
Junction temperature range, T _J		-40 to 150	°C	
Lead temperature 1,6 mm (1/16 inch) from case for 10 seconds		300	°C	

(1) Stresses beyond those listed under “absolute maximum ratings” may cause permanent damage to the device. These are stress ratings only and functional operation of the device at these or any other conditions beyond those indicated under “recommended operating conditions” is not implied. Exposure to absolute-maximum-rated conditions for extended periods may affect device reliability.

THERMAL INFORMATION

THERMAL METRIC ⁽¹⁾		TPS53315	UNITS
		RGF(40 PINS)	
θ _{JA}	Junction-to-ambient thermal resistance	35.8	°C/W
θ _{JCtop}	Junction-to-case (top) thermal resistance	23.8	
θ _{JB}	Junction-to-board thermal resistance	10.1	
ψ _{JT}	Junction-to-top characterization parameter	0.4	
ψ _{JB}	Junction-to-board characterization parameter	10.0	
θ _{JCbot}	Junction-to-case (bottom) thermal resistance	2.8	

(1) For more information about traditional and new thermal metrics, see the *IC Package Thermal Metrics* application report, [SPRA953](http://sprae953).

RECOMMENDED OPERATING CONDITIONS

		VALUE	UNIT
Input voltage range	VIN (main supply)	3 to 15	V
	VDD	4.5 to 25	
	VBST	4.5 to 21	
	VBST(with respect to LL)	4.5 to 6.5	
	EN, TRIP, VFB, RF, MODE	-0.1 to 6.5	
Output voltage range	LL	-0.8 to 15	V
	PGOOD, VREG	-0.1 to 6.5	
Source/Sink Current	VBST	50	mA
Junction temperature range, T _J		-40 to 125	°C

ELECTRICAL CHARACTERISTICS

Over recommended free-air temperature range, VDD = 12 V (Unless otherwise noted)

PARAMETER		CONDITIONS	MIN	TYP	MAX	UNIT
SUPPLY VOLTAGE AND SUPPLY CURRENT						
V _{VIN}	VIN pin power conversion input voltage		3		15	V
V _{DD}	Supply input voltage		4.5		25	V
I _{VIN(leak)}	VIN pin leakage current	V _{EN} = 0 V			1	μA
I _{VDD}	VDD supply current	VDD current, T _A = 25°C, No Load, V _{EN} = 5 V, V _{VFB} = 0.630 V		420	590	μA
I _{VDDSDN}	VDD shutdown current	VDD current, T _A = 25°C, No Load, V _{EN} = 0 V			10	μA
INTERNAL REFERENCE VOLTAGE						
V _{VFB}	VFB regulation voltage	VFB voltage, CCM condition ⁽¹⁾		0.6000		V
		T _A = 25°C	0.597	0.600	0.603	V
		T _A = 0°C to 85°C	0.5952	0.600	0.6048	
		T _A = -40°C to 85°C	0.594	0.600	0.606	
I _{VFB}	VFB input current	V _{VFB} = 0.630 V, T _A = 25°C		0.002	0.2	μA
LDO OUTPUT						
V _{VREG}	LDO output voltage	0 mA ≤ I _{VREG} ≤ 30 mA	4.77	5.0	5.35	V
I _{VREG}	LDO output current ⁽¹⁾	Maximum current allowed from LDO			30	mA
V _{DO}	LDO drop out voltage	V _{DD} = 4.5 V, I _{VREG} = 30 mA			295	mV
BOOT STRAP SWITCH						
V _{FBST}	Forward voltage	V _{VREG-VBST} , I _F = 10 mA, T _A = 25°C		0.1	0.2	V
I _{VBSTLK}	VBST leakage current	V _{VBST} = 23 V, V _{LL} = 17 V, T _A = 25°C		0.01	1.5	μA
DUTY AND FREQUENCY CONTROL						
t _{OFF(min)}	Minimum off time	T _A = 25°C	150	260	400	ns
t _{ON(min)}	Minimum on time	V _{VIN} = 17 V, V _{OUT} = 0.6 V, R _{RF} = 0 Ω to V _{VREG} , T _A = 25°C ⁽¹⁾		35		
SOFTSTART						
t _{SS}	Internal SS time from V _{OUT} = 0 to V _{OUT} = 95%	R _{MODE} = 39 kΩ		0.7		ms
		R _{MODE} = 100 kΩ		1.4		
		R _{MODE} = 200 kΩ		2.8		
		R _{MODE} = 470 kΩ		5.6		
POWERGOOD						
V _{THPG}	PG threshold	PG in from lower	92.5%	96%	98.5%	
		PG in from higher	107.5%	110%	112.5%	
		PG hysteresis	2.5%	5%	7.8%	
R _{PG}	PG transistor on-resistance		15	30	55	Ω
t _{PGDEL}	PG Delay after soft-start		0.8	1	1.2	ms

(1) Ensured by design. Not production tested.

ELECTRICAL CHARACTERISTICS

Over recommended free-air temperature range, VDD = 12 V (Unless otherwise noted)

PARAMETER		TEST CONDITIONS	MIN	TYP	MAX	UNIT
LOGIC THRESHOLD AND SETTING CONDITIONS						
V _{EN}	EN voltage threshold	Enable	1.8			V
		Disable			0.6	
I _{EN}	EN input current	V _{EN} = 5 V			1.0	μA
f _{SW}	Switching frequency	R _{RF} = 0 Ω to GND, T _A = 25°C ⁽¹⁾	200	250	300	kHz
		R _{RF} = 187 kΩ to GND, T _A = 25°C ⁽¹⁾	250	300	350	
		R _{RF} = 619 kΩ to GND, T _A = 25°C ⁽¹⁾	350	400	450	
		R _{RF} = Open, T _A = 25°C ⁽¹⁾	450	500	550	
		R _{RF} = 866 kΩ to VREG, T _A = 25°C ⁽¹⁾	580	650	720	
		R _{RF} = 309 kΩ to VREG, T _A = 25°C ⁽¹⁾	670	750	820	
		R _{RF} = 124 kΩ to VREG, T _A = 25°C ⁽¹⁾	770	850	930	
		R _{RF} = 0 Ω to VREG, T _A = 25°C ⁽¹⁾	880	970	1070	
PROTECTION: CURRENT SENSE						
I _{TRIP}	TRIP source current	V _{TRIP} = 1 V, T _A = 25°C	9.4	10.0	10.6	μA
TC _{ITRIP}	TRIP current temperature coefficient	On the basis of 25°C ⁽²⁾		4700		ppm/°C
V _{TRIP}	Current limit threshold setting range	V _{TRIP-GND} voltage	0.2		1.2	V
V _{OCL}	Current limit threshold	V _{TRIP} = 1.2 V	140	150	160	mV
		V _{TRIP} = 0.2	19	26	33	
V _{OCLN}	Negative current limit threshold	V _{TRIP} = 1.2 V	-160	-150	-140	mV
		V _{TRIP} = 0.2 V	-33	-26	-19	
V _{AZCADJ}	Auto zero cross adjustable range	Positive	3	15		mV
		Negative		-15	-3	
PROTECTION: UVP and OVP						
V _{OVP}	OVP trip threshold	OVP detect	115%	120%	125%	
t _{OVPDEL}	OVP propagation delay time	VFB delay with 50-mV overdrive		1		μs
V _{UVP}	Output UVP trip threshold time	UVP detect	65%	70%	75%	
t _{UVPDEL}	Output UVP propagation delay time		0.8	1	1.2	ms
t _{UVPEN}	Output UVP enable delay time	from EN to UVP workable, R _{MODE} = 39 kΩ	2.0	2.6	3.2	ms
UVLO						
V _{UVVREG}	VREG UVLO threshold	Wake up	4.00	4.20	4.32	V
		Hysteresis		0.25		
THERMAL SHUTDOWN						
T _{SDN}	Thermal shutdown threshold	Shutdown temperature ⁽²⁾		145		°C
		Hysteresis ⁽²⁾		10		

 (1) Not production tested. Test condition is V_{IN} = 12 V, V_{OUT} = 1.1 V, I_{OUT} = 5 A using application circuit shown in [Figure 33](#).

(2) Ensured by design. Not production tested.

PIN DESCRIPTION

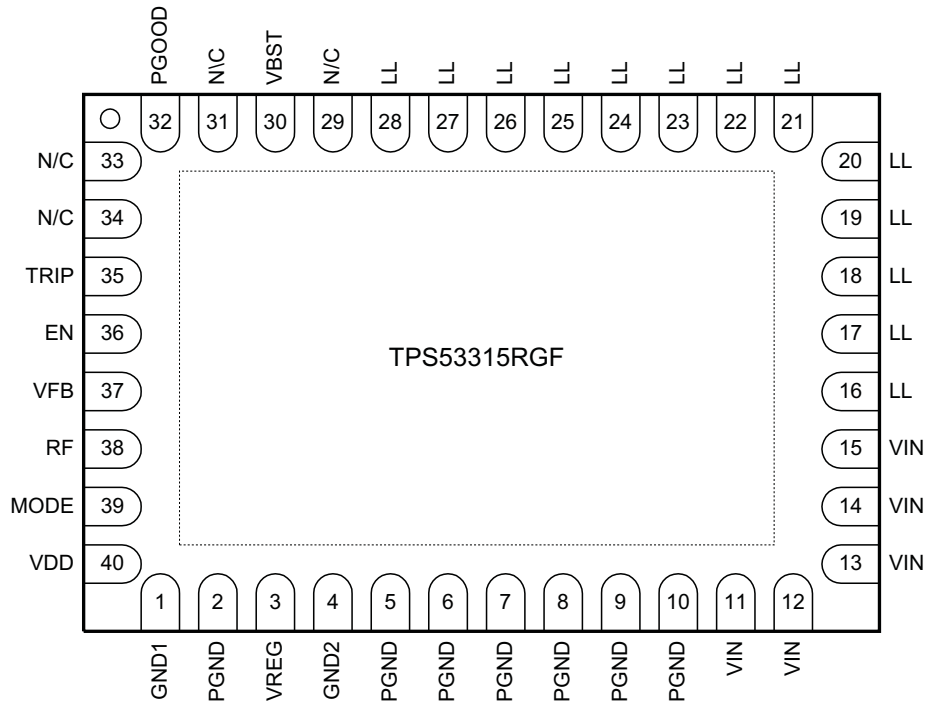

PIN FUNCTIONS

PIN		I/O/P ⁽¹⁾	DESCRIPTION
NAME	NO.		
EN	36	I	Enable pin.
GND1	1	G	GND for controller
GND2	4	G	GND for half-bridge
LL	16, 17, 18, 19, 20, 21, 22, 23, 24, 25, 26, 27, 28	B	Output of converted power. Connect this pin to the output Inductor.
MODE	39	I	Soft-start and skip/CCM selection. Connect a resistor to select soft-start time using Table 1 . The soft-start time is detected and stored into internal register during start-up.
N/C	29, 31, 33, 34		No connection

(1) I=Input, O=Output, B=Bidirectional, P=Supply, G=Ground

PIN FUNCTIONS (continued)

PIN		I/O/P ⁽¹⁾	DESCRIPTION
NAME	NO.		
PGOOD	32	O	Open drain power good flag. Provides a 1-ms start up delay after the VFB pin voltage falls within specified limits. When the VFB pin voltage goes outside the specified limits, the PGOOD pin goes low within 10 μ s.
PGND	2	G	Power GND
	5		
	6		
	7		
	8		
	9		
RF	38	I	Switching frequency selection. Connect a resistance to GND or VREG to select switching frequency using Table 2 . The switching frequency is detected and stored during the startup.
TRIP	35	I	OCL detection threshold setting pin. 10 μ A at room temperature, 4700 ppm/ $^{\circ}$ C current is sourced and set the OCL trip voltage as follows. $V_{OCL} = V_{TRIP}/8 \quad (V_{TRIP} \leq 1.2 \text{ V}, V_{OCL} \leq 150 \text{ mV})$
VBST	30	P	Supply input for high-side FET gate driver (boost terminal). Connect capacitor from this pin to LL-node. Internally connected to the VREG pin via bootstrap MOSFET switch.
VDD	40	P	Controller power supply input.
VFB	37	I	Output feedback input. Connect this pin to V_{OUT} through a resistor divider.
VIN	11	P	Conversion power input.
	12		
	13		
	14		
VREG	3	P	5-V LDO output.

FUNCTIONAL BLOCK DIAGRAM

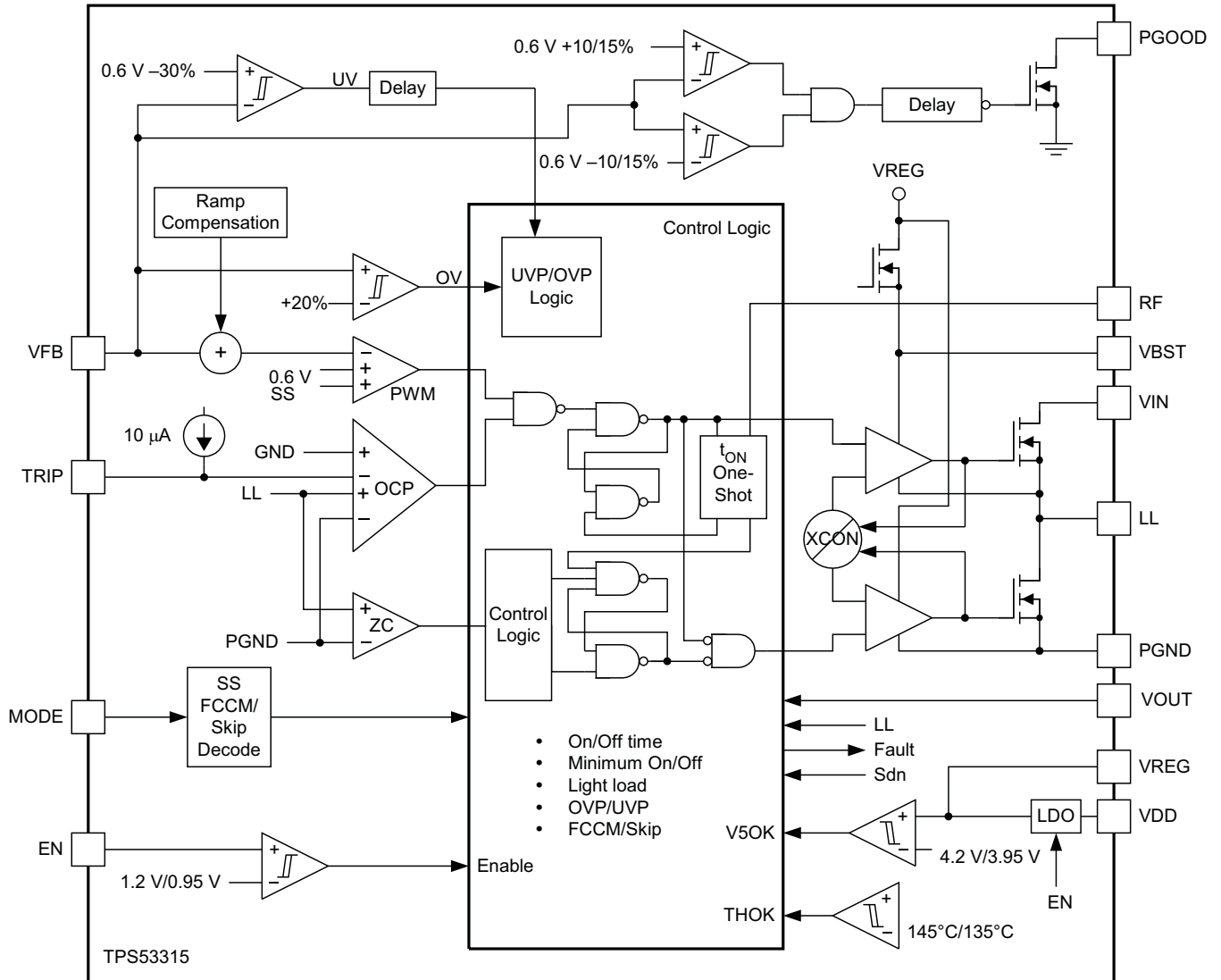

UDG-10200

TYPICAL CHARACTERISTICS

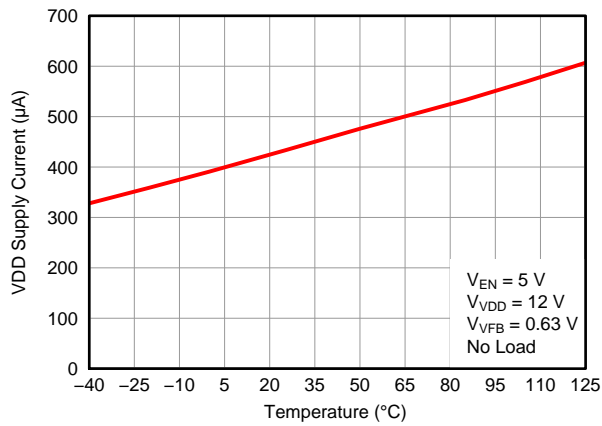

Figure 1. VDD Supply Current vs. Temperature

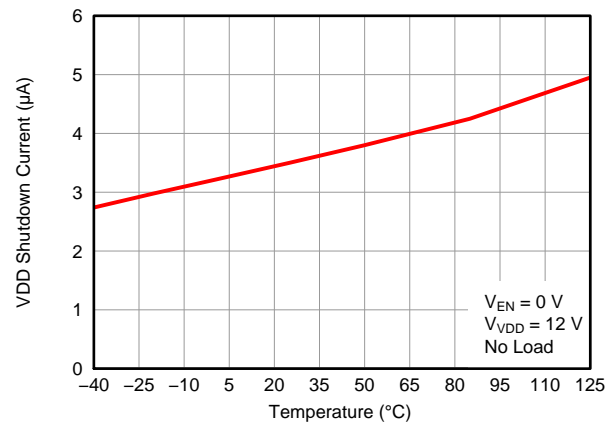

Figure 2. VDD Shutdown Current vs. Temperature

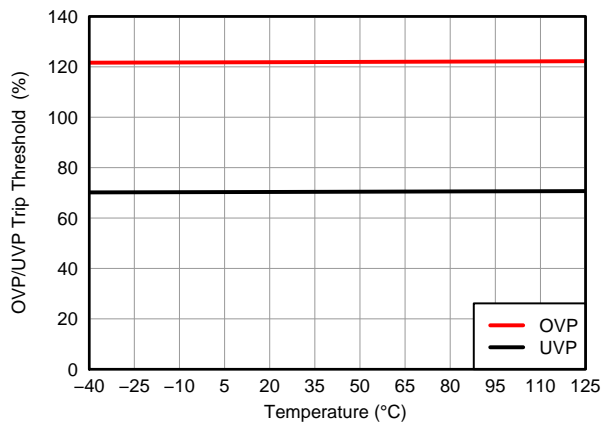

Figure 3. OVP/UVP Trip Threshold vs. Temperature

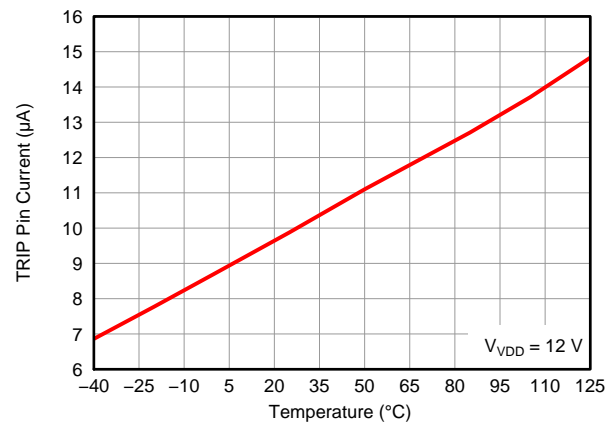

Figure 4. Trip Pin Current vs. Temperature

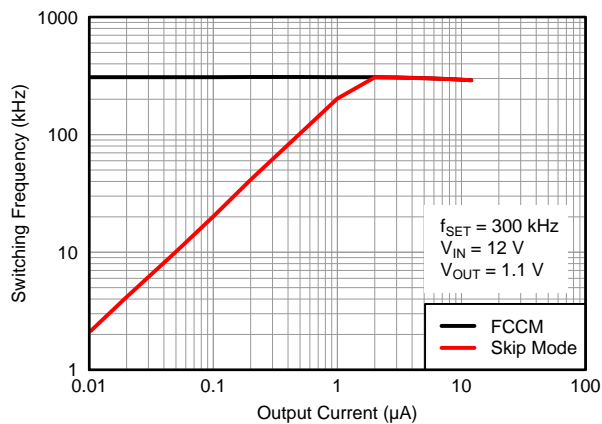

Figure 5. Frequency vs. Temperature ($f_{SET} = 300 \text{ kHz}$)

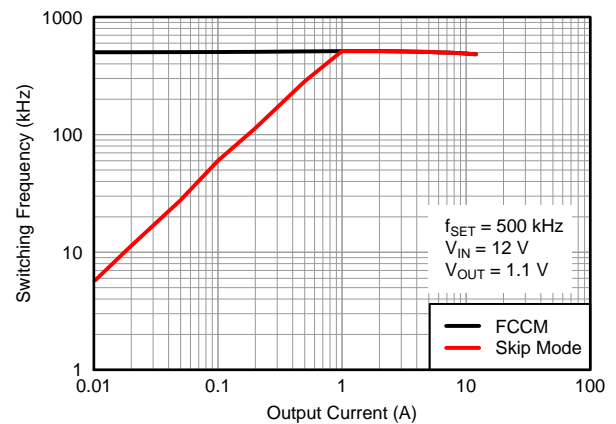

Figure 6. Frequency vs. Temperature ($f_{SET} = 500 \text{ kHz}$)

TYPICAL CHARACTERISTICS

Inductor Values
 IN06155: 1 μ H, 2.3 m Ω , HCB1175-501: 0.5 μ H, 0.29 m Ω

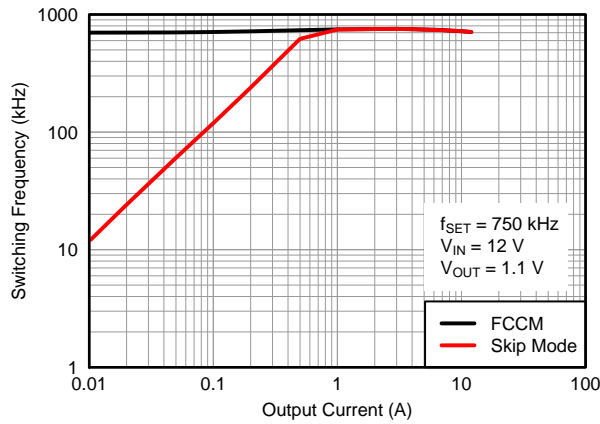

Figure 7. Frequency vs. Temperature ($f_{SET} = 750$ kHz)

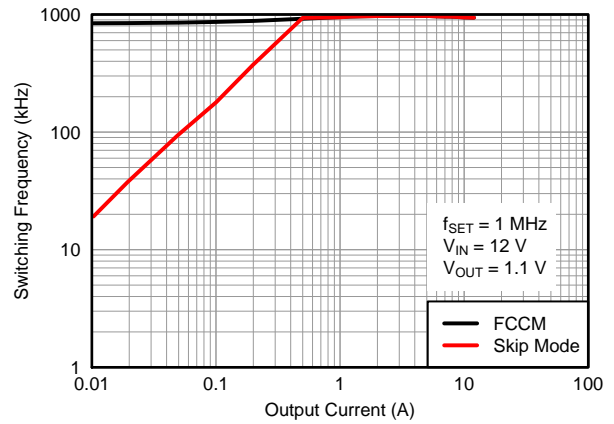

Figure 8. Frequency vs. Temperature ($f_{SET} = 1$ MHz)

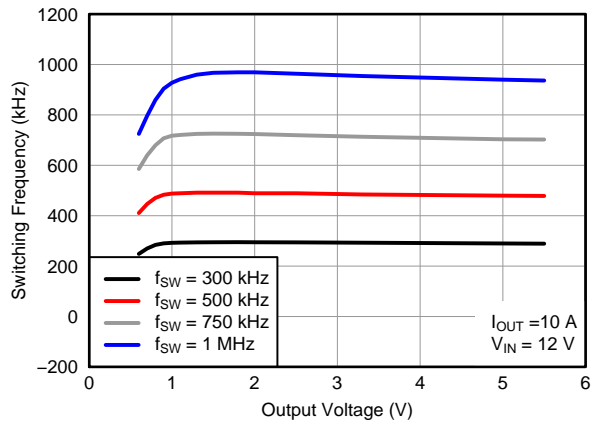

Figure 9. Switching Frequency vs. Output Voltage

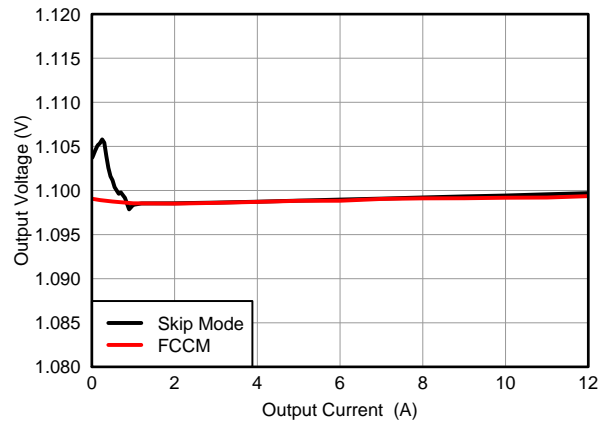

Figure 10. Output Voltage vs. Output Current

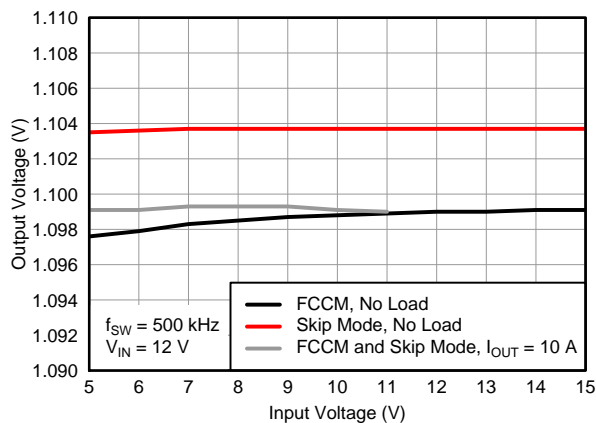

Figure 11. Output Voltage vs. Input Voltage

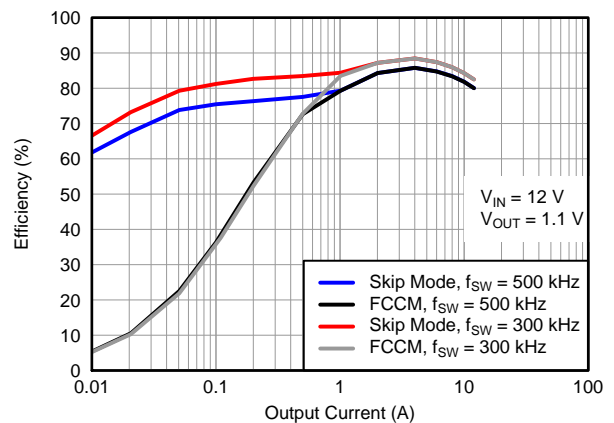

Figure 12. Efficiency vs. Output Current, Inductor: IN06155

TYPICAL CHARACTERISTICS

Inductor Values
 IN06155: 1 μ H, 2.3 m Ω , HCB1175-501: 0.5 μ H, 0.29 m Ω

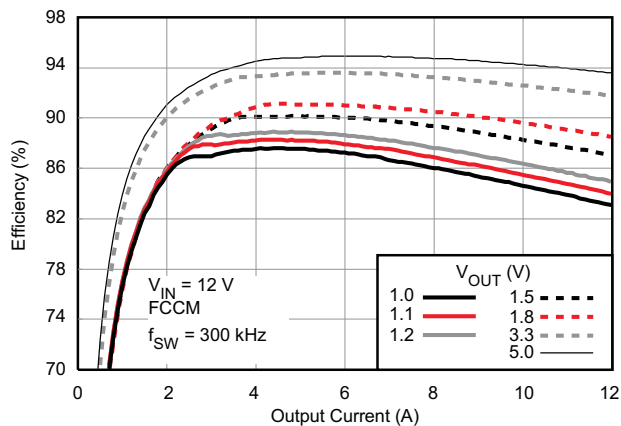

Figure 13. Efficiency vs Output Current, Inductors: $V_{OUT} \leq 1.8$ V: HCB1175-501, $V_{OUT} \geq 3.3$ V: IN06155

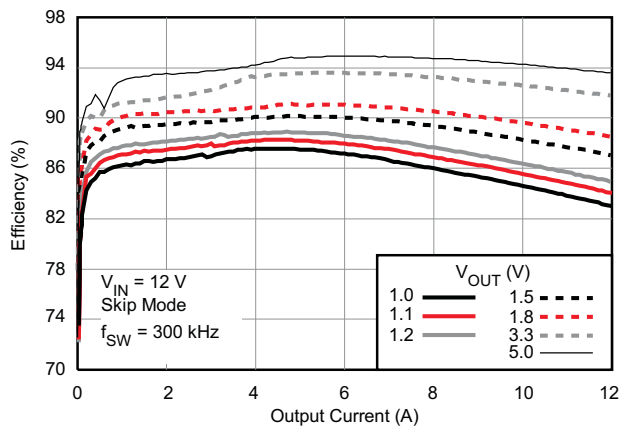

Figure 14. Efficiency vs Output Current, Inductors: $V_{OUT} \leq 1.8$ V: HCB1175-501, $V_{OUT} \geq 3.3$ V: IN06155

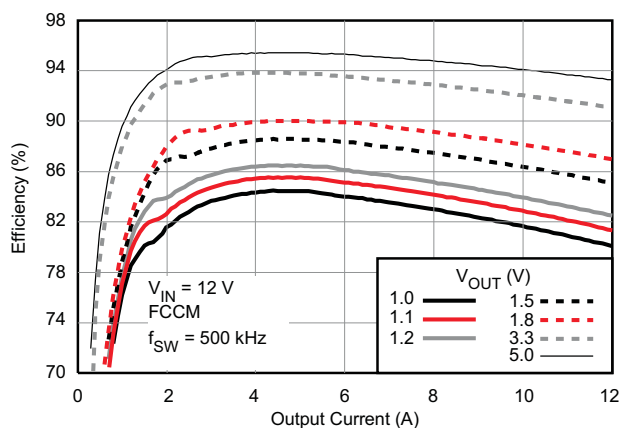

Figure 15. Efficiency vs Output Current, Inductors: $V_{OUT} \leq 1.8$ V: HCB1175-501, $V_{OUT} \geq 3.3$ V: IN06155

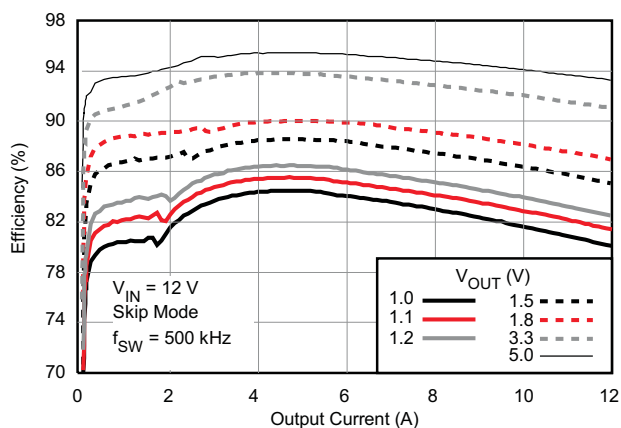

Figure 16. Efficiency vs Output Current, Inductors: $V_{OUT} \leq 1.8$ V: HCB1175-501, $V_{OUT} \geq 3.3$ V: IN06155

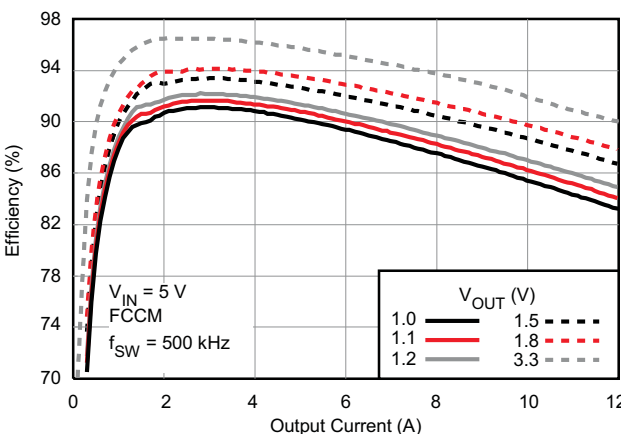

Figure 17. Efficiency vs Output Current, Inductor: HCB1175-501

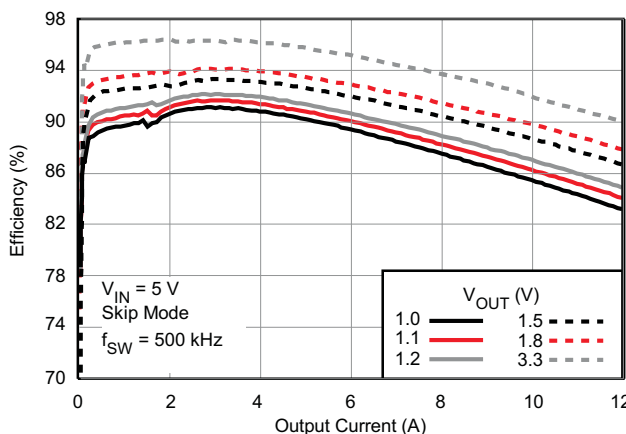
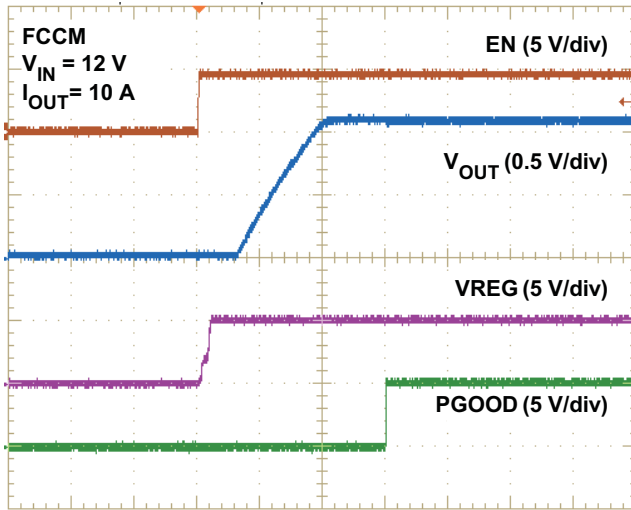

Figure 18. Efficiency vs Output Current, Inductor: HCB1175-501

TYPICAL CHARACTERISTICS



Time (1 ms/div)

Figure 19. Start-Up

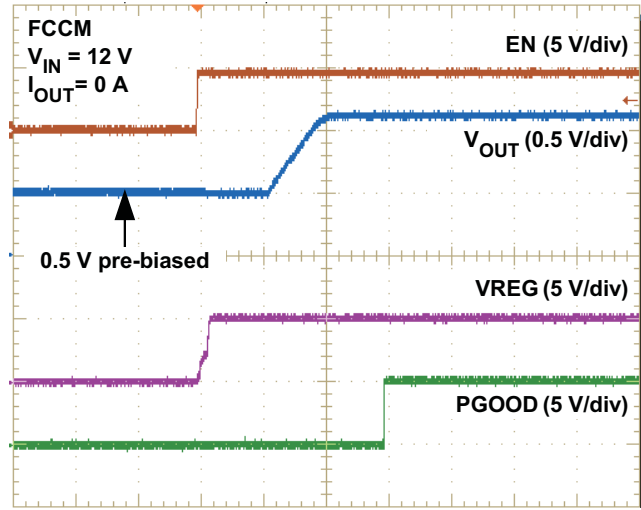

Time (1 ms/div)

Figure 20. Pre-Bias Start-Up

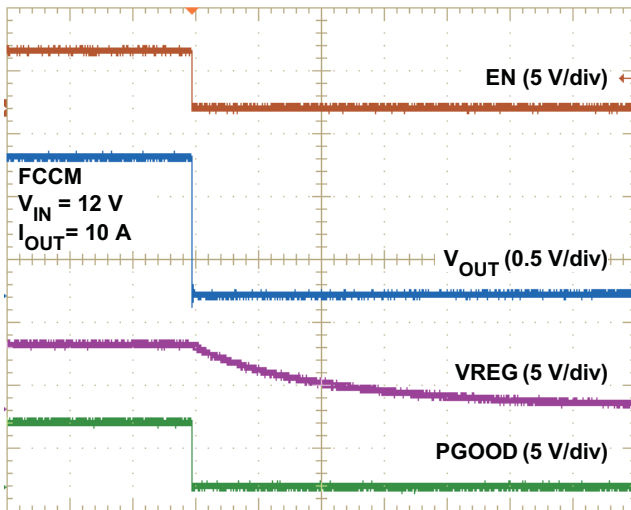

Time (4 ms/div)

Figure 21. Turn-Off

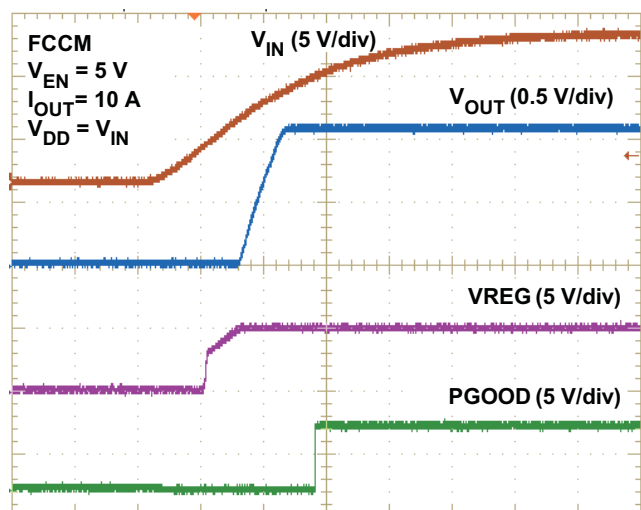

Time (2 ms/div)

Figure 22. UVLO Start-Up

TYPICAL CHARACTERISTICS

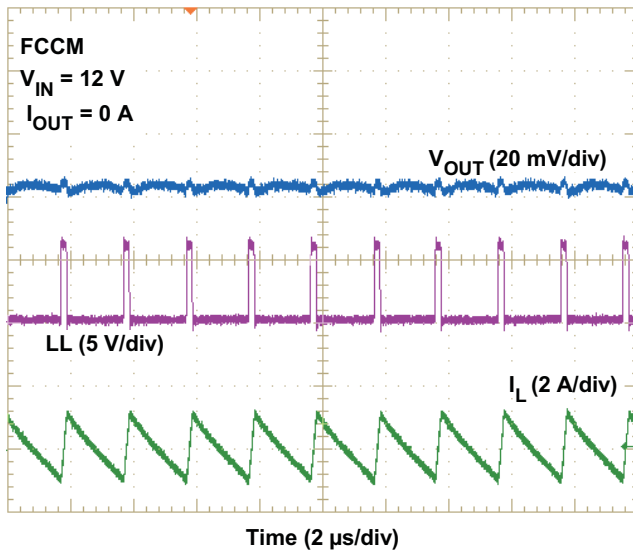

Figure 23. 1.1-V Output FFCM Steady-State Operation

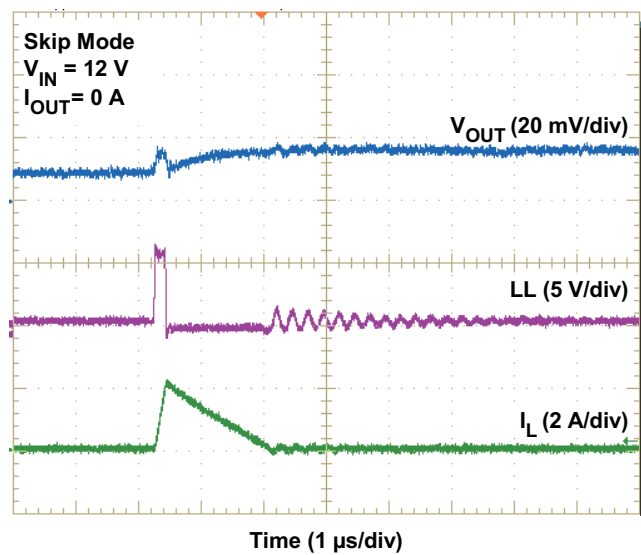

Figure 24. 1.1-V Output Skip Mode Steady-State Operation

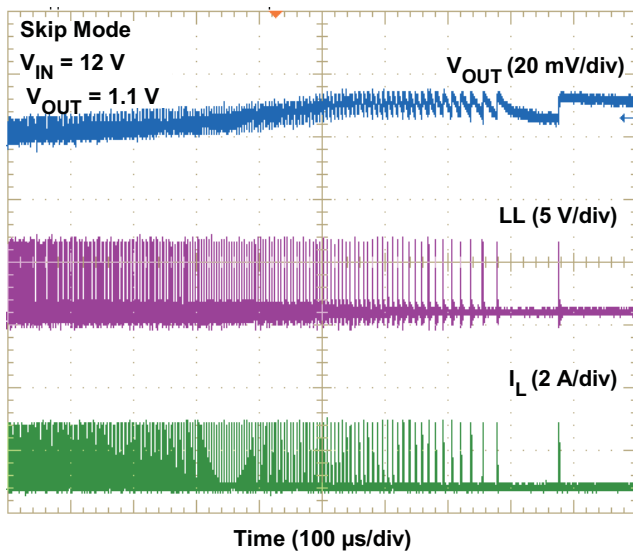

Figure 25. CCM to DCM Transition

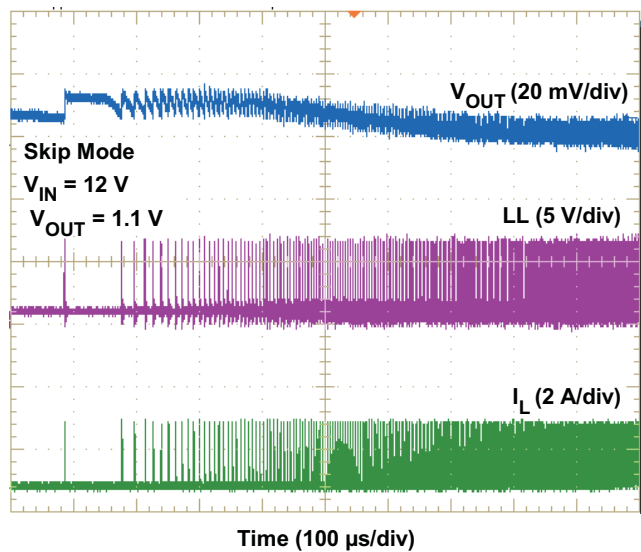

Figure 26. DCM to CCM Transition

TYPICAL CHARACTERISTICS

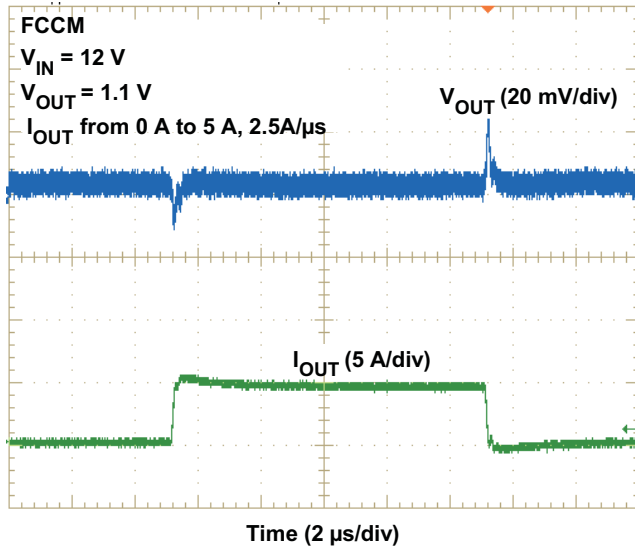

Figure 27. FCCM Load Transient

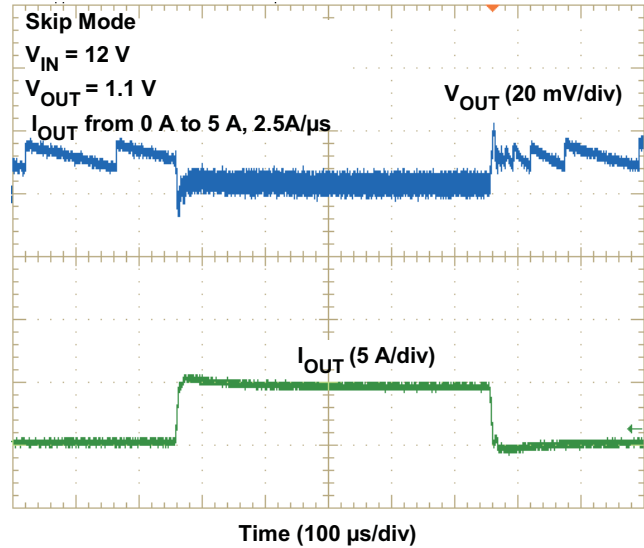

Figure 28. Skip Mode Load Transient

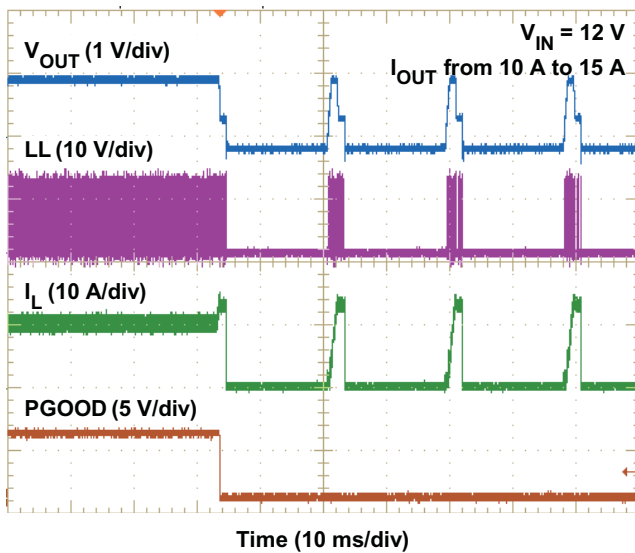

Figure 29. Overcurrent Protection

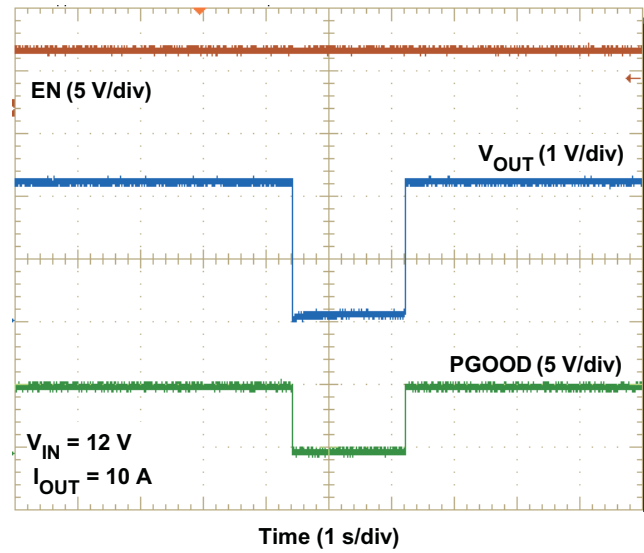

Figure 30. Over-temperature Protection

TYPICAL CHARACTERISTICS

Figure 31, shows the thermal signature of the TPS53315 EVM, $V_{IN} = 12\text{ V}$, $V_{OUT} = 1.1\text{ V}$, $I_{OUT} = 12\text{ A}$, $f_{SW} = 500\text{ kHz}$ at room temperature with no airflow.

Figure 32 shows the thermal signature of the TPS53315 EVM, $V_{IN} = 12\text{ V}$, $V_{OUT} = 3.3\text{ V}$, $I_{OUT} = 12\text{ A}$, $f_{SW} = 650\text{ kHz}$ at room temperature with no airflow.

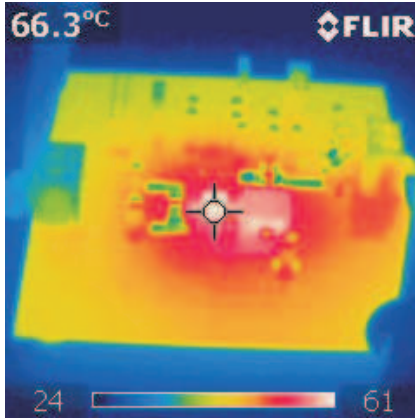

Figure 31. Thermal Signature of TPS53315 EVM,
 $f_{SW} = 500\text{ kHz}$

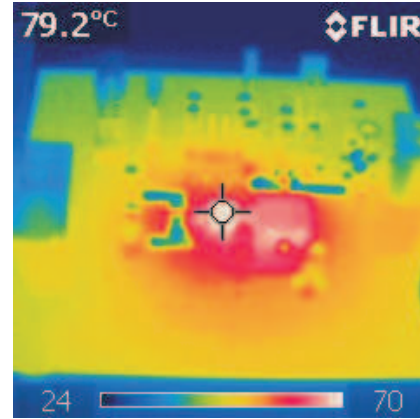
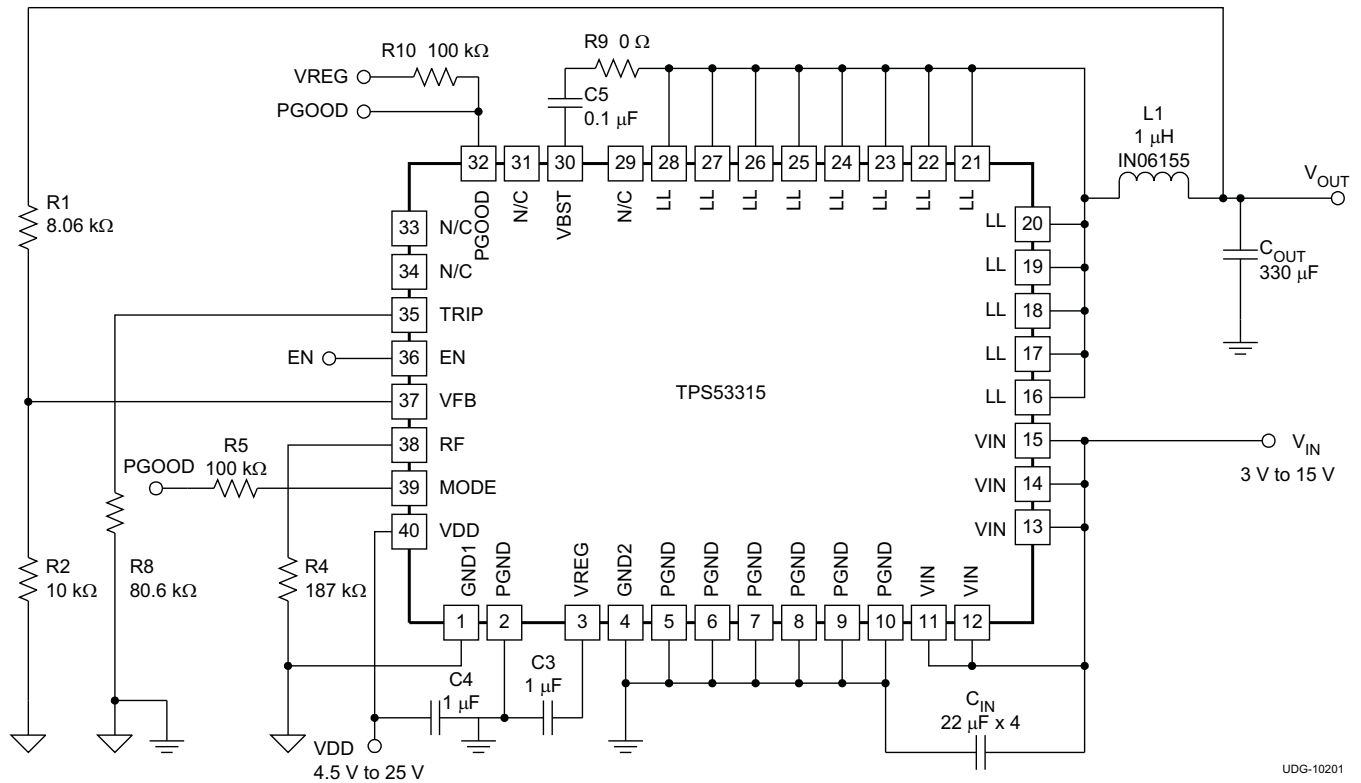

Figure 32. Thermal Signature of TPS53315 EVM,
 $f_{SW} = 650\text{ kHz}$

APPLICATION INFORMATION

APPLICATION CIRCUIT DIAGRAM



UDG-10201

Figure 33. Typical Application Circuit Diagram

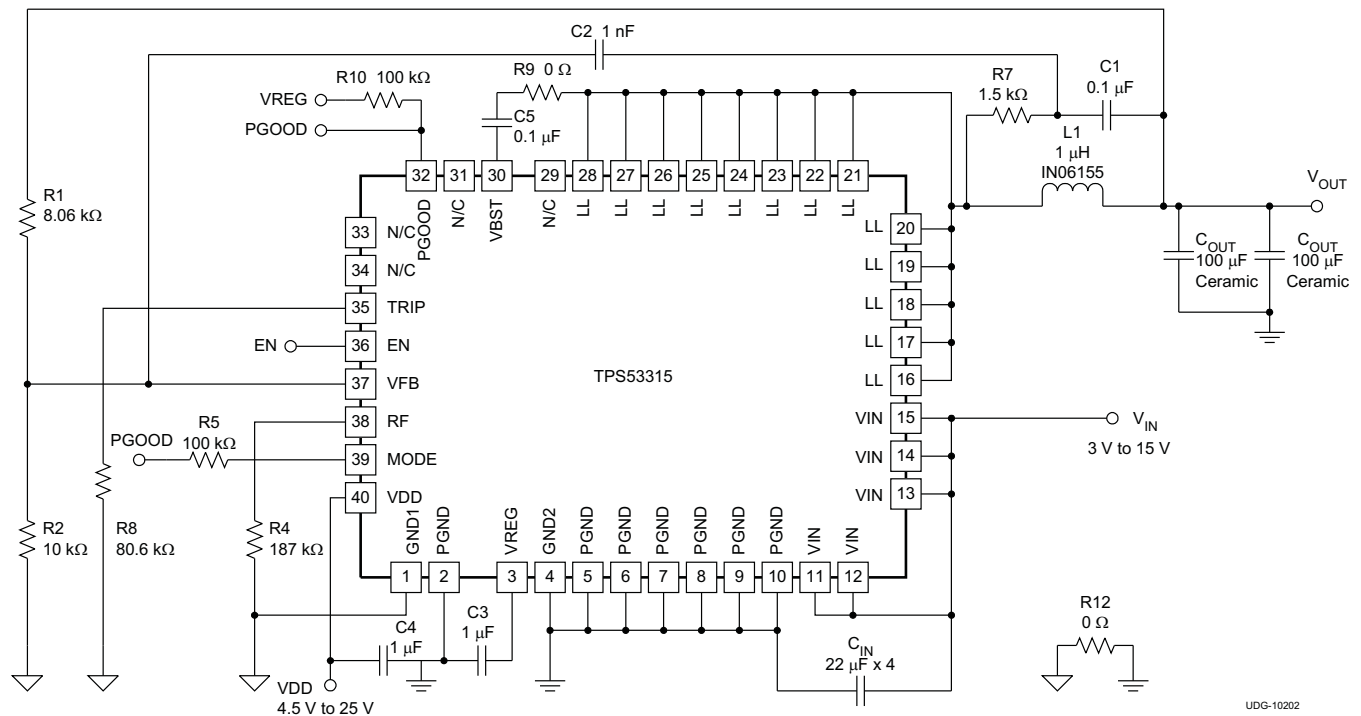

UDG-10202

Figure 34. Typical Application Circuit Diagram with Ceramic Output Capacitors

General Description

The TPS53315 is a high-efficiency, single channel, synchronous buck converter suitable for low output voltage point-of-load applications in computing and similar digital consumer applications. The device features proprietary D-CAP™ mode control combined with an adaptive on-time architecture. This combination is ideal for building modern low duty ratio, ultra-fast load step response DC-DC converters. The output voltage ranges from 0.6 V to 5.5 V. The conversion input voltage range is from 3 V up to 15 V. The D-CAP™ mode uses the ESR of the output capacitor(s) to sense the device current. One advantage of this control scheme is that it does not require an external phase compensation network. This allows a simple design with a low external component count. Eight preset switching frequency values can be chosen using a resistor connected from the RF pin to ground or the VREG pin. Adaptive on-time control tracks the preset switching frequency over a wide input and output voltage range while allowing the switching frequency to increase at the step-up of the load.

The TPS53315 has a MODE pin to select between auto-skip mode and forced continuous conduction mode (FCCM) for light load conditions. The MODE pin also sets the selectable soft-start time ranging from 0.7 ms to 5.6 ms.

Enable and Soft Start

When the EN pin voltage rises above the enable threshold voltage (typically 1.2 V), the controller enters its start-up sequence. The internal LDO regulator starts immediately and regulates to 5 V at the VREG pin. The controller then uses the first 250 μ s to calibrate the switching frequency setting resistance attached to the RF pin and stores the switching frequency code in internal registers. However, switching is inhibited during this phase. In the second phase, an internal DAC starts ramping up the reference voltage from 0 V to 0.6 V. Depending on the MODE pin setting, the ramping up time varies from 0.7 ms to 5.6 ms. Smooth and constant ramp-up of the output voltage is maintained during start-up regardless of load current.

Table 1. Soft-Start and MODE

MODE SELECTION	ACTION	SOFT-START TIME (ms)	R _{MODE} (k Ω)
Auto Skip	Pull down to GND	0.7	39
		1.4	100
		2.8	200
		5.6	475
Forced CCM ⁽¹⁾	Connect to PGOOD	0.7	39
		1.4	100
		2.8	200
		5.6	475

(1) The device transitions into FCCM after the PGOOD pin goes high.

Adaptive On-Time D-CAP™ Control

The TPS53315 does not have a dedicated oscillator to determine switching frequency. However, the device operates with pseudo-constant frequency by feed-forwarding the input and output voltages into the on-time one-shot timer. The adaptive on-time control adjusts the on-time to be inversely proportional to the input voltage

$$t_{ON} \propto \frac{V_{IN}}{V_{OUT}}$$

and proportional to the output voltage

This makes the switching frequency fairly constant in steady state conditions over a wide input voltage range. The switching frequency is selectable from eight preset values by a resistor connected between the RF pin and GND or between the RF pin and the VREG pin as shown in Table 2. (Leaving the resistance open sets the switching frequency to 500 kHz.)

Table 2. Resistor and Switching Frequency

RESISTOR (R _{RF}) CONNECTIONS	SWITCHING FREQUENCY (kHz)
0 Ω to GND	250
187 kΩ to GND	300
619 kΩ to GND	400
Open	500
866 kΩ to VREG	600
309 kΩ to VREG	750
124 kΩ to VREG	850
0 Ω to VREG	970

The off-time is modulated by a PWM comparator. The VFB node voltage (the mid-point of resistor divider) is compared to the internal 0.6-V reference voltage added with a ramp signal. When the signal values match, the PWM comparator asserts a set signal to terminate the off-time (turn off the low-side MOSFET and turn on high-side MOSFET). The set signal is valid if the inductor current level is below the OCP threshold, otherwise the off-time is extended until the current level falls below the threshold.

Figure 35 and Figure 36 show two on-time control schemes.

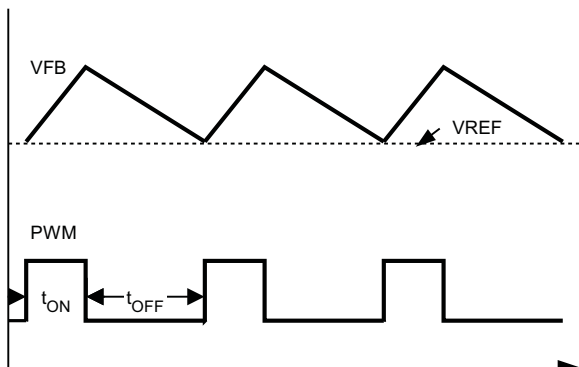

UDG-10208

Figure 35. On-Time Control Without Ramp Compensation

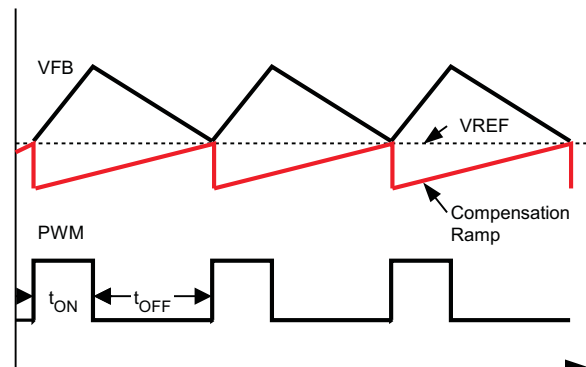

UDG-10209

Figure 36. On-Time Control With Ramp Compensation

Small Signal Model

From small-signal loop analysis, a buck converter using D-CAP™ mode can be simplified as shown in [Figure 37](#).

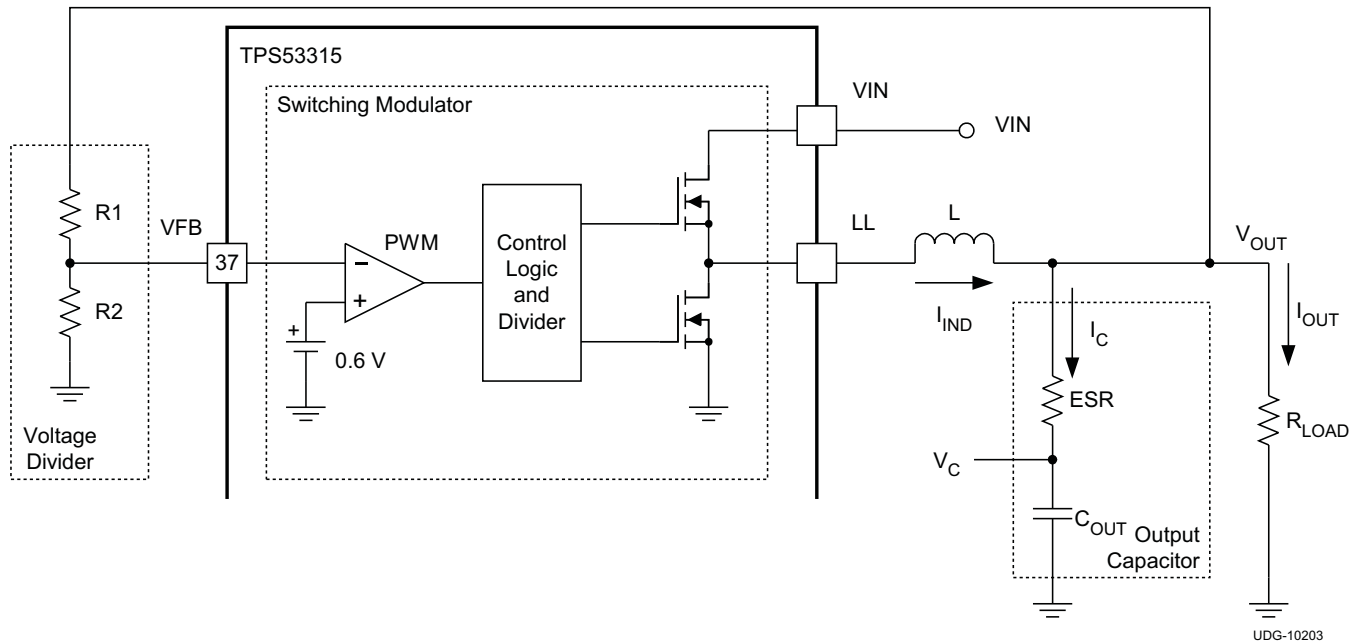

Figure 37. Simplified Modulator Model

The output voltage is compared with the internal reference voltage (ramp signal is ignored here for simplicity). The PWM comparator determines the timing to turn on the high-side MOSFET. The gain and speed of the comparator can be assumed high enough to keep the voltage at the beginning of each on-cycle substantially constant.

$$H(s) = \frac{1}{s \times \text{ESR} \times C_{\text{OUT}}} \quad (1)$$

For the loop stability, the 0 dB frequency, f_0 , defined in [Equation 2](#) must be lower than $\frac{1}{4}$ of the switching frequency.

$$f_0 = \frac{1}{2\pi \times \text{ESR} \times C_{\text{OUT}}} \leq \frac{f_{\text{SW}}}{4} \quad (2)$$

According to [Equation 2](#), the loop stability of D-CAP™ mode modulator is mainly determined by the capacitor chemistry. For example, specialty polymer capacitors (SP-CAP) have C_{OUT} on the order of several 100 μF and ESR in range of 10 m Ω . These makes f_0 on the order of 100 kHz or less and the loop is stable. However, ceramic capacitors have an f_0 at more than 700 kHz, and need special care when used with this modulator. An application circuit using ceramic capacitors is described in [External Parts Selection](#) section under *All Ceramic Output Capacitors*.

Ramp Signal

The TPS53315 adds a ramp signal to the 0.6-V reference in order to improve jitter performance. The feedback voltage is compared with the reference information to keep the output voltage in regulation. By adding a small ramp signal to the reference, the signal-to-noise ratio at the onset of a new switching cycle is improved. Therefore the operation becomes less jittery and more stable. The ramp signal is controlled to start with -7 mV at the beginning of an on-cycle and becomes 0 mV at the end of an off-cycle in steady state.

Auto-Skip Eco-mode™ Light Load Operation

While the MODE pin is pulled low via R_{MODE} , the TPS53315 automatically reduces the switching frequency at light-load conditions to maintain high efficiency. Detailed operation is described as follows. As the output current decreases from heavy load condition, the inductor current is also reduced and eventually comes to the point that its rippled valley touches zero level, which is the boundary between continuous conduction and discontinuous conduction modes. The synchronous MOSFET is turned off when this zero inductor current is detected. As the load current further decreases, the converter runs into discontinuous conduction mode (DCM). The on-time is maintained as it was in the continuous conduction mode so that it takes longer time to discharge the output capacitor with smaller load current to the level of the reference voltage. The transition point to the light-load operation $I_{OUT(LL)}$ (i.e., the threshold between continuous and discontinuous conduction mode) can be calculated as shown in [Equation 3](#).

$$I_{OUT(LL)} = \frac{1}{2 \times L \times f_{SW}} \times \frac{(V_{IN} - V_{OUT}) \times V_{OUT}}{V_{IN}}$$

where

- f_{SW} is the PWM switching frequency (3)

Switching frequency versus output current in the light load condition is a function of L , V_{IN} and V_{OUT} , but it decreases almost proportionally to the output current from the $I_{OUT(LL)}$ given in [Equation 3](#). For example, it is 60 kHz at $I_{OUT(LL)}/5$ if the frequency setting is 300 kHz.

Adaptive Zero Crossing

The TPS53315 has an adaptive zero crossing circuit which performs optimization of the zero inductor current detection at skip mode operation. This function pursues ideal low-side MOSFET turning off timing and compensates inherent offset voltage of the Z-C comparator and delay time of the Z-C detection circuit. It prevents SW-node swing-up caused by postponed detection and minimizes diode conduction period caused by premature detection. As a result, better light-load efficiency is delivered.

Forced Continuous Conduction Mode

When the MODE pin is tied to PGOOD through a resistor, the controller keeps continuous conduction mode (CCM) during light-load conditions. In this mode, the switching frequency is maintained over the entire load range which is suitable for applications needing tight control of the switching frequency at a cost of lower efficiency.

Power Good

The TPS53315 has powergood output that indicates high when switcher output is within the target. The powergood function is activated after soft-start has finished. If the output voltage becomes within +10% or –5% of the target value, internal comparators detect the powergood state and the powergood signal becomes high after a 1-ms internal delay. If the output voltage goes outside of +15% or –10% of the target value, the power-good signal becomes low after two microsecond (2- μ s) internal delay. The powergood output is an open drain output and must be pulled up externally.

In order for the PGOOD logic to be valid, the VDD input must be higher than 1 V. To avoid invalid PGOOD logic before the TPS53315 is powered up, it is recommended the PGOOD be pull to VREG (either directly or through a resistor divider) because VREG remains low when the device is off.

Current Sense and Overcurrent Protection

TPS53315 has cycle-by-cycle overcurrent limiting control. The inductor current is monitored during the *OFF* state and the controller maintains the *OFF* state during the period in that the inductor current is larger than the overcurrent trip level. In order to provide both good accuracy and cost effective solution, TPS53315 supports temperature compensated MOSFET $R_{DS(on)}$ sensing. The TRIP pin should be connected to GND through the trip voltage setting resistor, R_{TRIP} . The TRIP pin sources I_{TRIP} current, which is 10 μ A typically at room temperature, and the trip level is set to the OCL trip voltage V_{TRIP} as shown in [Equation 4](#).

$$V_{TRIP} \text{ (mV)} = R_{TRIP} \text{ (k}\Omega) \times I_{TRIP} \text{ (}\mu\text{A)} \quad (4)$$

The inductor current is monitored by the voltage between the GND pin and the SW pin so that the SW pin should be connected to the drain terminal of the low-side MOSFET properly. I_{TRIP} has 4700 ppm/°C temperature slope to compensate the temperature dependency of the $R_{DS(on)}$. The GND pin is used as the positive current sensing node. The GND pin should be connected to the proper current sensing device, (for example, the source terminal of the low-side MOSFET.)

As the comparison is done during the *OFF* state, V_{TRIP} sets the valley level of the inductor current. Thus, the load current at the overcurrent threshold, I_{OCP} , can be calculated as shown in [Equation 5](#).

$$I_{OCP} = \frac{V_{TRIP}}{(8 \times R_{DS(on)})} + \frac{I_{IND(ripple)}}{2} = \frac{V_{TRIP}}{(8 \times R_{DS(on)})} + \frac{1}{2 \times L \times f_{SW}} \times \frac{(V_{IN} - V_{OUT}) \times V_{OUT}}{V_{IN}} \quad (5)$$

In an overcurrent condition, the current to the load exceeds the current to the output capacitor, therefore the output voltage tends to decrease. Eventually, it crosses the undervoltage protection threshold and shuts down. After a hiccup delay (16 ms with 0.7-ms sort-start), the controller restarts. If the overcurrent condition remains, the procedure is repeated and the device enters hiccup mode.

During CCM, the negative current limit (NCL) protects the internal FET from carrying too much current. The NCL detect threshold is set as the same absolute value as positive OCL but negative polarity. Note that the threshold continues to represent the valley value of the inductor current.

Overvoltage and Undervoltage Protection

The TPS53315 monitors a resistor divided feedback voltage to detect overvoltage and undervoltage. When the feedback voltage becomes lower than 70% of the target voltage, the UVP comparator output goes high and an internal UVP delay counter begins counting. After 1 ms, TPS53315 latches OFF both high-side and low-side MOSFETs drivers. The controller restarts after a hiccup delay (16 ms with 0.7-ms soft-start). This function is enabled 1.5 ms after the soft-start is completed.

When the feedback voltage becomes higher than 120% of the target voltage, the OVP comparator output goes high and the circuit latches OFF the high-side MOSFET driver and latches ON the low-side MOSFET driver. The output voltage decreases. If the output voltage reaches the UV threshold, then both high-side MOSFET and low-side MOSFET driver is OFF and the device restarts after a hiccup delay. If the OV condition remains, both high-side MOSFET and low-side MOSFET driver remains OFF until the OV condition is removed.

UVLO Protection

The TPS53315 uses VREG undervoltage lockout protection (UVLO). When the VREG voltage is lower than the UVLO threshold voltage, the switch mode power supply shuts off. This is a non-latch protection.

Thermal Shutdown

TPS53315 includes a temperature monitoring feature. If the temperature exceeds the threshold value (typically 145°C), TPS53315 shuts off. When the temperature falls approximately 10°C below the threshold value, the device turns on again. This is a non-latch protection.

External Parts Selection

The external components selection is a simple process using D-CAP™ Mode.

1. CHOOSE THE INDUCTOR

The inductance value should be determined to give the ripple current of approximately 1/4 to 1/2 of maximum output current. Larger ripple current increases output ripple voltage and improves signal-to-noise ratio and helps stable operation.

$$L = \frac{1}{I_{\text{IND(ripple)}} \times f_{\text{SW}}} \times \frac{(V_{\text{IN(max)}} - V_{\text{OUT}}) \times V_{\text{OUT}}}{V_{\text{IN(max)}}} = \frac{3}{I_{\text{OUT(max)}} \times f_{\text{SW}}} \times \frac{(V_{\text{IN(max)}} - V_{\text{OUT}}) \times V_{\text{OUT}}}{V_{\text{IN(max)}}} \quad (6)$$

The inductor requires a low DCR to achieve good efficiency. It also requires enough room above peak inductor current before saturation. The peak inductor current can be estimated in [Equation 7](#).

$$I_{\text{IND(peak)}} = \frac{V_{\text{TRIP}}}{8 \times R_{\text{DS(on)}}} + \frac{1}{L \times f_{\text{SW}}} \times \frac{(V_{\text{IN(max)}} - V_{\text{OUT}}) \times V_{\text{OUT}}}{V_{\text{IN(max)}}} \quad (7)$$

2. CHOOSE THE OUTPUT CAPACITOR(S)

When organic semiconductor capacitor(s) or specialty polymer capacitor(s) are used, for loop stability, capacitance and ESR should satisfy [Equation 2](#). For jitter performance, [Equation 8](#) is a good starting point to determine ESR.

$$\text{ESR} = \frac{V_{\text{OUT}} \times 10(\text{mV}) \times (1-D)}{0.6(\text{V}) \times I_{\text{IND(ripple)}}} = \frac{10(\text{mV}) \times L \times f_{\text{SW}}}{0.6(\text{V})} = \frac{L \times f_{\text{SW}}}{60} (\Omega)$$

where

- D is the duty factor
- t_{SW} is the switching period
- the required output ripple slope is approximately 20 mV per t_{SW} in terms of V_{VFB}

3. DETERMINE THE VALUE OF R1 AND R2

The output voltage is programmed by the voltage-divider resistor, R1 and R2 shown in [Figure 37](#). R1 is connected between VFB pin and the output, and R2 is connected between the VFB pin and GND. Recommended R2 value is from 10kΩ to 20kΩ. Determine R1 using [Equation 9](#).

$$R1 = \frac{V_{\text{OUT}} - \frac{I_{\text{IND(ripple)}} \times \text{ESR}}{2} - 0.6}{0.6} \times R2 \quad (9)$$

External Parts Selection with All Ceramic Output Capacitors

When ceramic output capacitors are used, the stability criteria in [Equation 2](#) cannot be satisfied. The ripple injection approach as shown in [Equation 10](#) is implemented to increase the ripple on the VFB pin and make the system stable. C2 can be fixed at 1 nF. The value of C1 can be selected between 10 nF to 200 nF.

The increased ripple on the VFB pin causes the increase of the VFB DC value. The AC ripple coupled to the VFB pin has two components, one coupled from SW node and the other coupled from V_{OUT} and they can be calculated using [Equation 10](#) and [Equation 11](#).

$$V_{INJ_SW} = \frac{V_{IN} - V_{OUT}}{R7 \times C1} \times \frac{D}{f_{SW}} \quad (10)$$

$$V_{INJ_OUT} = ESR \times I_{IND(ripple)} + \frac{I_{IND(ripple)}}{8 \times C_{OUT} \times f_{SW}} \quad (11)$$

The DC value of VFB can be calculated by [Equation 12](#):

$$V_{VFB} = 0.6 + \frac{V_{INJ_SW} + V_{INJ_OUT}}{2} \quad (12)$$

And the resistor divider value can be determined by [Equation 13](#):

$$R1 = \frac{V_{OUT} - V_{FB}}{V_{FB}} \times R2 \quad (13)$$

LAYOUT CONSIDERATIONS

Certain points must be considered before starting a layout work using the TPS53315.

- The power components (including input/output capacitors, inductor and TPS53315) should be placed on one side of the PCB (solder side). Other small signal components should be placed on another side (component side). At least one inner plane should be inserted, connected to ground, in order to shield and isolate the small signal traces from noisy power lines.
- All sensitive analog traces and components such as VFB, PGOOD, TRIP, MODE and RF should be placed away from high-voltage switching nodes such as LL, VBST to avoid coupling. Use internal layer(s) as ground plane(s) and shield feedback trace from power traces and components.
- Place the VIN decoupling capacitors as close to the VIN and PGND pins as possible to minimize the input AC current loop.
- Since the TPS53315 controls output voltage referring to voltage across the V_{OUT} capacitor, the top-side resistor of the voltage divider should be connected to the positive node of V_{OUT} capacitor. In a same manner both bottom side resistor and GND pad of the device should be connected to the negative node of V_{OUT} capacitor. The trace from these resistors to the VFB pin should be short and thin. Place on the component side and avoid via(s) between these resistors and the device.
- Connect the overcurrent setting resistors from TRIP pin to ground and make the connections as close as possible to the device. The trace from TRIP pin to resistor and from resistor to ground should avoid coupling to a high-voltage switching node.
- Connect the frequency setting resistor from RF pin to ground, or to the VREG pin, and make the connections as close as possible to the device. The trace from the RF pin to the resistor and from the resistor to ground should avoid coupling to a high-voltage switching node.
- Connect the MODE setting resistor from MODE pin to ground, or to the PGOOD pin, and make the connections as close as possible to the device. The trace from the MODE pin to the resistor and from the resistor to ground should avoid coupling to a high-voltage switching node.
- The PCB trace defined as switch node, which connects the LL pins and high-voltage side of the inductor, should be as short and wide as possible.

PACKAGING INFORMATION

Orderable Device	Status (1)	Package Type	Package Drawing	Pins	Package Qty	Eco Plan (2)	Lead/Ball Finish	MSL Peak Temp (3)	Op Temp (°C)	Top-Side Markings (4)	Samples
TPS53315RGFR	ACTIVE	VQFN	RGF	40	3000	Green (RoHS & no Sb/Br)	CU NIPDAU	Level-2-260C-1 YEAR	-40 to 85	TPS 53315	Samples
TPS53315RGFT	ACTIVE	VQFN	RGF	40	250	Green (RoHS & no Sb/Br)	CU NIPDAU	Level-2-260C-1 YEAR	-40 to 85	TPS 53315	Samples

(1) The marketing status values are defined as follows:

ACTIVE: Product device recommended for new designs.

LIFEBUY: TI has announced that the device will be discontinued, and a lifetime-buy period is in effect.

NRND: Not recommended for new designs. Device is in production to support existing customers, but TI does not recommend using this part in a new design.

PREVIEW: Device has been announced but is not in production. Samples may or may not be available.

OBSOLETE: TI has discontinued the production of the device.

(2) Eco Plan - The planned eco-friendly classification: Pb-Free (RoHS), Pb-Free (RoHS Exempt), or Green (RoHS & no Sb/Br) - please check <http://www.ti.com/productcontent> for the latest availability information and additional product content details.

TBD: The Pb-Free/Green conversion plan has not been defined.

Pb-Free (RoHS): TI's terms "Lead-Free" or "Pb-Free" mean semiconductor products that are compatible with the current RoHS requirements for all 6 substances, including the requirement that lead not exceed 0.1% by weight in homogeneous materials. Where designed to be soldered at high temperatures, TI Pb-Free products are suitable for use in specified lead-free processes.

Pb-Free (RoHS Exempt): This component has a RoHS exemption for either 1) lead-based flip-chip solder bumps used between the die and package, or 2) lead-based die adhesive used between the die and leadframe. The component is otherwise considered Pb-Free (RoHS compatible) as defined above.

Green (RoHS & no Sb/Br): TI defines "Green" to mean Pb-Free (RoHS compatible), and free of Bromine (Br) and Antimony (Sb) based flame retardants (Br or Sb do not exceed 0.1% by weight in homogeneous material)

(3) MSL, Peak Temp. -- The Moisture Sensitivity Level rating according to the JEDEC industry standard classifications, and peak solder temperature.

(4) Multiple Top-Side Markings will be inside parentheses. Only one Top-Side Marking contained in parentheses and separated by a "~" will appear on a device. If a line is indented then it is a continuation of the previous line and the two combined represent the entire Top-Side Marking for that device.

Important Information and Disclaimer: The information provided on this page represents TI's knowledge and belief as of the date that it is provided. TI bases its knowledge and belief on information provided by third parties, and makes no representation or warranty as to the accuracy of such information. Efforts are underway to better integrate information from third parties. TI has taken and continues to take reasonable steps to provide representative and accurate information but may not have conducted destructive testing or chemical analysis on incoming materials and chemicals. TI and TI suppliers consider certain information to be proprietary, and thus CAS numbers and other limited information may not be available for release.

In no event shall TI's liability arising out of such information exceed the total purchase price of the TI part(s) at issue in this document sold by TI to Customer on an annual basis.

TAPE AND REEL INFORMATION

QUADRANT ASSIGNMENTS FOR PIN 1 ORIENTATION IN TAPE

*All dimensions are nominal

Device	Package Type	Package Drawing	Pins	SPQ	Reel Diameter (mm)	Reel Width W1 (mm)	A0 (mm)	B0 (mm)	K0 (mm)	P1 (mm)	W (mm)	Pin1 Quadrant
TPS53315RGFR	VQFN	RGF	40	3000	330.0	16.4	5.25	7.25	1.45	8.0	16.0	Q1
TPS53315RGFT	VQFN	RGF	40	250	180.0	16.4	5.25	7.25	1.45	8.0	16.0	Q1

TAPE AND REEL BOX DIMENSIONS

*All dimensions are nominal

Device	Package Type	Package Drawing	Pins	SPQ	Length (mm)	Width (mm)	Height (mm)
TPS53315RGFR	VQFN	RGF	40	3000	367.0	367.0	38.0
TPS53315RGFT	VQFN	RGF	40	250	210.0	185.0	35.0

RGF (R-PVQFN-N40)

PLASTIC QUAD FLATPACK NO-LEAD

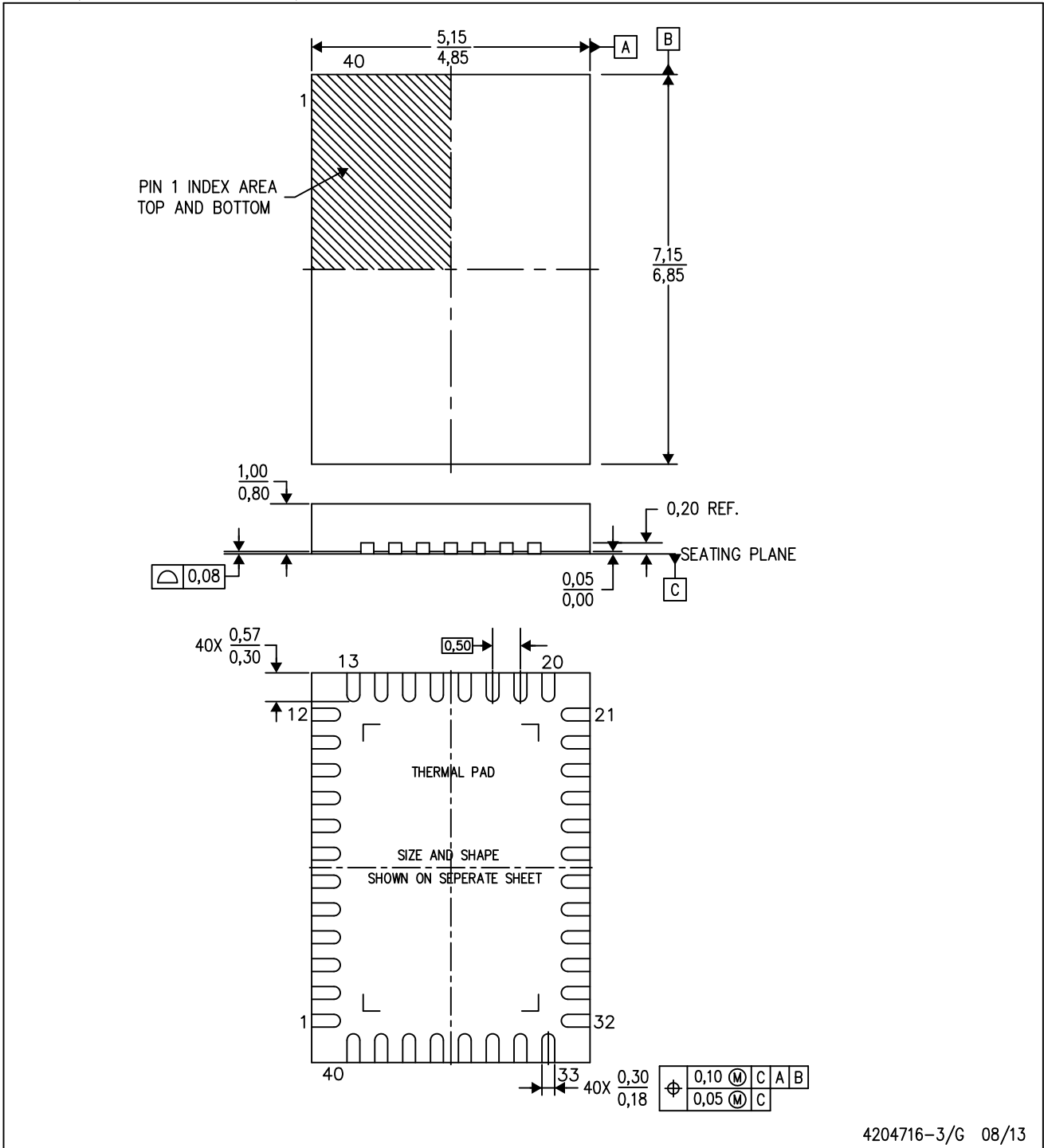

4204716-3/G 08/13

- NOTES:
- A. All linear dimensions are in millimeters. Dimensioning and tolerancing per ASME Y14.5-1994.
 - B. This drawing is subject to change without notice.
 - C. Quad Flatpack, No-leads (QFN) package configuration.
 - D. The package thermal pad must be soldered to the board for thermal and mechanical performance.
 - E. See the additional figure in the Product Data Sheet for details regarding lands and the exposed thermal pad features and dimensions.
 - F. Falls within JEDEC MO-220.

THERMAL PAD MECHANICAL DATA

RGF (R-PVQFN-N40)

PLASTIC QUAD FLATPACK NO-LEAD

THERMAL INFORMATION

This package incorporates an exposed thermal pad that is designed to be attached directly to an external heatsink. The thermal pad must be soldered directly to the printed circuit board (PCB). After soldering, the PCB can be used as a heatsink. In addition, through the use of thermal vias, the thermal pad can be attached directly to the appropriate copper plane shown in the electrical schematic for the device, or alternatively, can be attached to a special heatsink structure designed into the PCB. This design optimizes the heat transfer from the integrated circuit (IC).

For information on the Quad Flatpack No-Lead (QFN) package and its advantages, refer to Application Report, QFN/SON PCB Attachment, Texas Instruments Literature No. SLUA271. This document is available at www.ti.com.

The exposed thermal pad dimensions for this package are shown in the following illustration.

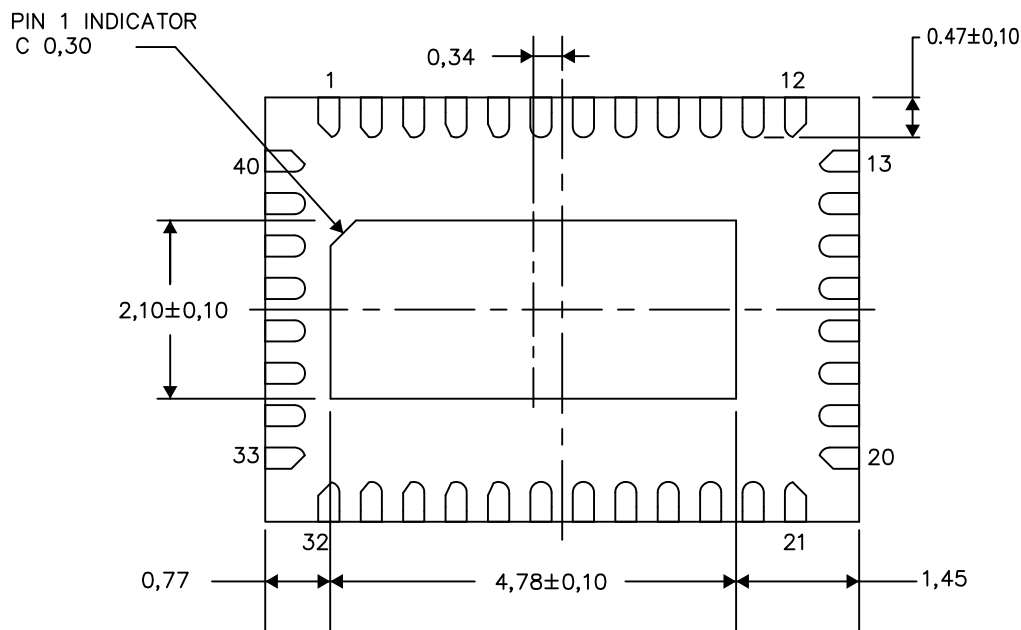

Bottom View

Exposed Thermal Pad Dimensions

4206345-7/N 01/14

NOTE: A. All linear dimensions are in millimeters

RGF (R-PVQFN-N40)

PLASTIC QUAD FLATPACK NO-LEAD

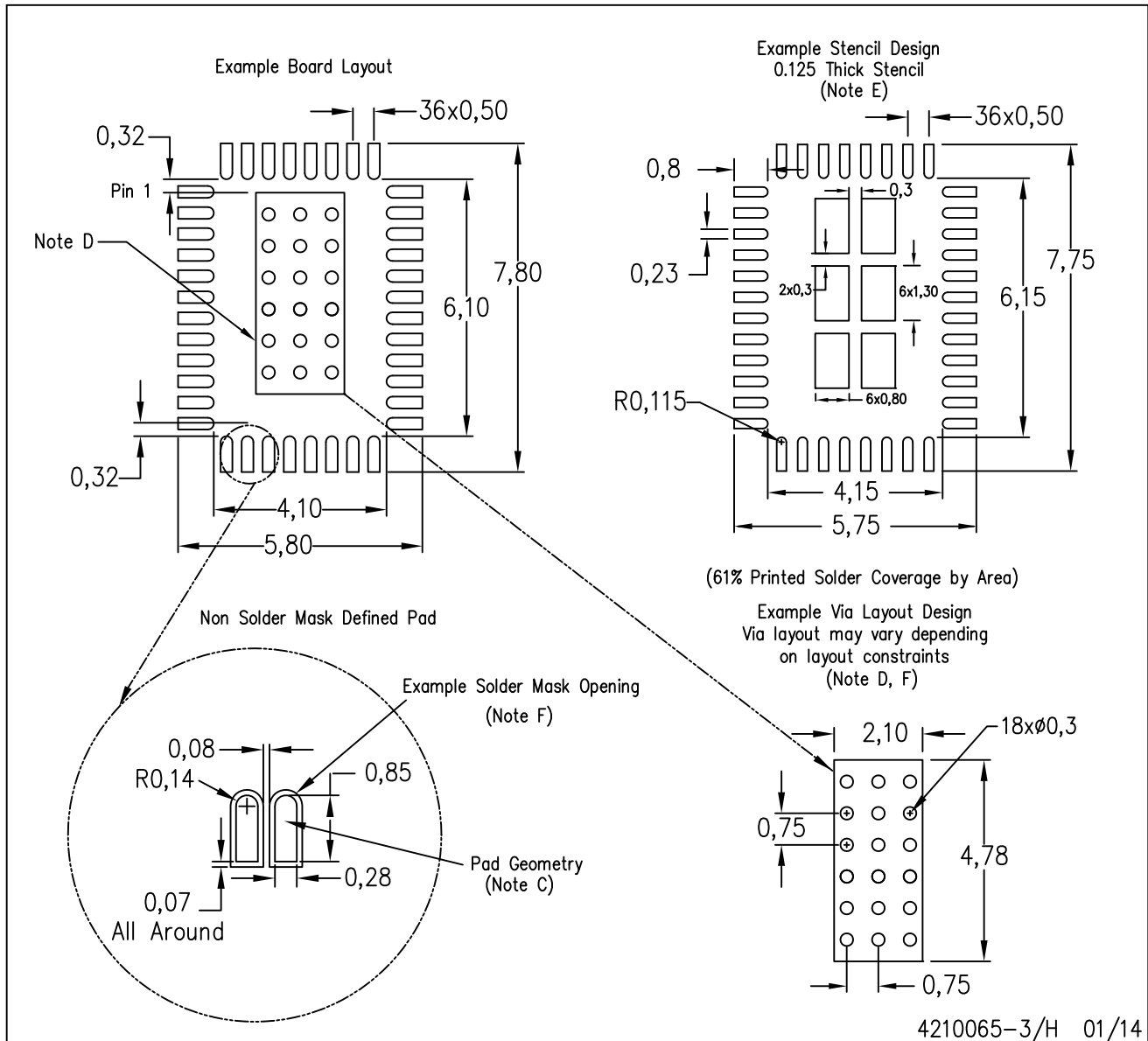

- NOTES:
- A. All linear dimensions are in millimeters.
 - B. This drawing is subject to change without notice.
 - C. Publication IPC-7351 is recommended for alternate designs.
 - D. This package is designed to be soldered to a thermal pad on the board. Refer to Application Note, QFN/SON PCB Attachment, Texas Instruments Literature No. SLUA271, and also the Product Data Sheets for specific thermal information, via requirements, and recommended board layout. These documents are available at www.ti.com <<http://www.ti.com>>.
 - E. Laser cutting apertures with trapezoidal walls and also rounding corners will offer better paste release. Customers should contact their board assembly site for stencil design recommendations. Refer to IPC 7525 for stencil design considerations.
 - F. Customers should contact their board fabrication site for recommended solder mask tolerances and via tenting recommendations for vias placed in the thermal pad.

IMPORTANT NOTICE

Texas Instruments Incorporated and its subsidiaries (TI) reserve the right to make corrections, enhancements, improvements and other changes to its semiconductor products and services per JESD46, latest issue, and to discontinue any product or service per JESD48, latest issue. Buyers should obtain the latest relevant information before placing orders and should verify that such information is current and complete. All semiconductor products (also referred to herein as "components") are sold subject to TI's terms and conditions of sale supplied at the time of order acknowledgment.

TI warrants performance of its components to the specifications applicable at the time of sale, in accordance with the warranty in TI's terms and conditions of sale of semiconductor products. Testing and other quality control techniques are used to the extent TI deems necessary to support this warranty. Except where mandated by applicable law, testing of all parameters of each component is not necessarily performed.

TI assumes no liability for applications assistance or the design of Buyers' products. Buyers are responsible for their products and applications using TI components. To minimize the risks associated with Buyers' products and applications, Buyers should provide adequate design and operating safeguards.

TI does not warrant or represent that any license, either express or implied, is granted under any patent right, copyright, mask work right, or other intellectual property right relating to any combination, machine, or process in which TI components or services are used. Information published by TI regarding third-party products or services does not constitute a license to use such products or services or a warranty or endorsement thereof. Use of such information may require a license from a third party under the patents or other intellectual property of the third party, or a license from TI under the patents or other intellectual property of TI.

Reproduction of significant portions of TI information in TI data books or data sheets is permissible only if reproduction is without alteration and is accompanied by all associated warranties, conditions, limitations, and notices. TI is not responsible or liable for such altered documentation. Information of third parties may be subject to additional restrictions.

Resale of TI components or services with statements different from or beyond the parameters stated by TI for that component or service voids all express and any implied warranties for the associated TI component or service and is an unfair and deceptive business practice. TI is not responsible or liable for any such statements.

Buyer acknowledges and agrees that it is solely responsible for compliance with all legal, regulatory and safety-related requirements concerning its products, and any use of TI components in its applications, notwithstanding any applications-related information or support that may be provided by TI. Buyer represents and agrees that it has all the necessary expertise to create and implement safeguards which anticipate dangerous consequences of failures, monitor failures and their consequences, lessen the likelihood of failures that might cause harm and take appropriate remedial actions. Buyer will fully indemnify TI and its representatives against any damages arising out of the use of any TI components in safety-critical applications.

In some cases, TI components may be promoted specifically to facilitate safety-related applications. With such components, TI's goal is to help enable customers to design and create their own end-product solutions that meet applicable functional safety standards and requirements. Nonetheless, such components are subject to these terms.

No TI components are authorized for use in FDA Class III (or similar life-critical medical equipment) unless authorized officers of the parties have executed a special agreement specifically governing such use.

Only those TI components which TI has specifically designated as military grade or "enhanced plastic" are designed and intended for use in military/aerospace applications or environments. Buyer acknowledges and agrees that any military or aerospace use of TI components which have **not** been so designated is solely at the Buyer's risk, and that Buyer is solely responsible for compliance with all legal and regulatory requirements in connection with such use.

TI has specifically designated certain components as meeting ISO/TS16949 requirements, mainly for automotive use. In any case of use of non-designated products, TI will not be responsible for any failure to meet ISO/TS16949.

Products

Audio	www.ti.com/audio
Amplifiers	amplifier.ti.com
Data Converters	dataconverter.ti.com
DLP® Products	www.dlp.com
DSP	dsp.ti.com
Clocks and Timers	www.ti.com/clocks
Interface	interface.ti.com
Logic	logic.ti.com
Power Mgmt	power.ti.com
Microcontrollers	microcontroller.ti.com
RFID	www.ti-rfid.com
OMAP Applications Processors	www.ti.com/omap
Wireless Connectivity	www.ti.com/wirelessconnectivity

Applications

Automotive and Transportation	www.ti.com/automotive
Communications and Telecom	www.ti.com/communications
Computers and Peripherals	www.ti.com/computers
Consumer Electronics	www.ti.com/consumer-apps
Energy and Lighting	www.ti.com/energy
Industrial	www.ti.com/industrial
Medical	www.ti.com/medical
Security	www.ti.com/security
Space, Avionics and Defense	www.ti.com/space-avionics-defense
Video and Imaging	www.ti.com/video

TI E2E Community

e2e.ti.com

AMEYA360

Components Supply Platform

Authorized Distribution Brand :



Website :

Welcome to visit www.ameya360.com

Contact Us :

➤ Address :

401 Building No.5, JiuGe Business Center, Lane 2301, Yishan Rd
Minhang District, Shanghai , China

➤ Sales :

Direct +86 (21) 6401-6692

Email amall@ameya360.com

QQ 800077892

Skype [ameyasales1](#) [ameyasales2](#)

➤ Customer Service :

Email service@ameya360.com

➤ Partnership :

Tel +86 (21) 64016692-8333

Email mkt@ameya360.com