

# NCV8440, NCV8440A

## Protected Power MOSFET

2.6 A, 52 V, N-Channel, Logic Level,  
Clamped MOSFET w/ ESD Protection

### Features

- Diode Clamp Between Gate and Source
- ESD Protection – Human Body Model 5000 V
- Active Over-Voltage Gate to Drain Clamp
- Scalable to Lower or Higher  $R_{DS(on)}$
- Internal Series Gate Resistance
- These are Pb-Free Devices

### Benefits

- High Energy Capability for Inductive Loads
- Low Switching Noise Generation

### Applications

- Automotive and Industrial Markets:  
Solenoid Drivers, Lamp Drivers, Small Motor Drivers
- NCV Prefix for Automotive and Other Applications Requiring Site and Control Changes



ON Semiconductor®

<http://onsemi.com>

$V_{DSS}$ (Clamped)	$R_{DS(on)}$ TYP	$I_D$ MAX
52 V	95 mΩ @ 10 V	2.6 A

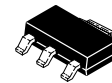
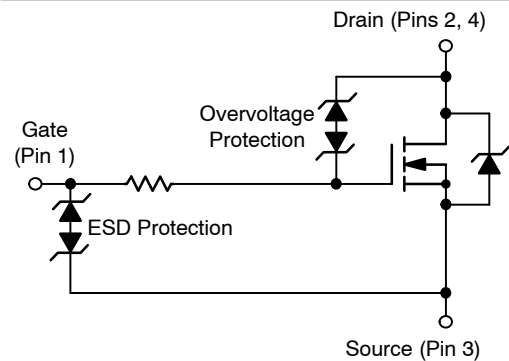

SOT-223  
CASE 318E  
STYLE 3

1 = Gate  
2 = Drain  
3 = Source

### MARKING DIAGRAM

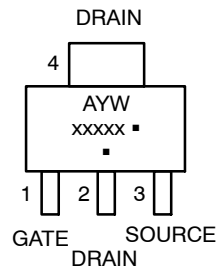

A = Assembly Location  
Y = Year  
W = Work Week  
xxxxx = V8440 or 8440A  
▪ = Pb-Free Package

(Note: Microdot may be in either location)

### ORDERING INFORMATION

See detailed ordering and shipping information in the package dimensions section on page 8 of this data sheet.

# NCV8440, NCV8440A

## MAXIMUM RATINGS ( $T_J = 25^\circ\text{C}$ unless otherwise noted)

Rating	Symbol	Value	Unit
Drain-to-Source Voltage Internally Clamped	$V_{DSS}$	52-59	V
Gate-to-Source Voltage – Continuous	$V_{GS}$	$\pm 15$	V
Drain Current – Continuous @ $T_A = 25^\circ\text{C}$ – Single Pulse ( $t_p = 10 \mu\text{s}$ ) (Note 1)	$I_D$	2.6	A
	$I_{DM}$	10	A
Total Power Dissipation @ $T_A = 25^\circ\text{C}$ (Note 1)	$P_D$	1.69	W
Operating and Storage Temperature Range	$T_J, T_{stg}$	-55 to 150	$^\circ\text{C}$
Single Pulse Drain-to-Source Avalanche Energy ( $V_{DD} = 50 \text{ V}$ , $I_{D(pk)} = 1.17 \text{ A}$ , $V_{GS} = 10 \text{ V}$ , $L = 160 \text{ mH}$ , $R_G = 25 \Omega$ )	$E_{AS}$	110	mJ
Load Dump Voltage ( $V_{GS} = 0$ and $10 \text{ V}$ , $R_I = 2.0 \Omega$ , $R_L = 9.0 \Omega$ , $t_d = 400 \text{ ms}$ )	$V_{LD}$	60	V
Thermal Resistance, Junction-to-Ambient (Note 1) Junction-to-Ambient (Note 2)	$R_{\theta JA}$	74	$^\circ\text{C/W}$
	$R_{\theta JA}$	169	$^\circ\text{C/W}$
Maximum Lead Temperature for Soldering Purposes, 1/8" from Case for 10 Seconds	$T_L$	260	$^\circ\text{C}$

Stresses exceeding Maximum Ratings may damage the device. Maximum Ratings are stress ratings only. Functional operation above the Recommended Operating Conditions is not implied. Extended exposure to stresses above the Recommended Operating Conditions may affect device reliability.

- When surface mounted to a FR4 board using 1" pad size, (Cu area 1.127 in<sup>2</sup>).
- When surface mounted to a FR4 board using minimum recommended pad size, (Cu area 0.412 in<sup>2</sup>).

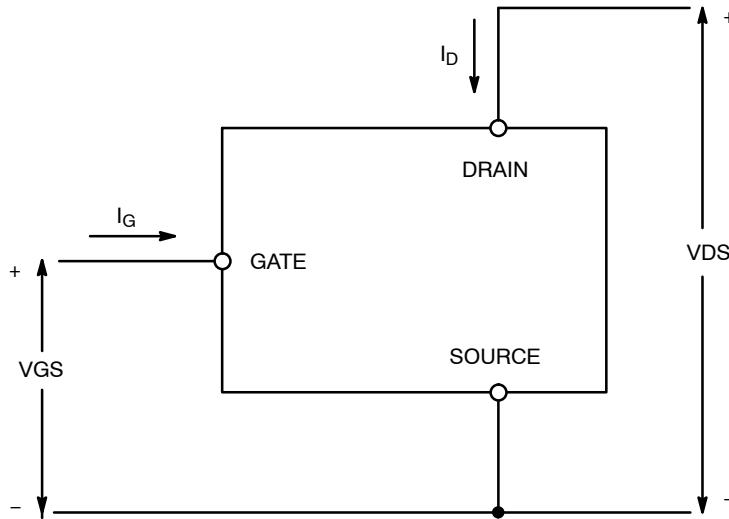

Figure 1. Voltage and Current Convention

# NCV8440, NCV8440A

## MOSFET ELECTRICAL CHARACTERISTICS (T<sub>J</sub> = 25°C unless otherwise noted)

Characteristic	Symbol	Min	Typ	Max	Unit
----------------	--------	-----	-----	-----	------

### OFF CHARACTERISTICS

Drain-to-Source Breakdown Voltage (Note 3) (V <sub>GS</sub> = 0 V, I <sub>D</sub> = 1.0 mA, T <sub>J</sub> = 25°C) (V <sub>GS</sub> = 0 V, I <sub>D</sub> = 1.0 mA, T <sub>J</sub> = -40°C to 125°C) (Note 4) Temperature Coefficient (Negative)	V <sub>(BR)DSS</sub>	52 50.8	55 54 -9.3	59 59.5	V V mV/°C
Zero Gate Voltage Drain Current (V <sub>DS</sub> = 40 V, V <sub>GS</sub> = 0 V) (V <sub>DS</sub> = 40 V, V <sub>GS</sub> = 0 V, T <sub>J</sub> = 125°C) (Note 4)	I <sub>DSS</sub>			10 25	μA
Gate-Body Leakage Current (V <sub>GS</sub> = ±8 V, V <sub>DS</sub> = 0 V) (V <sub>GS</sub> = ±14 V, V <sub>DS</sub> = 0 V)	I <sub>GSS</sub>		±35	±10	μA

### ON CHARACTERISTICS (Note 3)

Gate Threshold Voltage (Note 3) (V <sub>DS</sub> = V <sub>GS</sub> , I <sub>D</sub> = 100 μA) Threshold Temperature Coefficient (Negative)	V <sub>GS(th)</sub>	1.1	1.5 -4.1	1.9	V mV/°C
Static Drain-to-Source On-Resistance (Note 3) (V <sub>GS</sub> = 3.5 V, I <sub>D</sub> = 0.6 A) (V <sub>GS</sub> = 4.0 V, I <sub>D</sub> = 1.5 A) (V <sub>GS</sub> = 10 V, I <sub>D</sub> = 2.6 A)	R <sub>DS(on)</sub>		135 150 95	180 160 110	mΩ
Forward Transconductance (Note 3) (V <sub>DS</sub> = 15 V, I <sub>D</sub> = 2.6 A)	g <sub>FS</sub>		3.8		Mhos

### DYNAMIC CHARACTERISTICS

Input Capacitance	V <sub>DS</sub> = 35 V, V <sub>GS</sub> = 0 V, f = 10 kHz	C <sub>iss</sub>	155		pF
Output Capacitance		C <sub>oss</sub>	60		
Transfer Capacitance		C <sub>rss</sub>	25		
Input Capacitance	V <sub>DS</sub> = 25 V, V <sub>GS</sub> = 0 V, f = 10 kHz	C <sub>iss</sub>	170		pF
Output Capacitance		C <sub>oss</sub>	70		
Transfer Capacitance		C <sub>rss</sub>	30		

3. Pulse Test: Pulse Width ≤ 300 μs, Duty Cycle ≤ 2%.
4. Not subject to production testing.
5. Switching characteristics are independent of operating junction temperatures.

# NCV8440, NCV8440A

## MOSFET ELECTRICAL CHARACTERISTICS ( $T_J = 25^\circ\text{C}$ unless otherwise noted)

Characteristic		Symbol	Min	Typ	Max	Unit
<b>SWITCHING CHARACTERISTICS (Note 5)</b>						
Turn-On Delay Time	$V_{GS} = 4.5\text{ V}, V_{DD} = 40\text{ V},$ $I_D = 2.6\text{ A}, R_D = 15.4\ \Omega$	$t_{d(on)}$		375		ns
Rise Time		$t_r$		1525		
Turn-Off Delay Time		$t_{d(off)}$		1530		
Fall Time		$t_f$		1160		
Turn-On Delay Time	$V_{GS} = 4.5\text{ V}, V_{DD} = 40\text{ V},$ $I_D = 1.0\text{ A}, R_D = 40\ \Omega$	$t_{d(on)}$		325		ns
Rise Time		$t_r$		1275		
Turn-Off Delay Time		$t_{d(off)}$		1860		
Fall Time		$t_f$		1150		
Turn-On Delay Time	$V_{GS} = 10\text{ V}, V_{DD} = 15\text{ V},$ $I_D = 2.6\text{ A}, R_D = 5.8\ \Omega$	$t_{d(on)}$		190		ns
Rise Time		$t_r$		710		
Turn-Off Delay Time		$t_{d(off)}$		2220		
Fall Time		$t_f$		1180		
Gate Charge	$V_{GS} = 4.5\text{ V}, V_{DS} = 40\text{ V},$ $I_D = 2.6\text{ A (Note 3)}$	$Q_T$		4.5		nC
		$Q_1$		0.9		
		$Q_2$		2.6		
Gate Charge	$V_{GS} = 4.5\text{ V}, V_{DS} = 15\text{ V},$ $I_D = 1.5\text{ A (Note 3)}$	$Q_T$		3.9		nC
		$Q_1$		1.0		
		$Q_2$		1.7		

## SOURCE-DRAIN DIODE CHARACTERISTICS

Forward On-Voltage	$I_S = 2.6\text{ A}, V_{GS} = 0\text{ V (Note 3)}$ $I_S = 2.6\text{ A}, V_{GS} = 0\text{ V}, T_J = 125^\circ\text{C}$	$V_{SD}$		0.81 0.66	1.5	V
Reverse Recovery Time	$I_S = 1.5\text{ A}, V_{GS} = 0\text{ V},$ $di_S/dt = 100\text{ A}/\mu\text{s (Note 3)}$	$t_{rr}$		730		ns
		$t_a$		200		
		$t_b$		530		
Reverse Recovery Stored Charge		$Q_{RR}$		6.3		$\mu\text{C}$

## ESD CHARACTERISTICS (Note 4)

Electro-Static Discharge Capability	Human Body Model (HBM)	ESD	5000			V
	Machine Model (MM)		500			

3. Pulse Test: Pulse Width  $\leq 300\ \mu\text{s}$ , Duty Cycle  $\leq 2\%$ .
4. Not subject to production testing.
5. Switching characteristics are independent of operating junction temperatures.

TYPICAL PERFORMANCE CURVES

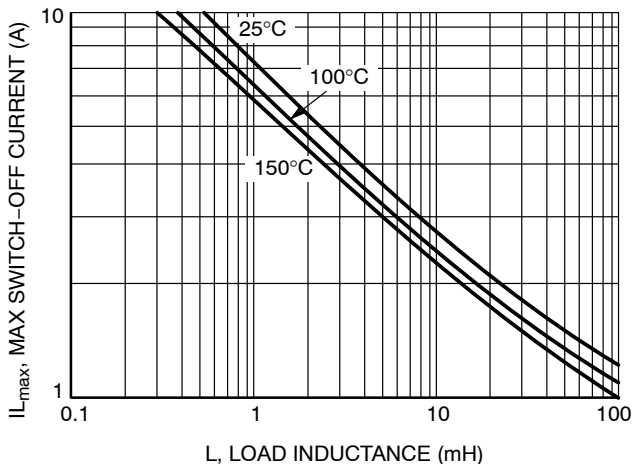

Figure 1. Single Pulse Maximum Switch-off Current vs. Load Inductance

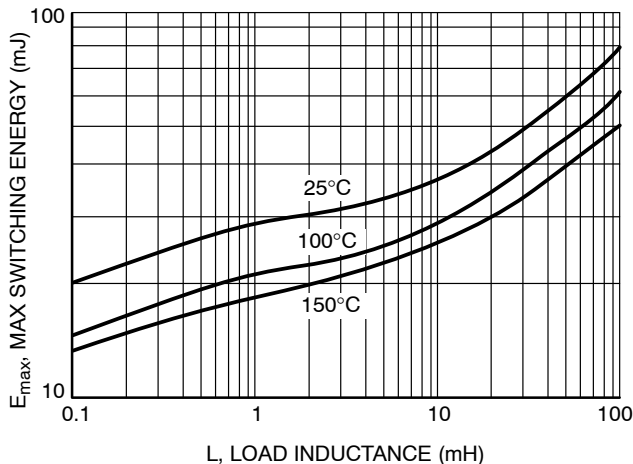

Figure 2. Single Pulse Maximum Switching Energy vs. Load Inductance

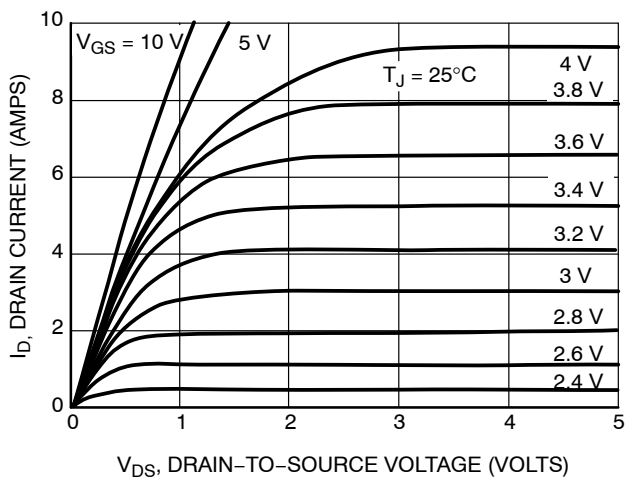

Figure 3. On-State Output Characteristics

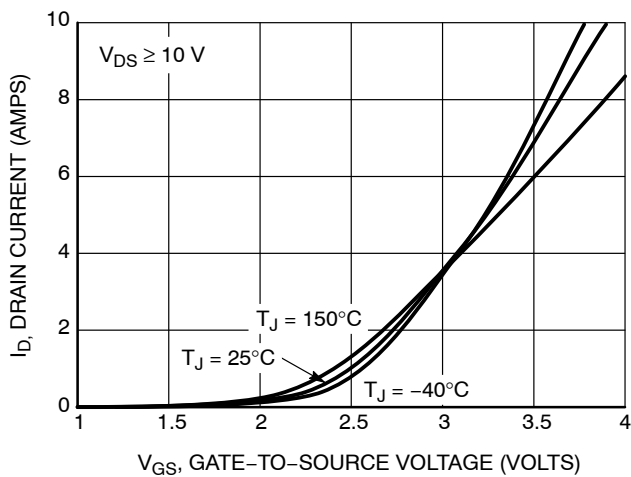

Figure 4. Transfer Characteristics

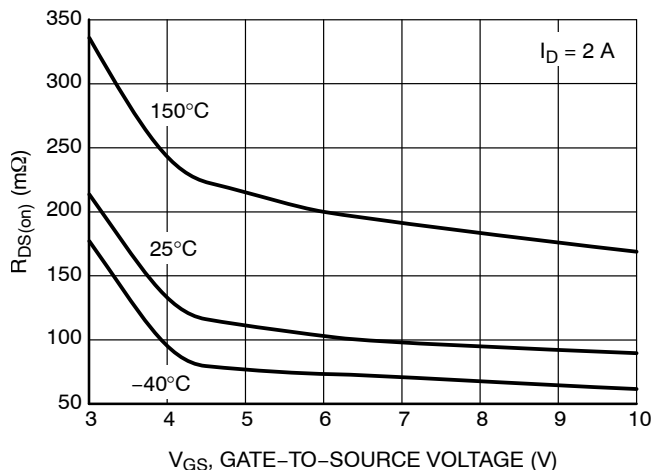

Figure 5.  $R_{DS(on)}$  vs. Gate-Source Voltage

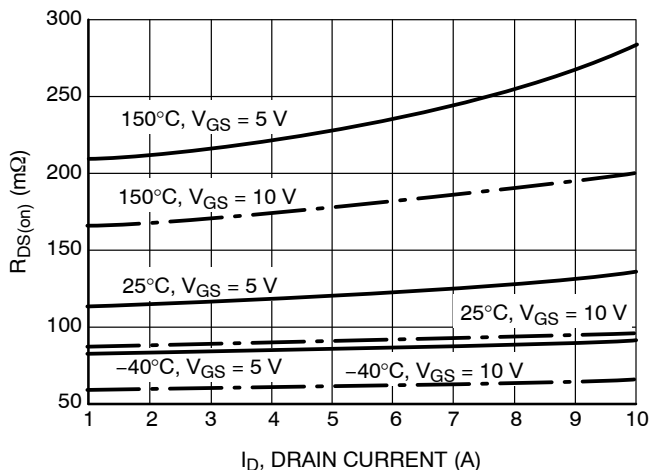

Figure 6.  $R_{DS(on)}$  vs. Drain Current

TYPICAL PERFORMANCE CURVES

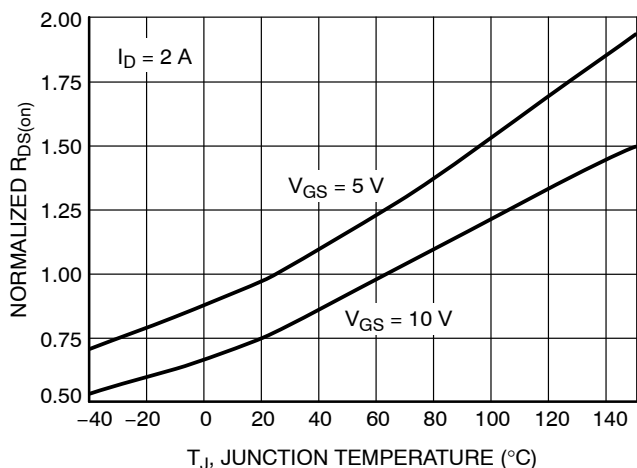

Figure 7. Normalized  $R_{DS(on)}$  vs. Temperature

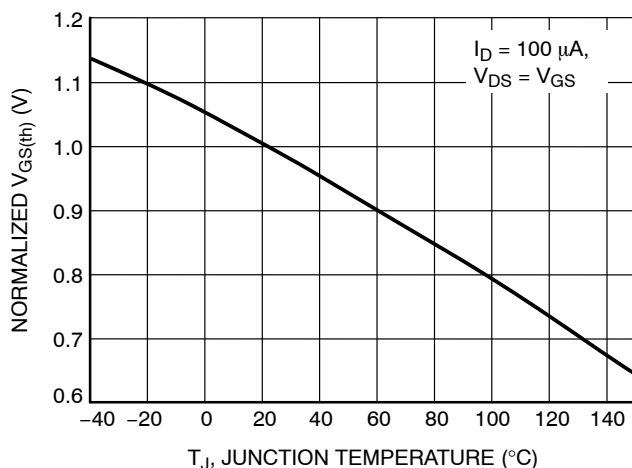

Figure 8. Normalized Threshold Voltage vs. Temperature

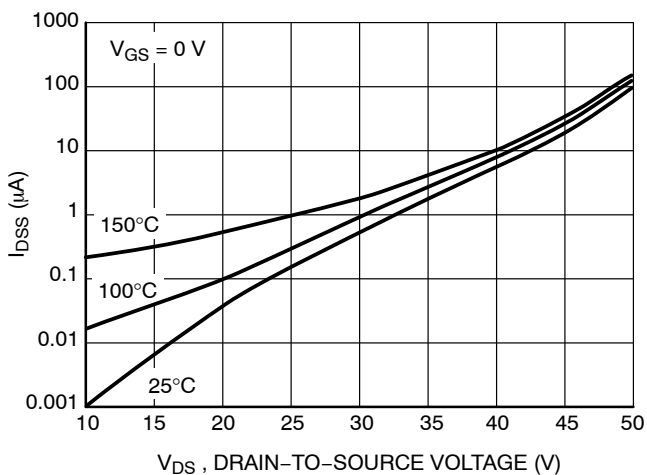

Figure 9. Drain-to-Source Leakage Current

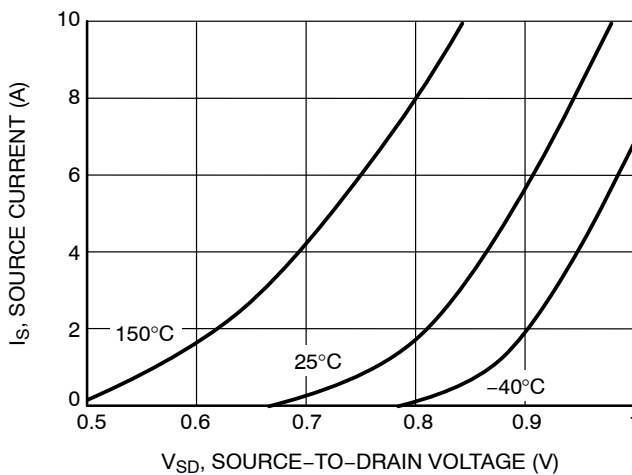

Figure 10. Source-Drain Diode Forward Characteristics

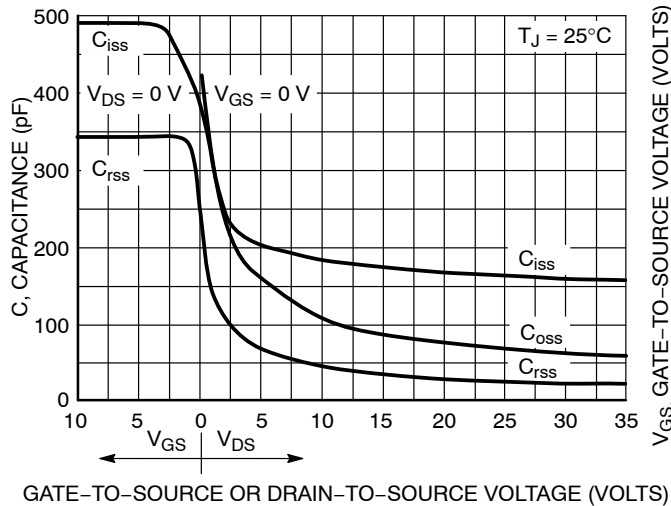

Figure 11. Capacitance Variation

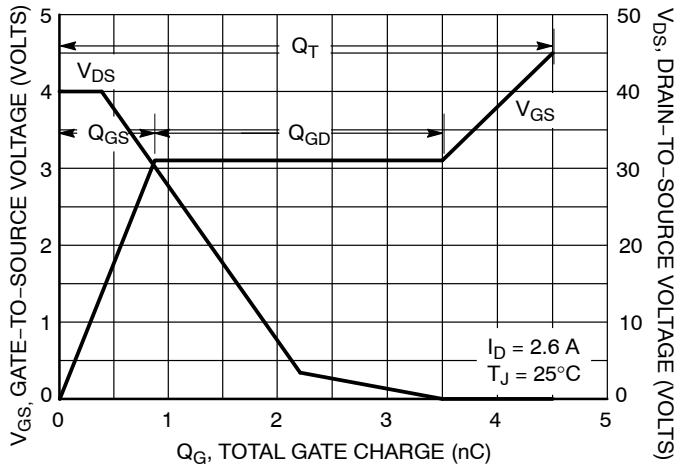
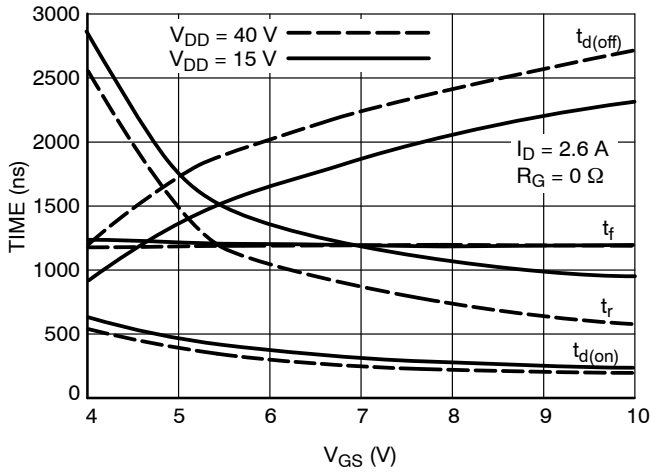

Figure 12. Gate-to-Source Voltage vs. Total Gate Charge

# NCV8440, NCV8440A

## TYPICAL PERFORMANCE CURVES



**Figure 13. Resistive Load Switching Time vs. Gate-Source Voltage**

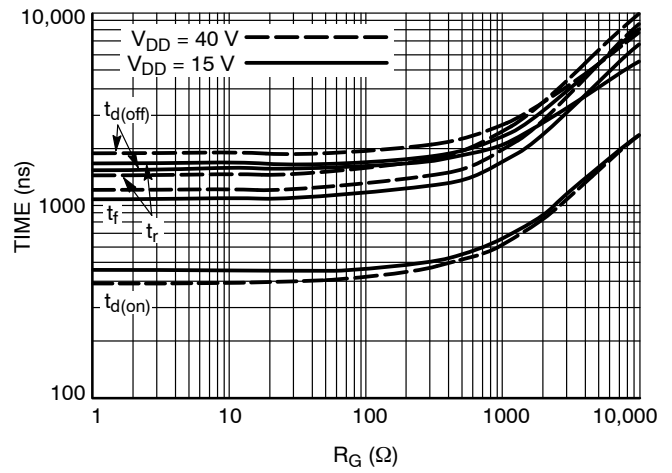

**Figure 14. Resistive Load Switching Time vs. Gate Resistance ( $V_{GS} = 5\text{ V}$ ,  $I_D = 2.6\text{ A}$ )**

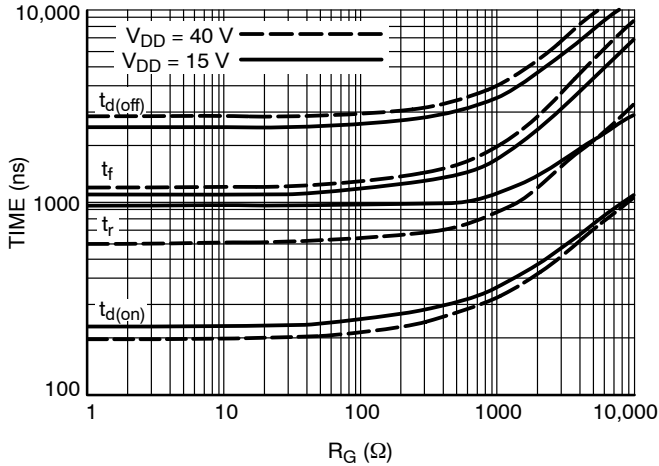

**Figure 15. Resistive Load Switching Time vs. Gate Resistance ( $V_{GS} = 10\text{ V}$ ,  $I_D = 2.6\text{ A}$ )**

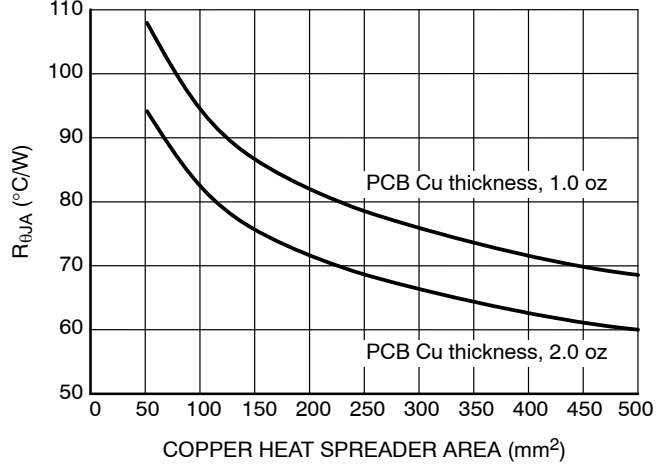

**Figure 16.  $R_{\theta JA}$  vs. Copper Area**

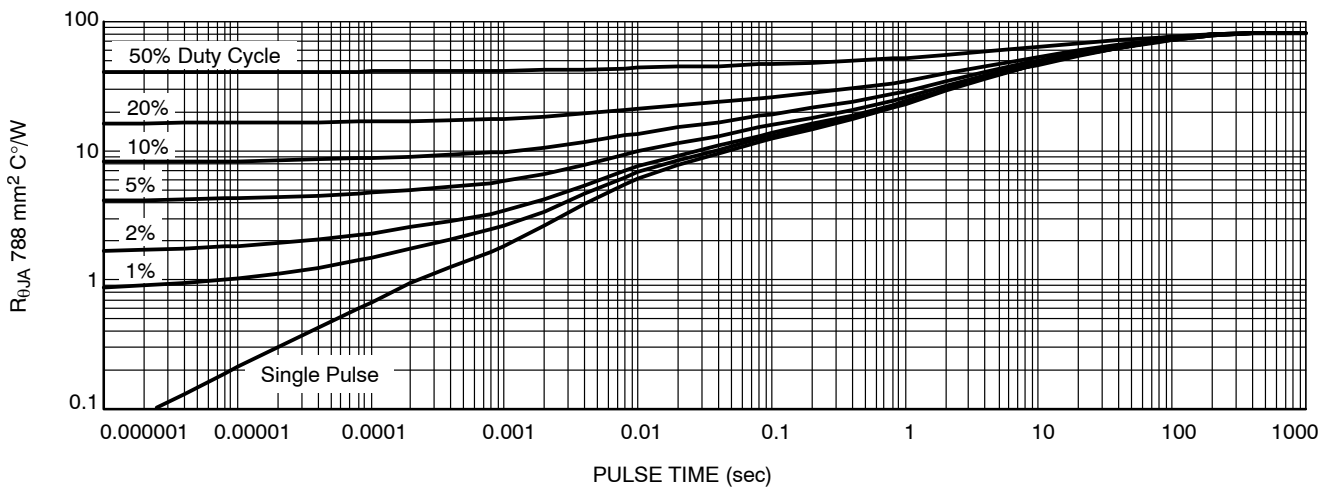

**Figure 17. Transient Thermal Resistance**

# NCV8440, NCV8440A

## ORDERING INFORMATION

Device	Package	Shipping†
NCV8440STT1G	SOT-223 (Pb-Free)	1000 / Tape & Reel
NCV8440ASTT1G	SOT-223 (Pb-Free)	1000 / Tape & Reel
NCV8440STT3G	SOT-223 (Pb-Free)	4000 / Tape & Reel
NCV8440ASTT3G	SOT-223 (Pb-Free)	4000 / Tape & Reel

†For information on tape and reel specifications, including part orientation and tape sizes, please refer to our Tape and Reel Packaging Specifications Brochure, BRD8011/D.



# NCV8440, NCV8440A

## PACKAGE DIMENSIONS

SOT-223 (TO-261)  
CASE 318E-04  
ISSUE N

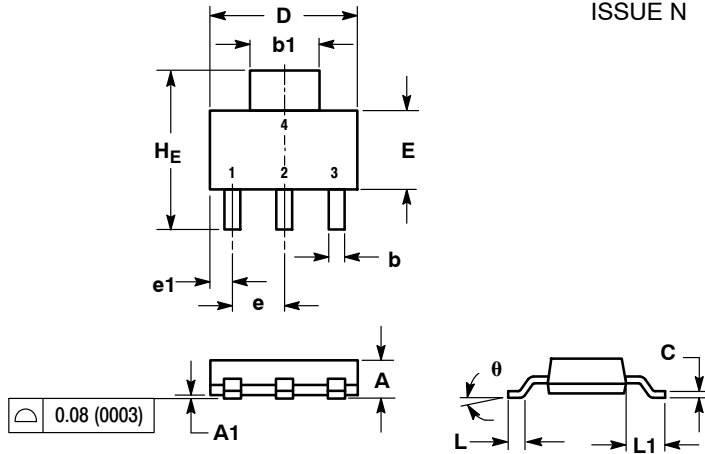

NOTES:

1. DIMENSIONING AND TOLERANCING PER ASME Y14.5M, 1994.
2. CONTROLLING DIMENSION: INCH.

DIM	MILLIMETERS			INCHES		
	MIN	NOM	MAX	MIN	NOM	MAX
A	1.50	1.63	1.75	0.060	0.064	0.068
A1	0.02	0.06	0.10	0.001	0.002	0.004
b	0.60	0.75	0.89	0.024	0.030	0.035
b1	2.90	3.06	3.20	0.115	0.121	0.126
c	0.24	0.29	0.35	0.009	0.012	0.014
D	6.30	6.50	6.70	0.249	0.256	0.263
E	3.30	3.50	3.70	0.130	0.138	0.145
e	2.20	2.30	2.40	0.087	0.091	0.094
e1	0.85	0.94	1.05	0.033	0.037	0.041
L	0.20	---	---	0.008	---	---
L1	1.50	1.75	2.00	0.060	0.069	0.078
HE	6.70	7.00	7.30	0.264	0.276	0.287
θ	0°	-	10°	0°	-	10°

STYLE 3:

- PIN 1. GATE
- DRAIN
- SOURCE
- DRAIN

### SOLDERING FOOTPRINT\*

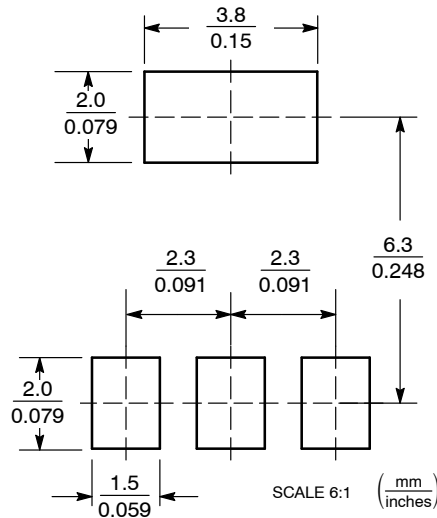

\*For additional information on our Pb-Free strategy and soldering details, please download the ON Semiconductor Soldering and Mounting Techniques Reference Manual, SOLDERRM/D.

ON Semiconductor and are registered trademarks of Semiconductor Components Industries, LLC (SCILLC). SCILLC reserves the right to make changes without further notice to any products herein. SCILLC makes no warranty, representation or guarantee regarding the suitability of its products for any particular purpose, nor does SCILLC assume any liability arising out of the application or use of any product or circuit, and specifically disclaims any and all liability, including without limitation special, consequential or incidental damages. "Typical" parameters which may be provided in SCILLC data sheets and/or specifications can and do vary in different applications and actual performance may vary over time. All operating parameters, including "Typicals" must be validated for each customer application by customer's technical experts. SCILLC does not convey any license under its patent rights nor the rights of others. SCILLC products are not designed, intended, or authorized for use as components in systems intended for surgical implant into the body, or other applications intended to support or sustain life, or for any other application in which the failure of the SCILLC product could create a situation where personal injury or death may occur. Should Buyer purchase or use SCILLC products for any such unintended or unauthorized application, Buyer shall indemnify and hold SCILLC and its officers, employees, subsidiaries, affiliates, and distributors harmless against all claims, costs, damages, and expenses, and reasonable attorney fees arising out of, directly or indirectly, any claim of personal injury or death associated with such unintended or unauthorized use, even if such claim alleges that SCILLC was negligent regarding the design or manufacture of the part. SCILLC is an Equal Opportunity/Affirmative Action Employer. This literature is subject to all applicable copyright laws and is not for resale in any manner.

### PUBLICATION ORDERING INFORMATION

**LITERATURE FULFILLMENT:**  
Literature Distribution Center for ON Semiconductor  
P.O. Box 5163, Denver, Colorado 80217 USA  
**Phone:** 303-675-2175 or 800-344-3860 Toll Free USA/Canada  
**Fax:** 303-675-2176 or 800-344-3867 Toll Free USA/Canada  
**Email:** orderlit@onsemi.com

**N. American Technical Support:** 800-282-9855 Toll Free USA/Canada  
**Europe, Middle East and Africa Technical Support:**  
Phone: 421 33 790 2910  
**Japan Customer Focus Center**  
Phone: 81-3-5817-1050

**ON Semiconductor Website:** [www.onsemi.com](http://www.onsemi.com)  
**Order Literature:** <http://www.onsemi.com/orderlit>  
For additional information, please contact your local Sales Representative

# AMEYA360

## Components Supply Platform

Authorized Distribution Brand :



Website :

Welcome to visit [www.ameya360.com](http://www.ameya360.com)

Contact Us :

➤ Address :

401 Building No.5, JiuGe Business Center, Lane 2301, Yishan Rd  
Minhang District, Shanghai , China

➤ Sales :

Direct +86 (21) 6401-6692

Email [amall@ameya360.com](mailto:amall@ameya360.com)

QQ 800077892

Skype [ameyasales1](#) [ameyasales2](#)

➤ Customer Service :

Email [service@ameya360.com](mailto:service@ameya360.com)

➤ Partnership :

Tel +86 (21) 64016692-8333

Email [mkt@ameya360.com](mailto:mkt@ameya360.com)