

# Miniature Surface Mount LED—OPR5200 Phototransistor—OPR5500

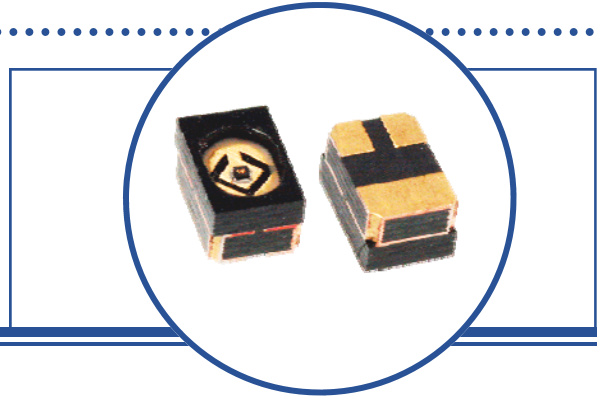

## Features:

- Stackable on 2 mm centers
- Vertical or horizontal mounting
- Automatic pick-and-place compatible
- Combine OPR5200 and OPR5500 to create miniature switch



## Description:

The **OPR5200** is a miniature high efficiency GaAlAs light emitting diode in a high temperature polyamide chip carrier that is well suited to space-limited applications which require close channel spacing.

The **OPR5500** is a miniature NPN silicon phototransistor housed in a high temperature polyamide chip carrier that is well suited to space-limited applications which require close channel spacing.

When combining the OPR5200 and OPR5500 (miniature phototransistor), this lateral mounting option can be used to create a non-focused reflective or slotted switch configuration.

These parts can be automatically placed with standard SMD equipment and can be reflow soldered by virtually any conventional means. Wraparound contacts allow it to be mounted face up or on edge for a beam direction parallel to the seating plane.

See Application Bulletin 237 for handling instructions

## Applications:

- Slotted switches
- Industrial environments
- Space-limited applications

Ordering Information						
Part Number	LED Peak Wavelength	Output Power (μW) Min	I <sub>F</sub> (mA) Typ / Max	Total Beam Angle (Degrees)	Rise / Fall Times (nS) Typ	Packaging
OPR5200	890 nm	350	20 / 50	90	500 / 250	Chip Tray
Part Number	Sensor	Light Current I <sub>C(ON)</sub> (μA) Min	V <sub>CE</sub> Max	Input Power E <sub>E</sub> (μW/cm <sup>2</sup> )	Viewing Angle (Degrees)	Packaging
OPR5500	Transistor	36	30	150	120	Chip Tray

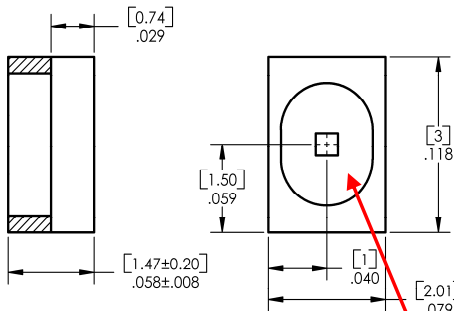
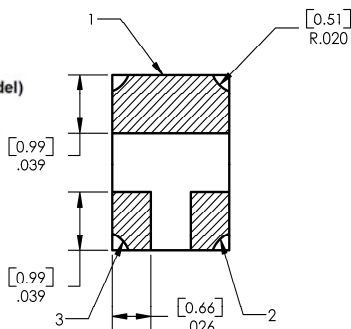

OPR5200		OPR5500	
Pin #	LED	Pin #	Transistor
1	Anode	1	Collector
2	Cathode	2	Emitter
3	N.C.	3	Base

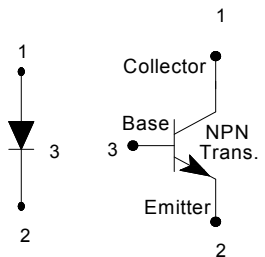

**Warning:** Front Window is pressure sensitive. Do not apply pressure or high vacuum to window.

TOLERANCE IS ± .005 [0.13]

DIMENSIONS ARE IN: [MILLIMETERS] INCHES



RoHS

OPTEK reserves the right to make changes at any time in order to improve design and to supply the best product possible.

# Miniature Surface Mount LED—OPR5200 Phototransistor—OPR5500



## OPR5200 Absolute Maximum Ratings ( $T_A = 25^\circ\text{C}$ unless otherwise noted)

Storage and Operating Temperature	-55° C to +125° C
Continuous Forward Current	50 mA
Peak Forward Current (1 $\mu\text{s}$ pulse width, 10% duty cycle)	1.0 A
Power Dissipation <sup>(1)</sup>	100 mW
Solder reflow time within 5° C of peak temperature is 20 to 40 seconds <sup>(2)</sup>	250° C

## OPR5200 Electrical Characteristics ( $T_A = 25^\circ\text{C}$ unless otherwise noted)

SYMBOL	PARAMETER	MIN	TYP	MAX	UNITS	TEST CONDITIONS
$P_O$	Output Power	350	-	-	$\mu\text{W}$	$I_F = 20\text{ mA}$
$V_F$	Forward Voltage	-	-	1.8	V	$I_F = 20\text{ mA}$
$I_R$	Reverse Current	-	-	100	$\mu\text{A}$	$V_R = 2\text{ V}$
$\lambda_P$	Peak Wavelength	-	890	-	nm	$I_F = 20\text{ mA}$
$\lambda_{BW}$	Spectral Bandwidth	-	80	-	nm	$I_F = 20\text{ mA}$
$\theta_{HP}$	Emission Angle	-	$\pm 45^\circ$	-	-	at half power points
$t_r$	Output Rise Time	-	500	-	ns	$I_P = 100\text{ mA}$ , $PW = 10.0\ \mu\text{s}$ , D.C. = 10%
$t_f$	Output Fall Time	-	250	-	ns	

Notes:

- (1) Derate at 1.00 mW/° C above 25° C.
- (2) Solder time less than 5 seconds at temperature extreme.

Forward Voltage vs Forward Current vs Temperature

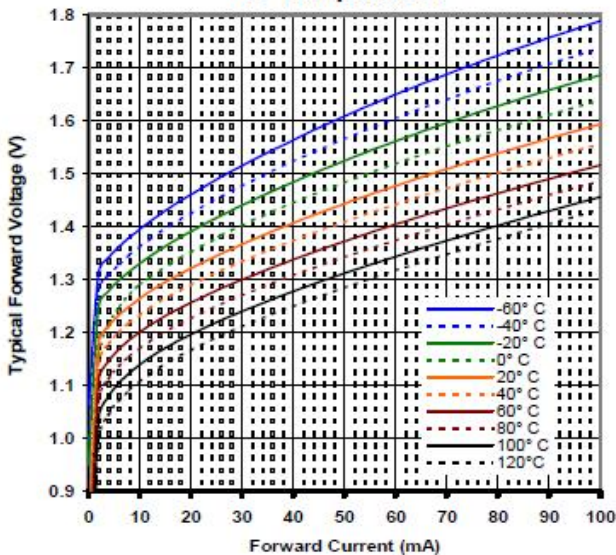

Optical Power vs  $I_F$  vs Temperature

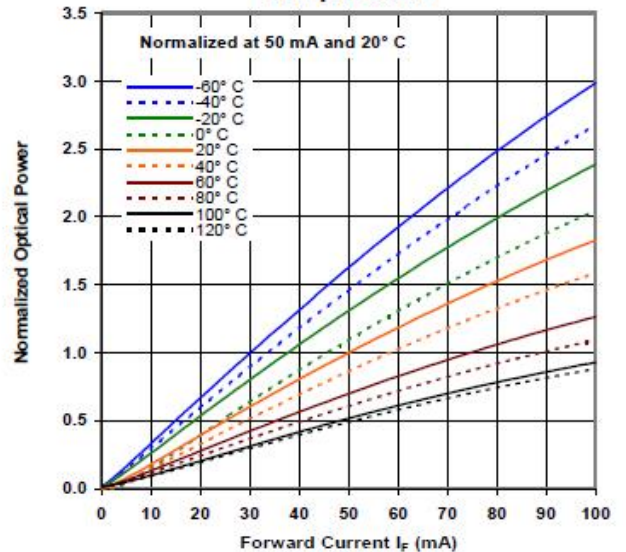

OPTEK reserves the right to make changes at any time in order to improve design and to supply the best product possible.

**Miniature Surface Mount  
LED—OPR5200  
Phototransistor—OPR5500**



**OPR5500 Absolute Maximum Ratings** ( $T_A = 25^\circ\text{C}$  unless otherwise noted)

Storage and Operating Temperature	-55° C to +125° C
Collector-Emitter Voltage	30 V
Emitter-Collector Voltage	5 V
Power Dissipation <sup>(1)</sup>	100 mW
Solder reflow time within 5°C of peak temperature is 20 to 40 seconds <sup>(2)</sup>	250° C

**OPR5500 Electrical Characteristics** ( $T_A = 25^\circ\text{C}$  unless otherwise noted)

SYMBOL	PARAMETER	MIN	TYP	MAX	UNITS	TEST CONDITIONS
$I_{C(ON)}$	On-State Collector Current	36	-	-	$\mu\text{A}$	$V_{CE} = 5\text{ V}$ , $E_e = 150\ \mu\text{W}/\text{cm}^2$ (890 nm light source)
$I_{CEO}$	Dark Current	-	-	100	nA	$V_{CE} = 5\text{ V}$ , $E_e = 0$
$V_{(BR)CEO}$	Collector-Emitter Breakdown Voltage	30	-	-	V	$I_C = 100\ \mu\text{A}$
$V_{(BR)ECO}$	Emitter-Collector Breakdown Voltage	5	-	-	V	$I_E = 100\ \mu\text{A}$
$V_{(SAT)}$	Saturation Voltage	-	-	0.4	V	$I_C = 100\ \mu\text{A}$ , $E_e = 5\ \text{mW}/\text{cm}^2$
$t_r, t_f$	Output Rise and Fall Time	-	2.5	-	$\mu\text{s}$	$V_{CC} = 5\text{ V}$ , $I_C = 800\ \mu\text{A}$ , $R_L = 100\ \Omega$

Notes:

- (1) Derate at 1.00 mW/° C above 25° C.
- (2) Solder time less than 5 seconds at temperature extreme.

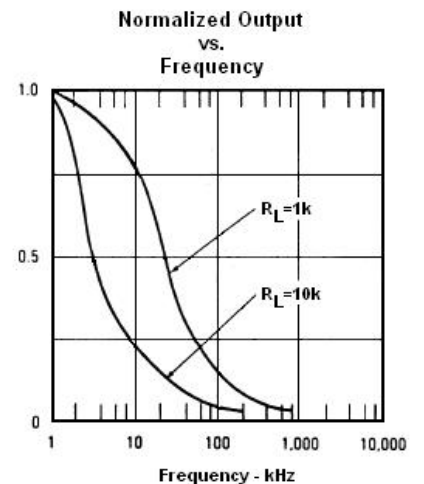
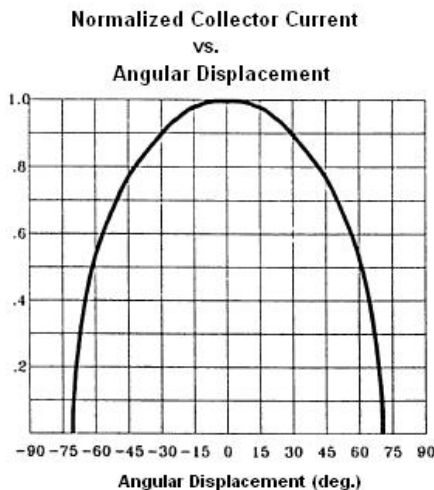
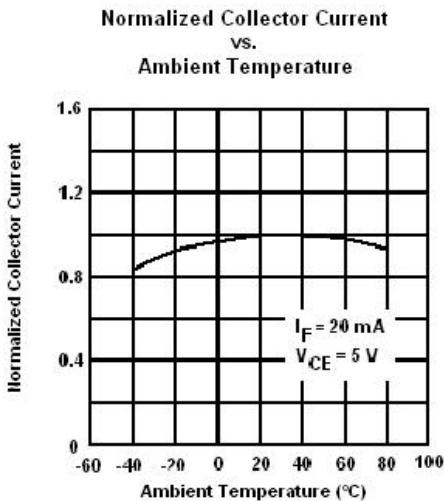

OPTEK reserves the right to make changes at any time in order to improve design and to supply the best product possible.

# AMEYA360

## Components Supply Platform

Authorized Distribution Brand :



Website :

Welcome to visit [www.ameya360.com](http://www.ameya360.com)

Contact Us :

➤ Address :

401 Building No.5, JiuGe Business Center, Lane 2301, Yishan Rd  
Minhang District, Shanghai , China

➤ Sales :

Direct +86 (21) 6401-6692

Email [amall@ameya360.com](mailto:amall@ameya360.com)

QQ 800077892

Skype [ameyasales1](#) [ameyasales2](#)

➤ Customer Service :

Email [service@ameya360.com](mailto:service@ameya360.com)

➤ Partnership :

Tel +86 (21) 64016692-8333

Email [mkt@ameya360.com](mailto:mkt@ameya360.com)