

# PC SCREW TERMINALS

These easy-to-mount, multipurpose screw type terminals are a practical, low-cost alternative to PC screw type edge connectors, barrier blocks, terminal boards and terminal strips. Steadfast and easy to install, will accommodate solid or stranded wire, crimp type terminals or lugs. Multi-placement of these low-profile terminals make them ideally suited for high density packaging. Supplied unassembled or with screw installed and captivated.

## PRINCIPAL FEATURES

- Low profile
- Stable, no-rock design with exclusive anti-rotational feature
- Easily mounts with four legs into pre-drilled or punched holes
- Accepts 14-22 AWG solid or stranded wire, crimp type terminals or lugs
- Ideally suited for high-density packaging
- Available in horizontal or vertical mounting
- Space-saving and time saving
- Easy accessibility for PC board testing
- Binding screw is positioned above board level to avoid wicking during wave soldering
- Terminals are made of Brass with Tin Plate
- Supplied with a combination drive 6-32 binding head screw

CAT. NO. COLOR SUFFIX  
Ex: XXXX -X

## COLOR SELECTION:

Select desired screw terminal and add color suffix to the screw terminal Cat. No.

HEAD COLOR	SUFFIX
RED	-2
BLACK	-3
WHITE	-4
BLUE	-5
GREEN	-6
YELLOW	-7
NICKEL	none

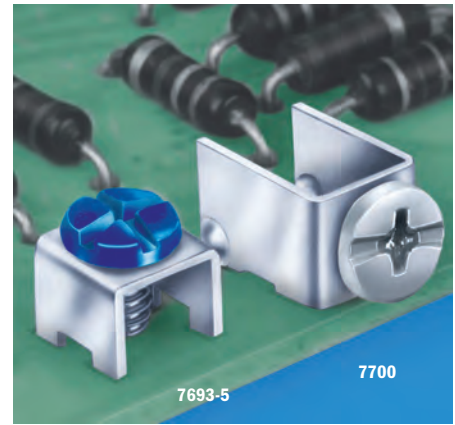

### SNAP-IN PC MOUNT

- Color coded screws available (add color screw suffix to Cat. No.)

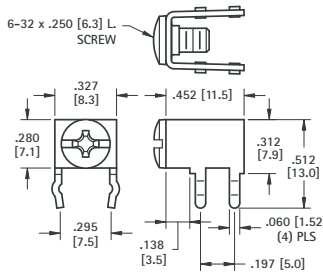

## HORIZONTAL TYPE

### SPECIFICATIONS

Rated: 15 Amps  
Terminal: .032 (.81) Brass, Matte Tin Plate  
Binding Head Screw: Brass, Nickel Plate

### Mounting Detail

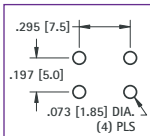

Color coded screws available (add color screw suffix to Cat. No.)

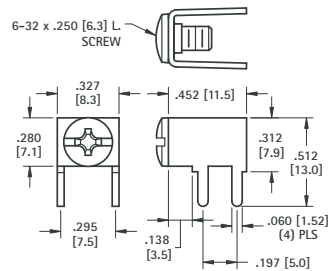

### PC MOUNT

- Color coded screws available (add color screw suffix to Cat. No.)

CAT. NO. 7779 (No Screw Supplied)

CAT. NO. 7690 (Screw Supplied Unassembled)

CAT. NO. 7692 (Screw Installed & Captivated)

CAT. NO. 7781 (No Screw Supplied)

CAT. NO. 8190 (Screw Supplied Unassembled)

CAT. NO. 7700 (Screw Installed & Captivated)



### SNAP-IN PC MOUNT

- Color coded screws available (add color screw suffix to Cat. No.)

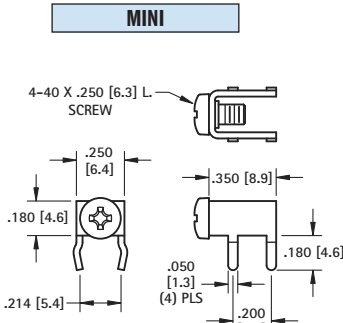

### Mounting Detail

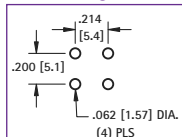

### SPECIFICATIONS

Rated: 15 Amps  
Terminal: .032 (.81) Brass, Matte Tin Plate  
Binding Head Screw: Brass, Nickel Plate

## 45°

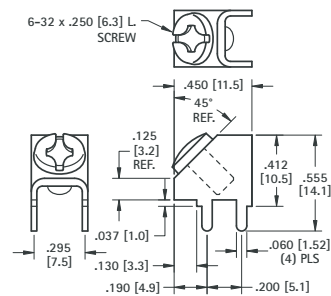

### PC MOUNT

- Color coded screws available (add color screw suffix to Cat. No.)

### Mounting Detail

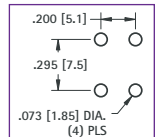

CAT. NO. 7774 (No Screw Supplied)

CAT. NO. 7773 (Screw Supplied Unassembled)

CAT. NO. 7783 (No Screw Supplied)

CAT. NO. 8189 (Screw Supplied Unassembled)

CAT. NO. 7702 (Screw Installed & Captivated)



### SNAP-IN PC MOUNT

- Color coded screws available (add color screw suffix to Cat. No.)

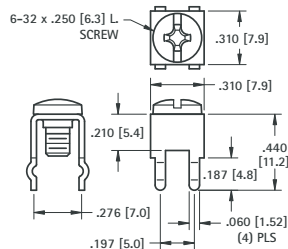

## VERTICAL TYPE

### SPECIFICATIONS

Rated: 15 Amps  
Terminal: .032 (.81) Brass, Matte Tin Plate  
Binding Head Screw: Brass, Nickel Plate

### Mounting Detail

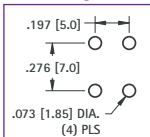

Color coded screws available (add color screw suffix to Cat. No.)

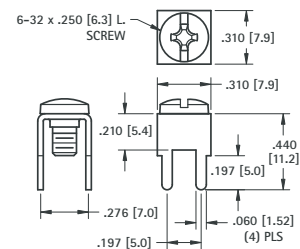

### PC MOUNT

- Color coded screws available (add color screw suffix to Cat. No.)

CAT. NO. 7780 (No Screw Supplied)

CAT. NO. 7691 (Screw Supplied Unassembled)

CAT. NO. 7693 (Screw Installed & Captivated)

CAT. NO. 7782 (No Screw Supplied)

CAT. NO. 8191 (Screw Supplied Unassembled)

CAT. NO. 7701 (Screw Installed & Captivated)

# PC SCREW TERMINALS

## LOW PROFILE VERTICAL TYPE



7778-7

- Color coded screws available (add color screw suffix to Cat. No.)

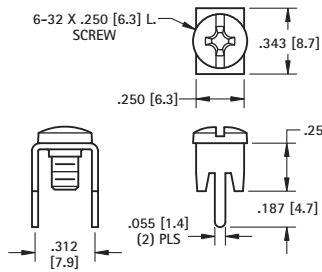

### SPECIFICATIONS

**Rated:** 15 Amps  
**Terminal:** .032 (.81) Brass, Matte Tin Plate  
**Binding Head Screw:** Brass, Nickel Plate

### Mounting Detail

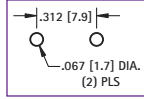

**CAT. NO. 7784** (No Screw Supplied)

**CAT. NO. 8198** (Screw Supplied Unassembled)

**CAT. NO. 7778** (Screw Installed & Captivated)



7775-2

- Color coded screws available (add color screw suffix to Cat. No.)

### Mounting Detail

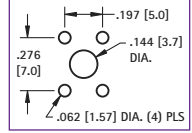

**CAT. NO. 7785** (No Screw Supplied)

**CAT. NO. 8195** (Screw Supplied Unassembled)

**CAT. NO. 7775** (Screw Installed & Captivated)

## VERTICAL TYPE

### EXTENDED



7699-6

### PC MOUNT

- Color coded screws available (add color screw suffix to Cat. No.)

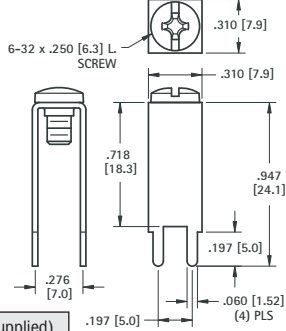

### SPECIFICATIONS

**Rated:** 15 Amps  
**Terminal:** .032 (.81) Brass, Matte Tin Plate  
**Binding Head Screw:** Brass, Nickel Plate

### Mounting Detail

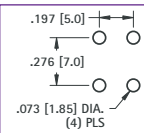

**CAT. NO. 7789** (No Screw Supplied)

**CAT. NO. 7697** (Screw Supplied Unassembled)

**CAT. NO. 7699** (Screw Installed & Captivated)

### HEAVY DUTY



8174

### Mounting Detail

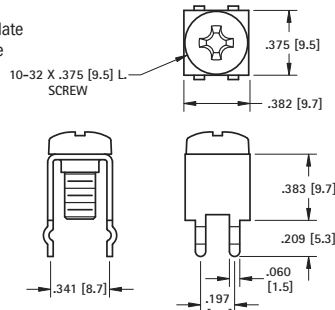
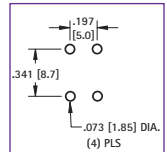

**CAT. NO. 7791** (No Screw Supplied)

**CAT. NO. 8174** (Screw Supplied Unassembled)

## 30 AMP - VERTICAL



8199-6

- Combination drive, binding head screw
- Color coded screws available (add color screw suffix to Cat. No.)

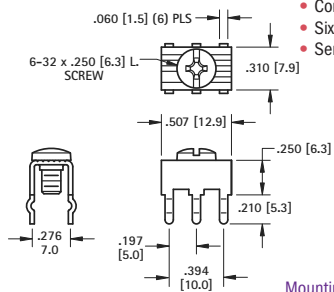

### PRINCIPAL FEATURES

- Compact, heavy duty design
- Six snap-in legs for total stability
- Serrated top surface secures connection

### Mounting Detail

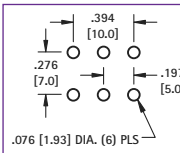

### SPECIFICATIONS

**Rated:** 30 Amps  
**Terminal:** .032 (.81) Brass, Matte Tin Plate  
**Binding Head Screw:** Brass, Nickel Plate

**CAT. NO. 7786** (No Screw Supplied)

**CAT. NO. 8197** (Screw Supplied Unassembled)

**CAT. NO. 8199** (Screw Installed & Captivated)

### HEAVY DUTY



8196

### Mounting Detail

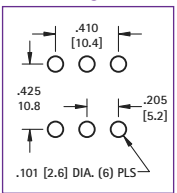

### SPECIFICATIONS

**Rated:** 30 Amps  
**Terminal:** .045 (1.14) Brass, Matte Tin Plate  
**Screw:** Stainless Steel

**CAT. NO. 7787** (No Screw Supplied)

**CAT. NO. 8196** (Screw Supplied Unassembled)

## COLOR CODED SCREW TERMINAL SELECTION GUIDE

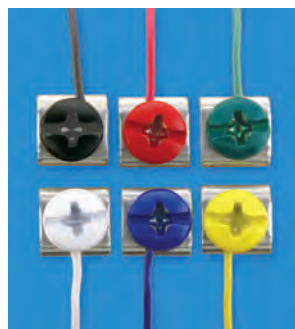

### Color Coded Screw Terminals provide:

- Quick identification
- Visibility for field service troubleshooting

### SPECIFICATIONS

**Combination Binding Head:**  
 Standard screw is Brass, Nickel Plate. For painted, color head, add suffix as shown.



**COLOR SELECTION:**  
 Select desired screw terminal and add color suffix to the screw terminal Cat. No.

HEAD COLOR	SUFFIX
RED	-2
BLACK	-3
WHITE	-4
BLUE	-5
GREEN	-6
YELLOW	-7
NICKEL	none

**CAT. NO. COLOR SUFFIX**  
 Ex: XXXX -X



Refer to page 133 for color screws only

# SEMS SCREW TERMINALS

15 AMP



**SNAP-IN  
PC MOUNT**

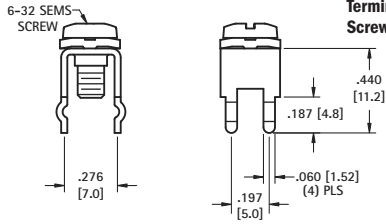

**SPECIFICATIONS**

**Terminal:** .032 (.81) Brass, Matte Tin Plate  
**Screw & Washer:** Steel, Nickel Plate

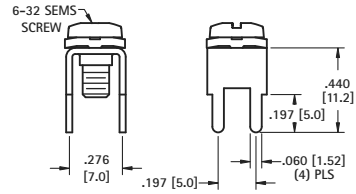

**PC MOUNT**

**CAT. NO. 7691-SEMS** (Screw Supplied Unassembled)

**CAT. NO. 7693-SEMS** (Screw Installed & Captivated)

**CAT. NO. 8191-SEMS** (Screw Supplied Unassembled)

**CAT. NO. 7701-SEMS** (Screw Installed & Captivated)



**SNAP-IN  
PC MOUNT**

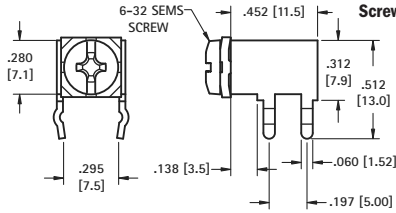

**SPECIFICATIONS**

**Terminal:** .032 (.81) Brass, Matte Tin Plate  
**Screw & Washer:** Steel, Nickel Plate

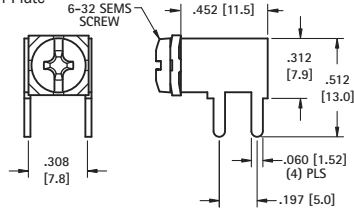

**PC MOUNT**

**CAT. NO. 7690-SEMS** (Screw Supplied Unassembled)

**CAT. NO. 7692-SEMS** (Screw Installed & Captivated)

**CAT. NO. 8190-SEMS** (Screw Supplied Unassembled)

**CAT. NO. 7700-SEMS** (Screw Installed & Captivated)



**SNAP-IN  
PC MOUNT**

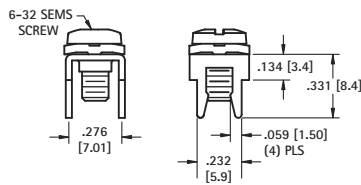

**SPECIFICATIONS**

**Terminal:** .032 (.81) Brass, Matte Tin Plate  
**Screw & Washer:** Steel, Nickel Plate

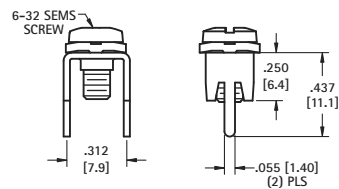

**PC MOUNT**

**CAT. NO. 8195-SEMS** (Screw Supplied Unassembled)

**CAT. NO. 7775-SEMS** (Screw Installed & Captivated)

**CAT. NO. 8198-SEMS** (Screw Supplied Unassembled)

**CAT. NO. 7778-SEMS** (Screw Installed & Captivated)



**PC MOUNT**

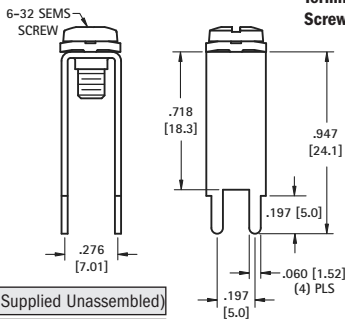

**SPECIFICATIONS**

**Terminal:** .032 (.81) Brass, Matte Tin Plate  
**Screw & Washer:** Steel, Nickel Plate

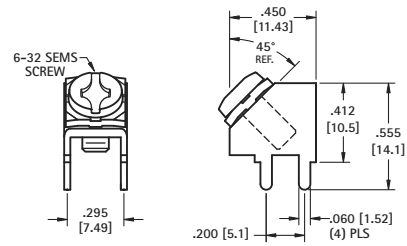

**PC MOUNT**

**CAT. NO. 7697-SEMS** (Screw Supplied Unassembled)

**CAT. NO. 7699-SEMS** (Screw Installed & Captivated)

**CAT. NO. 8189-SEMS** (Screw Supplied Unassembled)

**CAT. NO. 7702-SEMS** (Screw Installed & Captivated)

30 AMP



**SNAP-IN  
PC MOUNT**

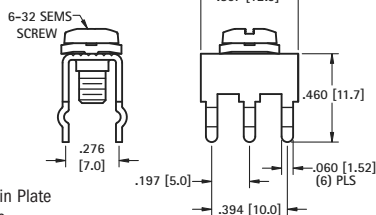

**SPECIFICATIONS**

**Terminal:** .032 (.81) Brass, Matte Tin Plate  
**Screw & Washer:** Steel, Nickel Plate

**CAT. NO. 8197-SEMS** (Screw Supplied Unassembled)

**CAT. NO. 8199-SEMS** (Screw Installed & Captivated)

SEMS Screw Terminals provide quick and secure attachment of wire leads. SEMS screw has captivated, free spinning lock washer, eliminated twisting of wire when tightening lead to terminal. Washer will rise with head of screw when unscrewed.

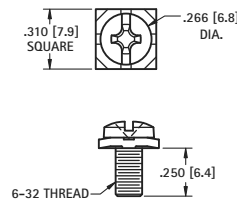

**SPECIFICATIONS**

**Screw & Washer:** Steel, Nickel Plate

**CAT. NO. 9920** (SEMS Screw Only)

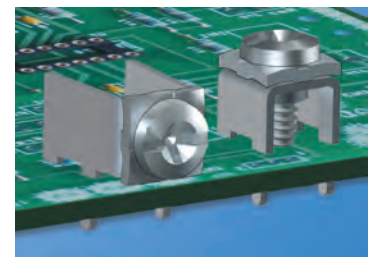

SEMS SCREW TERMINALS

# AMEYA360

Components Supply Platform

Authorized Distribution Brand :



Website :

Welcome to visit [www.ameya360.com](http://www.ameya360.com)

Contact Us :

➤ Address :

401 Building No.5, JiuGe Business Center, Lane 2301, Yishan Rd  
Minhang District, Shanghai , China

➤ Sales :

Direct +86 (21) 6401-6692

Email [amall@ameya360.com](mailto:amall@ameya360.com)

QQ 800077892

Skype [ameyasales1](#) [ameyasales2](#)

➤ Customer Service :

Email [service@ameya360.com](mailto:service@ameya360.com)

➤ Partnership :

Tel +86 (21) 64016692-8333

Email [mkt@ameya360.com](mailto:mkt@ameya360.com)