

MDS Medical AC-DC Open Frame

19Volt, 400Watt / MDS-400AUS19 B

400AUS19 B

Highlights & Features

- Safety Approvals to IEC 60601-1 3rd ed. & IEC 60950-1
- Risk management report available
- Low touch current (<0.1mA Normal & ,0.3mA single fault)
- Over-Voltage/Load/Temperature & Short Circuit protections
- 2 Million Hours MTBF
- 2 x MOPP (means of patient protection)
- 3 years warranty

Safety Standards



CB Certified for worldwide use

Model Number: MDS-400AUS19 B

Unit Weight: 910 grams (32.1 ounces)

Dimensions (W x L x H): 97x198x41.5 mm



General Description

The MDS series of embedded power supply comes with universal AC input at 90Vac to 264Vac. Other features include low touch current, risk management report available and the electric shock protection comply with 2 x MOPP. The MDS series is certified for EMC standards according to EN 55011 for industrial, scientific and medical (ISM) radio-frequency equipment and EN 55022 for Information Technology Equipment (ITE) radio-frequency equipment. In addition, only recognized Japanese capacitors are used.

The MDS series come with both medical and ITE safety approvals including UL/cUL/CCC/CE and CB certification and are fully compliant with RoHS Directive 2011/65/EU for environmental protection.

Model Information

Medical AC-DC Open Frame

Model Number	Input Voltage Range	Output Voltage	Conversion Current Output	Forced Air Current Output
MDS-400AUS19 B	90-264Vac	19Vdc	15.8A	21.1A*

*21.1A with 200LFM force air, 15.8A for convection

Model Numbering

MDS	-	400	AUS	19	B
Delta Medical power Supply		Max wattage in the product series. Maybe lower at some voltage. 400 → 400W	Family Code	Output Voltage Single Output: 19 for 19V	

MDS Medical AC-DC Open Frame

19Volt, 400Watt / MDS-400AUS19 B

Specifications

Input Ratings / Characteristics

Nominal Input Voltage	100-240Vac
Input Voltage Range	90-264Vac
Nominal Input Frequency	50-60Hz
Input Frequency Range	47-63Hz
Input Current (max)	5.5A @ 90Vac, 2.7A @ 264Vac
Efficiency (typ.)	91.38%, Reference Fig.1
Standby Power (max)	1.2W
Inrush Current (typ.)	60A @ 115Vac, 60A @ 230Vac
Touch Current (max)	0.1mA @ 240Vac NC ¹⁾ , 0.3mA @ 264Vac SFC ²⁾

1) NC: normal condition

2) SFC: single fault condition

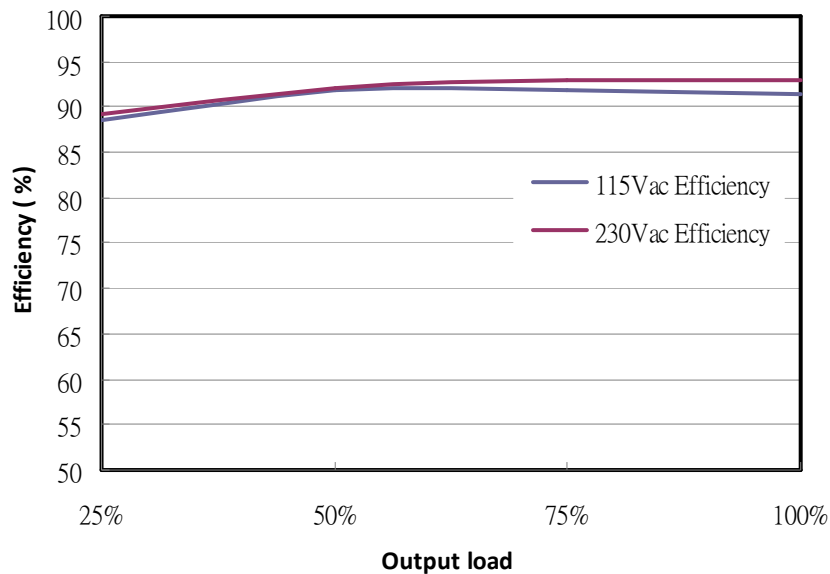

Fig.1 Efficiency versus output load

Output Ratings / Characteristics

Nominal Output Voltage	19Vdc
Output Voltage Tolerance	± 2%
Output Current	21.1A with 200LFM force air, 15.8A for convection
Output Power	400W with 200LFM force air, 300W for convection
Line Regulation (max)	±0.5%
Fan Supply	12V 0.25A
Remote Sense	Compensates for up to 500mV voltage drop
Ripple & Noise (typ.)	100.8 mV pk-pk @ Full load, Reference Fig. 2,
Hold-up Time(min)	12ms @115Vac

MDS Medical AC-DC Open Frame

19Volt, 400Watt / MDS-400AUS19 B

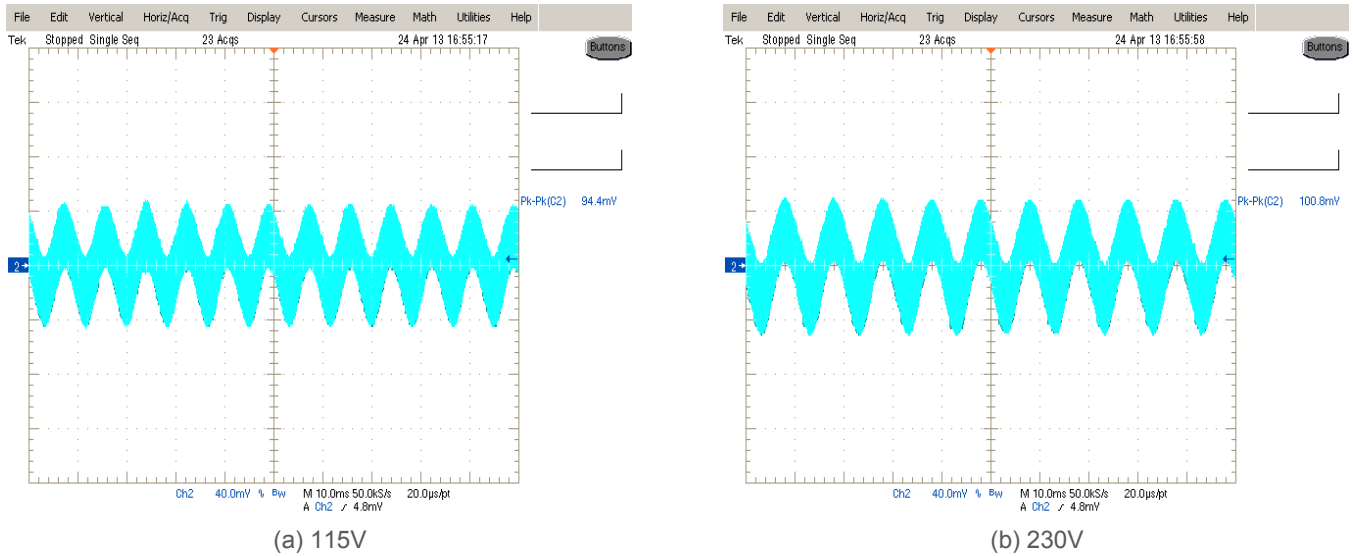
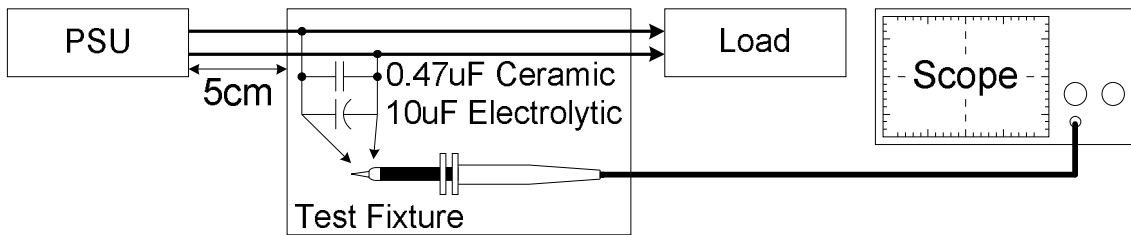

Fig. 2 Ripple & Noise example, 20MHz BW

Ripple & Noise measurement circuit



Mechanical

Case Chassis	AL1100F(+Electrocoat)	
Case Cover	NA	
Dimensions (W x Lx H)	97.0x198.0x41.5 mm	
Unit Weight	910 grams (32.1 ounces)	
Power De-rating	See Fig. 3 (400W with forced air flow)	
Terminal	Input	DECA: T33-BM1103A301
	Output	DECA: T33-BM1104A301
DC Fan	Output	JWT: A2508WV0-2P

Environment

Surrounding Air Temperature	Operating	-10°C to +70°C
	Storage	-40°C to +85°C
Power De-rating		-10°C to +50°C 100% load 50°C to 70°C with load de-rate power
Operating Humidity		10-95% RH (Non-Condensing)
Operating Altitude		3,000 meters
Shock Test (Non-Operating)		50G, 11ms, 3 shocks for each direction
Vibration (Operating)		5-500Hz, 2.09Grms, 20 minute for each three axis

MDS Medical AC-DC Open Frame

19Volt, 400Watt / MDS-400AUS19 B

Protections

Overvoltage (max)	150%, Latch Mode
Over load / Over current (max)	130% of rated load current, Hiccup Mode, (Non-Latching, Auto-Recovery)
Over Temperature	Hiccup Mode, (Non-Latching, Auto-Recovery)
Short Circuit	Hiccup Mode, (Non-Latching, Auto-Recovery)
Protection Against Shock	Class I with PE* connection

*PE: Protective Earth

Reliability Data

MTBF (typ.)	2 Million Hrs based on Telecordia SR-332
-------------	--

Safety Standards / Directives

Medical Safety	IEC60601-1: (Ed.3,2005), EN60601-1:2006, CAN/CSA-C22.2 No. 60601-1:08, ANSI/AAMI ES60601-1: (Ed.3,2005)	
ITE Safety	IEC60950-1 (Ed.2,2005), GB4943.1-2011, GB9254-2008, GB17625.1-2003	
CE	MDD Directive 93/42/EEC	
Material and Parts	RoHS Directive 2011/65/EU Compliant	
Galvanic Isolation	Input to Output	4000 Vac
	Input to Ground	1500 Vac
	Output to Ground	500 Vac

MDS Medical AC-DC Open Frame

19Volt, 400Watt / MDS-400AUS19 B

EMC

EMC / Emissions		EN55011, EN55022, FCC Title 47: Class B
Immunity to		
Voltage Flicker	IEC61000-3-3	Meet the requirement
Electrostatic Discharge	IEC61000-4-2	Level 3 Criteria A ¹⁾ Air Discharge: 8kV Contact Discharge: 6kV
Electrical Fast Transient / Burst	IEC61000-4-4	Level 3 Criteria A ¹⁾ 2kV
Surge	IEC61000-4-5	Level 3 Criteria A ¹⁾ Common Mode ²⁾ : 2kV Differential Mode ³⁾ : 1kV
Conducted	IEC61000-4-6	Level 2 Criteria A ¹⁾ 150kHz-80MHz, 3Vrms
Power Frequency Magnetic Fields	IEC61000-4-8	Criteria A ¹⁾ Magnetic field strength 3A/Meter
Voltage Dips	IEC61000-4-11	30% 10ms Criteria A ; 60% 100ms and 100% 5000ms Criteria B
Harmonic current emissions	IEC61000-3-2	Meet Class D limit

1) Criteria A: Normal performance within the specification limits
 2) Asymmetrical: Common mode (Line to earth)
 3) Symmetrical: Differential mode (Line to line)

Block Diagram

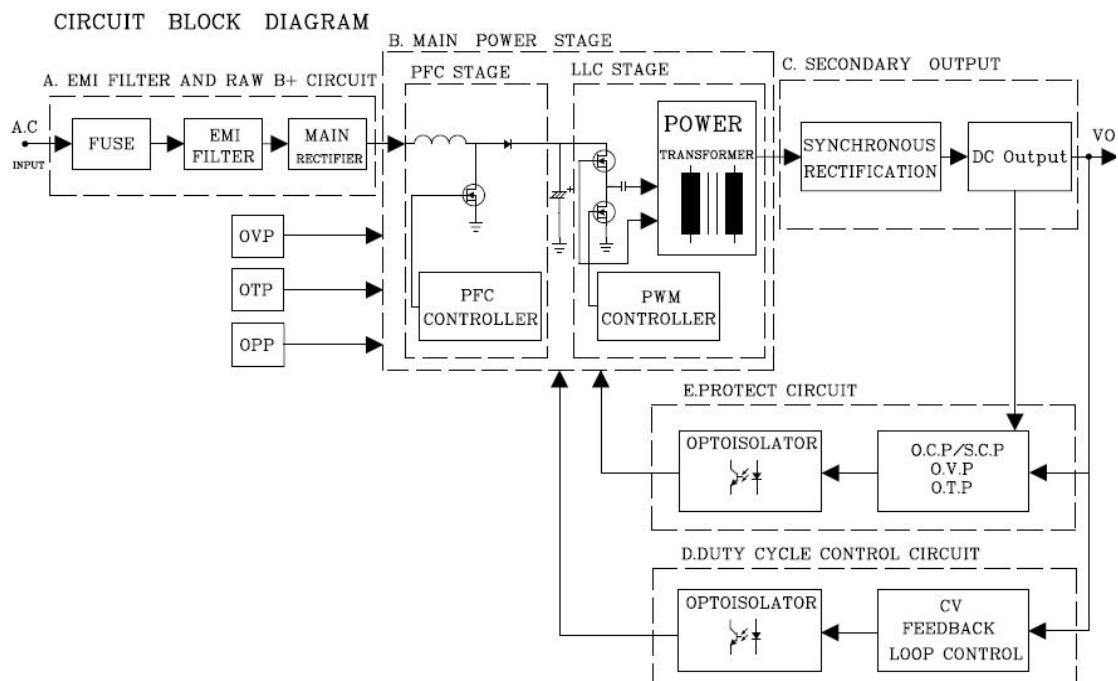

MDS Medical AC-DC Open Frame

19Volt, 400Watt / MDS-400AUS19 B

Dimensions

W x L x H: 97 x 198 x 41.5 mm



(X4)REFER TO DETAIL "A"
L=5.0mm MAX.

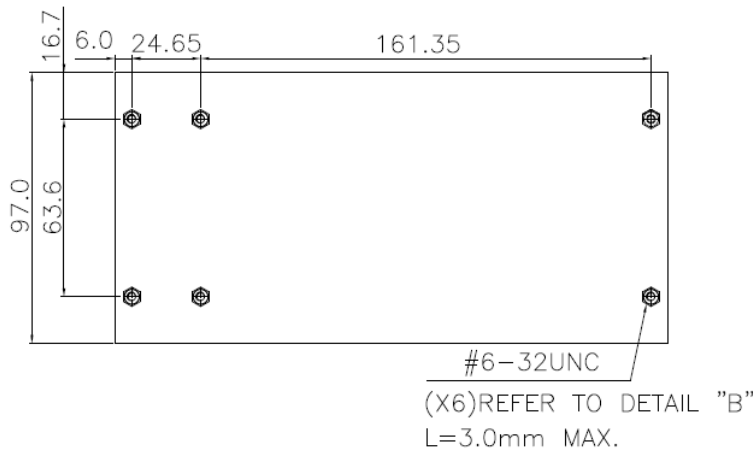
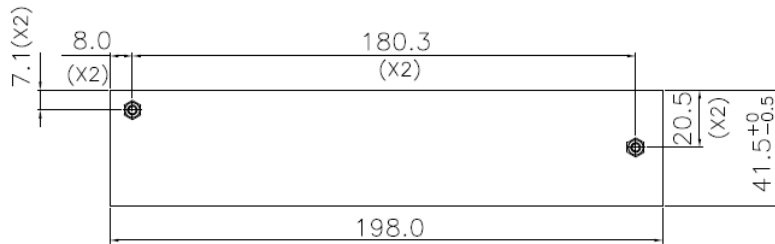
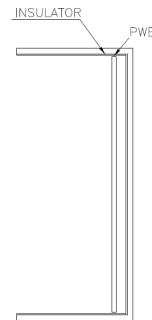
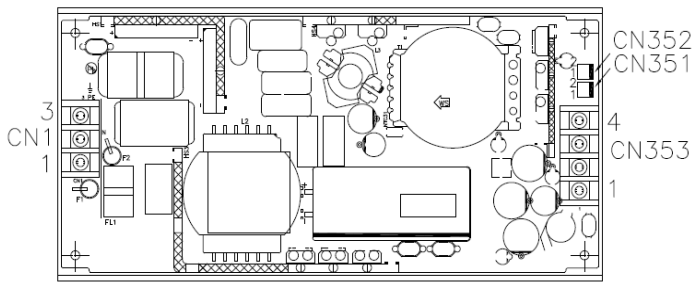

(X6)REFER TO DETAIL "B"
L=3.0mm MAX.

ITEM	PIN NAME	FUNCTION
CN1	1	L
	2	N
	3	PE
CN353	1	V+
	2	
	3	V-
	4	
CN352	1	REMOTE SENSE V-
	2	REMOTE SENSE V+
CN351	1	GND (12V/0.25A)
	2	12V

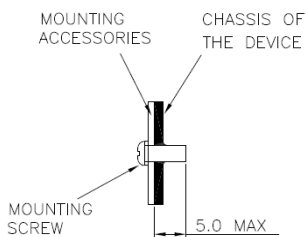

DETAIL "A"

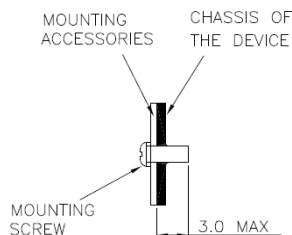

DETAIL "B"

Notes

- Dimensions are in mm
- DIMENSION TOLERANCE IS ±0.5

MDS Medical AC-DC Open Frame

19Volt, 400Watt / MDS-400AUS19 B

Power De-rating

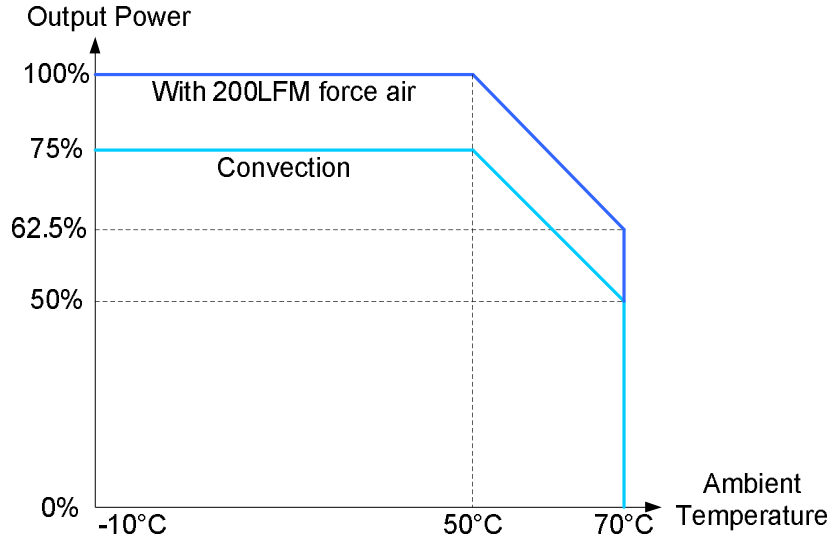

Fig. 3

Functions

Start-up Time

The time required for the output voltage (V_o) to reach 90% of its set value, after the input AC voltage is applied.

Rise Time

The time required for the output voltage (V_o) to change from 10% to 90% of its steady state value.

Hold-up Time

Hold up time is the time when the AC input collapses and output voltage retains regulation for a certain period of time. The time required for the output to reach 95% of its set value, after the input voltage is removed.

■ Graph illustrating the Start-up Time, Rise Time, and Hold-up Time

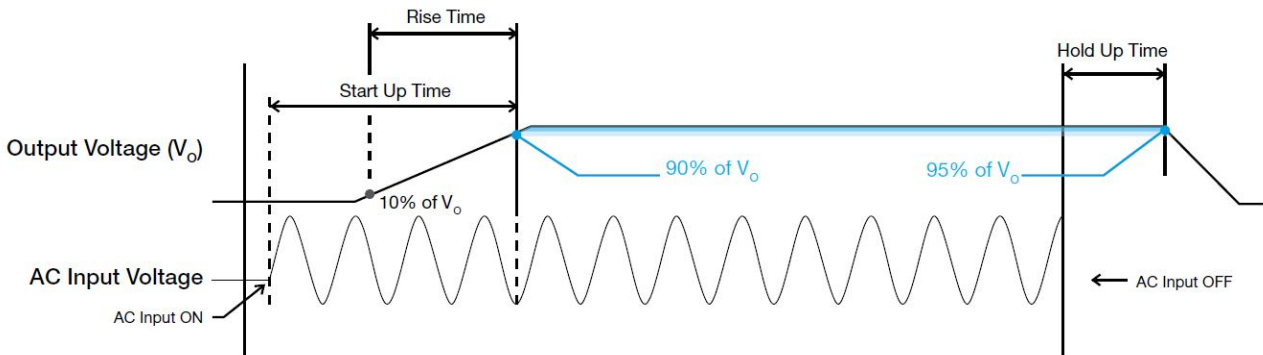

MDS Medical AC-DC Open Frame

19Volt, 400Watt / MDS-400AUS19 B

Dynamic Response

The power supply output voltage will remain within $\pm 3\%$ of its steady state value, when subjected to a dynamic load change from 50 to 100% of its rated current.

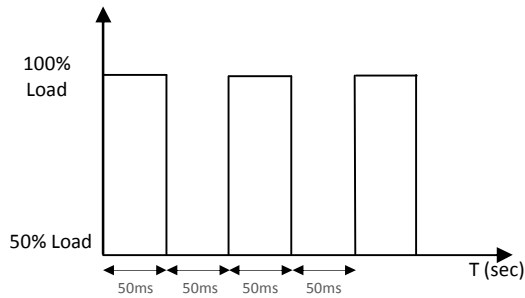

Inrush Current

Inrush current is the input current that occurs when the input voltage is first applied. For AC input voltages, the maximum peak value of inrush current will occur during the first half cycle of the applied AC voltage. This peak value decreases exponentially during subsequent cycles of AC voltage.

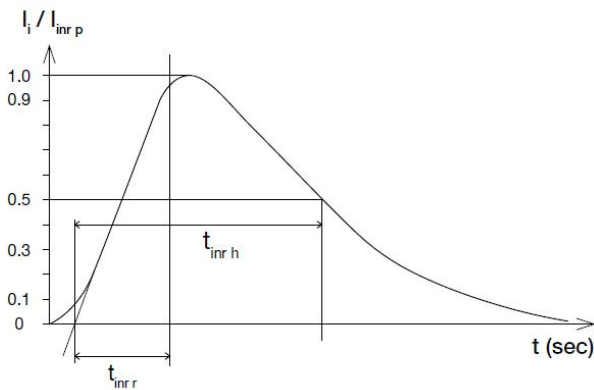

Overvoltage Protection

The power supply's overvoltage circuit will be activated when its internal feedback circuit fails. The output voltage shall not exceed its specifications defined on Page 3 under "Protections". Power supply will hiccup mode, and require removal/re-application of input AC voltage in order to restart.

Short Circuit Protection

The power supply's output OLP/OCP function also provides protection against short circuits. When a short circuit is applied, the output current will operate in "Hiccup mode", as shown in the illustration in the OLP/OCP section on this page. The power

supply will return to normal operation after the short circuit is removed.

Overload & Over current Protections

The power supply's Overload (OLP) and Over current (OCP) Protections will be activated when output current is between 110% and 130% of I_o (Max load). Upon such an occurrence, V_o will start to drop. Once the power supply has reached its maximum power limit, the protection will be activated, and the power supply will go into "Hiccup mode" (Auto-Recovery). The power supply will recover once the fault condition causing the OLP and OCP is removed and I_o is back within the specified limit.

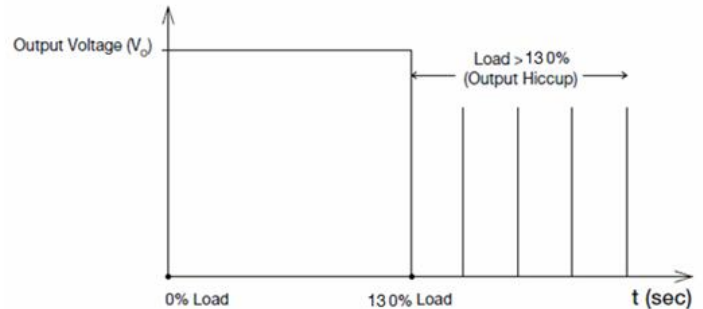

Additionally, if the I_o is $< 130\%$ but $> 110\%$ for a prolonged period of time (depending on the load), the Over Temperature Protection (OTP) will be activated due to high temperature on critical components. The power supply will then go into hiccup mode until the fault is removed; and, the input voltage is removed, then reapplied.

Over Temperature Protection

As mentioned above, the power supply also has Over Temperature Protection (OTP). This is activated when the overload condition persists for an extended duration and the output current is below the overload trigger point but $> 100\%$ load. In the event of a higher operating condition at 100% load, the power supply will run into OTP when the surrounding air temperature is higher than the operating temperature. When activated, the output voltage will go into hiccup mode until the input voltage is removed; then, reapplied, and the surrounding air temperature drops to its normal operating temperature.

MDS Medical AC-DC Open Frame

19Volt, 400Watt / MDS-400AUS19 B

Certificate



All Delta Medical Power products conform to the European directive 2011/65/EU. RoHS is the abbreviation for "Restriction of the use of certain hazardous substances."



Delta has been certified as meeting the requirement of ISO 13485: 2003 and EN ISO 13485:2012 for the design and manufacture of switching power supply and adaptor for medical device.



Delta is approved for the UL Total Certification Program (TCP) approved client laboratory for IEC62368-1. Delta also has participated UL Client Test Data Program (CTDP) for IEC 60601.

AMEYA360

Components Supply Platform

Authorized Distribution Brand :



Website :

Welcome to visit www.ameya360.com

Contact Us :

➤ Address :

401 Building No.5, JiuGe Business Center, Lane 2301, Yishan Rd
Minhang District, Shanghai , China

➤ Sales :

Direct +86 (21) 6401-6692

Email amall@ameya360.com

QQ 800077892

Skype [ameyasales1](#) [ameyasales2](#)

➤ Customer Service :

Email service@ameya360.com

➤ Partnership :

Tel +86 (21) 64016692-8333

Email mkt@ameya360.com