



Micro Commercial Components



Micro Commercial Components  
20736 Marilla Street Chatsworth  
CA 91311  
Phone: (818) 701-4933  
Fax: (818) 701-4939

# MMBT2222A

## NPN General Purpose Amplifier

### Features

- Halogen free available upon request by adding suffix "-HF"
- Surface Mount SOT-23 Package
- Capable of 350mWatts of Power Dissipation,  $I_C=600mA$
- Operating and Storage Junction Temperature:  $-55^{\circ}C$  to  $+150^{\circ}C$
- Thermal resistance, Junction to Ambient:  $500^{\circ}C/W$
- Epoxy meets UL 94 V-0 flammability rating
- Moisture Sensitivity Level 1
- Marking: 1P
- Lead Free Finish/RoHS Compliant("P" Suffix designates Compliant)

### Electrical Characteristics @ 25°C Unless Otherwise Specified

Symbol	Parameter	Min	Max	Units
<b>OFF CHARACTERISTICS</b>				
$V_{(BR)CEO}$	Collector-Emitter Breakdown Voltage* ( $I_C=10mA$ , $I_B=0$ )	40		Vdc
$V_{(BR)CBO}$	Collector-Base Breakdown Voltage ( $I_C=10\mu A$ , $I_E=0$ )	75		Vdc
$V_{(BR)EBO}$	Emitter-Base Breakdown Voltage ( $I_E=10\mu A$ , $I_C=0$ )	6.0		Vdc
$I_{CEX}$	Collector Cutoff Current ( $V_{CE}=60Vdc$ , $V_{BE}=3.0Vdc$ )		10	nAdc

### ON CHARACTERISTICS

$\beta_{FE}$	DC Current Gain* ( $I_C=0.1mA$ , $V_{CE}=10Vdc$ ) ( $I_C=1.0mA$ , $V_{CE}=10Vdc$ ) ( $I_C=10mA$ , $V_{CE}=10Vdc$ ) ( $I_C=150mA$ , $V_{CE}=10Vdc$ ) ( $I_C=150mA$ , $V_{CE}=1.0Vdc$ ) ( $I_C=500mA$ , $V_{CE}=10Vdc$ )	35	300	Vdc
		50		
		75		
		100		
		40		
$V_{CE(sat)}$	Collector-Emitter Saturation Voltage ( $I_C=150mA$ , $I_B=15mA$ ) ( $I_C=500mA$ , $I_B=50mA$ )		0.3 1.0	Vdc
$V_{BE(sat)}$	Base-Emitter Saturation Voltage ( $I_C=150mA$ , $I_B=15mA$ ) ( $I_C=500mA$ , $I_B=50mA$ )	0.6	1.2 2.0	Vdc

### SMALL-SIGNAL CHARACTERISTICS

$f_T$	Current Gain-Bandwidth Product ( $I_C=20mA$ , $V_{CE}=20Vdc$ , $f=100MHz$ )	300	MHz
$C_{obo}$	Output Capacitance ( $V_{CB}=10Vdc$ , $I_E=0$ , $f=1.0MHz$ )	8.0	pF
$C_{ibo}$	Input Capacitance ( $V_{BE}=0.5Vdc$ , $I_C=0$ , $f=1.0MHz$ )	25	pF
NF	Noise Figure ( $I_C=100\mu A$ , $V_{CE}=10Vdc$ , $R_S=1.0k\Omega$ , $f=1.0kHz$ )	4.0	dB

### SWITCHING CHARACTERISTICS

$t_d$	Delay Time	( $V_{CC}=30Vdc$ , $V_{BE}=0.5Vdc$ )	10	ns
$t_r$	Rise Time	( $I_C=150mA$ , $I_{B1}=15mA$ )	25	ns
$t_s$	Storage Time	( $V_{CC}=30Vdc$ , $I_C=150mA$ )	225	ns
$t_f$	Fall Time	( $I_{B1}=I_{B2}=15mA$ )	60	ns

\*Pulse Width  $\leq 300\mu s$ , Duty Cycle  $\leq 2.0\%$

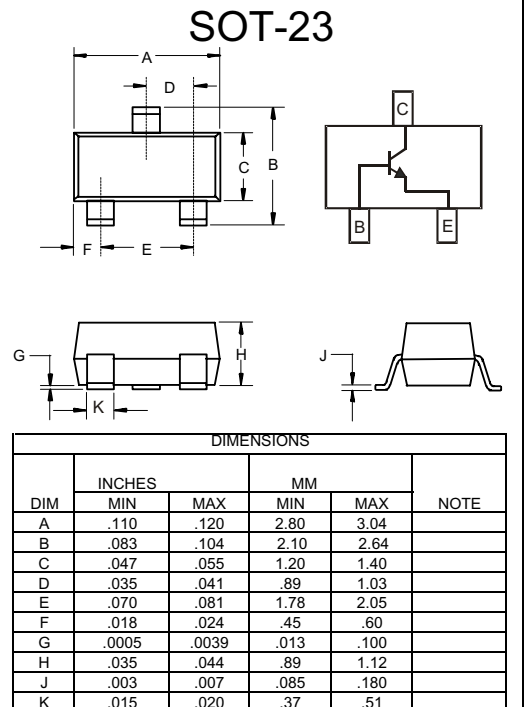

### Suggested Solder Pad Layout

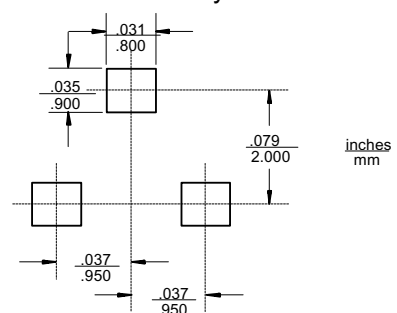

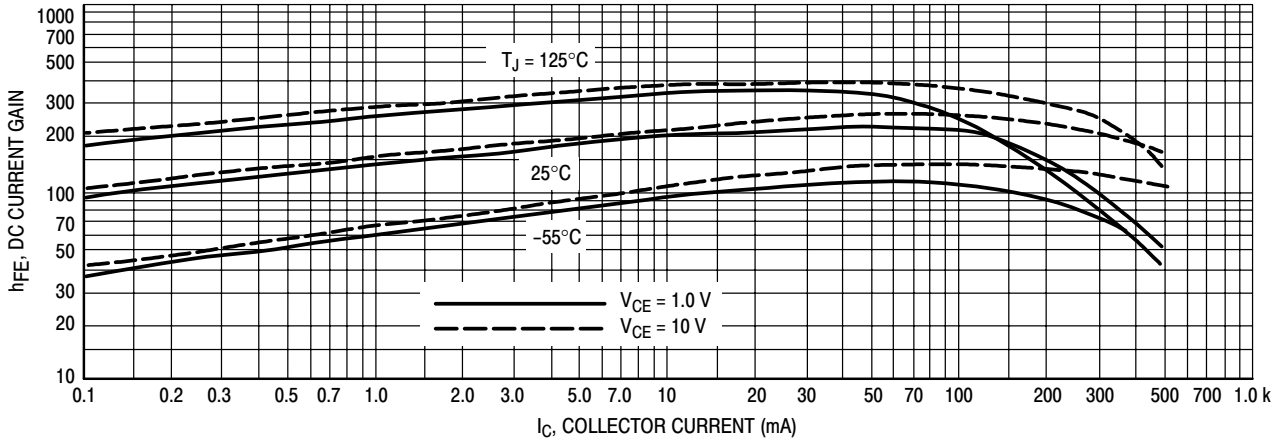

Figure 1. DC Current Gain

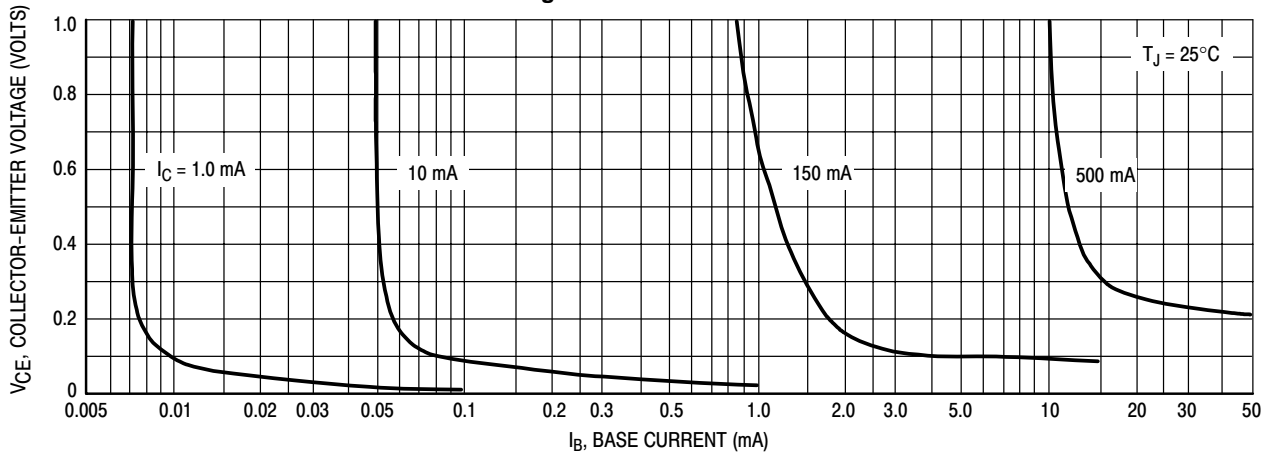

Figure 2. Collector Saturation Region

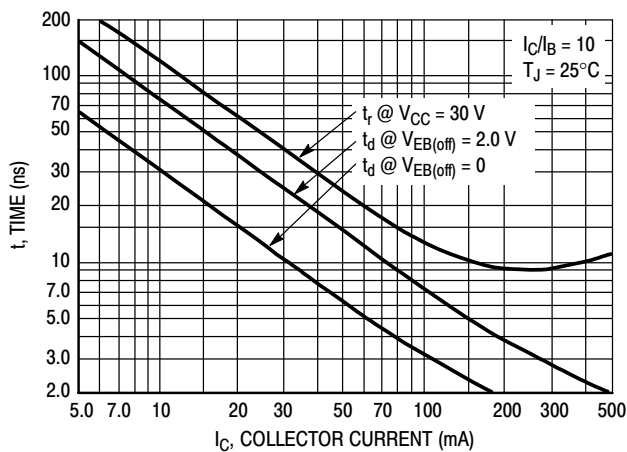

Figure 3. Turn-On Time

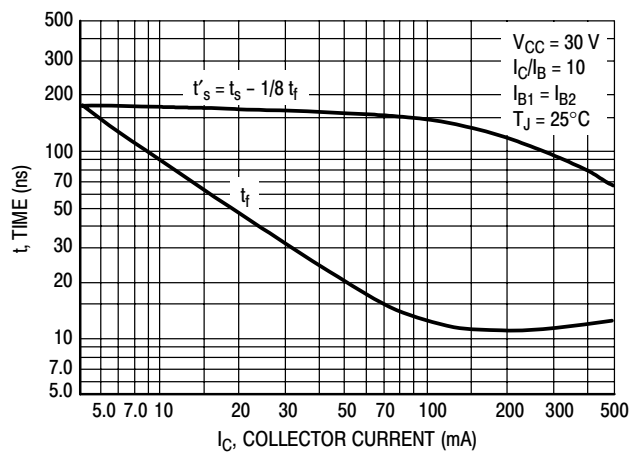

Figure 4. Turn-Off Time

# MMBT2222A

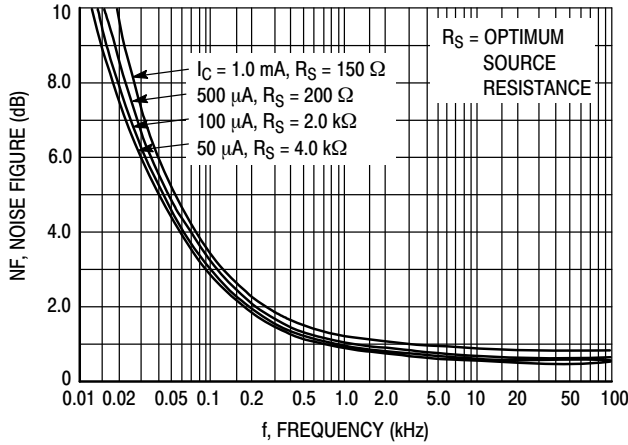

Figure 5. Frequency Effects

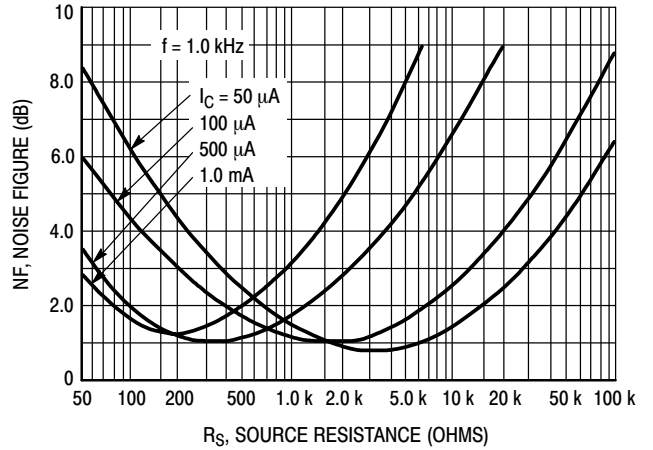

Figure 6. Source Resistance Effects

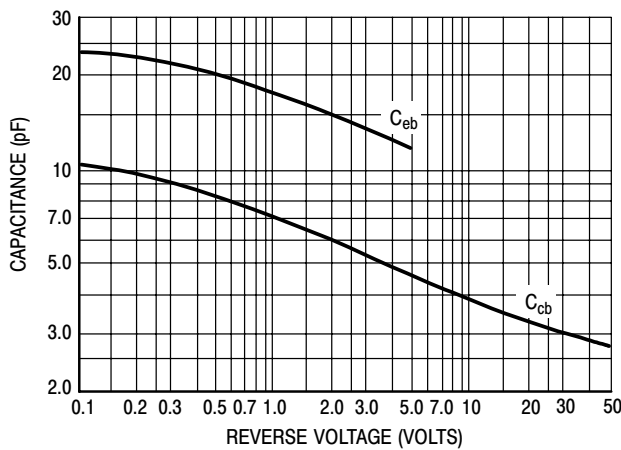

Figure 7. Capacitances

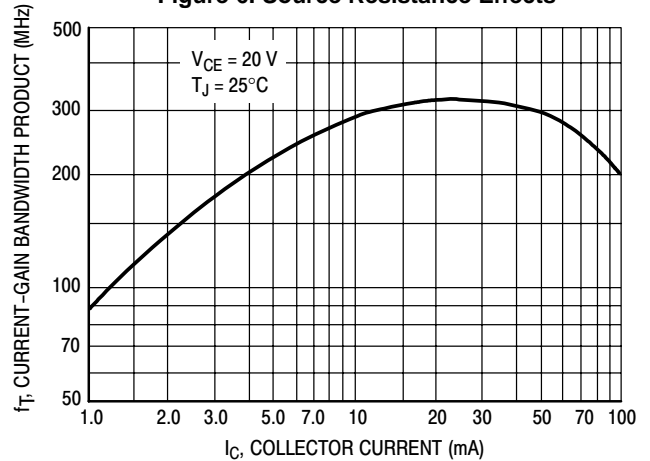

Figure 8. Current-Gain Bandwidth Product

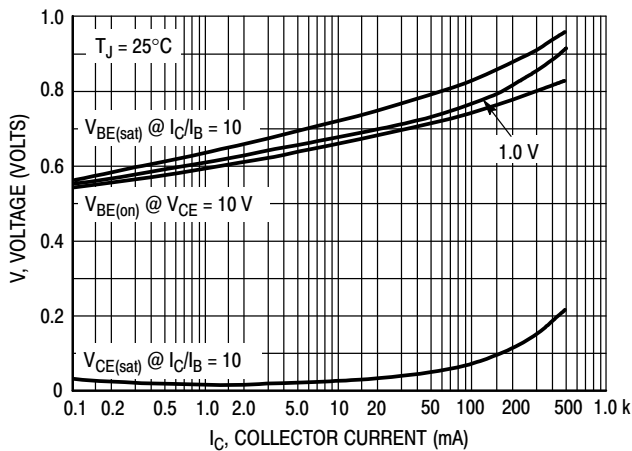

Figure 9. "On" Voltages

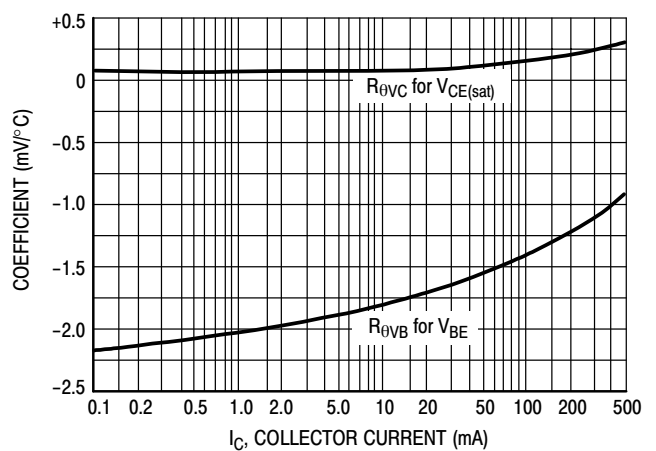

Figure 10. Temperature Coefficients



Micro Commercial Components

### Ordering Information :

Device	Packing
Part Number-TP	Tape&Reel: 3Kpcs/Reel

Note : Adding "-HF" suffix for halogen free, eg. Part Number-TP-HF

#### \*\*\*IMPORTANT NOTICE\*\*\*

**Micro Commercial Components Corp.** reserves the right to make changes without further notice to any product herein to make corrections, modifications, enhancements, improvements, or other changes. **Micro Commercial Components Corp.** does not assume any liability arising out of the application or use of any product described herein; neither does it convey any license under its patent rights, nor the rights of others. The user of products in such applications shall assume all risks of such use and will agree to hold **Micro Commercial Components Corp.** and all the companies whose products are represented on our website, harmless against all damages.

#### \*\*\*LIFE SUPPORT\*\*\*

MCC's products are not authorized for use as critical components in life support devices or systems without the express written approval of Micro Commercial Components Corporation.

#### \*\*\*CUSTOMER AWARENESS\*\*\*

Counterfeiting of semiconductor parts is a growing problem in the industry. Micro Commercial Components (MCC) is taking strong measures to protect ourselves and our customers from the proliferation of counterfeit parts. MCC strongly encourages customers to purchase MCC parts either directly from MCC or from Authorized MCC Distributors who are listed by country on our web page cited below. Products customers buy either from MCC directly or from Authorized MCC Distributors are genuine parts, have full traceability, meet MCC's quality standards for handling and storage. **MCC will not provide any warranty coverage or other assistance for parts bought from Unauthorized Sources.** MCC is committed to combat this global problem and encourage our customers to do their part in stopping this practice by buying direct or from authorized distributors.

[www.mccsemi.com](http://www.mccsemi.com)

# AMEYA360

## Components Supply Platform

### Authorized Distribution Brand :



### Website :

Welcome to visit [www.ameya360.com](http://www.ameya360.com)

### Contact Us :

#### ➤ Address :

401 Building No.5, JiuGe Business Center, Lane 2301, Yishan Rd  
Minhang District, Shanghai , China

#### ➤ Sales :

Direct +86 (21) 6401-6692

Email [amall@ameya360.com](mailto:amall@ameya360.com)

QQ 800077892

Skype [ameyasales1](#) [ameyasales2](#)

#### ➤ Customer Service :

Email [service@ameya360.com](mailto:service@ameya360.com)

#### ➤ Partnership :

Tel +86 (21) 64016692-8333

Email [mkt@ameya360.com](mailto:mkt@ameya360.com)