

FDMC8200S

Dual N-Channel PowerTrench® MOSFET 30 V, 10 mΩ, 20 mΩ

Features

Q1: N-Channel

- Max $r_{DS(on)}$ = 20 mΩ at $V_{GS} = 10$ V, $I_D = 6$ A
- Max $r_{DS(on)}$ = 32 mΩ at $V_{GS} = 4.5$ V, $I_D = 5$ A

Q2: N-Channel

- Max $r_{DS(on)}$ = 10 mΩ at $V_{GS} = 10$ V, $I_D = 8.5$ A
- Max $r_{DS(on)}$ = 13.5 mΩ at $V_{GS} = 4.5$ V, $I_D = 7.2$ A
- RoHS Compliant



General Description

This device includes two specialized N-Channel MOSFETs in a due power33(3mm X 3mm MLP) package. The switch node has been internally connected to enable easy placement and routing of synchronous buck converters. The control MOSFET (Q1) and synchronous MOSFET (Q2) have been designed to provide optimal power efficiency.

Applications

- Mobile Computing
- Mobile Internet Devices
- General Purpose Point of Load

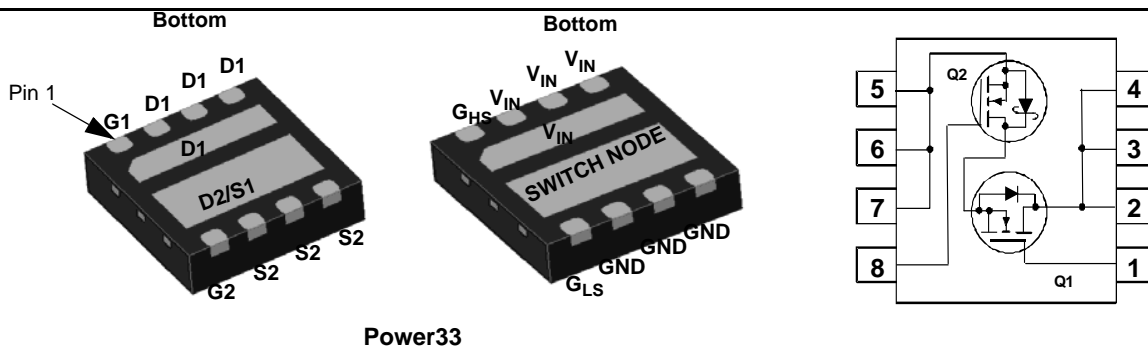

MOSFET Maximum Ratings $T_C = 25^\circ\text{C}$ unless otherwise noted

Symbol	Parameter	Q1	Q2	Units
V_{DS}	Drain to Source Voltage	30	30	V
V_{GS}	Gate to Source Voltage (Note 4)	± 20	± 20	V
I_D	Drain Current -Continuous (Package limited) $T_C = 25^\circ\text{C}$	18	13	A
	-Continuous (Silicon limited) $T_C = 25^\circ\text{C}$	23	46	
	-Continuous $T_A = 25^\circ\text{C}$	6 ^{1a}	8.5 ^{1b}	
	-Pulsed	40	27	
E_{AS}	Single Pulse Avalanche Energy (Note 3)	12	32	
P_D	Power Dissipation for Single Operation $T_A = 25^\circ\text{C}$	1.9 ^{1a}	2.5 ^{1b}	W
	Power Dissipation for Single Operation $T_A = 25^\circ\text{C}$	0.7 ^{1c}	1.0 ^{1d}	
T_J, T_{STG}	Operating and Storage Junction Temperature Range	-55 to +150		$^\circ\text{C}$

Thermal Characteristics

$R_{\theta JA}$	Thermal Resistance, Junction to Ambient	65 ^{1a}	50 ^{1b}	$^\circ\text{C/W}$
$R_{\theta JA}$	Thermal Resistance, Junction to Ambient	180 ^{1c}	125 ^{1d}	
$R_{\theta JC}$	Thermal Resistance, Junction to Case	7.5	4.2	

Package Marking and Ordering Information

Device Marking	Device	Package	Reel Size	Tape Width	Quantity
FDMC8200S	FDMC8200S	Power 33	13"	12 mm	3000 units

Electrical Characteristics $T_J = 25^\circ\text{C}$ unless otherwise noted

Symbol	Parameter	Test Conditions	Type	Min	Typ	Max	Units
--------	-----------	-----------------	------	-----	-----	-----	-------

Off Characteristics

BV_{DSS}	Drain to Source Breakdown Voltage	$I_D = 250 \mu\text{A}, V_{GS} = 0 \text{ V}$ $I_D = 1\text{mA}, V_{GS} = 0 \text{ V}$	Q1 Q2	30 30			V
$\frac{\Delta BV_{DSS}}{\Delta T_J}$	Breakdown Voltage Temperature Coefficient	$I_D = 250 \mu\text{A}$, referenced to 25°C $I_D = 1\text{mA}$, referenced to 25°C	Q1 Q2		14 13		mV/ $^\circ\text{C}$
I_{DSS}	Zero Gate Voltage Drain Current	$V_{DS} = 24 \text{ V}, V_{GS} = 0 \text{ V}$	Q1 Q2			1 500	μA
I_{GSS}	Gate to Source Leakage Current	$V_{GS} = \pm 20 \text{ V}, V_{DS} = 0 \text{ V}$	Q1 Q2			100 100	nA

On Characteristics

$V_{GS(th)}$	Gate to Source Threshold Voltage	$V_{GS} = V_{DS}, I_D = 250 \mu\text{A}$ $V_{GS} = V_{DS}, I_D = 1\text{mA}$	Q1 Q2	1.0 1.0	2.3 2.0	3.0 3.0	V
$\frac{\Delta V_{GS(th)}}{\Delta T_J}$	Gate to Source Threshold Voltage Temperature Coefficient	$I_D = 250 \mu\text{A}$, referenced to 25°C $I_D = 1\text{mA}$, referenced to 25°C	Q1 Q2		-5 -6		mV/ $^\circ\text{C}$
$r_{DS(on)}$	Static Drain to Source On Resistance	$V_{GS} = 10 \text{ V}, I_D = 6 \text{ A}$ $V_{GS} = 4.5 \text{ V}, I_D = 5 \text{ A}$ $V_{GS} = 10 \text{ V}, I_D = 6 \text{ A}, T_J = 125^\circ\text{C}$	Q1		16 24 22	20 32 28	m Ω
		$V_{GS} = 10 \text{ V}, I_D = 8.5 \text{ A}$ $V_{GS} = 4.5 \text{ V}, I_D = 7.2 \text{ A}$ $V_{GS} = 10 \text{ V}, I_D = 8.5 \text{ A}, T_J = 125^\circ\text{C}$	Q2		7.8 10.3 11.4	10.0 13.5 13.1	
g_{FS}	Forward Transconductance	$V_{DD} = 5 \text{ V}, I_D = 6 \text{ A}$ $V_{DD} = 5 \text{ V}, I_D = 8.5 \text{ A}$	Q1 Q2		29 43		S

Dynamic Characteristics

C_{iss}	Input Capacitance	$V_{DS} = 15 \text{ V}, V_{GS} = 0 \text{ V}, f = 1 \text{ MHz}$	Q1 Q2		495 1080	660 1436	pF
C_{oss}	Output Capacitance		Q1 Q2		145 373	195 495	pF
C_{riss}	Reverse Transfer Capacitance		Q1 Q2		20 35	30 52	pF
R_g	Gate Resistance		Q1 Q2	0.2 0.2	1.4 1.2	4.2 3.6	Ω

Switching Characteristics

$t_{d(on)}$	Turn-On Delay Time	Q1 $V_{DD} = 15 \text{ V}, I_D = 1 \text{ A},$ $V_{GS} = 10 \text{ V}, R_{GEN} = 6 \Omega$	Q1 Q2		11 7.6	20 15	ns
t_r	Rise Time		Q1 Q2		3.1 1.8	10 10	ns
$t_{d(off)}$	Turn-Off Delay Time	Q2 $V_{DD} = 15 \text{ V}, I_D = 1 \text{ A},$ $V_{GS} = 10 \text{ V}, R_{GEN} = 6 \Omega$	Q1 Q2		35 21	56 34	ns
t_f	Fall Time		Q1 Q2		1.3 8.5	10 17	ns
$Q_{g(TOT)}$	Total Gate Charge	$V_{GS} = 0 \text{ V to } 10 \text{ V}$	Q1 Q2		7.3 15.7	10 22	nC
$Q_{g(TOT)}$	Total Gate Charge	$V_{GS} = 0 \text{ V to } 4.5 \text{ V}$			Q1 Q2		3.1 7.2
Q_{gs}	Gate to Source Charge	Q2 $V_{DD} = 15 \text{ V}$ $I_D = 8.5 \text{ A}$	Q1 Q2		1.8 3		nC
Q_{gd}	Gate to Drain "Miller" Charge		Q1 Q2		1 1.9		nC

Electrical Characteristics $T_J = 25^\circ\text{C}$ unless otherwise noted

Symbol	Parameter	Test Conditions	Type	Min	Typ	Max	Units
Drain-Source Diode Characteristics							
V_{SD}	Source-Drain Diode Forward Voltage	$V_{GS} = 0\text{ V}, I_S = 6\text{ A}$ (Note 2)	Q1		0.8	1.2	V
		$V_{GS} = 0\text{ V}, I_S = 8.5\text{ A}$ (Note 2)	Q2		0.8	1.2	
		$V_{GS} = 0\text{ V}, I_S = 1.3\text{ A}$ (Note 2)	Q2		0.6	0.8	
t_{rr}	Reverse Recovery Time	Q1 $I_F = 6\text{ A}, di/dt = 100\text{ A/s}$	Q1		13	24	ns
		Q2			20	32	
Q_{rr}	Reverse Recovery Charge	Q2 $I_F = 8.5\text{ A}, di/dt = 300\text{ A/s}$	Q1		2.3	10	nC
			Q2		15	24	

Notes:

1. $R_{\theta JA}$ is determined with the device mounted on a 1in² pad 2 oz copper pad on a 1.5 x 1.5 in. board of FR-4 material. $R_{\theta JC}$ is guaranteed by design while $R_{\theta CA}$ is determined by the user's board design.



a. 65 °C/W when mounted on a 1 in² pad of 2 oz copper



b. 50 °C/W when mounted on a 1 in² pad of 2 oz copper

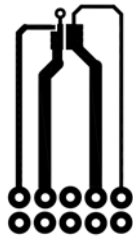

c. 180 °C/W when mounted on a minimum pad of 2 oz copper

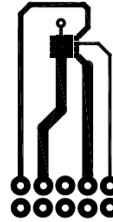

d. 125 °C/W when mounted on a minimum pad of 2 oz copper

2. Pulse Test: Pulse Width < 300 μs , Duty cycle < 2.0%.

3. Starting Q1: $T = 25^\circ\text{C}$, $L = 1\text{ mH}$, $I = 5\text{ A}$, $V_{gs} = 10\text{V}$, $V_{dd} = 27\text{V}$, 100% test at $L = 3\text{ mH}$, $I = 4\text{ A}$; Q2: $T = 25^\circ\text{C}$, $L = 1\text{ mH}$, $I = 8\text{ A}$, $V_{gs} = 10\text{V}$, $V_{dd} = 27\text{V}$, 100% test at $L = 3\text{ mH}$, $I = 3.2\text{ A}$.

4. As an N-ch device, the negative V_{gs} rating is for low duty cycle pulse occurrence only. No continuous rating is implied.

Typical Characteristics (Q1 N-Channel) $T_J = 25^\circ\text{C}$ unless otherwise noted

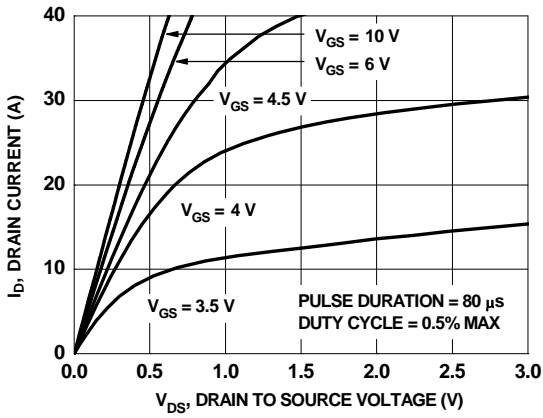

Figure 1. On Region Characteristics

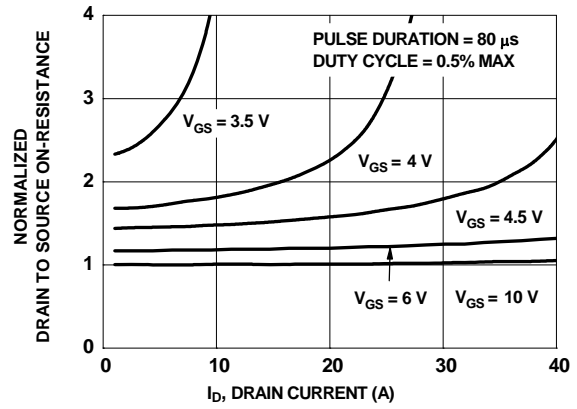

Figure 2. Normalized On-Resistance vs Drain Current and Gate Voltage

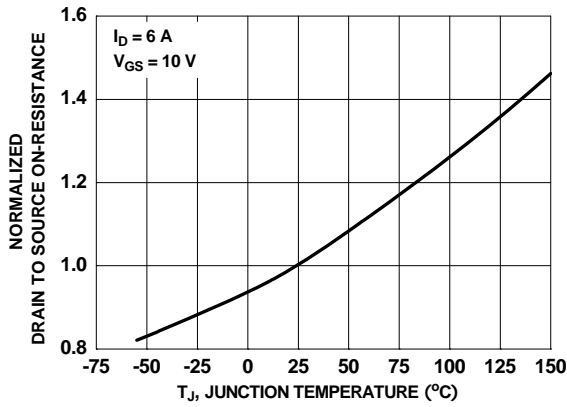

Figure 3. Normalized On Resistance vs Junction Temperature

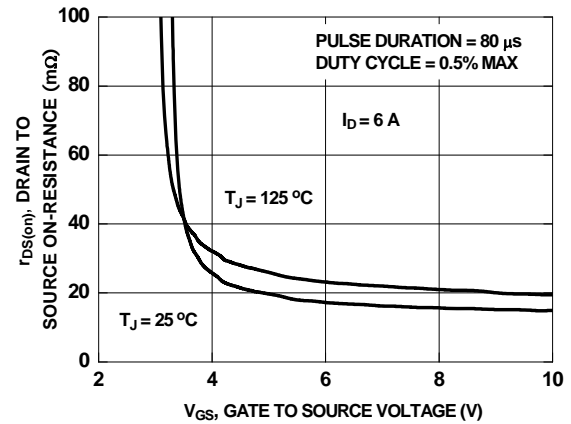

Figure 4. On-Resistance vs Gate to Source Voltage

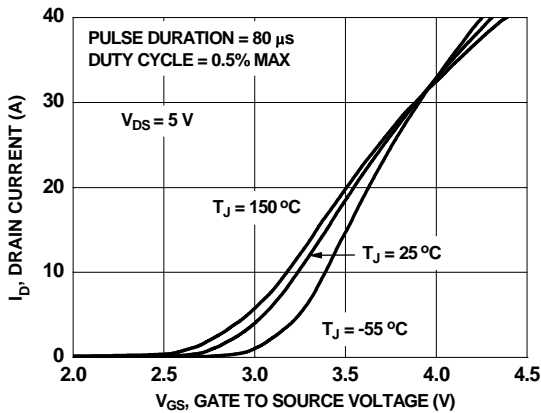

Figure 5. Transfer Characteristics

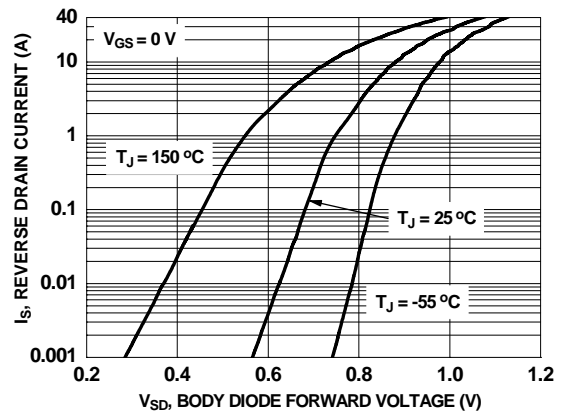

Figure 6. Source to Drain Diode Forward Voltage vs Source Current

Typical Characteristics (Q1 N-Channel) $T_J = 25^\circ\text{C}$ unless otherwise noted

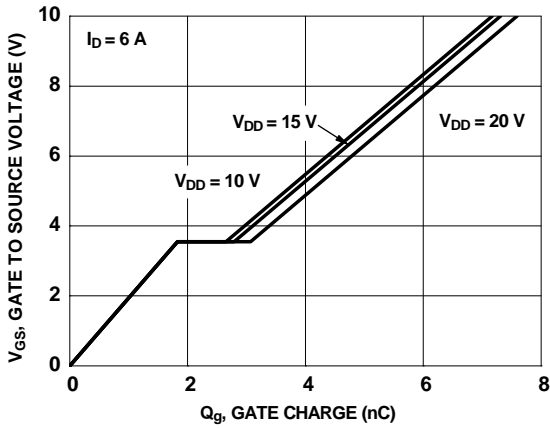

Figure 7. Gate Charge Characteristics

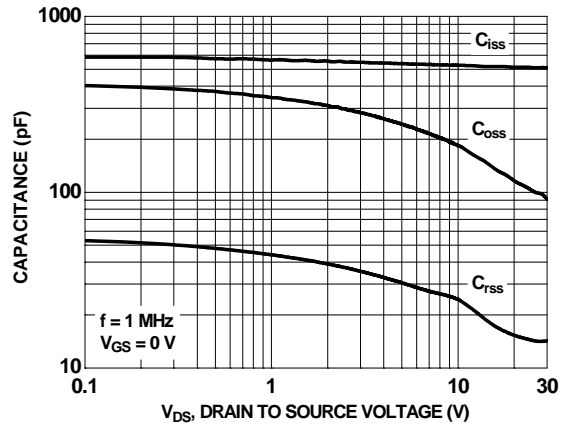

Figure 8. Capacitance vs Drain to Source Voltage

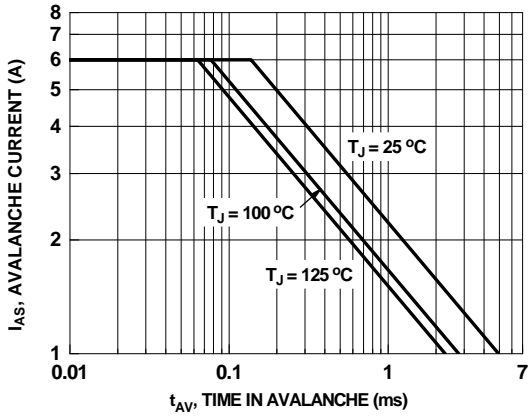

Figure 9. Unclamped Inductive Switching Capability

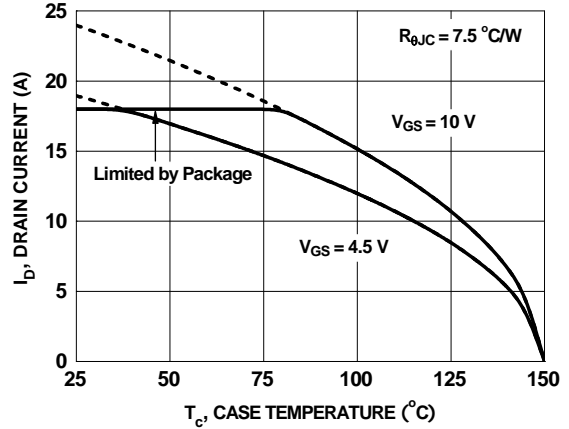

Figure 10. Maximum Continuous Drain Current vs Case Temperature

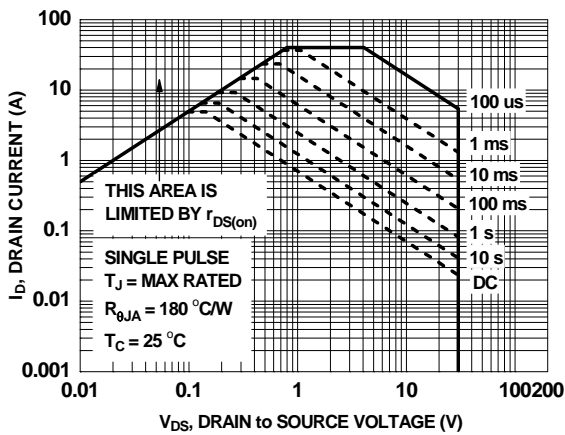

Figure 11. Forward Bias Safe Operating Area

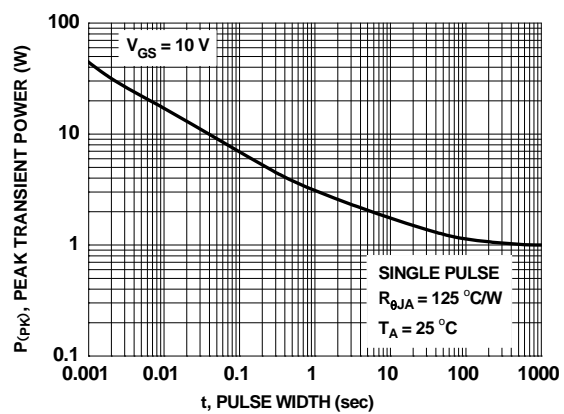

Figure 12. Single Pulse Maximum Power Dissipation

Typical Characteristics (Q1 N-Channel) $T_J = 25^\circ\text{C}$ unless otherwise noted

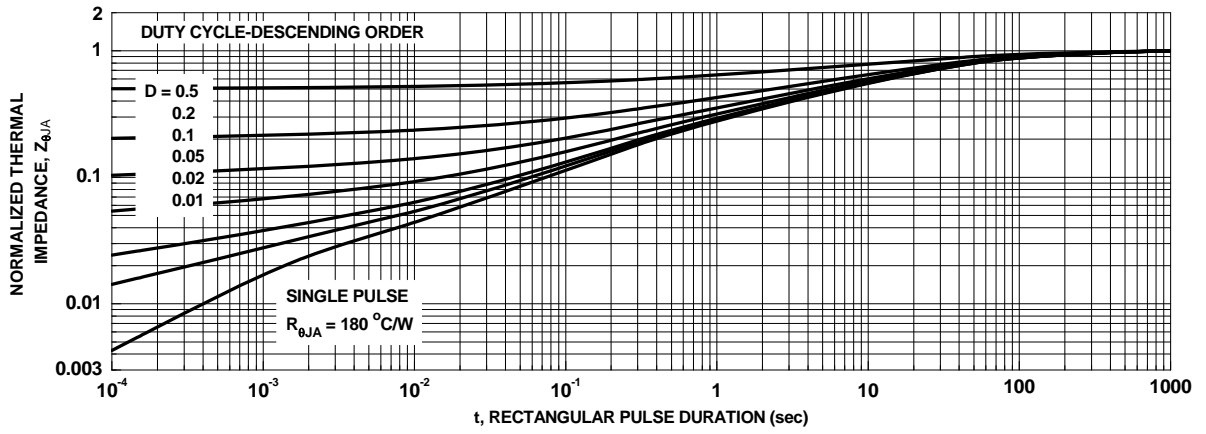

Figure 13. Junction-to-Ambient Transient Thermal Response Curve

Typical Characteristics (Q2 N-Channel) $T_J = 25\text{ }^\circ\text{C}$ unless otherwise noted

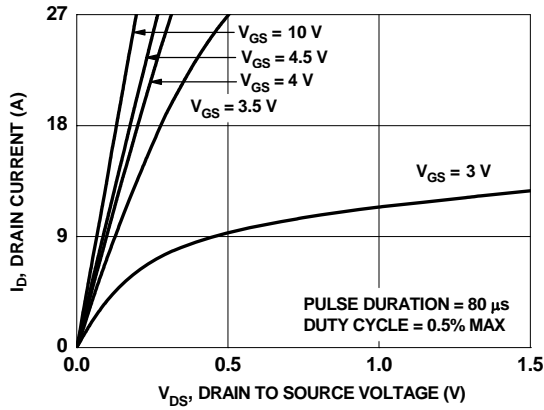

Figure 14. On-Region Characteristics

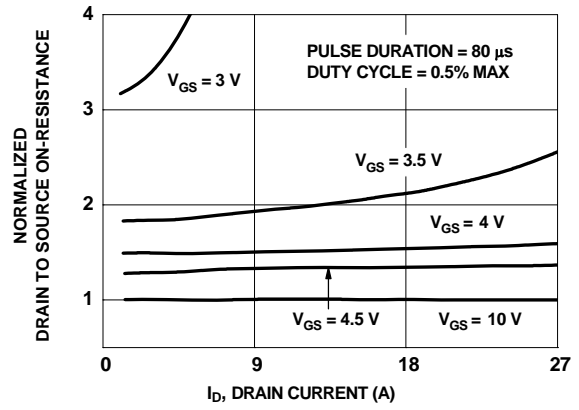

Figure 15. Normalized on-Resistance vs Drain Current and Gate Voltage

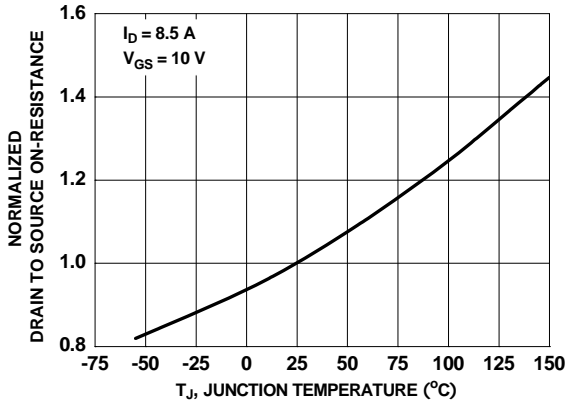

Figure 16. Normalized On-Resistance vs Junction Temperature

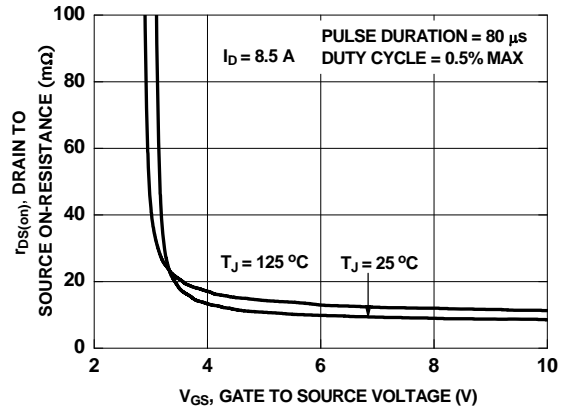

Figure 17. On-Resistance vs Gate to Source Voltage

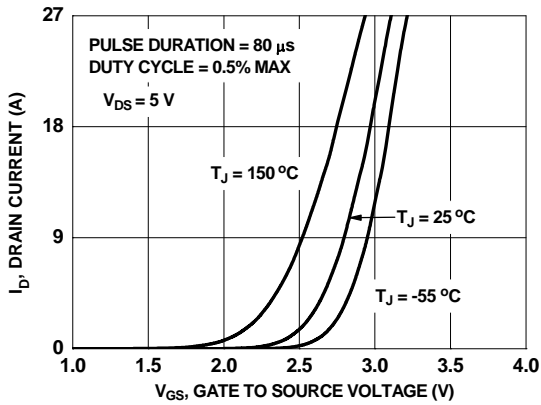

Figure 18. Transfer Characteristics

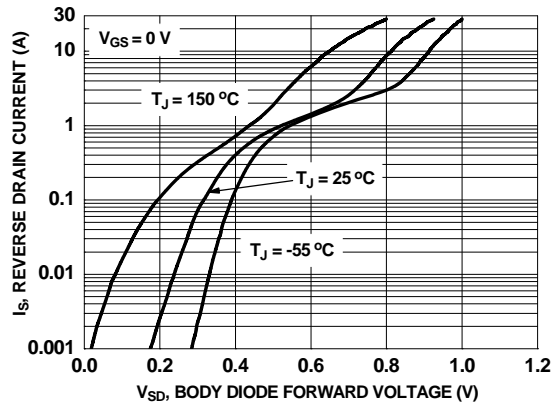

Figure 19. Source to Drain Diode Forward Voltage vs Source Current

Typical Characteristics (Q2 N-Channel) $T_J = 25^\circ\text{C}$ unless otherwise noted

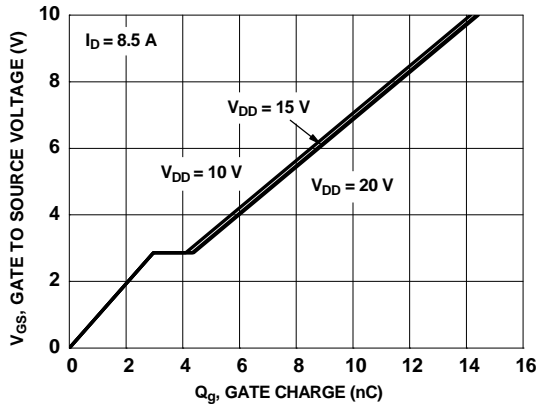

Figure 20. Gate Charge Characteristics

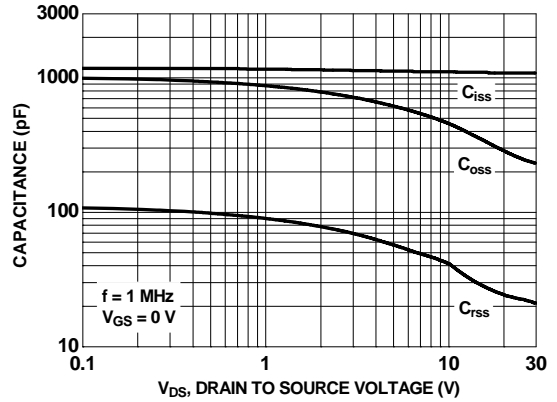

Figure 21. Capacitance vs Drain to Source Voltage

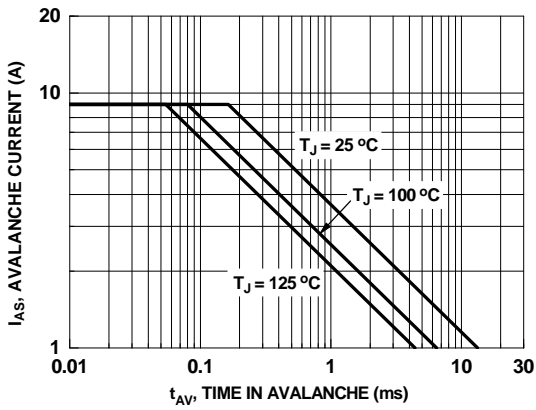

Figure 22. Unclamped Inductive Switching Capability

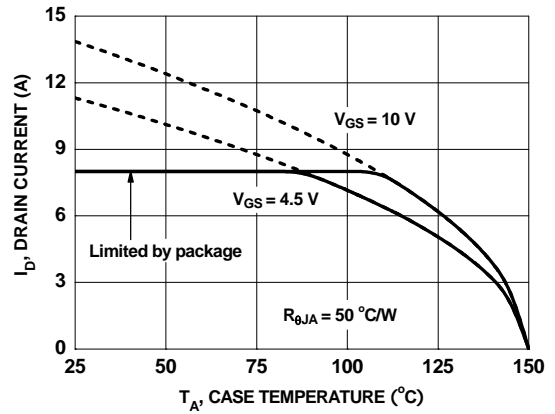

Figure 23. Maximum Continuous Drain Current vs Case Temperature

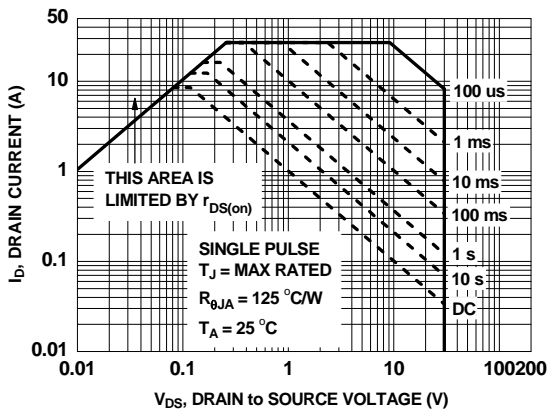

Figure 24. Forward Bias Safe Operating Area

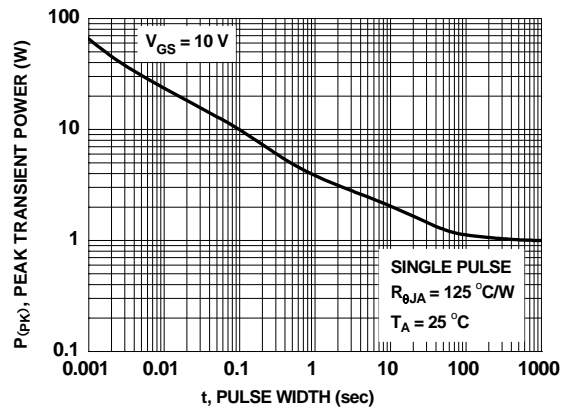

Figure 25. Single Pulse Maximum Power Dissipation

Typical Characteristics (Q2 N-Channel) $T_J = 25\text{ }^\circ\text{C}$ unless otherwise noted

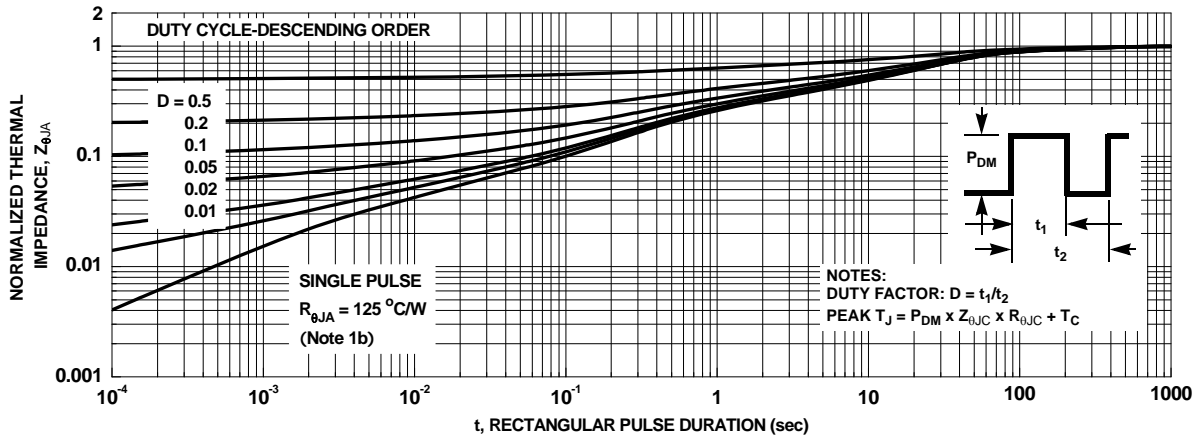

Figure 26. Junction-to-Ambient Transient Thermal Response Curve

Typical Characteristics (continued)

SyncFET Schottky body diode Characteristics

Fairchild's SyncFET process embeds a Schottky diode in parallel with PowerTrench MOSFET. This diode exhibits similar characteristics to a discrete external Schottky diode in parallel with a MOSFET. Figure 14 shows the reverse recovery characteristic of the FDMC8200S.

Schottky barrier diodes exhibit significant leakage at high temperature and high reverse voltage. This will increase the power in the device.

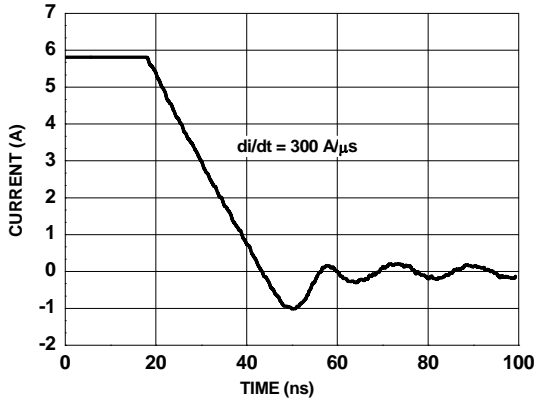

Figure 27. FDMC8200S SyncFET body diode reverse recovery characteristic

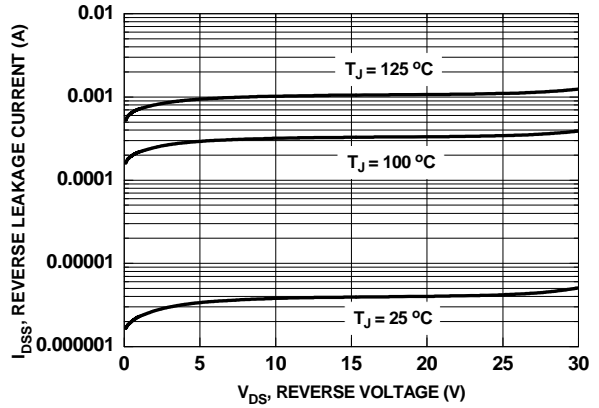
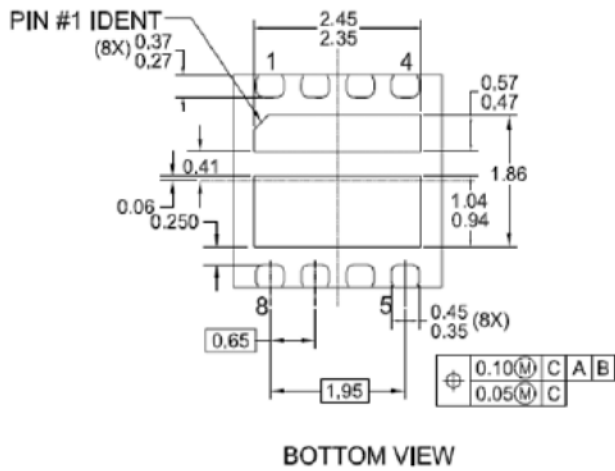
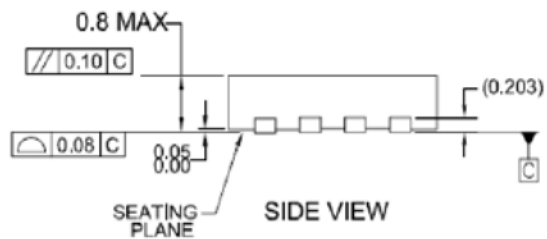
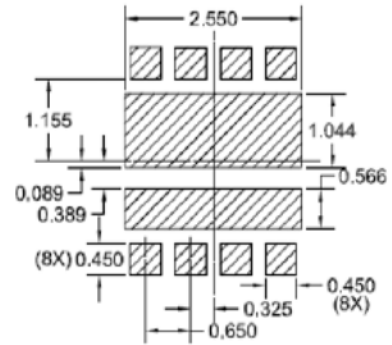
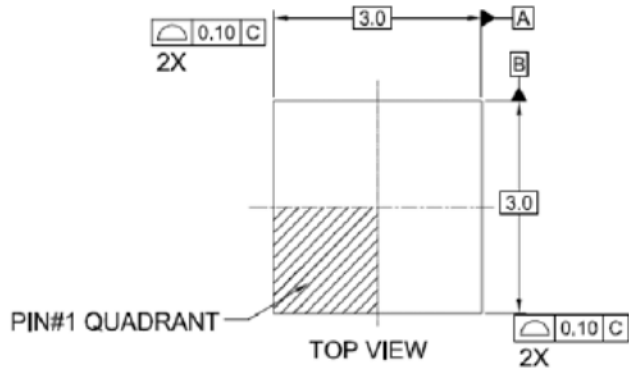

Figure 28. SyncFET body diode reverse leakage versus drain-source voltage

Dimensional Outline and Pad Layout





TRADEMARKS

The following includes registered and unregistered trademarks and service marks, owned by Fairchild Semiconductor and/or its global subsidiaries, and is not intended to be an exhaustive list of all such trademarks.

- | | | | |
|--------------------------|-------------------------------------|---------------------------------------|--|
| AccuPower™ | F-PFST™ | Power-SPM™ | The Power Franchise® |
| Auto-SPM™ | FRFET® | PowerTrench® | The Right Technology for Your Success™ |
| AX-CAP™* | Global Power Resource SM | PowerXS™ | |
| Build it Now™ | Green FPS™ | Programmable Active Droop™ | power |
| CorePLUS™ | Green FPS™ e-Series™ | QFET® | franchise |
| CorePOWER™ | Gmax™ | QS™ | TinyBoost™ |
| CROSSVOLT™ | GTO™ | Quiet Series™ | TinyBuck™ |
| CTL™ | IntelliMAX™ | RapidConfigure™ | TinyCalc™ |
| Current Transfer Logic™ | ISOPLANAR™ | | TinyLogic® |
| DEUXPEED® | MegaBuck™ | | TINYOPTO™ |
| Dual Cool™ | MICROCOUPLER™ | Saving our world, 1mW/W/kW at a time™ | TinyPower™ |
| EcoSPARK® | MicroFET™ | SignalWise™ | TinyPWM™ |
| EfficientMax™ | MicroPak™ | SmartMax™ | TinyWire™ |
| ESBC™ | MicroPak2™ | SMART START™ | TriFault Detect™ |
| F ® | MillerDrive™ | SPM® | TRUECURRENT®* |
| Fairchild® | MotionMax™ | STEALTH™ | µSerDes™ |
| Fairchild Semiconductor® | Motion-SPM™ | SuperFET® | µ |
| FACT Quiet Series™ | mWSaver™ | SuperSOT™-3 | SerDes™ |
| FACT® | OptiHIT™ | SuperSOT™-6 | UHC® |
| FAST® | OPTOLOGIC® | SuperSOT™-8 | Ultra FRFET™ |
| FastvCore™ | OPTOPLANAR® | SupreMOS® | UniFET™ |
| FETBench™ | | SyncFET™ | VCX™ |
| FlashWriter®* | | Sync-Lock™ | VisualMax™ |
| FPS™ | PDP SPM™ | | XST™ |
| | | SYSTEM | |
| | | GENERAL | |

*Trademarks of System General Corporation, used under license by Fairchild Semiconductor.

DISCLAIMER

FAIRCHILD SEMICONDUCTOR RESERVES THE RIGHT TO MAKE CHANGES WITHOUT FURTHER NOTICE TO ANY PRODUCTS HEREIN TO IMPROVE RELIABILITY, FUNCTION, OR DESIGN. FAIRCHILD DOES NOT ASSUME ANY LIABILITY ARISING OUT OF THE APPLICATION OR USE OF ANY PRODUCT OR CIRCUIT DESCRIBED HEREIN; NEITHER DOES IT CONVEY ANY LICENSE UNDER ITS PATENT RIGHTS, NOR THE RIGHTS OF OTHERS. THESE SPECIFICATIONS DO NOT EXPAND THE TERMS OF FAIRCHILD'S WORLDWIDE TERMS AND CONDITIONS, SPECIFICALLY THE WARRANTY THEREIN, WHICH COVERS THESE PRODUCTS.

LIFE SUPPORT POLICY

FAIRCHILD'S PRODUCTS ARE NOT AUTHORIZED FOR USE AS CRITICAL COMPONENTS IN LIFE SUPPORT DEVICES OR SYSTEMS WITHOUT THE EXPRESS WRITTEN APPROVAL OF FAIRCHILD SEMICONDUCTOR CORPORATION.

As used here in:

- Life support devices or systems are devices or systems which, (a) are intended for surgical implant into the body or (b) support or sustain life, and (c) whose failure to perform when properly used in accordance with instructions for use provided in the labeling, can be reasonably expected to result in a significant injury of the user.
- A critical component in any component of a life support, device, or system whose failure to perform can be reasonably expected to cause the failure of the life support device or system, or to affect its safety or effectiveness.

ANTI-COUNTERFEITING POLICY

Fairchild Semiconductor Corporation's Anti-Counterfeiting Policy. Fairchild's Anti-Counterfeiting Policy is also stated on our external website, www.Fairchildsemi.com, under Sales Support. Counterfeiting of semiconductor parts is a growing problem in the industry. All manufactures of semiconductor products are experiencing counterfeiting of their parts. Customers who inadvertently purchase counterfeit parts experience many problems such as loss of brand reputation, substandard performance, failed application, and increased cost of production and manufacturing delays. Fairchild is taking strong measures to protect ourselves and our customers from the proliferation of counterfeit parts. Fairchild strongly encourages customers to purchase Fairchild parts either directly from Fairchild or from Authorized Fairchild Distributors who are listed by country on our web page cited above. Products customers buy either from Fairchild directly or from Authorized Fairchild Distributors are genuine parts, have full traceability, meet Fairchild's quality standards for handling and storage and provide access to Fairchild's full range of up-to-date technical and product information. Fairchild and our Authorized Distributors will stand behind all warranties and will appropriately address and warranty issues that may arise. Fairchild will not provide any warranty coverage or other assistance for parts bought from Unauthorized Sources. Fairchild is committed to combat this global problem and encourage our customers to do their part in stopping this practice by buying direct or from authorized distributors.

PRODUCT STATUS DEFINITIONS

Definition of Terms

Datasheet Identification	Product Status	Definition
Advance Information	Formative / In Design	Datasheet contains the design specifications for product development. Specifications may change in any manner without notice.
Preliminary	First Production	Datasheet contains preliminary data; supplementary data will be published at a later date. Fairchild Semiconductor reserves the right to make changes at any time without notice to improve design.
No Identification Needed	Full Production	Datasheet contains final specifications. Fairchild Semiconductor reserves the right to make changes at any time without notice to improve the design.
Obsolete	Not In Production	Datasheet contains specifications on a product that is discontinued by Fairchild Semiconductor. The datasheet is for reference information only.

AMEYA360

Components Supply Platform

Authorized Distribution Brand :



Website :

Welcome to visit www.ameya360.com

Contact Us :

➤ Address :

401 Building No.5, JiuGe Business Center, Lane 2301, Yishan Rd
Minhang District, Shanghai , China

➤ Sales :

Direct +86 (21) 6401-6692

Email amall@ameya360.com

QQ 800077892

Skype [ameyasales1](#) [ameyasales2](#)

➤ Customer Service :

Email service@ameya360.com

➤ Partnership :

Tel +86 (21) 64016692-8333

Email mkt@ameya360.com