

Coiltronics FPT705 Family

Dual conductor, high current power inductors

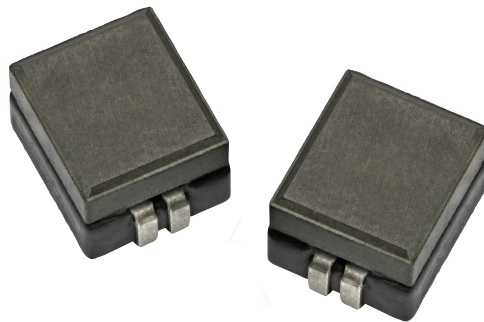

Description

- Dual conductor, two-turn construction
- Magnetically shielded
- 8.3 x 7.5mm footprint surface mount package in a 5.35mm height
- Ferrite core material
- Halogen free, lead free, RoHS compliant

Applications

- Compatible with Picor® Cool-Power® ZVS Buck and Buck-Boost Regulator Families (Picor part number series PI33xx and PI34xx)

Environmental Data

- Storage temperature range (component): -40°C to +125°C
- Operating temperature range: -40°C to +125°C (ambient plus self-temperature rise)
- Solder reflow temperature: J-STD-020D compliant



Picor® and Cool-Power® are trademarks of Vicor Corporation.



Powering Business Worldwide



The Coiltronics brand of magnetics (formerly of the Bussmann Division of Cooper Industries) is now part of Eaton's Electrical Group, Electronics Division.

Coiltronics is now part of Eaton
Same great products plus even more.

Product Specifications

Part Number ⁵	OCL ¹ (nH) ±10%	I _{rms} ² (amps)	I _{sat} ³ (amps)	DCR (mΩ) @ 20°C ±0.15 mΩ
FPT705-170-R	170 (±12%)	13	31	0.65
FPT705-190-R	190	13	28	0.65
FPT705-200-R	200	13	25	0.65
FPT705-230-R	230	13	23	0.65
FPT705-270-R	270	13	19	0.65
FPT705-300-R	300	13	17	0.65

1. Open Circuit Inductance (OCL) Test Parameters: 1.0MHz, 0.1Vrms, 0.0A_{dc}, 25°C

2. I_{rms}: DC current for an approximate temperature rise of 40°C without core loss. Derating is necessary for AC currents. PCB layout, trace thickness and width, air-flow, and proximity of other heat generating components will affect the temperature rise. It is recommended that the temperature of the part not exceed 125°C under worst case operating conditions verified in the end application.

3. I_{sat}: Peak current for approximately 2% rolloff @ +25°C

4. DCR tested from pins (1-2) and pins (4-3)

5. Part Number Definition: FPT705-xxx-R

FPT705 = Product code and size
xxx= Inductance value in nH,
-R suffix = RoHS compliant

Dimensions (mm)

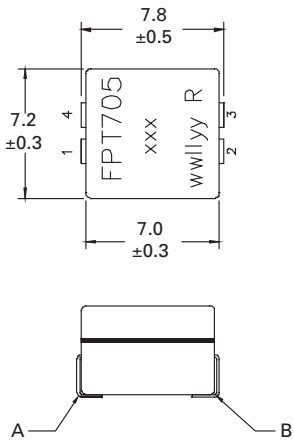

Recommended Pad Layout

Schematic

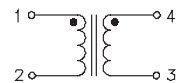
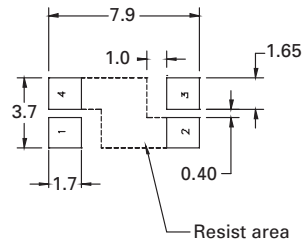
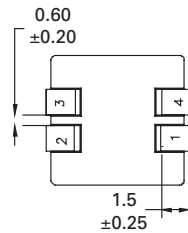

Part marking: FPT705, xxx=inductance value in nH, wwllly= date code R= revision level
Soldering surfaces to be coplanar within 0.10 millimeters
DCR is measured from point "a" to point "b"
Pins 2 and 4 are connected through the PCB trace

Packaging information (mm)

Supplied in tape and reel packaging, 1,000 parts per 13" diameter reel

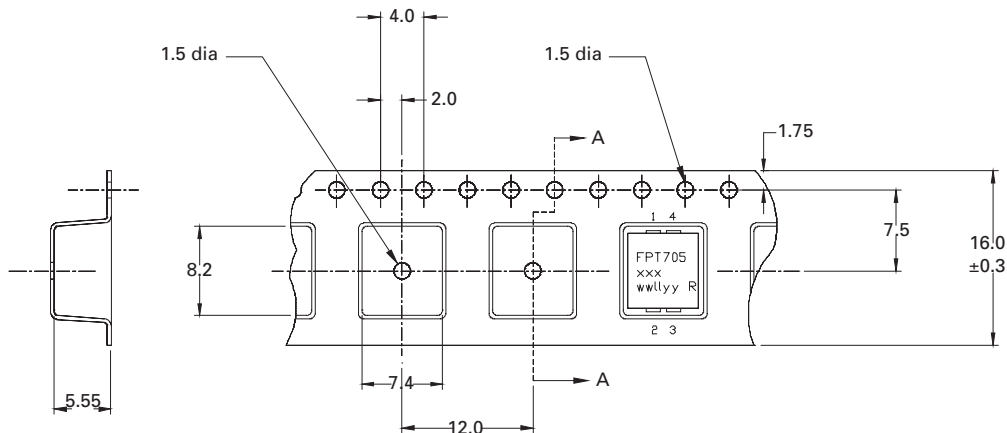

Section A-A

Direction of Feed →

Inductance characteristics

FPT705-170-R

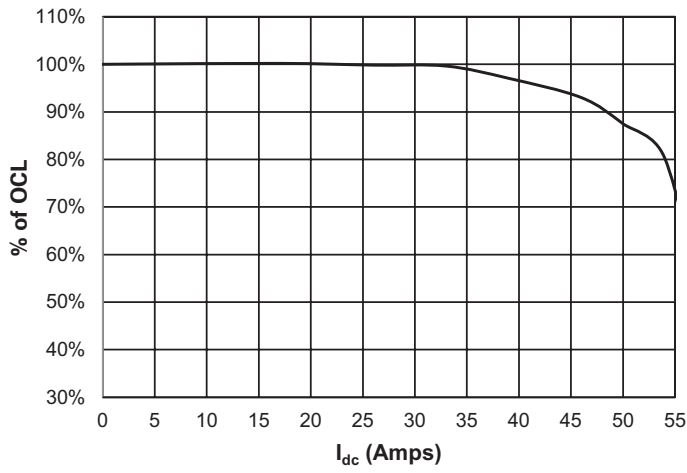

FPT705-190-R

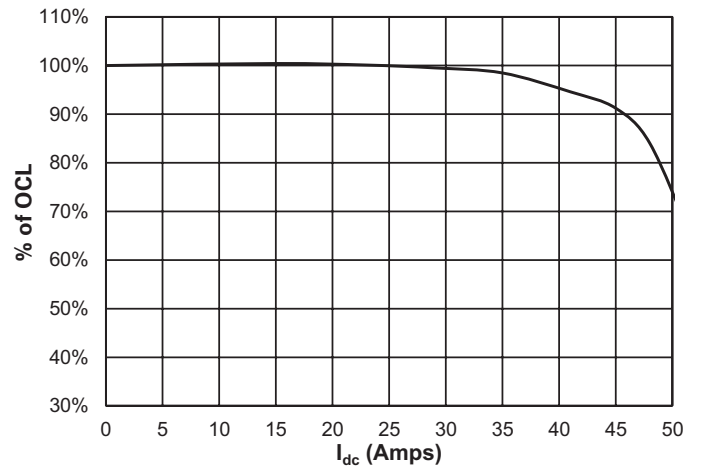

FPT705-200-R, FPT705-230-R

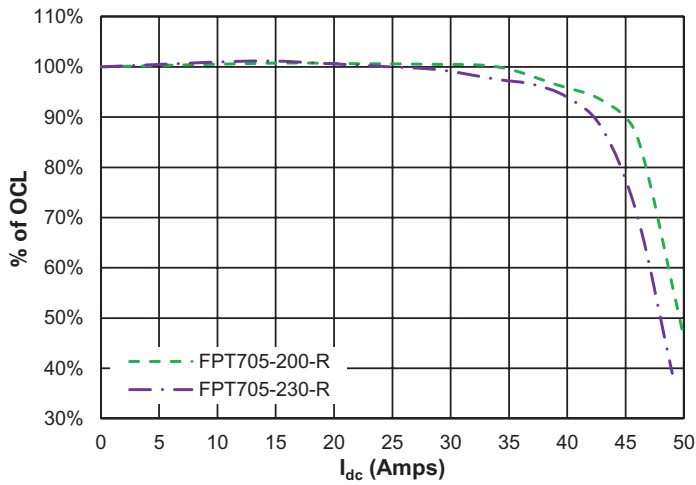

FPT705-270-R, FPT705-300-R

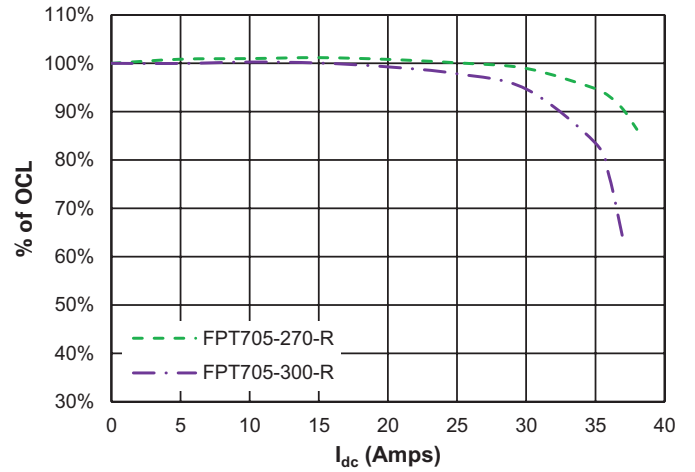

Solder reflow profile

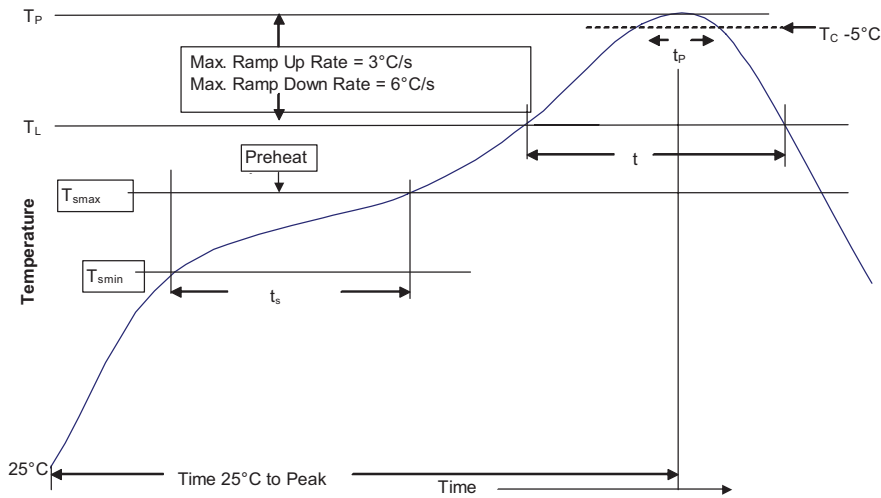

Table 1 - Standard SnPb Solder (T_c)

Package Thickness	Volume mm^3 <350	Volume mm^3 \geq 350
<2.5mm)	235°C	220°C
\geq 2.5mm	220°C	220°C

Table 2 - Lead (Pb) Free Solder (T_c)

Package Thickness	Volume mm^3 <350	Volume mm^3 350 - 2000	Volume mm^3 >2000
<1.6mm	260°C	260°C	260°C
1.6 - 2.5mm	260°C	250°C	245°C
>2.5mm	250°C	245°C	245°C

Reference JDEC J-STD-020D

Profile Feature	Standard SnPb Solder	Lead (Pb) Free Solder
Preheat and Soak		
• Temperature min. (T_{smin})	100°C	150°C
• Temperature max. (T_{smax})	150°C	200°C
• Time (T_{smin} to T_{smax}) (t_s)	60-120 Seconds	60-120 Seconds
Average ramp up rate T_{smax} to T_p	3°C/ Second Max.	3°C/ Second Max.
Liquidous temperature (T_L)	183°C	217°C
Time at liquidous (t_L)	60-150 Seconds	60-150 Seconds
Peak package body temperature (T_p)*	Table 1	Table 2
Time (t_p)** within 5 °C of the specified classification temperature (T_c)	20 Seconds**	30 Seconds**
Average ramp-down rate (T_p to T_{smax})	6°C/ Second Max.	6°C/ Second Max.
Time 25°C to Peak Temperature	6 Minutes Max.	8 Minutes Max.

* Tolerance for peak profile temperature (T_p) is defined as a supplier minimum and a user maximum.

** Tolerance for time at peak profile temperature (t_p) is defined as a supplier minimum and a user maximum.

Life Support Policy: Eaton does not authorize the use of any of its products for use in life support devices or systems without the express written approval of an officer of the Company. Life support systems are devices which support or sustain life, and whose failure to perform, when properly used in accordance with instructions for use provided in the labeling, can be reasonably expected to result in significant injury to the user.

Eaton
Electronics Division
1000 Eaton Boulevard
Cleveland, OH 44122
United States
www.eaton.com/elx

© 2015 Eaton
All Rights Reserved
Printed in USA
Publication No. 4451- BU-SB15121
March 2015

Eaton is a registered trademark.

All other trademarks are property of their respective owners.

AMEYA360

Components Supply Platform

Authorized Distribution Brand :



Website :

Welcome to visit www.ameya360.com

Contact Us :

➤ Address :

401 Building No.5, JiuGe Business Center, Lane 2301, Yishan Rd
Minhang District, Shanghai , China

➤ Sales :

Direct +86 (21) 6401-6692

Email amall@ameya360.com

QQ 800077892

Skype [ameyasales1](#) [ameyasales2](#)

➤ Customer Service :

Email service@ameya360.com

➤ Partnership :

Tel +86 (21) 64016692-8333

Email mkt@ameya360.com