

2N7002KW

N-Channel Enhancement Mode Field Effect Transistor

Features

- Low On-Resistance
- Low Gate Threshold Voltage
- Low Input Capacitance
- Fast Switching Speed
- Low Input/Output Leakage
- Ultra-Small Surface Mount Package
- Pb Free/RoHS Compliant
- ESD HBM=1000V as per JESD22 A114 and ESD CDM=1500V as per JESD22 C101

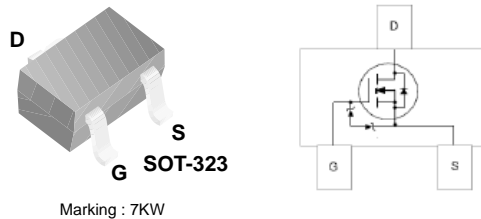

Absolute Maximum Ratings * $T_A = 25^\circ\text{C}$ unless otherwise noted

Symbol	Parameter	Value	Units
V_{DSS}	Drain-Source Voltage	60	V
V_{GSS}	Gate-Source Voltage	± 20	V
I_D	Maximum Drain Current	- Continuous	310
		$T_J = 100^\circ\text{C}$	195
		- Pulsed	1.2
T_J	Operating Junction Temperature Range	-55 to +150	$^\circ\text{C}$
T_{STG}	Storage Temperature Range	-55 to +150	$^\circ\text{C}$

* These ratings are limiting values above which the serviceability of any semiconductor device may be impaired.

Thermal Characteristics

Symbol	Parameter	Value	Units
P_D	Total Device Dissipation	300	mW
	Derating above $T_A = 25^\circ\text{C}$	2.4	mW/ $^\circ\text{C}$
$R_{\theta JA}$	Thermal Resistance, Junction to Ambient *	410	$^\circ\text{C}/\text{W}$

* Device mounted on FR-4 PCB, 1 inch x 0.85 inch x 0.062 inch. Minimum land pad size

Electrical Characteristics $T_A = 25^\circ\text{C}$ unless otherwise noted

Symbol	Parameter	Test Condition	Min.	Typ.	Max.	Units
Off Characteristics						
BV_{DSS}	Drain-Source Breakdown Voltage	$V_{GS} = 0V, I_D = 10\mu A$	60			V
I_{DSS}	Zero Gate Voltage Drain Current	$V_{DS} = 60V, V_{GS} = 0V$ $V_{DS} = 60V, V_{GS} = 0V, T_J = 125^\circ\text{C}$			1.0 0.5	μA mA
I_{GSS}	Gate-Body Leakage	$V_{GS} = \pm 20V, V_{DS} = 0V$			± 10	μA
On Characteristics (Note1)						
$V_{GS(th)}$	Gate Threshold Voltage	$V_{DS} = V_{GS}, I_D = 250\mu A$	1.1		2.1	V
$R_{DS(on)}$	Static Drain-Source On-Resistance	$V_{GS} = 10V, I_D = 500mA$ $V_{GS} = 10V, I_D = 500mA, T_J = 100^\circ\text{C}$ $V_{GS} = 5V, I_D = 50mA$ $V_{GS} = 5V, I_D = 50mA, T_J = 100^\circ\text{C}$			1.6 2.4 2 3	Ω Ω Ω Ω
$V_{DS(on)}$	Drain-Source On-Voltage	$V_{GS} = 10V, I_D = 500mA$ $V_{GS} = 5V, I_D = 50mA$			3.75 1.5	V V
$I_{D(on)}$	On-State Drain Current	$V_{GS} = 10V, V_{DS} = 2V$	500			mA
g_{FS}	Forward Transconductance	$V_{DS} = 2V, I_D = 0.2A$	80			mS
Dynamic Characteristics						
C_{iss}	Input Capacitance	$V_{DS} = 25V, V_{GS} = 0V, f = 1.0MHz$			50	pF
C_{oss}	Output Capacitance				25	pF
C_{rss}	Reverse Transfer Capacitance				5	pF
Switching Characteristics						
$t_{D(on)}$	Turn-On Delay Time	$V_{DD} = 30V, R_L = 150\Omega, V_{GS} = 10V,$ $I_D = 200mA, R_{GEN} = 25\Omega$			20	ns
$t_{D(off)}$	Turn-Off Delay Time				60	ns
Drain-Source Diode Characteristics and Maximum Ratings						
I_S	Maximum Continuous Drain-Source Diode Forward Current				115	mA
I_{SM}	Maximum Pulsed Drain-Source Diode Forward Current				0.8	A
V_{SD}	Drain-Source Diode Forward Voltage	$V_{GS} = 0V, I_S = 115mA$			1.1	V

Note1 : 1. Pulse Test: Pulse Width < 300 μs , Duty Cycle < 2.0%.

Typical Performance Characteristics

Figure 1. On-Region Characteristics.

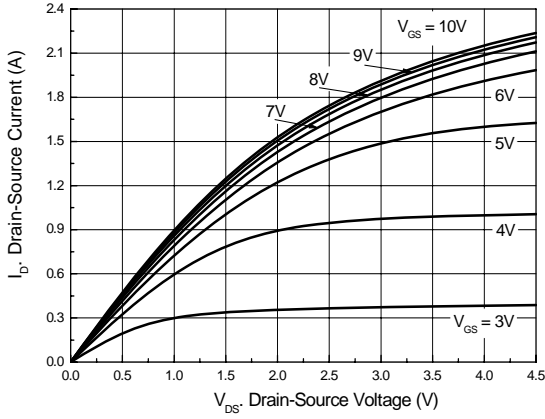

Figure 2. On-Resistance Variation with Temperature.

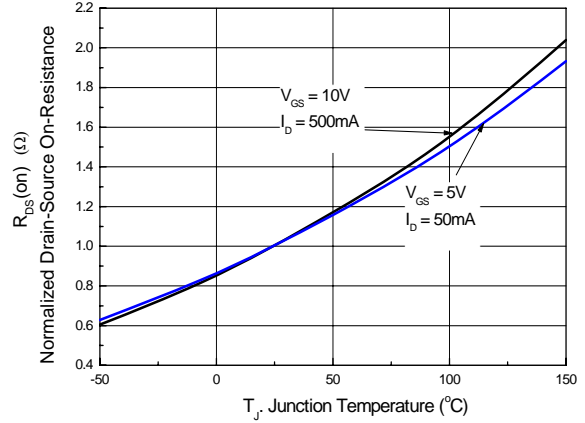

Figure 3. On-Resistance Variation with Gate Voltage and Drain Current.

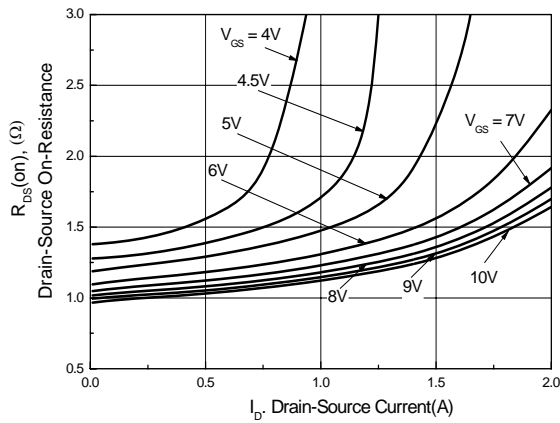

Figure 4. On-Resistance Variation with Drain Current and Temperature.

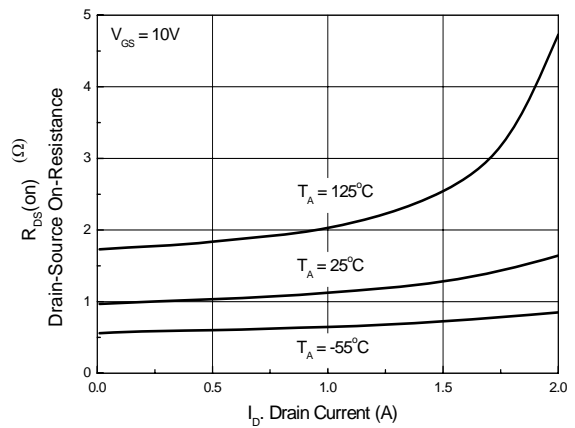

Figure 5. Transfer Characteristics

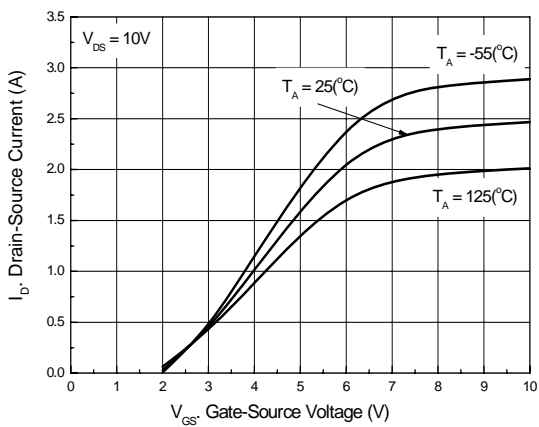
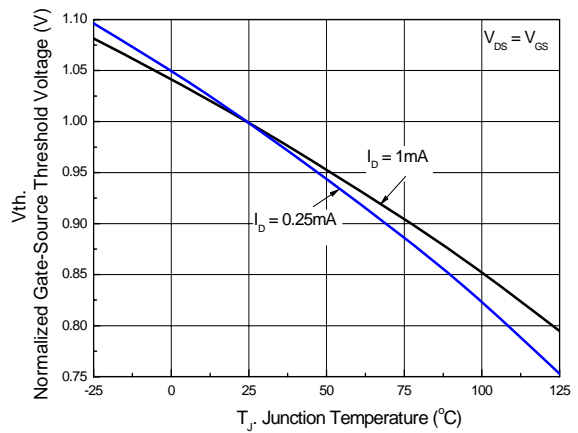

Figure 6. Gate Threshold Variation with Temperature.



Typical Performance Characteristics (Continued)

Figure 7. Breakdown Voltage Variation with Temperature

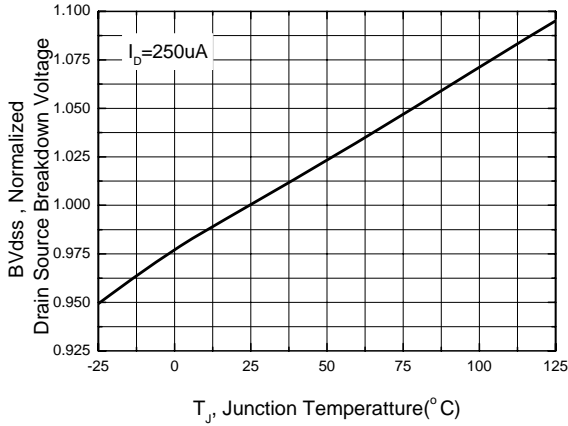

Figure 8. Body Diode Forward Voltage Variation with Source Current and Temperature.

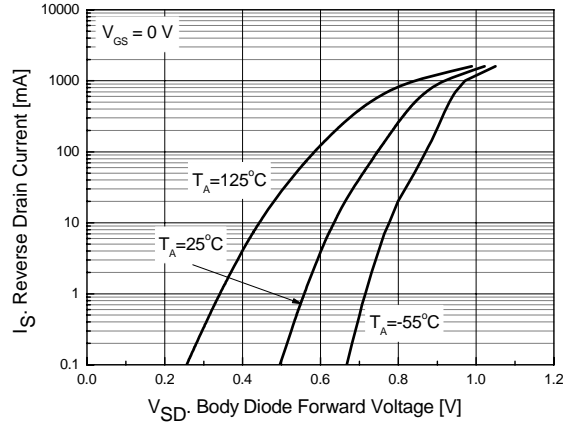

Figure 9. Capacitance Characteristics.

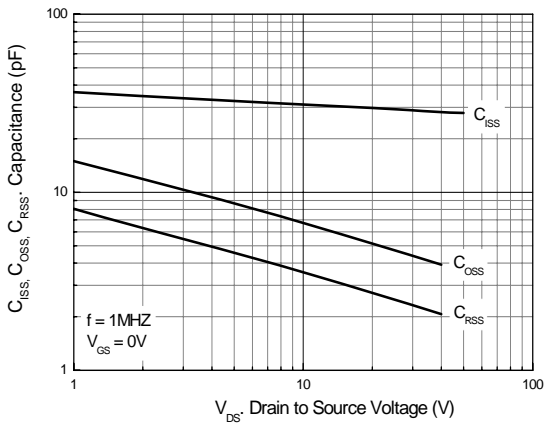

Figure 10. Gate Charge Characteristics.

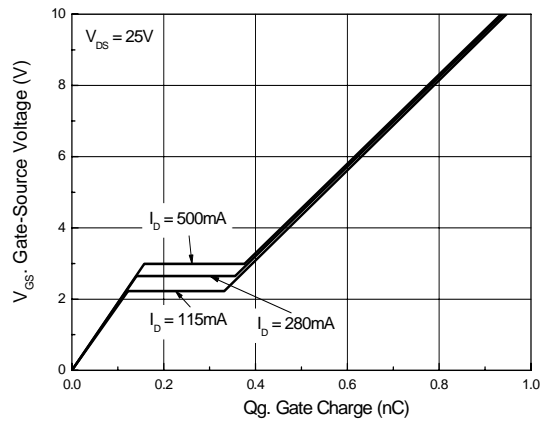

Figure 11. Maximum Safe Operating Area.

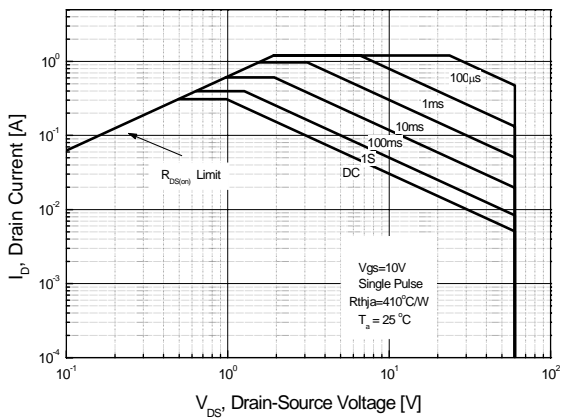
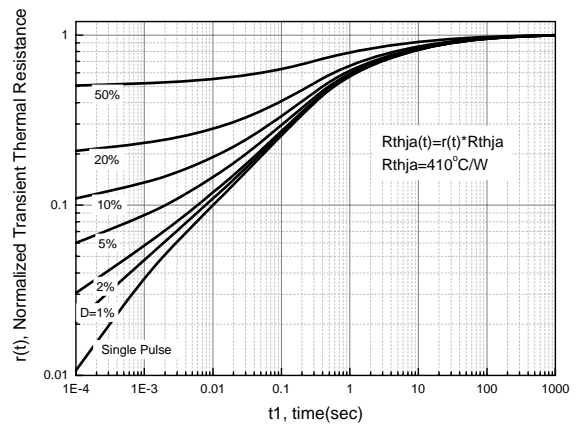
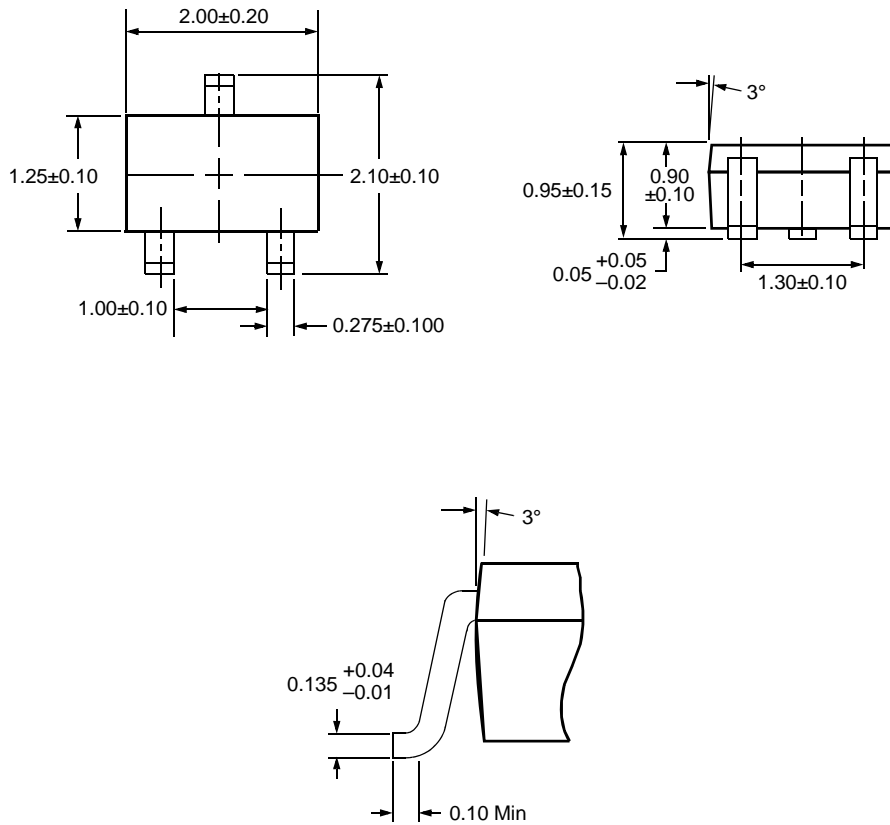

Figure 12. Transient Thermal Response Curve.



Physical Dimensions

SOT-323







Dimensions in Millimeters



TRADEMARKS

The following includes registered and unregistered trademarks and service marks, owned by Fairchild Semiconductor and/or its global subsidiaries, and is not intended to be an exhaustive list of all such trademarks.

- | | | | |
|--|---|--|---|
| AccuPower™ | F-PFS™ | Power-SPM™ | The Power Franchise® |
| Auto-SPM™ | FRFET® | PowerTrench® | The Right Technology for Your Success™ |
| AX-CAP™* | Global Power Resource SM | PowerXS™ | the power franchise |
| Build it Now™ | Green FPS™ | Programmable Active Droop™ | TinyBoost™ |
| CorePLUS™ | Green FPS™ e-Series™ | QFET® | TinyBuck™ |
| CorePOWER™ | Gmax™ | QS™ | TinyCalc™ |
| CROSSVOLT™ | GTO™ | Quiet Series™ | TinyLogic® |
| CTL™ | IntelliMAX™ | RapidConfigure™ | TINYOPTO™ |
| Current Transfer Logic™ | ISOPLANAR™ |  ™ | TinyPower™ |
| DEUXPEED® | MegaBuck™ | Saving our world, 1mW/W/kW at a time™ | TinyPWM™ |
| Dual Cool™ | MICROCOUPLER™ | SignalWise™ | TinyWire™ |
| EcoSPARK® | MicroFET™ | SmartMax™ | TriFault Detect™ |
| EfficientMax™ | MicroPak™ | SMART START™ | TRUECURRENT®* |
| ESBC™ | MicroPak2™ | SPM® | μSerDes™ |
|  Fairchild® | MillerDrive™ | STEALTH™ |  SerDes™ |
| Fairchild Semiconductor® | MotionMax™ | SuperFET® | UHC® |
| FACT Quiet Series™ | Motion-SPM™ | SuperSOT™-3 | Ultra FRFET™ |
| FACT® | mWSaver™ | SuperSOT™-6 | UniFET™ |
| FAST® | OptoHiT™ | SuperSOT™-8 | VCX™ |
| FastvCore™ | OPTOLOGIC® | SupreMOS® | VisualMax™ |
| FETBench™ | OPTOPLANAR® | SyncFET™ | XS™ |
| FlashWriter®* |  ™ | Sync-Lock™ | |
| FPS™ | PDP SPM™ |  SYSTEM GENERAL®* | |

* Trademarks of System General Corporation, used under license by Fairchild Semiconductor.

DISCLAIMER

FAIRCHILD SEMICONDUCTOR RESERVES THE RIGHT TO MAKE CHANGES WITHOUT FURTHER NOTICE TO ANY PRODUCTS HEREIN TO IMPROVE RELIABILITY, FUNCTION, OR DESIGN. FAIRCHILD DOES NOT ASSUME ANY LIABILITY ARISING OUT OF THE APPLICATION OR USE OF ANY PRODUCT OR CIRCUIT DESCRIBED HEREIN; NEITHER DOES IT CONVEY ANY LICENSE UNDER ITS PATENT RIGHTS, NOR THE RIGHTS OF OTHERS. THESE SPECIFICATIONS DO NOT EXPAND THE TERMS OF FAIRCHILD'S WORLDWIDE TERMS AND CONDITIONS, SPECIFICALLY THE WARRANTY THEREIN, WHICH COVERS THESE PRODUCTS.

LIFE SUPPORT POLICY

FAIRCHILD'S PRODUCTS ARE NOT AUTHORIZED FOR USE AS CRITICAL COMPONENTS IN LIFE SUPPORT DEVICES OR SYSTEMS WITHOUT THE EXPRESS WRITTEN APPROVAL OF FAIRCHILD SEMICONDUCTOR CORPORATION.

As used herein:

1. Life support devices or systems are devices or systems which, (a) are intended for surgical implant into the body or (b) support or sustain life, and (c) whose failure to perform when properly used in accordance with instructions for use provided in the labeling, can be reasonably expected to result in a significant injury of the user.
2. A critical component in any component of a life support, device, or system whose failure to perform can be reasonably expected to cause the failure of the life support device or system, or to affect its safety or effectiveness.

ANTI-COUNTERFEITING POLICY

Fairchild Semiconductor Corporation's Anti-Counterfeiting Policy. Fairchild's Anti-Counterfeiting Policy is also stated on our external website, www.fairchildsemi.com, under Sales Support.

Counterfeiting of semiconductor parts is a growing problem in the industry. All manufacturers of semiconductor products are experiencing counterfeiting of their parts. Customers who inadvertently purchase counterfeit parts experience many problems such as loss of brand reputation, substandard performance, failed applications, and increased cost of production and manufacturing delays. Fairchild is taking strong measures to protect ourselves and our customers from the proliferation of counterfeit parts. Fairchild strongly encourages customers to purchase Fairchild parts either directly from Fairchild or from Authorized Fairchild Distributors who are listed by country on our web page cited above. Products customers buy either from Fairchild directly or from Authorized Fairchild Distributors are genuine parts, have full traceability, meet Fairchild's quality standards for handling and storage and provide access to Fairchild's full range of up-to-date technical and product information. Fairchild and our Authorized Distributors will stand behind all warranties and will appropriately address any warranty issues that may arise. Fairchild will not provide any warranty coverage or other assistance for parts bought from Unauthorized Sources. Fairchild is committed to combat this global problem and encourage our customers to do their part in stopping this practice by buying direct or from authorized distributors.

PRODUCT STATUS DEFINITIONS

Definition of Terms

Datasheet Identification	Product Status	Definition
Advance Information	Formative / In Design	Datasheet contains the design specifications for product development. Specifications may change in any manner without notice.
Preliminary	First Production	Datasheet contains preliminary data; supplementary data will be published at a later date. Fairchild Semiconductor reserves the right to make changes at any time without notice to improve design.
No Identification Needed	Full Production	Datasheet contains final specifications. Fairchild Semiconductor reserves the right to make changes at any time without notice to improve the design.
Obsolete	Not In Production	Datasheet contains specifications on a product that is discontinued by Fairchild Semiconductor. The datasheet is for reference information only.

AMEYA360

Components Supply Platform

Authorized Distribution Brand :



Website :

Welcome to visit www.ameya360.com

Contact Us :

➤ Address :

401 Building No.5, JiuGe Business Center, Lane 2301, Yishan Rd
Minhang District, Shanghai , China

➤ Sales :

Direct +86 (21) 6401-6692

Email amall@ameya360.com

QQ 800077892

Skype [ameyasales1](#) [ameyasales2](#)

➤ Customer Service :

Email service@ameya360.com

➤ Partnership :

Tel +86 (21) 64016692-8333

Email mkt@ameya360.com