

FEATURES

- 5 V stereo audio DAC system
- Accepts 16-bit/18-bit/20-bit/24-bit data
- Supports 24 bits, 192 kHz sample rate
- Accepts a wide range of sample rates including 32 kHz, 44.1 kHz, 48 kHz, 88.2 kHz, 96 kHz, and 192 kHz
- Multibit Σ - Δ modulator with perfect differential linearity restoration for reduced idle tones and noise floor
- Data-directed scrambling DAC—least sensitive to jitter
- Differential output for optimum performance
- 117 dB signal-to-noise (not muted) at 48 kHz sample rate (A-weighted mono)
- 114 dB signal-to-noise (not muted) at 48 kHz sample rate (A-weighted stereo)
- 117 dB dynamic range (not muted) at 48 kHz sample rate (A-weighted mono)
- 114 dB dynamic range (not muted) at 48 kHz sample rate (A-weighted stereo)
- 105 dB THD+N (mono application circuit)
- 102 dB THD+N (stereo)
- 115 dB stop-band attenuation
- On-chip clickless volume control
- Hardware and software controllable clickless mute
- Serial (SPI) control for: serial mode, number of bits, sample rate, volume, mute, de-emp
- Digital de-emphasis processing for 32 kHz, 44.1 kHz, 48 kHz sample rates
- Clock autotdivide circuit supports five master-clock frequencies
- Flexible serial data port with right-justified, left-justified, I²S-compatible and DSP serial port modes
- 28-Lead SSOP plastic package

APPLICATIONS

High end
DVDs, CDs, home theater systems, automotive, audio systems, sampling musical keyboards, digital mixing consoles, and digital audio effects processors

GENERAL DESCRIPTION

The AD1852 is a complete, high performance, single-chip, stereo digital, audio playback system. It is comprised of a multibit, Σ - Δ modulator, digital interpolation filters, and analog output drive circuitry. Other features include an on-chip, stereo attenuator and mute, programmed through an SPI-compatible serial control port. The AD1852 is fully compatible with all known DVD formats, including 192 kHz, as well as 96 kHz sample frequencies and 24 bits. It is also backwards compatible by supporting 50 μ s/15 μ s digital de-emphasis intended for Red Book compact discs, as well as de-emphasis at 32 kHz and 48 kHz sample rate.

The AD1852 has a very simple, but very flexible, serial data input port that allows for glueless interconnection to a variety of ADCs, DSP chips, AES/EBU receivers, and sample rate converters. The AD1852 can be configured in left-justified, I²S, right-justified, or DSP serial port compatible modes. It can support 16, 18, 20, and 24 bits in all modes. The AD1852 accepts serial audio data in MSB first, twos-complement format. The AD1852 operates from a single 5 V power supply. It is fabricated on a single, monolithic integrated circuit and is housed in a 28-lead SSOP for operation over the 0°C to 70°C temperature range.

FUNCTIONAL BLOCK DIAGRAM

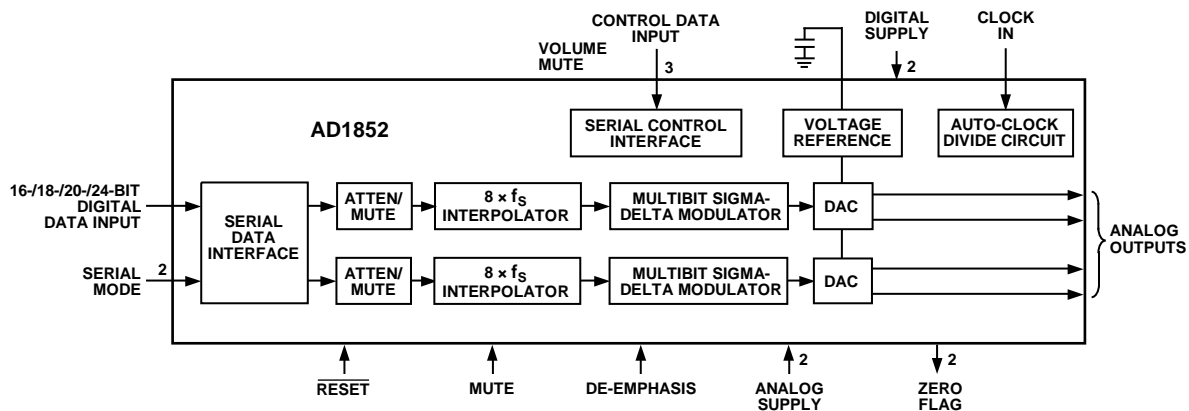

Figure 1.

Rev. A

Information furnished by Analog Devices is believed to be accurate and reliable. However, no responsibility is assumed by Analog Devices for its use, nor for any infringements of patents or other rights of third parties that may result from its use. Specifications subject to change without notice. No license is granted by implication or otherwise under any patent or patent rights of Analog Devices. Trademarks and registered trademarks are the property of their respective owners.

TABLE OF CONTENTS

Features	1	Typical Performance Characteristics	9
Applications.....	1	Theory of Operation	12
General Description	1	Serial Data Input Port.....	12
Functional Block Diagram	1	Serial Data Input Mode	12
Revision History	2	Master Clock Autodivide Feature	13
Specifications.....	3	SPI Register Definitions	13
Analog Performance	3	Register Addresses.....	14
Digital I/O (0°C to 70°C).....	4	Volume Left and Volume Right Registers	14
Temperature Range	4	SPI Timing.....	14
Power.....	4	Mute	14
Digital Filter Characteristics	4	Control Register	15
Group Delay	4	De-Emphasis.....	15
Digital Timing.....	5	Output Impedance	15
Absolute Maximum Ratings.....	6	Reset.....	15
Thermal Resistance	6	Control Signals	15
ESD Caution.....	6	Outline Dimensions	18
Pin Configuration and Function Descriptions.....	7	Ordering Guide	18

REVISION HISTORY

11/09—Rev. 0 to Rev. A

Changes to Format	Universal
Changes to Note 1.....	1
Changes to Table 2.....	3
Changes to Table 11.....	7
Changes to Register Addresses Section and Mute Section	14
Changes to Figure 29.....	16

1/00—Revision 0: Initial Version

SPECIFICATIONS

Test conditions, unless otherwise noted.

Table 1.

Parameter	Rating
Supply Voltages (AVDD, DVDD)	5.0 V
Ambient Temperature	25°C
Input Clock	24.576 MHz (512 × f _s Mode)
Input Signal	996.11 Hz
	–0.5 dB full scale
Input Sample Rate	48 kHz
Measurement Bandwidth	20 Hz to 20 kHz
Word Width	20 bits
Load Capacitance	100 pF
Load Impedance	47 kΩ
Input Voltage High	2.4 V
Input Voltage Low	0.8 V

ANALOG PERFORMANCE

Table 2.

Parameter ¹	Min	Typ	Max	Unit
RESOLUTION		24		Bits
SIGNAL-TO-NOISE RATIO (20 Hz TO 20 kHz)				
No Filter (Stereo)		112		dB
No Filter (Mono, See Figure 19)		115		dB
With A-Weighted Filter (Stereo)		114		dB
With A-Weighted Filter (Mono)		117		dB
DYNAMIC RANGE (20 Hz To 20 kHz, –60 dB INPUT)				
No Filter (Stereo)	107	112		dB
No Filter (Mono, See Figure 24)		115		dB
With A-Weighted Filter (Stereo)	110	114		dB
With A-Weighted Filter (Mono)		117		dB
TOTAL HARMONIC DISTORTION + NOISE (STEREO)	–94	–102		dB
		0.00079		%
TOTAL HARMONIC DISTORTION + NOISE (MONO, SEE Figure 20)		–105		dB
		0.00056		%
TOTAL HARMONIC DISTORTION + NOISE (STEREO) V _o = –20 dB		–92		dB
TOTAL HARMONIC DISTORTION + NOISE (STEREO) V _o = –60 dB		–52		dB
ANALOG OUTPUTS				
Differential Output Range (±Full Scale)		5.6		V p-p
Output Capacitance at Each Output Pin			2	pF
OUT-OF-BAND ENERGY (0.5 × f _s TO 100 kHz)			–90	dB
CMOUT		2.37		V
DC ACCURACY				
Gain Error	–10	±2.0	+10	%
Interchannel Gain Mismatch	–0.15	±0.015	+0.15	dB
Gain Drift		150	250	ppm/°C
DC Offset		–50		mV
INTERCHANNEL CROSSTALK (EIAJ METHOD)		–120		dB
INTERCHANNEL PHASE DEVIATION		±0.1		Degrees
MUTE ATTENUATION		–100		dB
DE-EMPHASIS GAIN ERROR			±0.1	dB

¹ Performance of right and left channels is identical (exclusive of the Interchannel Gain Mismatch and Interchannel Phase Deviation specifications).

AD1852

DIGITAL I/O (0°C TO 70°C)

Table 3.

Parameter	Min	Typ	Max	Unit
Input Voltage High (V_{IH})	2.2			V
Input Voltage Low (V_{IL})			0.8	V
Input Leakage (I_{IH} at $V_{IH} = 2.4$ V)			10	μ A
Input Leakage (I_{IL} at $V_{IL} = 0.8$ V)			10	μ A
High Level Output Voltage (V_{OH}), $I_{OH} = 1$ mA	2.0			V
Low Level Output Voltage (V_{OL}), $I_{OL} = 1$ mA			0.4	V
Input Capacitance			20	pF

TEMPERATURE RANGE

Table 4.

Parameter	Min	Typ	Max	Unit
Specifications Guaranteed		25		°C
Functionality Guaranteed	0		70	°C
Storage	-55		+150	°C

POWER

Table 5.

Parameter	Min	Typ	Max	Unit
SUPPLIES				
Voltage, Analog and Digital	4.50	5	5.50	V
Analog Current		33	40	mA
Analog Current— $\overline{\text{RESET}}$		32	46	mA
Digital Current		20	30	mA
Digital Current— $\overline{\text{RESET}}$		27	37	mA
DISSIPATION				
Operation—Both Supplies		265		mW
Operation—Analog Supply		165		mW
Operation—Digital Supply		100		mW
POWER SUPPLY REJECTION RATIO				
1 kHz, 300 mV p-p Signal at Analog Supply Pins			-60	dB
20 kHz, 300 mV p-p Signal at Analog Supply Pins			-50	dB

DIGITAL FILTER CHARACTERISTICS

Table 6.

Sample Rate (kHz)	Pass Band (kHz)	Stop Band (kHz)	Stop-Band Attenuation (dB)	Pass-Band Ripple (dB)
44.1	DC – 20	24.1 – 328.7	110	± 0.0002
48	DC – 21.8	26.23 – 358.28	110	± 0.0002
96	DC – 39.95	56.9 – 327.65	115	± 0.0005
192	DC – 87.2	117 – 327.65	95	+0/-0.04 (DC – 21.8 kHz) +0/-0.5 (DC – 65.4 kHz) +0/-1.5 (DC – 87.2 kHz)

GROUP DELAY

Table 7.

Chip Mode	Group Delay Calculation	f_s (kHz)	Group Delay (μ s)
INT8x Mode	$5553/(128 \times f_s)$	48	903.8
INT4x Mode	$5601/(64 \times f_s)$	96	911.6
INT2x Mode	$5659/(32 \times f_s)$	192	921

DIGITAL TIMING

Guaranteed over 0°C to 70°C, AVDD = DVDD = 5.0 V × 10%.

Table 8.

Parameter	Description	Min	Unit
t _{DMP}	MCLK period ($f_{MCLK} = 256 \times f_{LRCLK}$) ¹	54	ns
t _{DML}	MCLK low pulse width (all modes)	$0.4 \times t_{DMP}$	ns
t _{DMH}	MCLK high pulse width (all modes)	$0.4 \times t_{DMP}$	ns
t _{DBH}	BCLK high pulse width (see Figure 26)	20	ns
t _{DBL}	BCLK low pulse width (see Figure 26)	20	ns
t _{DBP}	BCLK period (see Figure 26)	60	ns
t _{DLS}	LRCLK setup (see Figure 26)	20	ns
t _{DLH}	LRCLK hold (DSP serial port mode only)	5	ns
t _{DDS}	SDATA setup (see Figure 26)	5	ns
t _{DDH}	SDATA hold (see Figure 26)	10	ns
t _{RSTL}	RESET low pulse width	15	ns

¹ Higher MCLK frequencies are allowable when using the on-chip master clock autodivide feature.

ABSOLUTE MAXIMUM RATINGS

Table 9.

Parameter	Rating
DVDD to DGND	-0.3 V to +6 V
AVDD to AGND	-0.3 V to +6 V
Digital Inputs	DGND - 0.3 V to DVDD + 0.3 V
Analog Outputs	AGND - 0.3 V to AVDD + 0.3 V (see Figure 26)
AGND to DGND	-0.3 V to +0.3 V
Reference Voltage	(AVDD + 0.3 V)/2 V
Soldering	300°C 10 sec

Stresses above those listed under Absolute Maximum Ratings may cause permanent damage to the device. This is a stress rating only; functional operation of the device at these or any other conditions above those indicated in the operational section of this specification is not implied. Exposure to absolute maximum rating conditions for extended periods may affect device reliability.

THERMAL RESISTANCE

θ_{JA} is specified for the worst-case conditions, that is, a device soldered in a circuit board for surface-mount packages.

Table 10.

Package Type	θ_{JA}	θ_{JC}	Unit
Thermal Resistance			
Junction-to-Ambient	109		°C/W
Junction-to-Case		39	°C/W

ESD CAUTION



ESD (electrostatic discharge) sensitive device.

Charged devices and circuit boards can discharge without detection. Although this product features patented or proprietary protection circuitry, damage may occur on devices subjected to high energy ESD. Therefore, proper ESD precautions should be taken to avoid performance degradation or loss of functionality.

PIN CONFIGURATION AND FUNCTION DESCRIPTIONS

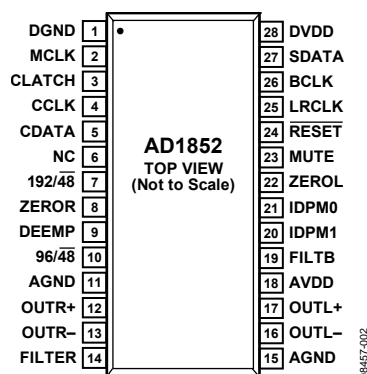

Figure 2. Pin Configuration

Table 11. Pin Function Descriptions

Pin No.	Mnemonic	Input/Output	Description
1	DGND	I	Digital Ground.
2	MCLK	I	Master Clock Input. Connect to an external clock source running at either 256 fs, 384 fs, 512 fs, 768 fs, or 1024 fs.
3	CLATCH	I	Latch Input for SPI Control Data Port. This input is rising-edge sensitive.
4	CCLK	I	SPI Control Clock Input for Control Data. Control input data must be valid on the rising edge of CCLK. CCLK may be continuous or gated.
5	CDATA	I	SPI Control Data Input, MSB First. SPI data port for controlling AD1852 functions as described in the SPI Register Definitions section.
6	NC		No Connect.
7	192/48	I	192 kHz/48 kHz Hardware Sample Rate Selection. When it is asserted high, this pin selects 192 kHz. When it is asserted low, this pin selects 48 kHz. It is OR'd with Bit 11 of the control register.
8	ZEROR	O	Right Channel Zero Flag Output. This pin goes high when the right channel has no signal input for more than 1024 LR clock cycles.
9	DEEMP	I	De-Emphasis. Digital de-emphasis is enabled when this input signal is high. This is used to impose a 50 μs/15 μs response characteristic on the output audio spectrum at an assumed 44.1 kHz sample rate. Curves for 32 kHz and 48 kHz sample rates may be selected via the SPI control register.
10	96/48	I	96 kHz/48 kHz Hardware Sample Rate Selection. When it is asserted high, this pin selects 96 kHz. When it is asserted low, this pin selects 48 kHz. It is OR'd with Bit 10 of the control register.
11, 15	AGND	I	Analog Ground.
12	OUTR+	O	Right Channel Positive Line Level Analog Output.
13	OUTR-	O	Right Channel Negative Line Level Analog Output.
14	FILTR	O	Voltage Reference Filter Capacitor Connection. Bypass and decouple the voltage reference with parallel 10 μF and 0.1 μF capacitors to the AGND.
16	OUTL-	O	Left Channel Negative Line Level Analog Output.
17	OUTL+	O	Left Channel Positive Line Level Analog Output.
18	AVDD	I	Analog Power Supply. Connect this pin to the analog 5 V supply.
19	FILTB		Filter Capacitor Connection. Connect 10 μF 10 nF capacitor to AGND (Pin 15).
20	IDPM1	I	Input Serial Data Port Mode Control One. With IDPM0, defines 1 of 4 serial modes.
21	IDPM0	I	Input Serial Data Port Mode Control Zero. With IDPM1, defines 1 of 4 serial modes.
22	ZEROL	O	Left Channel Zero Flag Output. This pin goes high when the left channel has no signal input for more than 1024 LR clock cycles.
23	MUTE	I	Mute. Assert this pin high to mute both stereo analog outputs. De-assert low for normal operation.
24	RESET	I	Reset. The AD1852 is reset on the rising edge of this signal. The serial control port registers are reset to the default values. For normal operation, assert this pin high.

AD1852

Pin No.	Mnemonic	Input/Output	Description
25	LRCLK	I	Left/Right Clock Input for Serial Audio Data Input Port. This pin must run continuously.
26	BCLK	I	Bit Clock Input for Serial Audio Data Input Port. This pin need not run continuously; may be gated or used in a burst fashion.
27	SDATA	I	Serial Audio Data Input, MSB First. Input for the serial audio data stream is as described the in Serial Data Input Port section.
28	DVDD	I	Digital Power Supply. Connect this pin to the digital 5 V supply.

Table 12. Serial Data Input Mode

IDPM1 (Pin 20)	IDPM0 (Pin 21)	Serial Data Input Format
0	0	Right justified
0	1	I ² S compatible
1	0	Left justified
1	1	DSP

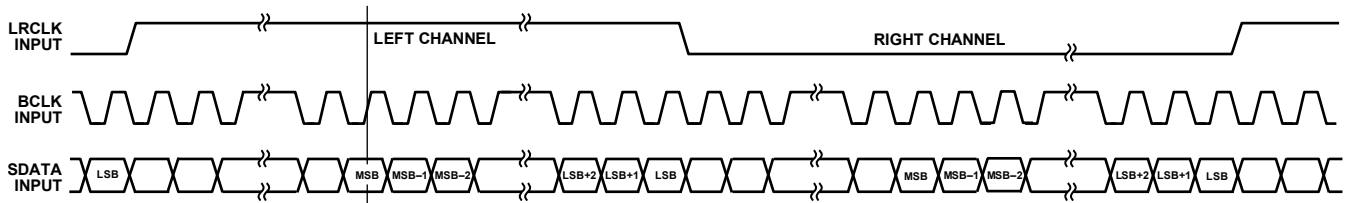

08457-003

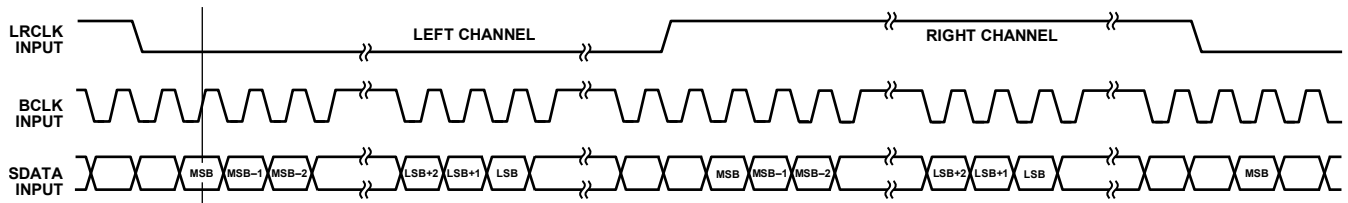

08457-004

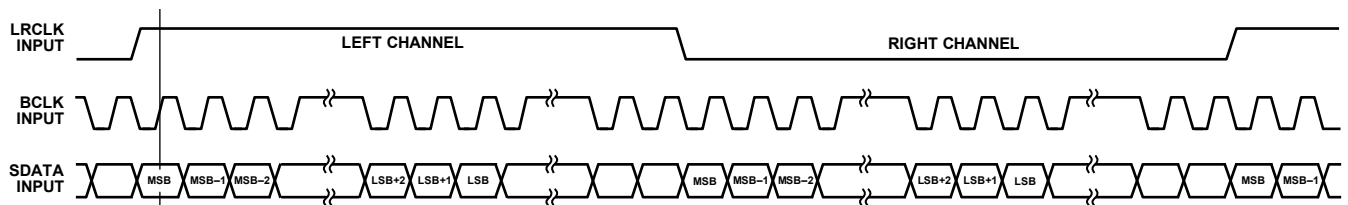

08457-005

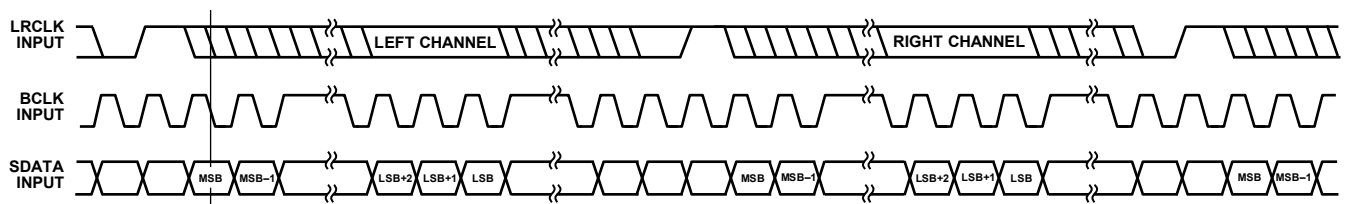

08457-006

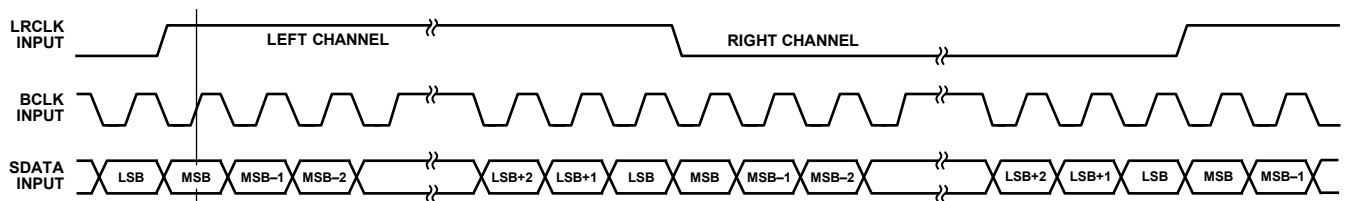

08457-007

TYPICAL PERFORMANCE CHARACTERISTICS

Figure 8 to Figure 13 show the calculated frequency response of the digital interpolation filters. Figure 14 to Figure 25 show the performance of the AD1852 as measured by an Audio Precision System 2 Cascade. For the wideband plots, the noise floor shown in the plots is higher than the actual noise floor of the AD1852. This is caused by the higher noise floor of the high bandwidth ADC used in the Audio Precision measurement system. The two-tone test shown in Figure 16 is per the SMPTE standard for measuring intermodulation distortion.

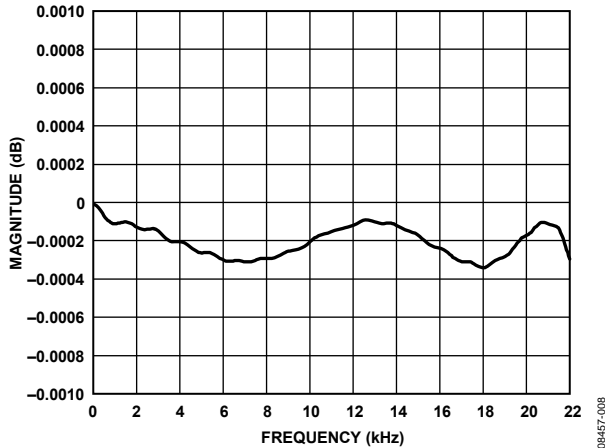

Figure 8. Pass-Band Response 8x Mode, 48 kHz Sample Rate

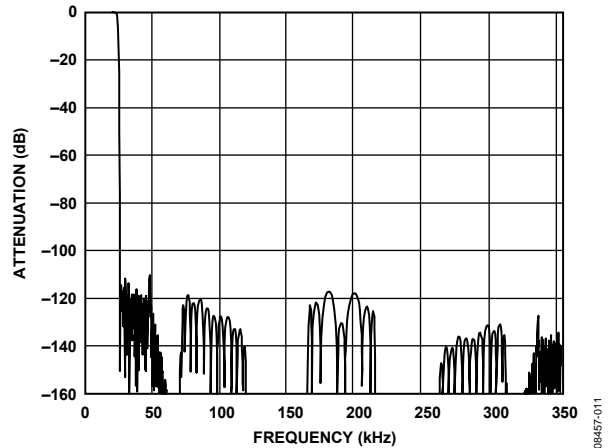

Figure 11. Complete Response, 8x Mode, 48 kHz Sample Rate

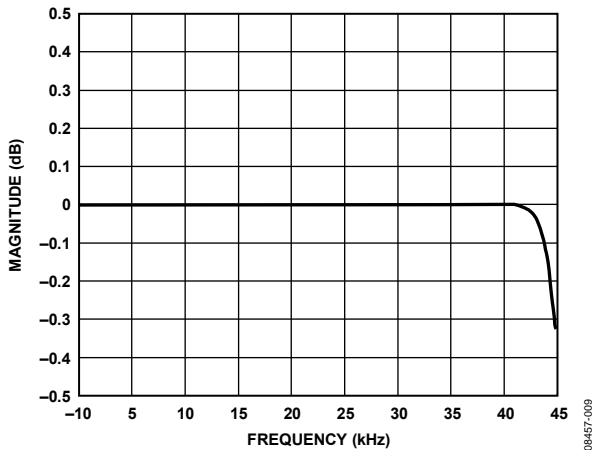

Figure 9. 44 kHz Pass-Band Response 4x Mode, 96 kHz Sample Rate

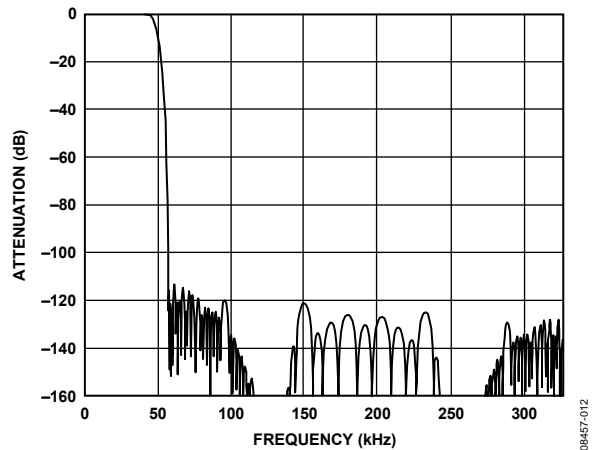

Figure 12. Complete Response, 4x Mode, 96 kHz Sample Rate

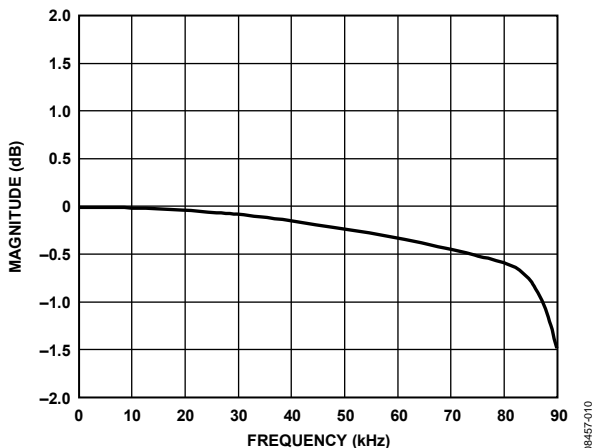

Figure 10. 88 kHz Pass-Band Response 2x Mode, 192 kHz Sample Rate

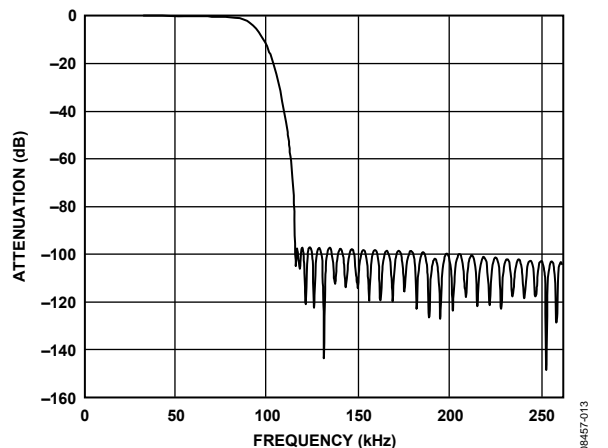

Figure 13. Complete Response, 2x Mode, 192 kHz Sample Rate

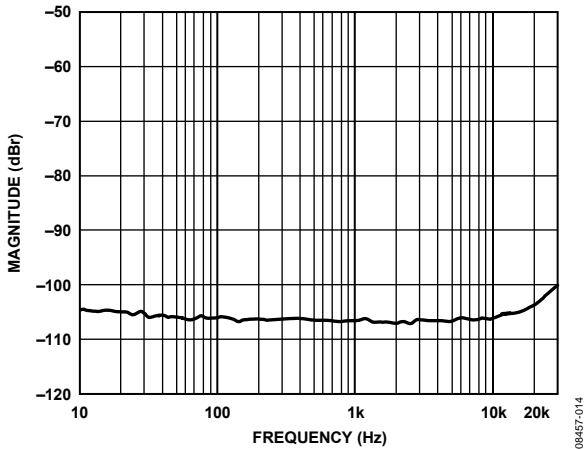

Figure 14. THD vs. Frequency Input @ -3 dBFS, SR 48 kHz

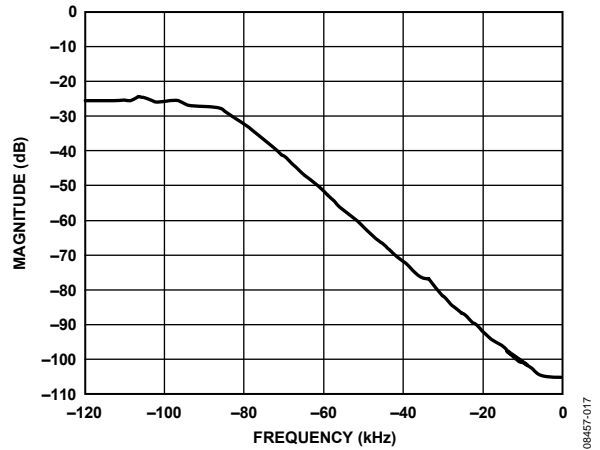

Figure 17. THD + N Ratio vs. Amplitude Input 1 kHz, SR 48 kS/s, 24-Bit

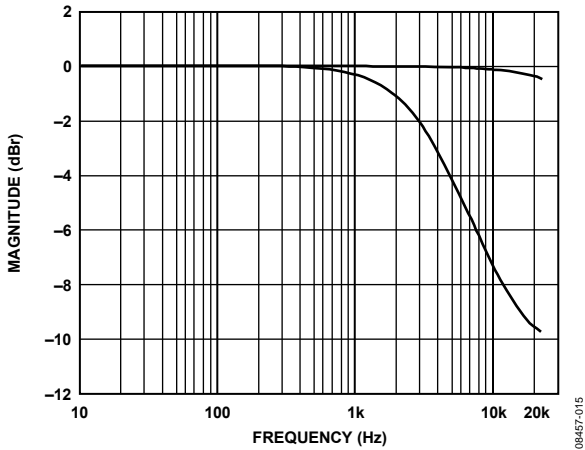

Figure 15. Normal De-Emphasis Frequency Response Input @ -10 dBFS, SR 48 kHz

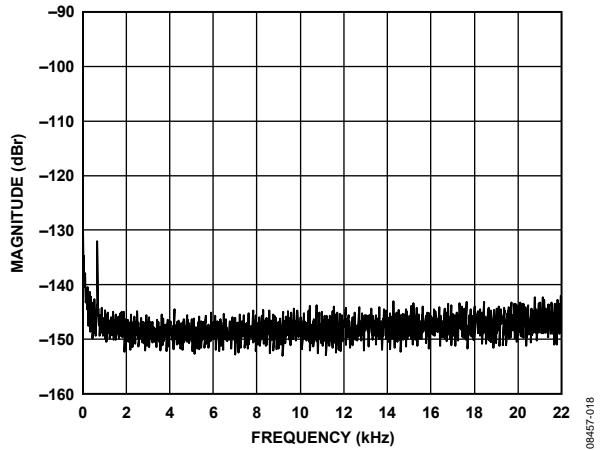

Figure 18. Noise Floor for Zero Input, SR 48 kHz

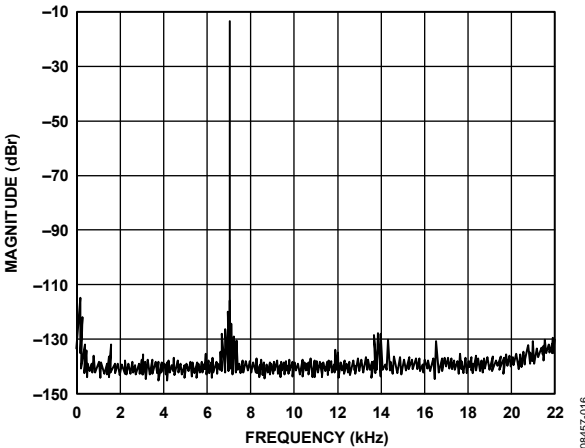

Figure 16. SMPTE/DIN 4:1 IMD 60 Hz/7 kHz @ 0 dBFS

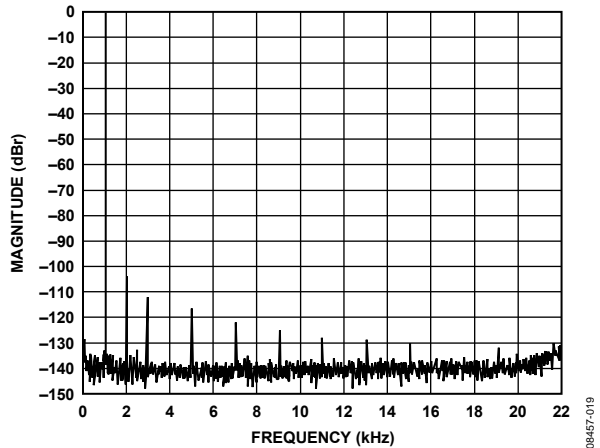

Figure 19. Input 0 dBFS @ 1 kHz, BW 10 Hz to 22 kHz, SR 48 kHz

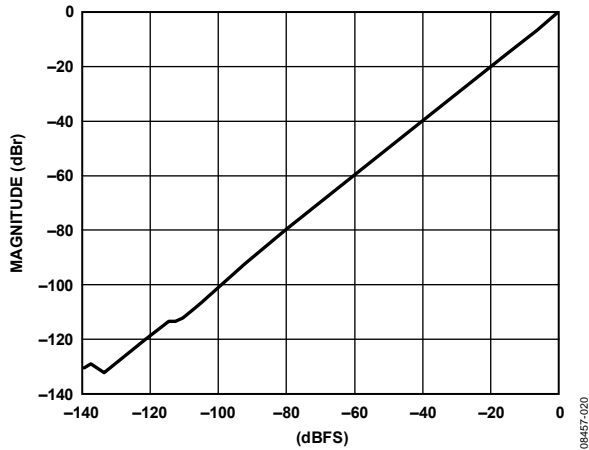

Figure 20. Linearity vs. Amplitude Input 200 Hz, SR 48 kS/s, 24-Bit Word

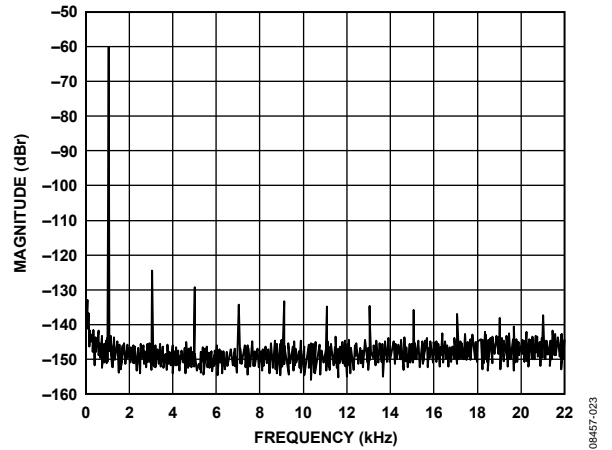

Figure 23. Dynamic Range for 1 kHz @ -60 dBFS, Triangular Dithered Input

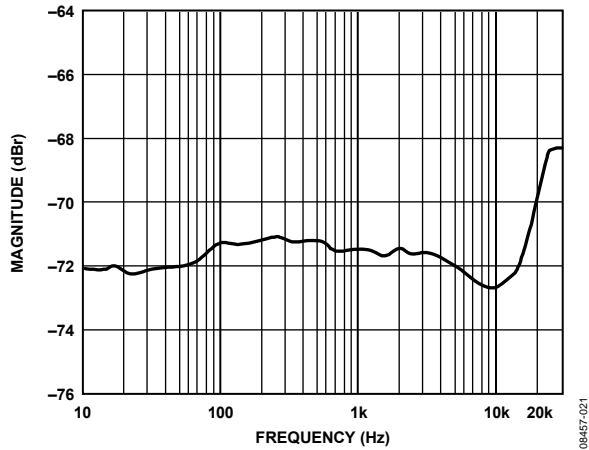

Figure 21. Power Supply Rejection vs. Frequency, AVDD 5 V DC + 100 mV p-p AC

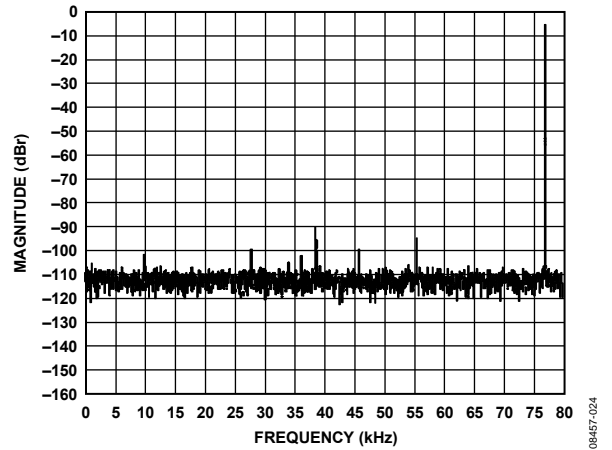

Figure 24. Wideband Plot, 75 kHz Input, 2x Interpolation, SR 192 kHz

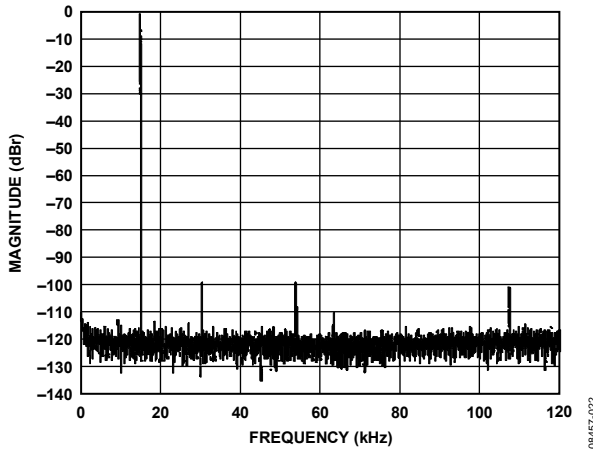

Figure 22. Wideband Plot, 15 kHz Input, 8x Interpolation, SR 48 kHz

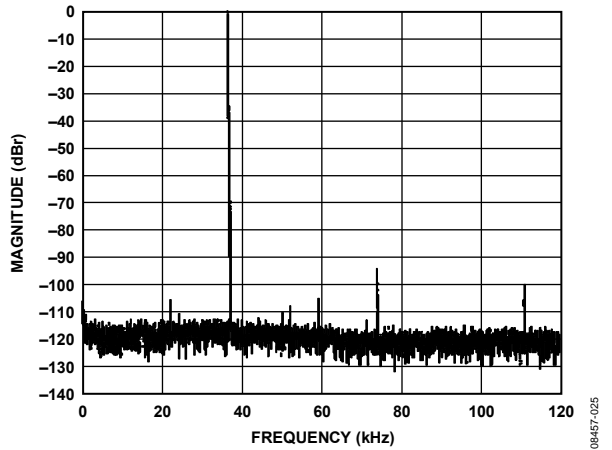

Figure 25. Wideband Plot, 37 kHz Input, 4x Interpolation, SR 96 kHz

THEORY OF OPERATION

SERIAL DATA INPUT PORT

The flexible, serial data input port of the AD1852 accepts data in twos-complement, MSB-first format. The left channel data field always precedes the right channel data field. The serial mode is set by either using the external mode pins (IDPM0, Pin 21 and IDPM1, Pin 20) or the mode select bits (Bit 4 and Bit 5) in the SPI control register. To control the serial mode using the external mode pins, the SPI mode select bits should be set to zero (the default mode at power-up). To control the serial mode using the SPI mode select bits, the external mode control pins should be grounded.

In all modes, except for right-justified mode, the serial port accepts an arbitrary number of bits up to 24. Extra bits do not cause an error, but they are truncated internally. In right-justified mode, use Bit 8 and Bit 9 of the SPI control register to set the word length to 16 bits, 20 bits, or 24 bits. The default mode at power-up is 24-bit mode. When the SPI control port is not being used, the SPI pins (CLATCH, CCLK, and CDATA [Pin 3, Pin 4, and Pin 5]) should be tied low.

SERIAL DATA INPUT MODE

The AD1852 uses two multiplexed input pins to control the mode configuration of the input data port mode (see Table 12).

Figure 3 shows the right-justified mode (16 bits shown). LRCLK is high for the left channel and low for the right channel. Data is valid on the rising edge of BCLK.

In normal operation, there are 64-bit clocks per frame (or 32 per half frame). When the SPI word length control bits (Bit 8 and Bit 9 in the SPI control register) are set to 24 bits (0:0), the serial port begins to accept data starting at the eighth bit clock pulse after the LRCLK transition. When the word length control bits are set to 20-bit mode, data is accepted starting at the 12th bit clock position. In 16-bit mode, data is accepted starting at the 16th bit clock position. These delays are independent of the number of bit clocks per frame, and therefore, other data formats are possible using the delay values previously described. For detailed timing, see Figure 26.

Figure 4 shows the I²S mode. LRCLK is low for the left channel and high for the right channel. Data is valid on the rising edge of BCLK. The MSB is left justified to an LRCLK transition but with a single BCLK period delay. The I²S mode can be used to accept any number of bits up to 24.

Figure 5 shows the left-justified mode. LRCLK is high for the left channel, and low for the right channel. Data is valid on the rising edge of BCLK. The MSB is left justified to an LRCLK transition, with no MSB delay. The left-justified mode can accept any word length up to 24 bits, and any number of bit clocks from two times the word length to 64-bit clocks per frame.

Figure 6 shows the DSP serial port mode. LRCLK must pulse high for at least one bit clock period before the MSB of the left channel is valid, and LRCLK must pulse high again for at least one bit clock period before the MSB of the right channel is valid. Data is valid on the falling edge of BCLK. The DSP serial port mode can be used with any word length up to 24 bits.

In this mode, it is the responsibility of the DSP to ensure that the left data is transmitted with the first LRCLK pulse and that synchronism is maintained from that point forward.

Note that the AD1852 is capable of a $32 \times f_s$ BCLK frequency packed mode, where the MSB is left justified to an LRCLK transition, and the LSB is right justified to the opposite LRCLK transition. LRCLK is high for the left channel and low for the right channel. Data is valid on the rising edge of BCLK. Packed mode can be used when the AD1852 is programmed in right-justified or left-justified mode. Packed mode is shown in Figure 7.

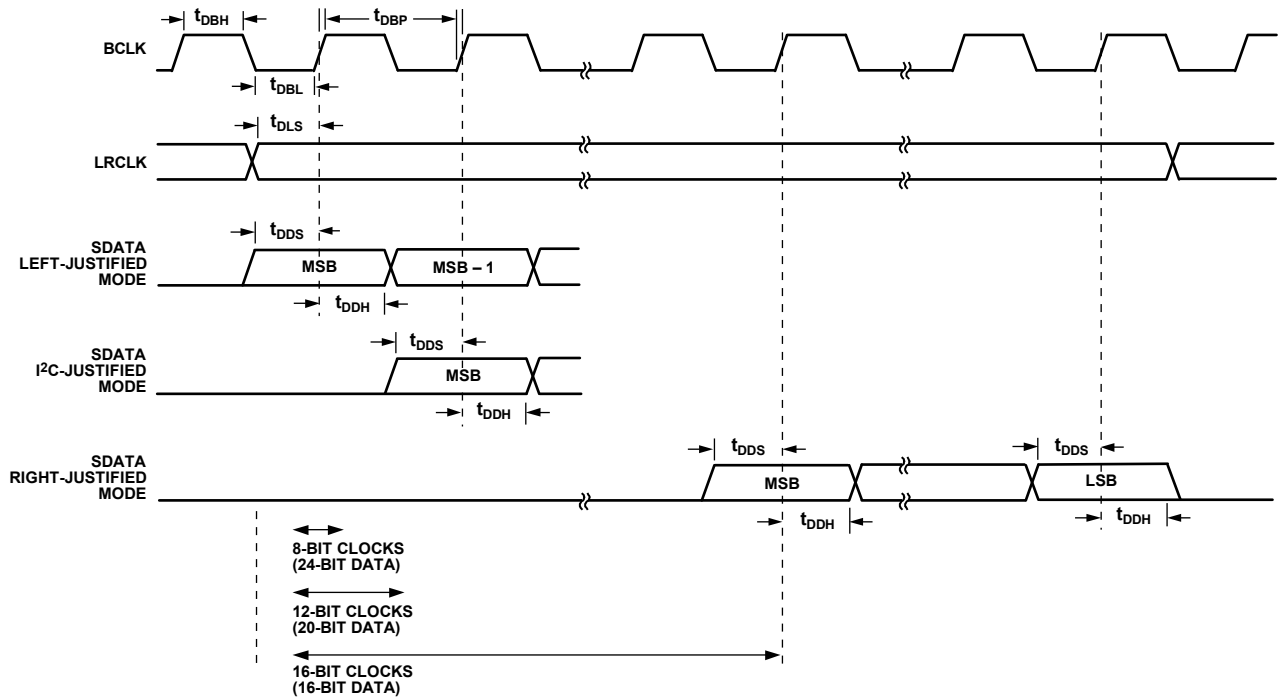

Figure 26. Serial Data Port Timing

08457-026

Table 13. Allowable MCLK Frequencies and Internal Delta Clock Rates

Chip Mode	Allowable Master Clock Frequencies	Nominal Input Sample Rate (kHz)	Internal Sigma-Delta Clock Rate
INT 8× Mode	$256 \times f_s, 384 \times f_s, 512 \times f_s, 768 \times f_s, 1024 \times f_s$	48	$128 \times f_s$
INT 4× Mode	$128 \times f_s, 192 \times f_s, 256 \times f_s, 384 \times f_s, 512 \times f_s$	96	$64 \times f_s$
INT 2× Mode	$64 \times f_s, 96 \times f_s, 128 \times f_s, 192 \times f_s, 256 \times f_s$	192	$32 \times f_s$

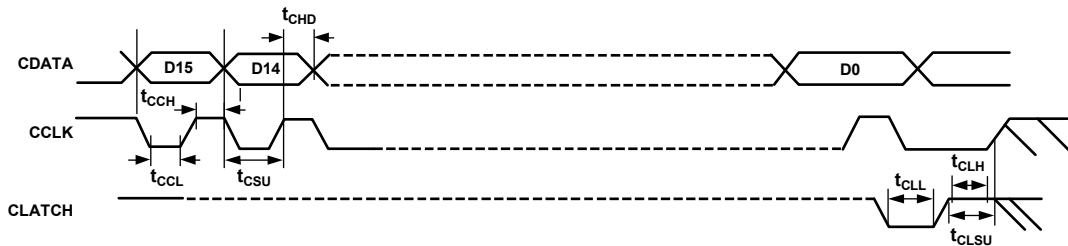

Figure 27. Serial Control Port Timing

08457-027

MASTER CLOCK AUTODIVIDE FEATURE

The AD1852 has a circuit that autodetects the relationship between the master clock and the incoming serial data and internally sets the correct divide ratio to run the interpolator and modulator. The allowable frequencies for each mode are shown in Table 13. Master clock should be synchronized with LRCLK; however, phase relation between master clock and LRCLK is not critical.

SPI REGISTER DEFINITIONS

The SPI port allows flexible control of many chip parameters. It is organized around three registers: a left-channel volume register, a right-channel volume register, and a control register. Each write operation to the AD1852 SPI control port requires 16 bits of serial data in MSB-first format. The bottom two bits are used to select one of three registers, and the top 14 bits are then written to that register. This allows a write to one of the three registers in a single 16-bit transaction.

The SPI CCLK signal is used to clock in the data. The incoming data should change on the falling edge of this signal. At the end of the 16 CCLK periods, the CLATCH signal should rise to clock the data internally into the AD1852.

The serial control port timing is shown in Figure 27, and the SPI digital timing values are listed in Table 14.

Table 14. SPI Digital Timing

Parameter	Description	Value
tCCH	CCLK high pulse width	40 ns
tCCL	CCLK low pulse width	40 ns
tCSU	CDATA setup time	10 ns
tCHD	CDATA hold time	10 ns
tCLL	CLATCH low pulse width	10 ns
tCLH	CLATCH high pulse width	10 ns
tCLSU	CLATCH setup time	$4 \times t_{MCLK}$

REGISTER ADDRESSES

The lowest two bits of the 16-bit serial control data word are decoded as the address of the register into which the upper 14 bits are written. These bits are defined in Table 15.

Table 15. AD1852 Registers

Bit 1	Bit 0	Register
0	0	Volume left
1	0	Volume right
0	1	Control register

VOLUME LEFT AND VOLUME RIGHT REGISTERS

A write operation to the left or right volume registers activates the autoramp, clickless volume control feature of the AD1852. The upper 10 bits of the volume control word increment or decrement by 1 at a rate equal to the input sample rate. The bottom four bits are not fed into the autoramp circuit and thus take effect immediately. This arrangement gives a worst-case ramp time of about 20 ms for step changes of more than 60 dB, which was determined by listening tests to be optimal in terms of preventing the perception of a click sound on large volume changes. See Figure 28 for a graphical description of how the volume changes as a function of time.

The 14-bit volume control word is used to multiply the signal, and therefore, the control characteristic is linear, not dB. A constant dB/step characteristic can be obtained by using a lookup table in the microprocessor that is writing to the SPI port. The volume word is unsigned (that is, 0 dB is 11 1111 1111 1111).

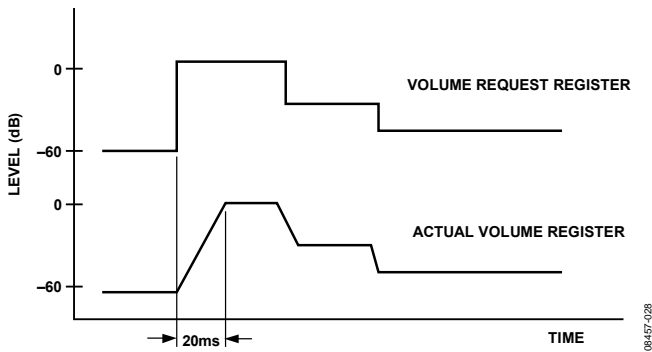

Figure 28. Smooth Volume Control

SPI TIMING

The SPI port is a 3-wire interface with serial data (CDATA), serial bit clock (CCLK), and data latch (CLATCH). The data is clocked into an internal shift register on the rising edge of CCLK. The serial data should change on the falling edge of CCLK and be stable on the rising edge of CCLK. The rising edge of CLATCH is used internally to latch the parallel data from the serial-to-parallel converter. This rising edge should be aligned with the falling edge of the last CCLK pulse in the 16-bit frame. The CCLK can run continuously between transactions.

Note that the serial control port timing is asynchronous to the serial data port timing. Changes made to the attenuator level update on the next edge of the LRCLK after the CLATCH write pulse, as shown in Figure 27.

MUTE

The AD1852 offers two methods of muting the analog output. By asserting the MUTE (Pin 23) signal high, both the left and right channel are muted. As an alternative, the user can assert the mute bit in the serial control register (Bit 6) high. The AD1852 was designed to minimize pops and clicks when muting and unmuting the device by automatically ramping the gain up or down. When the device is unmuted, the volume returns to the value set in the volume register.

CONTROL REGISTER

Table 16 shows the functions of the control register. The control register is addressed by having a 01 in the bottom two bits of the 16-bit SPI word. The top 14 bits are then used for the control register.

DE-EMPHASIS

The AD1852 has a built-in, de-emphasis filter that can be used to decode CDs that have been encoded with the standard Red Book 50 μ s/15 μ s emphasis response curve. Three curves are available; one each for the 32 kHz, 44.1 kHz, and 48 kHz sampling rates. The external DEEMP pin (Pin 9) turns on the 44.1 kHz de-emphasis filter. The other filters may be selected by writing to Control Bit 2 and Control Bit 3 in the control register. If the SPI port is used to control the de-emphasis filter, the external DEEMP pin should be tied low.

OUTPUT IMPEDANCE

The output impedance of the AD1852 is $65 \Omega \pm 30\%$.

RESET

The AD1852 may be reset either by a dedicated hardware pin (RESET, Pin 24) or by software via the SPI control port. When reset is active, normal operation of the AD1852 is suspended, and the outputs assume midscale values. The AD1852 should always be reset at power up. The RESET function should be active for a minimum of 64 master clock periods. When the RESET function becomes inactive, normal operation continues after a delay equal to the group delay, plus three MCLK periods.

Using the RESET pin, the internal registers are set to their default values, when the RESET pin is active low. When RESET rises, the default operation is enabled. Alternatively, the internal registers can be reset to their default values by setting Bit 7 of the internal control register high. When Bit 7 is reset low, default operation continues. The software reset differs from the hardware reset because the soft reset does not affect the values stored in the SPI registers.

CONTROL SIGNALS

The IDPM0 and IDPM1 control inputs are normally connected high or low to establish the operating state of the AD1852, as described in Table 12. They can be changed dynamically (and asynchronously to LRCLK and the master clock), but it is possible that a click or pop sound will result during the transition from one serial mode to another. If possible, the AD1852 should be placed in mute before such a change is made.

Table 16. Control Register Functions

Bit Number	Function
Bit 11	INT 2 \times mode OR'd with Pin 7 (192/48); default = 0
Bit 10	INT 4 \times mode OR'd with Pin 10 (96/48); default = 0
Bit 9:8	Number of bits in right-justified serial mode 0:0 = 24 0:1 = 20 1:0 = 16 Default = 0:0
Bit 7	Reset; default = 0
Bit 6	Soft mute OR'd with pin; default = 0
Bit 5:4	Serial mode OR'd with mode pins; IDPM1:IDPM0 0:0 = right-justified 0:1 = I ² S 1:0 = left-justified 1:1 = DSP mode Default = 0:0
Bit 3:2	De-emphasis filter select 0:0 = no filter 0:1 = 44.1 kHz filter 1:0 = 32 kHz filter 1:1 = 48 kHz filter Default = 0:0

AD1852

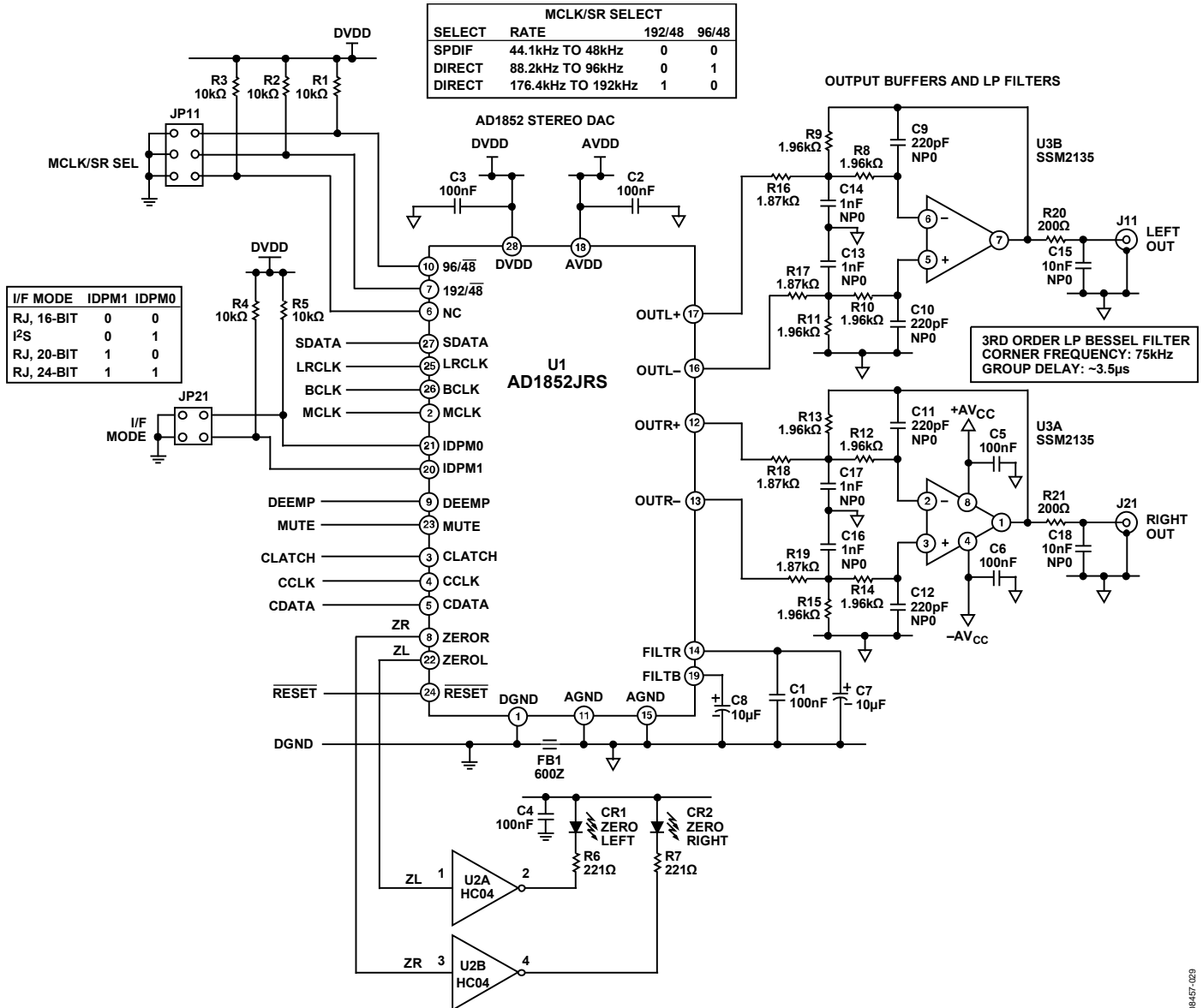

Figure 29. DAC, Output Buffers, and LP Filters

09457-029

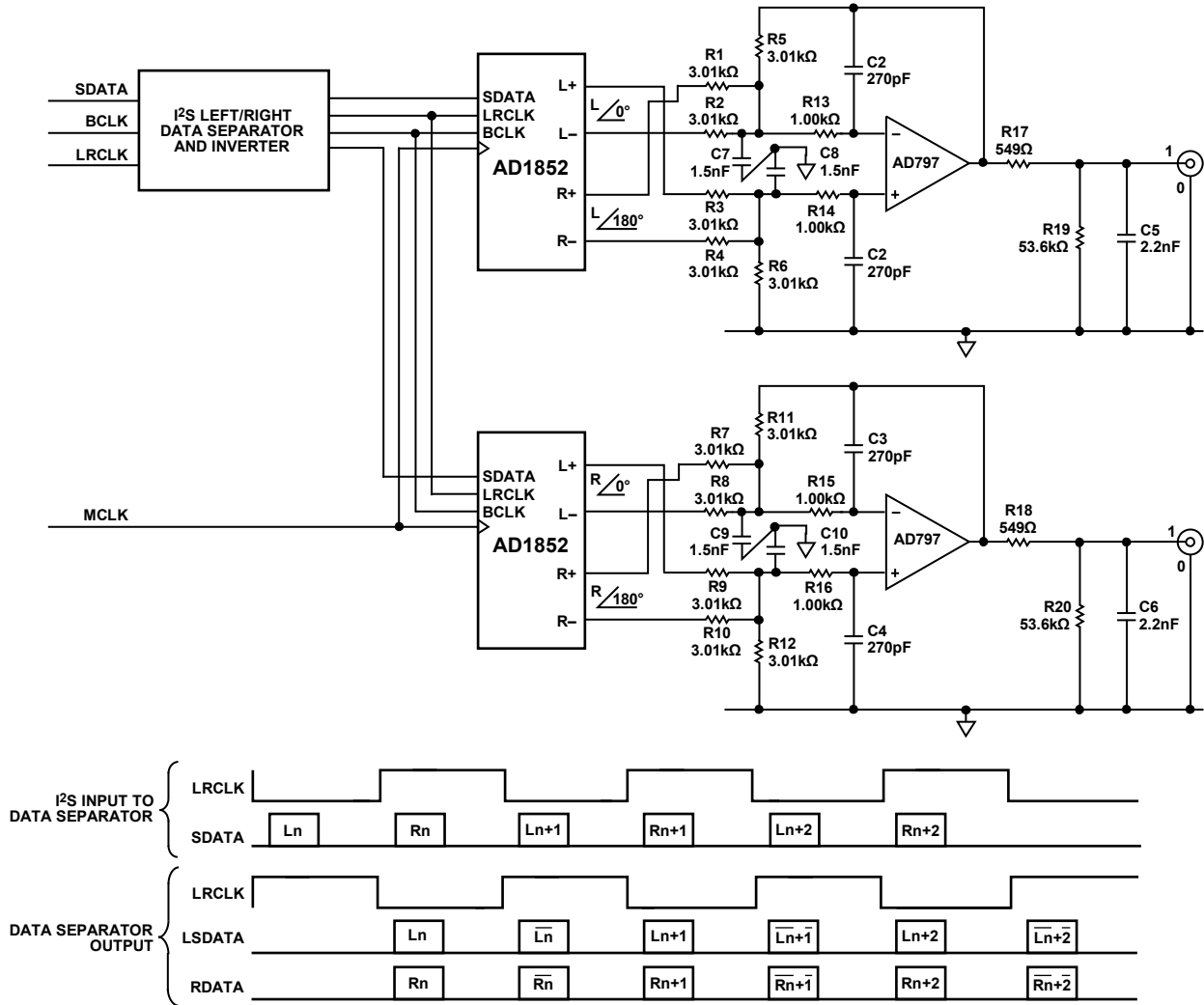
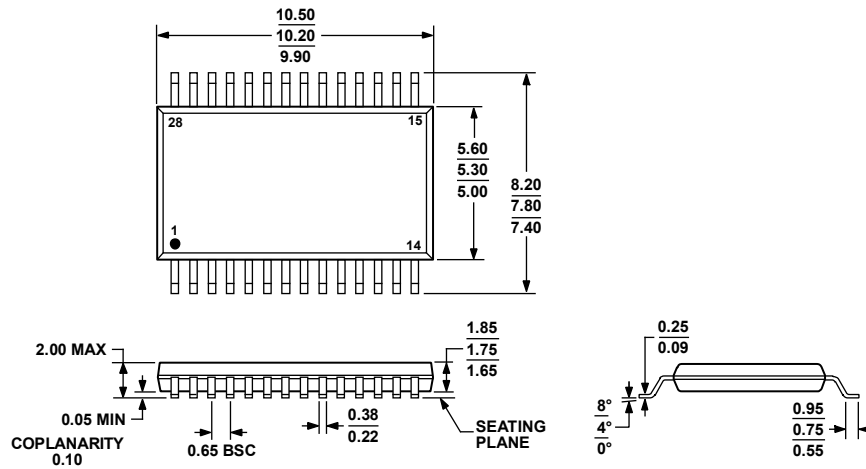

Figure 30. Mono Application Circuit

08457-030

OUTLINE DIMENSIONS



COMPLIANT TO JEDEC STANDARDS MO-150-AH

Figure 31. 28-Lead Shrink Small Outline Package [SSOP] (RS-28)

Dimensions shown in millimeters

060106-A

ORDERING GUIDE

Model	Temperature Range	Package Description	Package Option
AD1852JRSZ ¹	0°C to 70°C	28-Lead Shrink Small Outline Package [SSOP]	RS-28
AD1852JRSZRL ¹	0°C to 70°C	28-Lead Shrink Small Outline Package [SSOP], 13" Tape and Reel	RS-28
EVAL-AD1852EBZ ¹		Evaluation Board	

¹ Z = RoHS Compliant Part.

NOTES

AD1852

NOTES

AMEYA360

Components Supply Platform

Authorized Distribution Brand :



Website :

Welcome to visit www.ameya360.com

Contact Us :

➤ Address :

401 Building No.5, JiuGe Business Center, Lane 2301, Yishan Rd
Minhang District, Shanghai , China

➤ Sales :

Direct +86 (21) 6401-6692

Email amall@ameya360.com

QQ 800077892

Skype [ameyasales1](#) [ameyasales2](#)

➤ Customer Service :

Email service@ameya360.com

➤ Partnership :

Tel +86 (21) 64016692-8333

Email mkt@ameya360.com