

150 mA low quiescent current low noise voltage regulator

Datasheet - production data

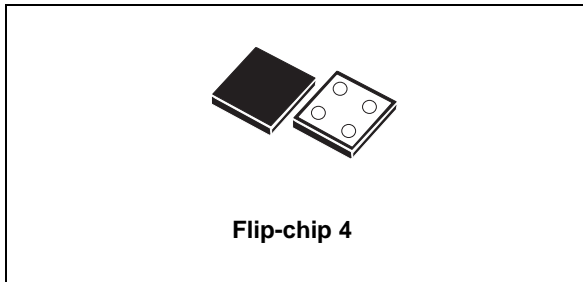

Features

- Input voltage from 1.5 to 5.5 V
- Ultra low dropout voltage (80 mV typ. at 100 mA load)
- Very low quiescent current (20 μ A typ. at no load, 35 μ A typ. at 150 mA load, 1 μ A max in off mode)
- Very low noise (33 μ V_{RMS} from 1 kHz to 100 kHz at $V_{OUT} = 1.8$ V)
- Output voltage tolerance: ± 2.0 % @ 25 °C
- 150 mA guaranteed output current
- Wide range of output voltages available on request: 0.8 V to 4.5 V with 100 mV step
- Logic-controlled electronic shutdown
- Compatible with ceramic capacitor $C_{OUT} = 1$ μ F

- Internal current and thermal limit
- Flip-chip 4 bumps 0.8 x 0.8 mm. pitch 0.4 mm
- Temperature range: -40 °C to 125 °C

Applications

- Mobile phones
- Personal digital assistants (PDAs)
- Cordless phones and similar battery-powered systems

Description

The LD39115J provides 150 mA maximum current from an input voltage ranging from 1.5 V to 5.5 V with a typical dropout voltage of 80 mV. It is stabilized with a ceramic capacitor. The ultra low drop voltage, low quiescent current and low noise features make it suitable for low power battery-powered applications. Power supply rejection is 65 dB at low frequencies and starts to roll off at 10 kHz. An enable logic control function puts the LD39115J in shutdown mode allowing a total current consumption lower than 1 μ A. The device also includes a short-circuit constant current limiting and thermal protection.

Table 1. Device summary

Order codes	Output voltages
LD39115J10R	1 V
LD39115J12R	1.2 V
LD39115J14R	1.4 V
LD39115J15R	1.5 V
LD39115J18R	1.8 V
LD39115J25R	2.5 V
LD39115J28R	2.8 V
LD39115J30R	3.0 V
LD39115J33R	3.3 V

Contents

1	Diagram	3
2	Pin configuration	4
3	Typical application	5
4	Maximum ratings	6
5	Electrical characteristics	7
6	Typical performance characteristics	9
7	Package mechanical data	15
8	Packaging mechanical data	17
9	Different output voltage versions of the LD39115J available on request	19
10	Revision history	20

1 Diagram

Figure 1. Block diagram

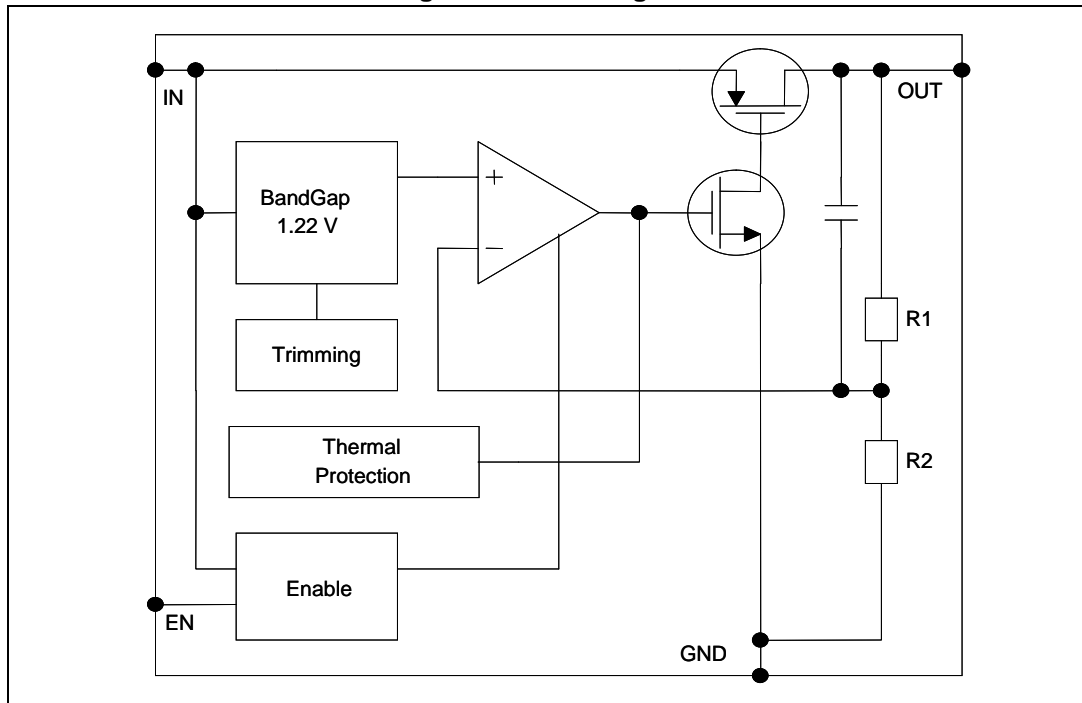

2 Pin configuration

Figure 2. Pin connection (top view)

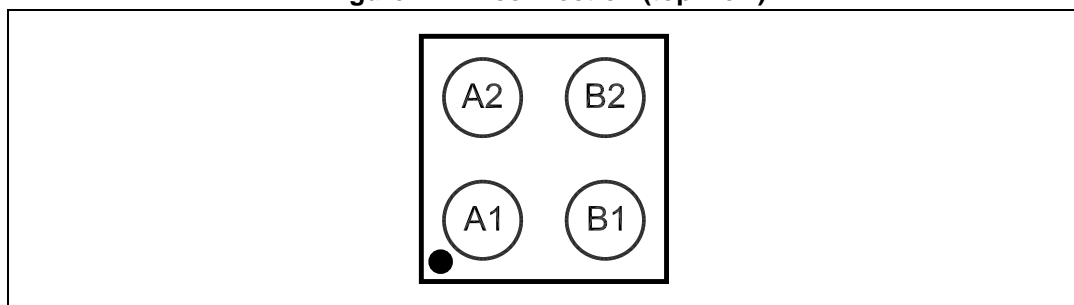
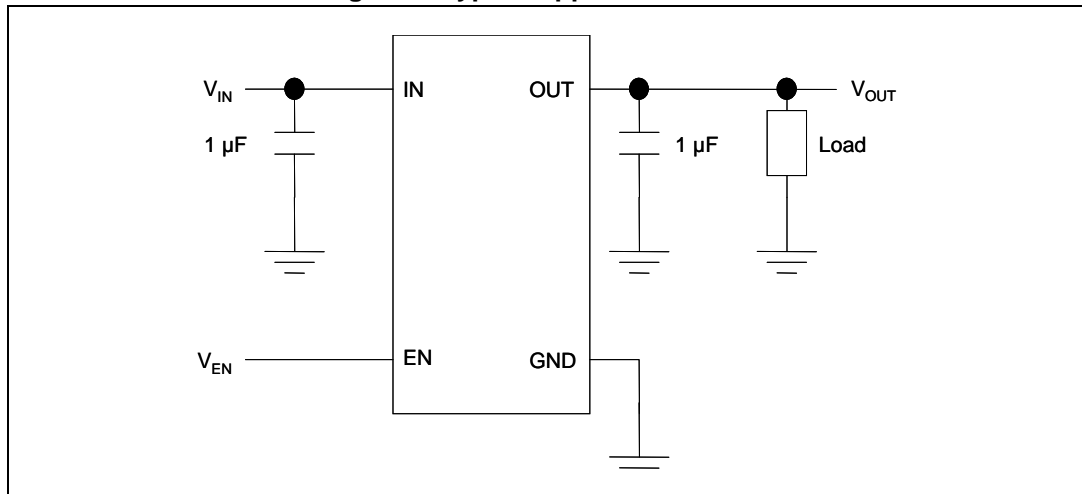

Table 2. Pin description

Pin n°	Symbol	Function
A2	EN	Enable pin logic input: Low = shutdown, High = active
A1	GND	Common ground
B2	IN	Input voltage of the LDO
B1	OUT	Output voltage

3 Typical application

Figure 3. Typical application circuit



4 Maximum ratings

Table 3. Absolute maximum ratings

Symbol	Parameter	Value	Unit
V_{IN}	DC input voltage	- 0.3 to 6	V
V_{OUT}	DC output voltage	- 0.3 to $V_I + 0.3$	V
V_{EN}	Enable input voltage	- 0.3 to $V_I + 0.3$	V
I_{OUT}	Output current	Internally limited	mA
P_D	Power dissipation	Internally limited	mW
T_{STG}	Storage temperature range	- 65 to 150	°C
T_{OP}	Operating junction temperature range	- 40 to 125	°C

Note: Absolute maximum ratings are those values beyond which damage to the device may occur. Functional operation under these conditions is not implied. All values are referred to GND.

Table 4. Thermal data

Symbol	Parameter	Value	Unit
R_{thJA}	Thermal resistance junction-ambient	180	°C/W

5 Electrical characteristics

$T_J = 25\text{ °C}$, $V_{IN} = V_{OUT(NOM)} + 1\text{ V}$, $C_{IN} = C_{OUT} = 1\text{ }\mu\text{F}$, $I_{OUT} = 1\text{ mA}$, $V_{EN} = V_{IN}$, unless otherwise specified.

Table 5. Electrical characteristics for LD39115J (1)

Symbol	Parameter	Test conditions	Min.	Typ.	Max.	Unit
V_{IN}	Operating input voltage		1.5		5.5	V
V_{UVLO}	Turn-on threshold			1.45	1.48	V
	Turn-off threshold		1.30	1.35		mV
V_{OUT}	V_{OUT} accuracy	$V_{OUT} > 1.5\text{ V}$, $I_{OUT} = 1\text{ mA}$, $T_J = 25\text{ °C}$	-2.0		2.0	%
		$V_{OUT} > 1.5\text{ V}$, $I_{OUT} = 1\text{ mA}$, $-40\text{ °C} < T_J < 125\text{ °C}$	-3.0		3.0	%
		$V_{OUT} \leq 1.5\text{ V}$, $I_{OUT} = 1\text{ mA}$		± 10		mV
		$V_{OUT} \leq 1.5\text{ V}$, $I_{OUT} = 1\text{ mA}$, $-40\text{ °C} < T_J < 125\text{ °C}$		± 30		mV
ΔV_{OUT}	Static line regulation	$V_{OUT} + 1\text{ V} \leq V_{IN} \leq 5.5\text{ V}$, $I_{OUT} = 1\text{ mA}$		0.01		%/V
ΔV_{OUT}	Transient line regulation ⁽²⁾	$\Delta V_{IN} = +500\text{ mV}$, $I_{OUT} = 1\text{ mA}$, $T_R = T_F = 5\text{ }\mu\text{s}$		10		mVpp
ΔV_{OUT}	Static load regulation	$I_{OUT} = 1\text{ mA}$ to 150 mA		0.002		%/mA
ΔV_{OUT}	Transient load regulation ⁽²⁾	$I_{OUT} = 1\text{ mA}$ to 150 mA , $t_R = t_F = 5\text{ }\mu\text{s}$		40		mVpp
V_{DROP}	Dropout voltage ⁽³⁾	$I_{OUT} = 100\text{ mA}$, $V_{OUT} > 1.5\text{ V}$ $-40\text{ °C} < T_J < 125\text{ °C}$		80	110	mV
e_N	Output noise voltage	10 Hz to 100 kHz, $I_{OUT} = 10\text{ mA}$		30		$\mu\text{V}_{RMS}/\text{V}$
SVR	Supply voltage rejection $V_{OUT} = 1.5\text{ V}$	$V_{IN} = V_{OUTNOM} + 1\text{ V} + /-V_{RIPPLE}$ $V_{RIPPLE} = 0.1\text{ V}$ Freq. = 1 kHz $I_{OUT} = 10\text{ mA}$		74		dB
		$V_{IN} = V_{OUTNOM} + 0.5\text{ V} + /-V_{RIPPLE}$ $V_{RIPPLE} = 0.1\text{ V}$ Freq. = 10 kHz $I_{OUT} = 10\text{ mA}$		67		
I_Q	Quiescent current	$I_{OUT} = 0\text{ mA}$		20		μA
		$I_{OUT} = 0\text{ mA}$, $-40\text{ °C} < T_J < 125\text{ °C}$			50	
		$I_{OUT} = 0$ to 150 mA		35		
		$I_{OUT} = 0$ to 150 mA , $-40\text{ °C} < T_J < 125\text{ °C}$			70	
		V_{IN} input current in OFF MODE: $V_{EN} = \text{GND}$		0.001	1	

Table 5. Electrical characteristics for LD39115J (continued)⁽¹⁾

Symbol	Parameter	Test conditions	Min.	Typ.	Max.	Unit
I _{SC}	Short circuit current	R _L = 0	200			mA
V _{EN}	Enable input logic low	V _{IN} = 1.5 V to 5.5 V, -40 °C < T _J < 125 °C			0.4	V
	Enable input logic high	V _{IN} = 1.5 V to 5.5 V, -40 °C < T _J < 125 °C	0.9			
I _{EN}	Enable pin input current	V _{SHDN} = V _{IN}		0.1	100	nA
T _{ON}	Turn on time ⁽⁴⁾			30		µs
T _{SHDN}	Thermal shutdown			160		°C
	Hysteresis			20		
C _{OUT}	Output capacitor	Capacitance (see Section 6: Typical performance characteristics)	1		22	µF

1. For V_{OUT(NOM)} < 1.2 V, V_{IN} = 1.5 V.
2. All transient values are guaranteed by design, not production tested.
3. Dropout voltage is the input-to-output voltage difference at which the output voltage is 100 mV below its nominal value. This specification does not apply for output voltages below 1.5 V.
4. Turn-on time is time measured between the enable input just exceeding V_{EN} high value and the output voltage just reaching 95 % of its nominal value.

6 Typical performance characteristics

$C_{IN} = C_{OUT} = 1 \mu F, V_{EN}$ to V_{IN} .

Figure 4. Output voltage vs. temperature ($V_{OUT} = 1.2 V$)

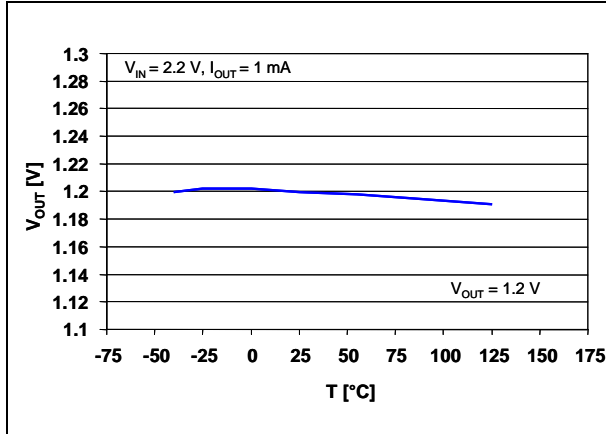

Figure 5. Output voltage vs. temperature ($V_{OUT} = 2.8 V$)

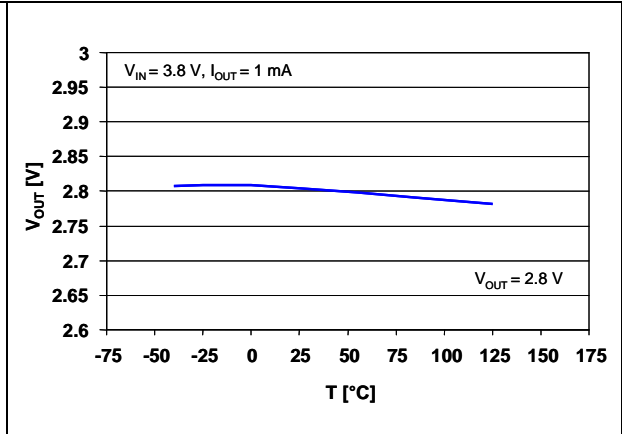

Figure 6. Line regulation vs. temperature

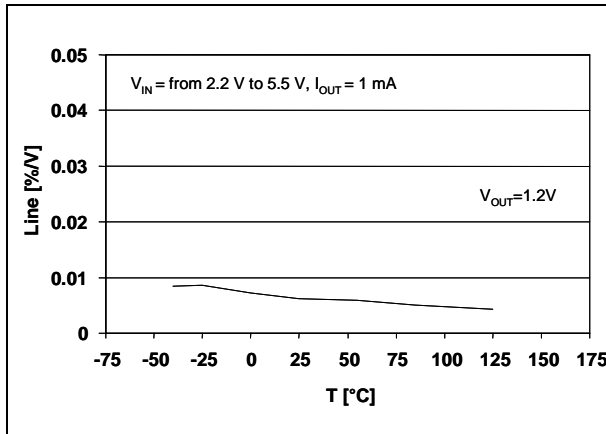

Figure 7. Load regulation vs. temperature

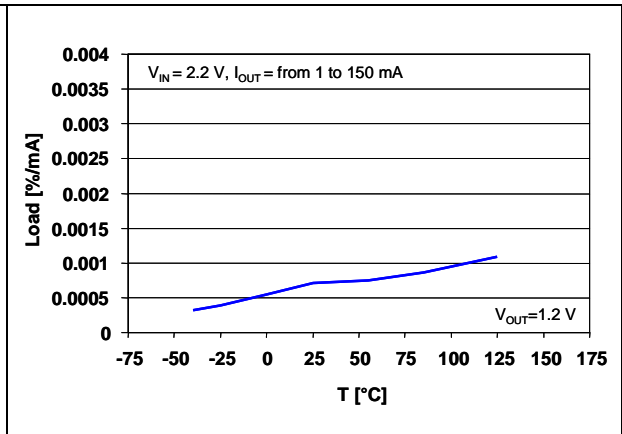

Figure 8. Short-circuit current vs. drop voltage

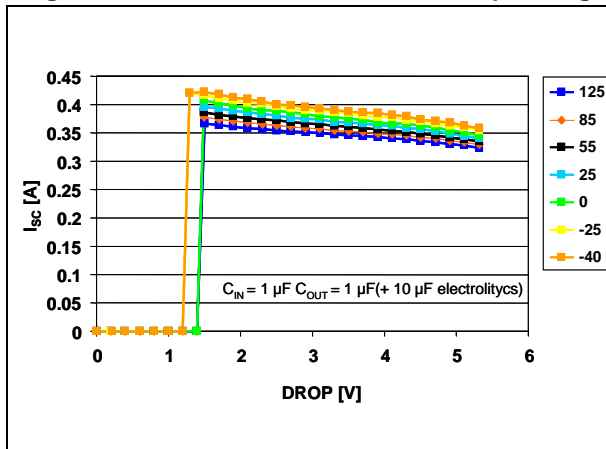

Figure 9. Dropout voltage vs. temperature

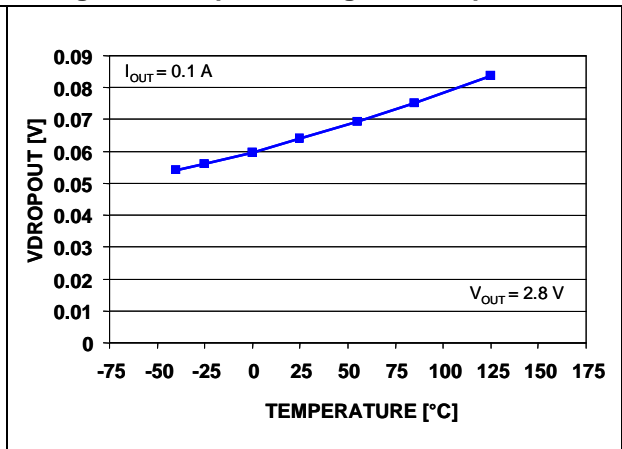

Figure 10. Dropout voltage vs. output current

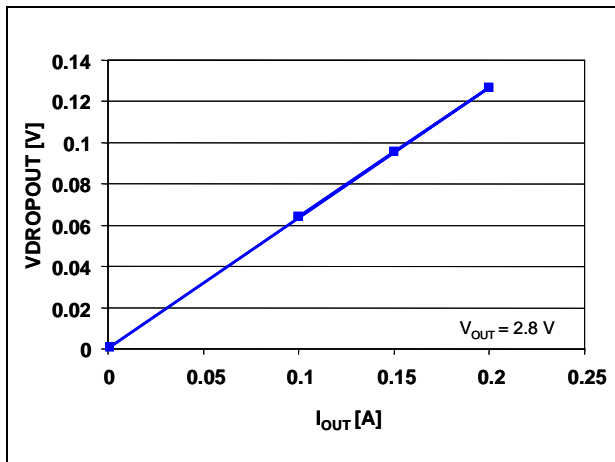

Figure 11. Output voltage vs. input voltage (V_{OUT} = 1.3 V)

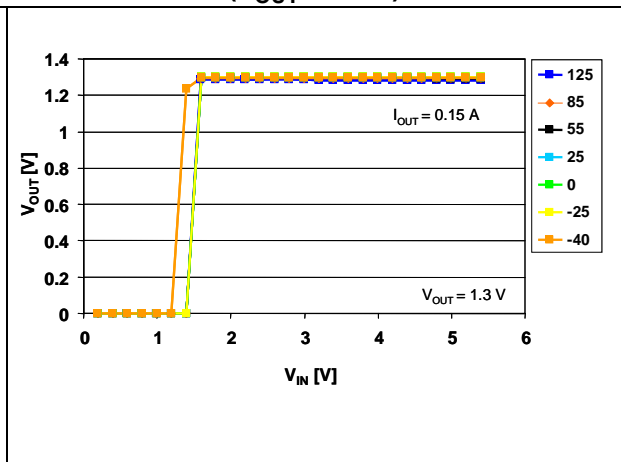

Figure 12. Output voltage vs. input voltage (V_{OUT} = 2.8 V)

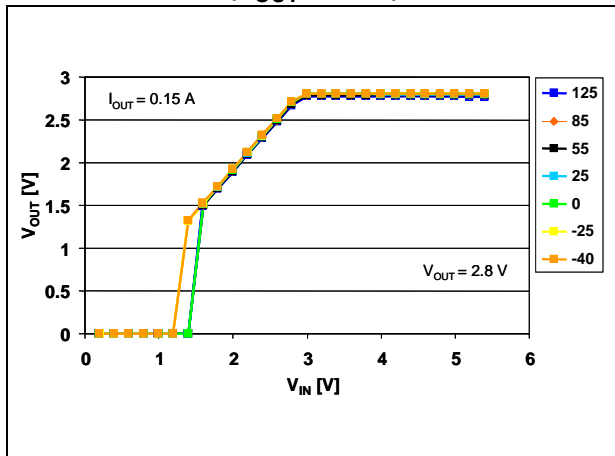

Figure 13. Enable threshold vs. temperature

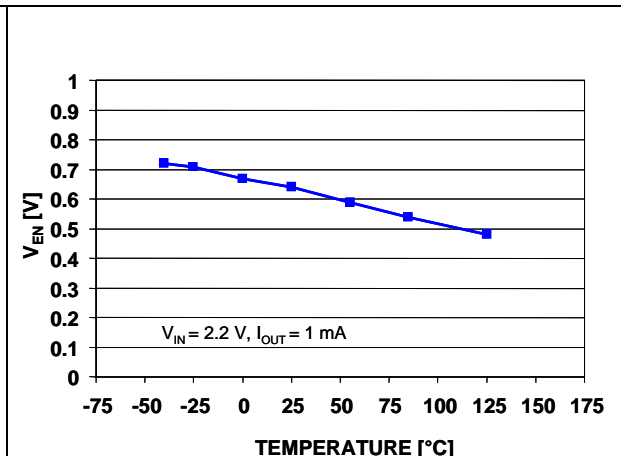

Figure 14. Quiescent current vs. temperature (V_{OUT} = 1.2 V, I_{OUT} = 0 mA)

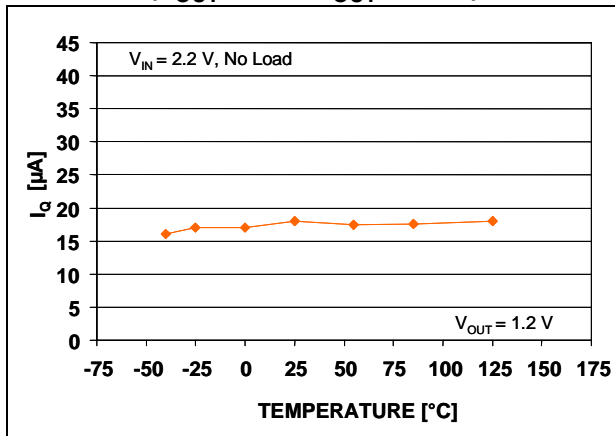

Figure 15. Quiescent current vs. temperature (V_{OUT} = 1.2 V, I_{OUT} = 0.15 A)

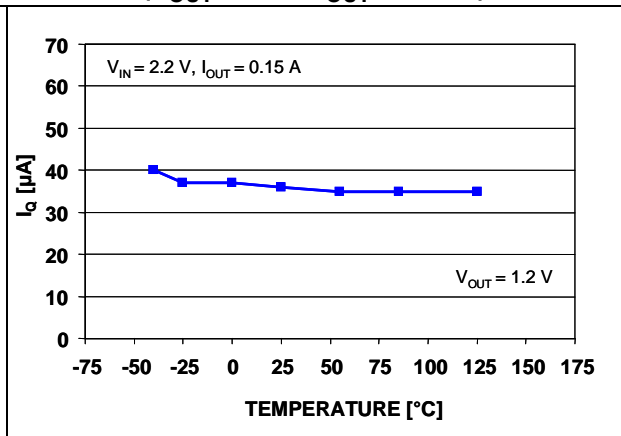

Figure 16. Quiescent current vs. temperature
($V_{OUT} = 2.8\text{ V}$, $I_{OUT} = 0.15\text{ A}$)

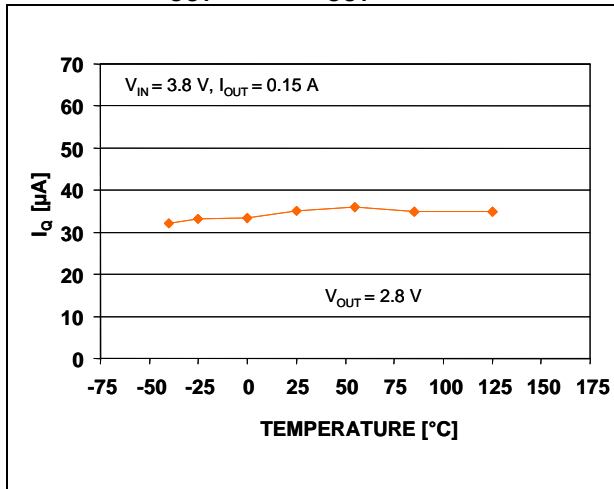

Figure 17. Quiescent current vs. input voltage

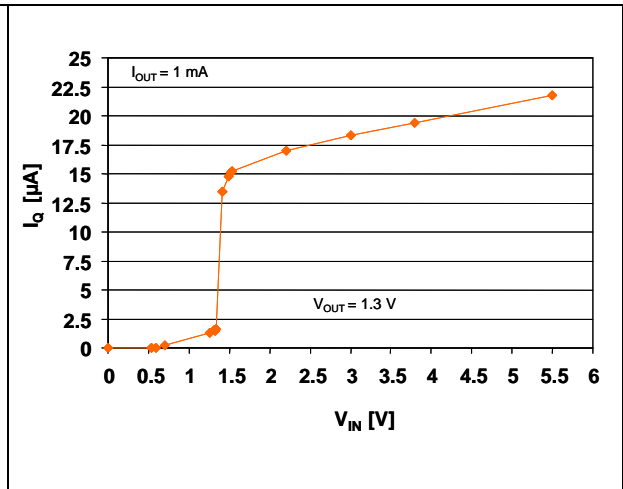

Figure 18. Quiescent current vs. output current

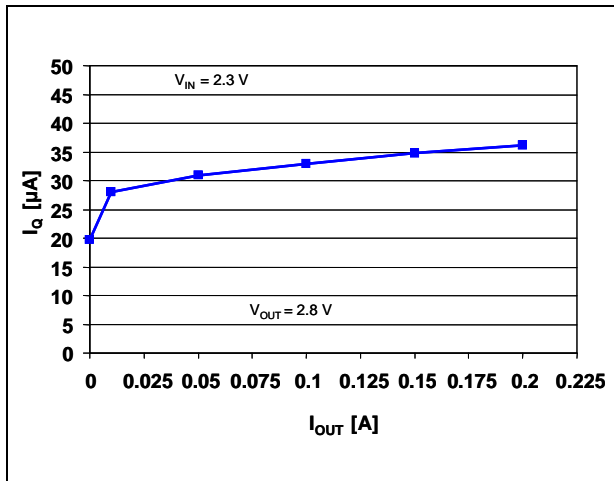

Figure 19. Supply voltage rejection vs. temperature
($V_{OUT} = 1.2\text{ V}$)

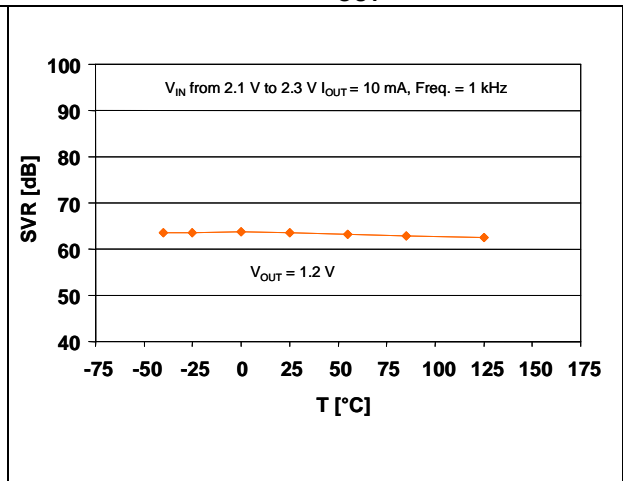

Figure 20. Supply voltage rejection vs. temperature ($V_{OUT} = 1.3\text{ V}$)

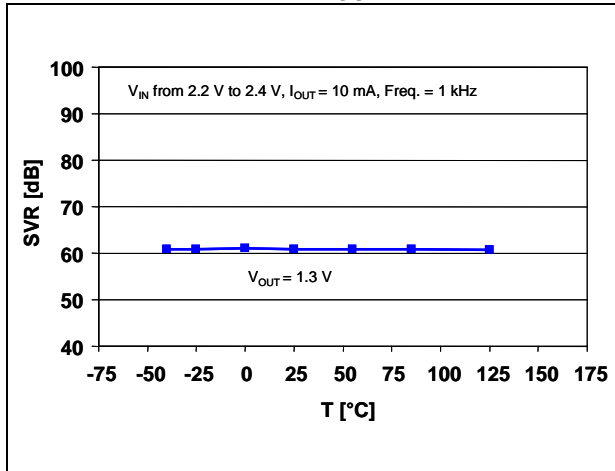

Figure 21. Supply voltage rejection vs. temperature (Freq. = 1 kHz)

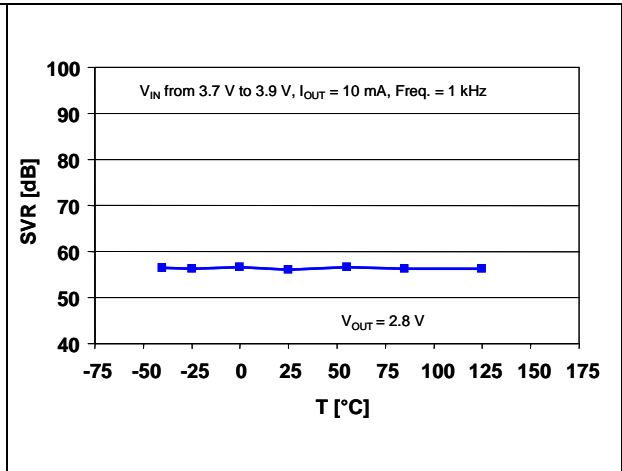

Figure 22. Supply voltage rejection vs. temperature (Freq. = 10 kHz)

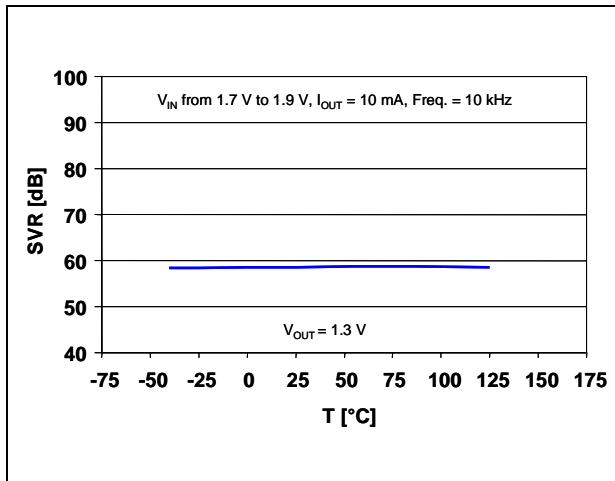

Figure 23. Supply voltage rejection vs. temperature ($V_{OUT} = 2.8\text{ V}$)

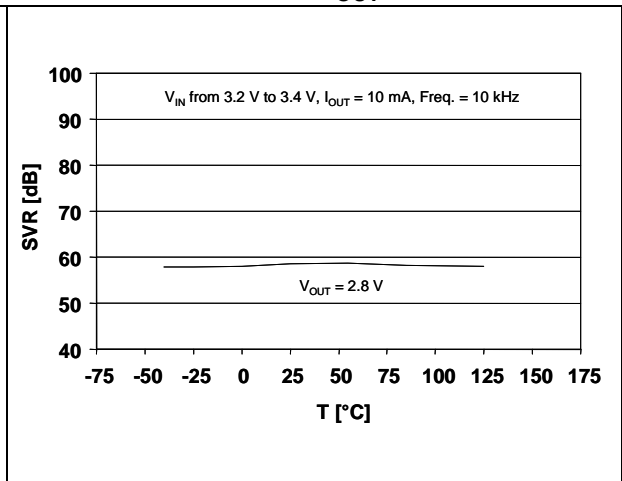

Figure 24. Supply voltage rejection vs. frequency ($V_{OUT} = 1.2\text{ V}$)

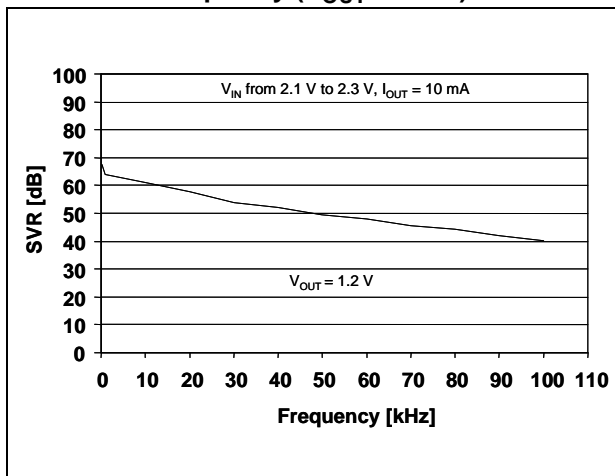

Figure 25. Supply voltage rejection vs. frequency ($V_{OUT} = 1.3\text{ V}$)

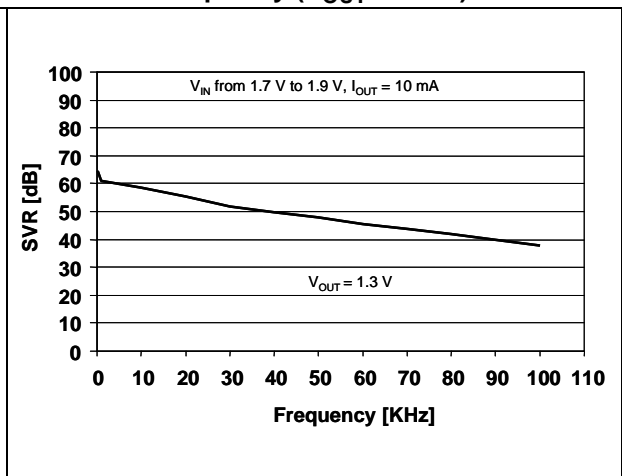

Figure 26. Supply voltage rejection vs. frequency ($V_{OUT} = 2.8\text{ V}$)

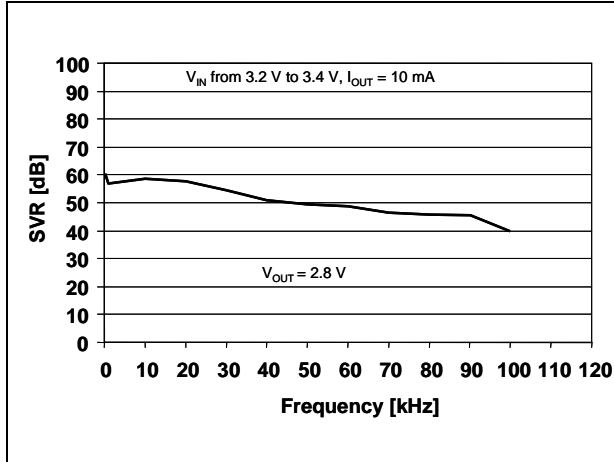

Figure 27. Supply voltage rejection vs. output current

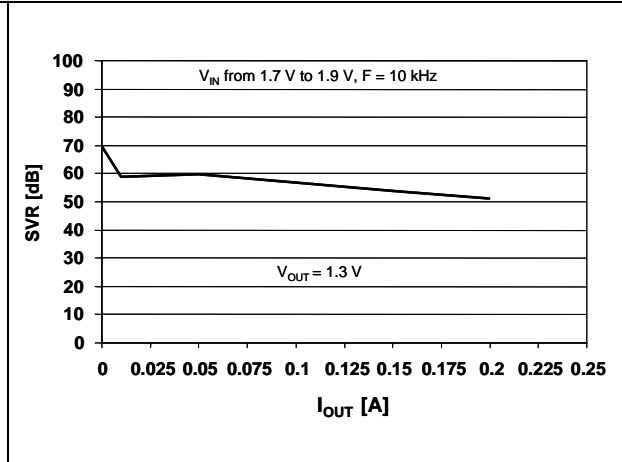

Figure 28. LD39115J noise

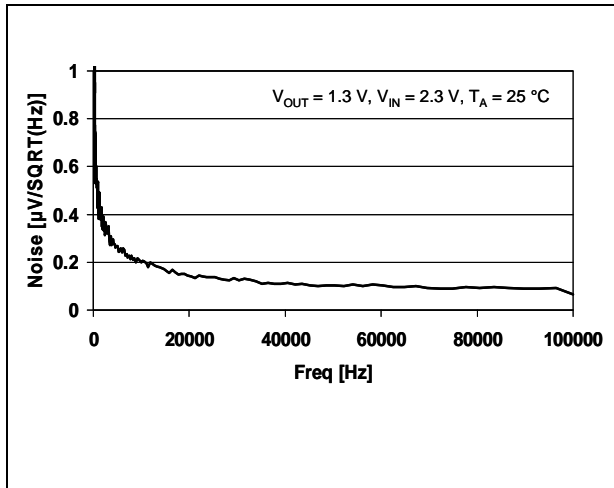

Figure 29. Line regulation transient

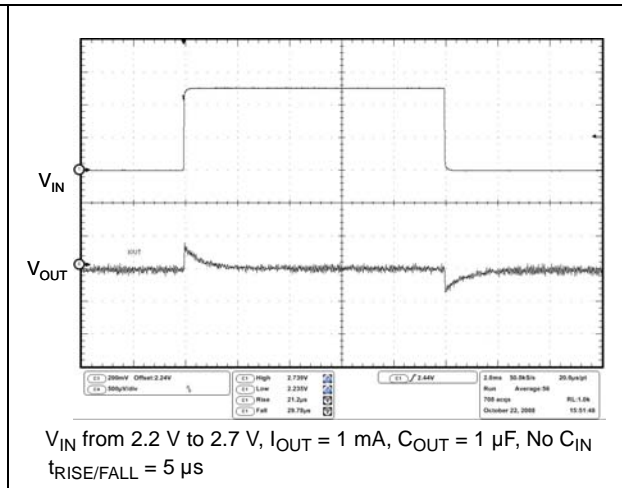

Figure 30. Start up transient

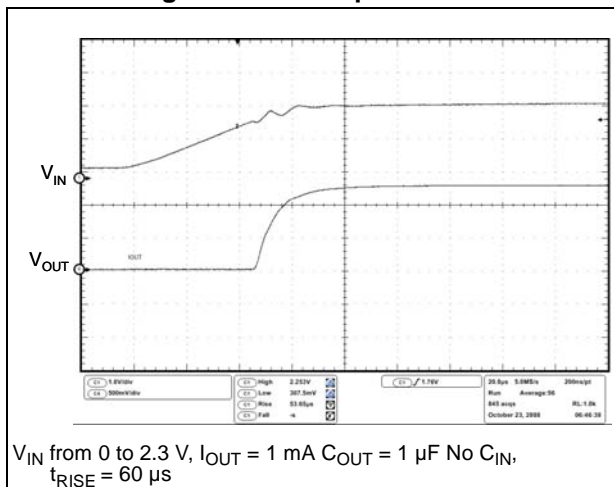

Figure 31. Enable transient ($V_{OUT} = 1.2\text{ V}$)

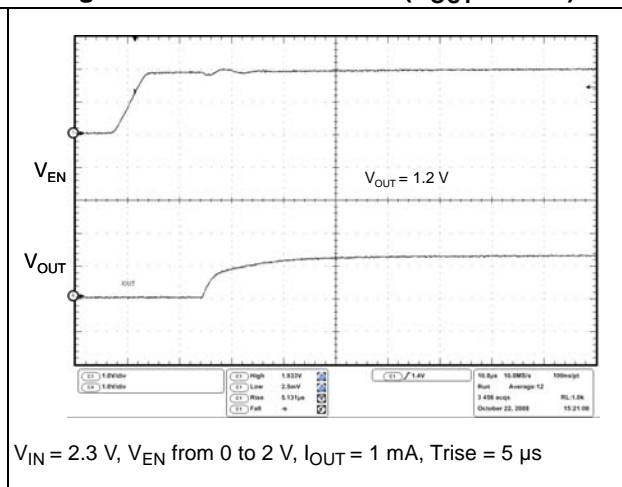

Figure 32. Enable transient ($V_{OUT} = 2.8\text{ V}$)

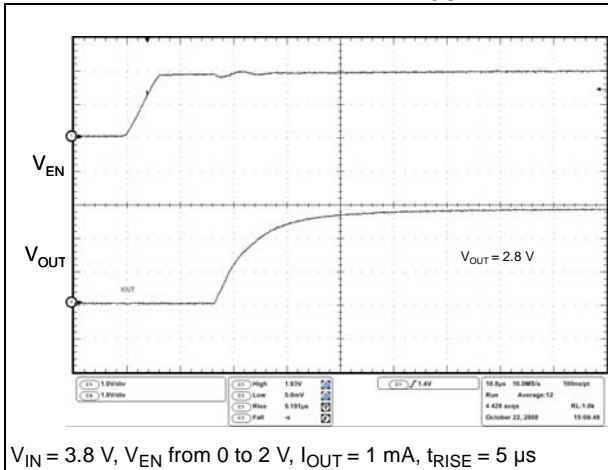

Figure 33. Load transient ($V_{OUT} = 1.2\text{ V}$)

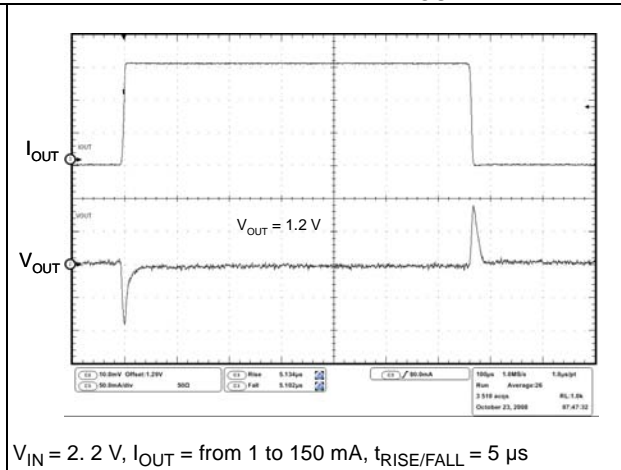

Figure 34. Load transient ($V_{OUT} = 2.8\text{ V}$)

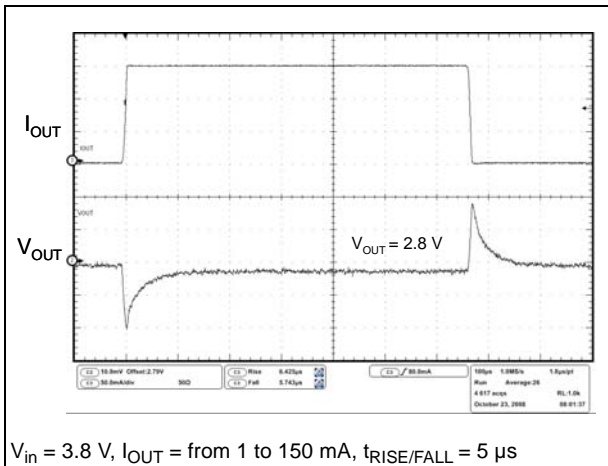
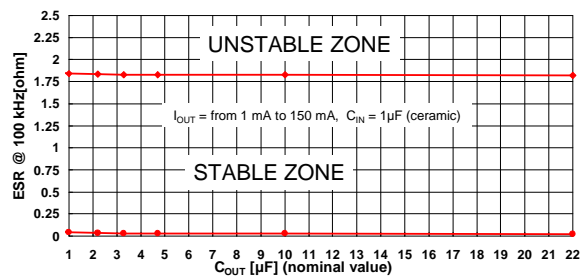

Figure 35. ESR required for stability with ceramics capacitors



7 Package mechanical data

In order to meet environmental requirements, ST offers these devices in different grades of ECOPACK® packages, depending on their level of environmental compliance. ECOPACK® specifications, grade definitions and product status are available at: www.st.com. ECOPACK® is an ST trademark.

Figure 36. Flip-chip 4 drawings

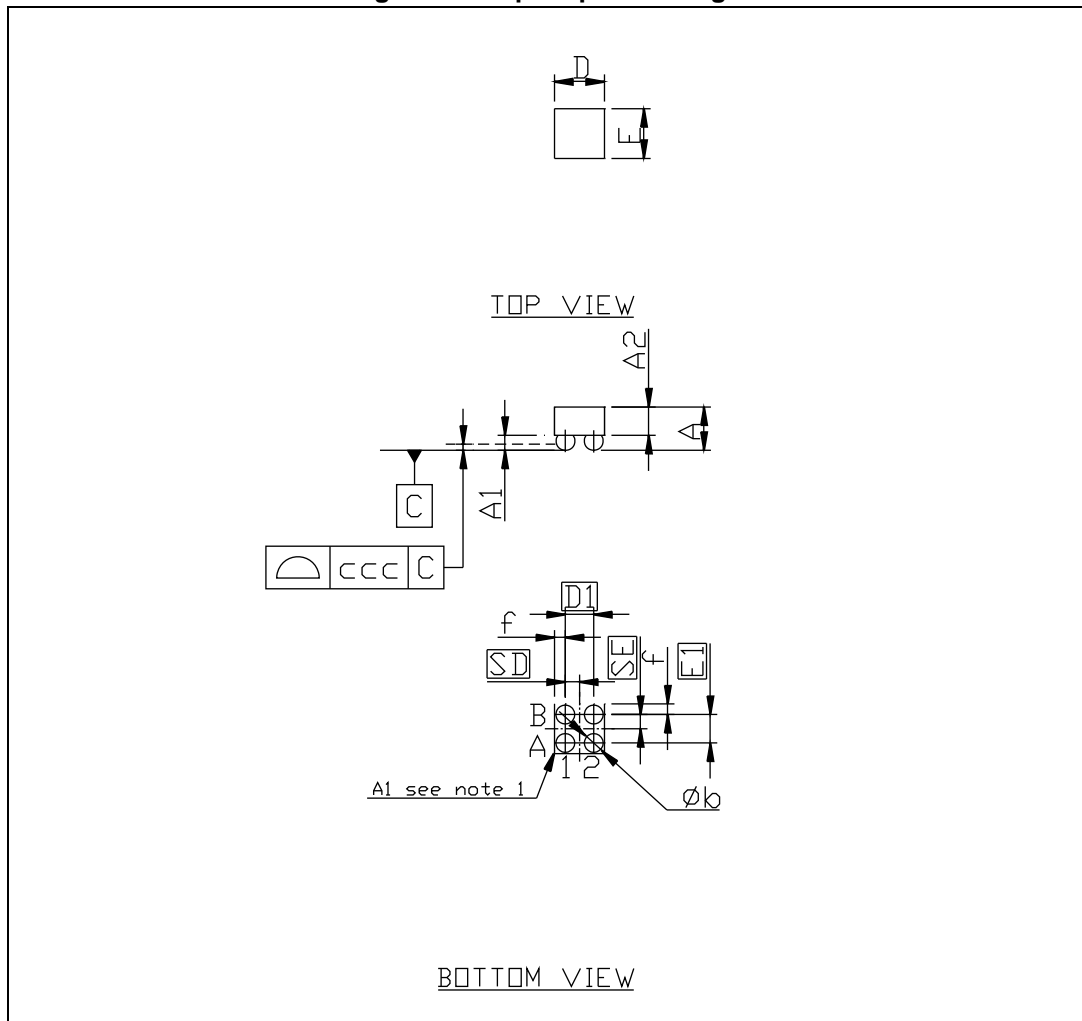
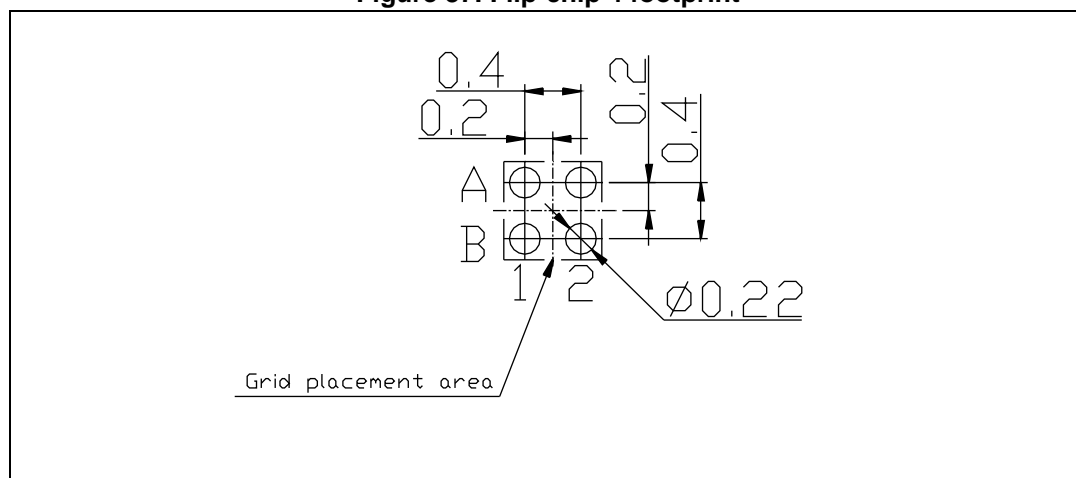

Table 6. Flip-chip 4 mechanical data

Dim.	mm		
	Min.	Typ.	Max.
A	0.52	0.56	0.60
A1	0.17	0.20	0.23
A2	0.35	0.36	0.37
b	0.23	0.25	0.29
D	0.758	0.788	0.818
D1		0.4	
E	0.758	0.788	0.818
E1		0.4	
SD	0.18	0.2	0.22
SE	0.18	0.2	0.22
f		0.199	
ccc		0.075	

Figure 37. Flip-chip 4 footprint



8 Packaging mechanical data

Figure 38. Flip-chip 4 tape and reel drawing

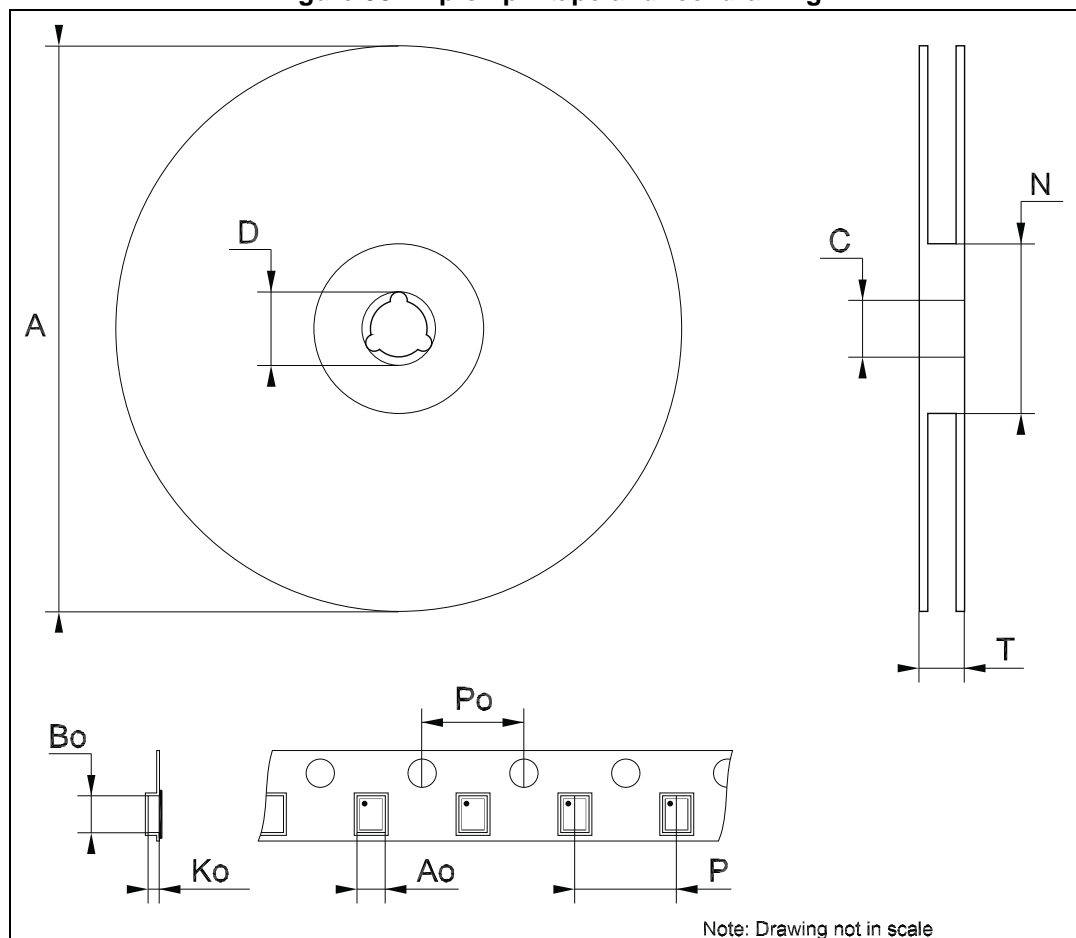

Table 7. Flip-chip 4 tape and reel mechanical data

Dim.	mm		
	Min.	Typ.	Max.
A			178
C	12.8		13.2
D	20.2		
N	59	60	61
T			8.4
Ao	0.82	0.87	0.92
Bo	0.82	0.87	0.92
Ko	0.64	0.69	0.74
Po	3.9	4.0	4.1
P	3.9	4.0	4.1

9 Different output voltage versions of the LD39115J available on request

Table 8. Options available on request

Order codes	Output voltages
LD39115J08R	0.8 V
LD39115J10R	1.0 V

10 Revision history

Table 9. Document revision history

Date	Revision	Changes
26-Mar-2009	1	Initial release.
12-Jun-2009	2	Modified: Table 1 on page 1 and Table 8 on page 19 .
05-Aug-2009	3	Modified: tape and reel mechanical data on page 18 .
17-May-2011	4	Modified: Table 1 on page 1 and Table 8 on page 19 .
20-Dec-2011	5	Added: new order code LD39115J25R Table 1 on page 1 .
16-Jan-2014	6	Part number LD39115Jxx changed to LD39115J. Updated the Description in cover page, Section 7: Package mechanical data . Added Section 8: Packaging mechanical data . Minor text changes.

Please Read Carefully:

Information in this document is provided solely in connection with ST products. STMicroelectronics NV and its subsidiaries ("ST") reserve the right to make changes, corrections, modifications or improvements, to this document, and the products and services described herein at any time, without notice.

All ST products are sold pursuant to ST's terms and conditions of sale.

Purchasers are solely responsible for the choice, selection and use of the ST products and services described herein, and ST assumes no liability whatsoever relating to the choice, selection or use of the ST products and services described herein.

No license, express or implied, by estoppel or otherwise, to any intellectual property rights is granted under this document. If any part of this document refers to any third party products or services it shall not be deemed a license grant by ST for the use of such third party products or services, or any intellectual property contained therein or considered as a warranty covering the use in any manner whatsoever of such third party products or services or any intellectual property contained therein.

UNLESS OTHERWISE SET FORTH IN ST'S TERMS AND CONDITIONS OF SALE ST DISCLAIMS ANY EXPRESS OR IMPLIED WARRANTY WITH RESPECT TO THE USE AND/OR SALE OF ST PRODUCTS INCLUDING WITHOUT LIMITATION IMPLIED WARRANTIES OF MERCHANTABILITY, FITNESS FOR A PARTICULAR PURPOSE (AND THEIR EQUIVALENTS UNDER THE LAWS OF ANY JURISDICTION), OR INFRINGEMENT OF ANY PATENT, COPYRIGHT OR OTHER INTELLECTUAL PROPERTY RIGHT.

ST PRODUCTS ARE NOT DESIGNED OR AUTHORIZED FOR USE IN: (A) SAFETY CRITICAL APPLICATIONS SUCH AS LIFE SUPPORTING, ACTIVE IMPLANTED DEVICES OR SYSTEMS WITH PRODUCT FUNCTIONAL SAFETY REQUIREMENTS; (B) AERONAUTIC APPLICATIONS; (C) AUTOMOTIVE APPLICATIONS OR ENVIRONMENTS, AND/OR (D) AEROSPACE APPLICATIONS OR ENVIRONMENTS. WHERE ST PRODUCTS ARE NOT DESIGNED FOR SUCH USE, THE PURCHASER SHALL USE PRODUCTS AT PURCHASER'S SOLE RISK, EVEN IF ST HAS BEEN INFORMED IN WRITING OF SUCH USAGE, UNLESS A PRODUCT IS EXPRESSLY DESIGNATED BY ST AS BEING INTENDED FOR "AUTOMOTIVE, AUTOMOTIVE SAFETY OR MEDICAL" INDUSTRY DOMAINS ACCORDING TO ST PRODUCT DESIGN SPECIFICATIONS. PRODUCTS FORMALLY ESCC, QML OR JAN QUALIFIED ARE DEEMED SUITABLE FOR USE IN AEROSPACE BY THE CORRESPONDING GOVERNMENTAL AGENCY.

Resale of ST products with provisions different from the statements and/or technical features set forth in this document shall immediately void any warranty granted by ST for the ST product or service described herein and shall not create or extend in any manner whatsoever, any liability of ST.

ST and the ST logo are trademarks or registered trademarks of ST in various countries.

Information in this document supersedes and replaces all information previously supplied.

The ST logo is a registered trademark of STMicroelectronics. All other names are the property of their respective owners.

© 2014 STMicroelectronics - All rights reserved

STMicroelectronics group of companies

Australia - Belgium - Brazil - Canada - China - Czech Republic - Finland - France - Germany - Hong Kong - India - Israel - Italy - Japan - Malaysia - Malta - Morocco - Philippines - Singapore - Spain - Sweden - Switzerland - United Kingdom - United States of America

www.st.com



AMEYA360

Components Supply Platform

Authorized Distribution Brand :



Website :

Welcome to visit www.ameya360.com

Contact Us :

➤ Address :

401 Building No.5, JiuGe Business Center, Lane 2301, Yishan Rd
Minhang District, Shanghai , China

➤ Sales :

Direct +86 (21) 6401-6692

Email amall@ameya360.com

QQ 800077892

Skype [ameyasales1](#) [ameyasales2](#)

➤ Customer Service :

Email service@ameya360.com

➤ Partnership :

Tel +86 (21) 64016692-8333

Email mkt@ameya360.com