

General-purpose Operational Amplifiers / Comparators

# NOW SERIES Comparators



LM393MX, LM2903MX, LM339MX, LM2901MX

No.11094ECT06

●Description

The Universal Standard family LM393 / LM339 / LM2903 / LM2901 monolithic ICs integrate two / four independent comparators on a single chip and feature high gain, low power consumption, and an operating voltage range from 2[V] to 36[V] (single power supply).

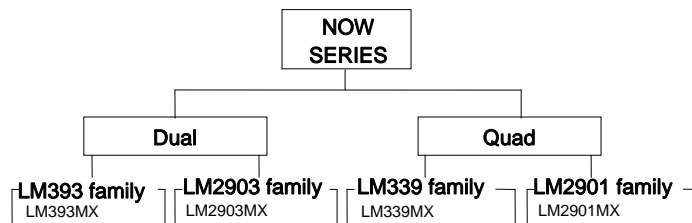

●Features

- 1) Operating temperature range Commercial Grade  
LM339/393 family: 0[°C] to +70[°C]  
Extended Industrial Grade  
LM2903/2901 family: -40[°C] to +85[°C]
- 2) Open collector output
- 3) Single / dual power supply compatible
- 4) Low supply current  
0.8[mA] typ.(LM2901/339 family)  
0.4[mA] typ.(LM2903/393 family)
- 5) Low input-bias current: 25[nA] typ.
- 6) Low input-offset current: 5[nA] typ.
- 7) Input common-mode voltage range, including ground
- 8) Differential input voltage range equal to maximum rated supply voltage
- 9) Low output saturation voltage
- 10) TTL,MOS,CMOS compatible output

●Pin Assignment

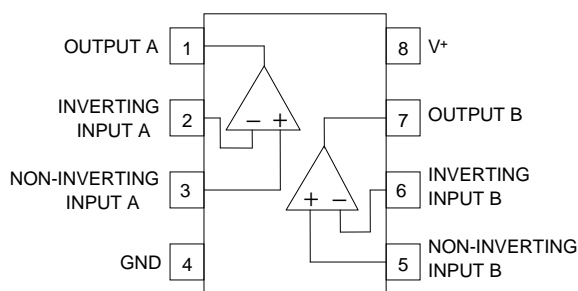

**S.O package8**

LM393MX  
LM2903MX

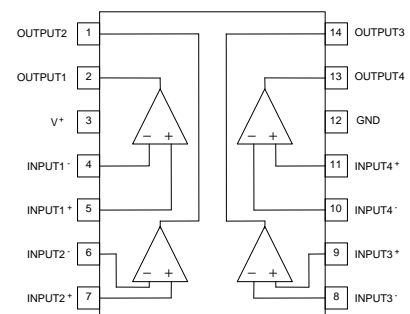

**S.O package14**

LM339MX  
LM2901MX

●Absolute Maximum Ratings (Ta=25°C)

Parameter	Symbol	Rating				Unit
		LM393 family	LM339 family	LM2903 family	LM2901 family	
Supply Voltage	V <sup>+</sup> -GND	+36				V
Input Differential Voltage	V <sub>id</sub>	±36				V
Common-mode Input Voltage	V <sub>icm</sub>	-0.3 to +36				V
Operating Temperature Range	T <sub>opr</sub>	0 to +70		-40 to +85		°C
Storage Temperature Range	T <sub>stg</sub>	-65 to +150				°C
Maximum Junction Temperature	T <sub>jmax</sub>	+150				°C

●Electric Characteristics

OLM393/339 Family(Unless otherwise specified, V<sup>+</sup>=+5[V])

Parameter	Symbol	Temperature range	Limits						Unit	Condition	Fig.No
			LM393 family			LM339 family					
			Min.	Typ.	Max.	Min.	Typ.	Max.			
Input Offset Voltage (*1)	V <sub>IO</sub>	25°C	—	1	7	—	2	7	mV	V <sup>+</sup> =5 to 30[V],VO=1.4[V], RS=0[Ω] VCM=0[V] to V <sup>+</sup> -1.5[V]	88
		Full range	—	—	9	—	—	15			
Input Bias Voltage (*1)	I <sub>IB</sub>	25°C	—	25	250	—	25	250	nA	IIN(+) or IIN(-) VCM=0[V]	88
		Full range	—	—	400	—	—	400			
Input Offset Current (*1)	I <sub>IO</sub>	25°C	—	5	50	—	5	50	nA	IIN(+)-IIN(-),VCM=0[V]	88
		Full range	—	—	150	—	—	150			
Input Common-mode Voltage Range	VICR	25°C	0	—	V <sup>+</sup> -1.5	—	—	V <sup>+</sup> -1.5	V	V <sup>+</sup> =30[V]	88
		Full range	0	—	V <sup>+</sup> -2.0	—	—	V <sup>+</sup> -2.0			
Supply Current	ICC	25°C	—	0.4	1	—	0.8	2.0	mA	RL=∞,V <sup>+</sup> =5[V]	89
			—	1	2.5	—	1.0	2.5		RL=∞,V <sup>+</sup> =36[V]	
Large Signal Voltage Gain	AVD	25°C	25	200	—	25	100	—	V/mV	V <sup>+</sup> =15[V],VO=1[V] to 11[V] RL ≥ 15[kΩ]	88
Large Signal Response Time	t <sub>REL</sub>	25°C	—	300	—	—	300	—	ns	VIN=TTL logic swing, Vref=1.4[V] VRL=5[V],RL=5.1[kΩ]	89
Response Time	t <sub>RE</sub>	25°C	1.5	—	—	—	1.3	—	μs	VRL=5[V],RL=5.1[kΩ] VIN=100[mVp-p] overdrive=5[mV]	89
Output Sink Current	I <sub>SINK</sub>	25°C	6	16	—	6	16	—	mA	VIN(-)=1[V],VIN(+)=0[V] VO ≤ 1.5[V]	89
Output Saturation Voltage	VOL	25°C	—	250	400	—	250	400	mV	VIN(-)=1[V],VIN(+)=0[V] I <sub>SINK</sub> ≤ 4[mA]	89
		Full range	—	—	700	—	—	700			
Output Leakage Current	I <sub>OH</sub>	25°C	—	0.1	—	—	0.1	—	nA	VIN(-)=0[V],VIN(+)=1[V], VO=5[V]	89
		Full range	—	—	—	—	—	1.0	μA		
Differential Input Voltage	V <sub>ID</sub>	Full range	—	—	36	—	—	36	V	ALL VIN ≥ 0[V]	—

(\*1) Absolute value

OLM2903/2901 family(Unless otherwise specified,  $V_{+}=+5[V]$ )

Parameter	Symbol	Temperature range	Limit						Unit	Condition	Fig.No.
			LM2903 family			LM2901 family					
			Min.	Typ.	Max.	Min.	Typ.	Max.			
Input Offset Voltage (*2)	VIO	25°C	—	2	7	—	2	7	mV	$V^{+}=30[V]$ , $V_{O}=1.4[V]$ , $R_{S}=0[\Omega]$ $V_{CM}=0[V]$ to $V^{+}-1.5[V]$	88
		Full range	—	9	15	—	9	15			
Input Bias Current (*2)	IIB	25°C	—	25	250	—	25	250	nA	IIN(+) or IIN(-) $V_{CM}=0[V]$	88
		Full range	—	200	500	—	200	500			
Input Offset Current (*2)	IIO	25°C	—	5	50	—	5	50	nA	IIN(+)-IIN(-), $V_{CM}=0[V]$	88
		Full range	—	50	200	—	50	200			
Input Common-mode Voltage Range	VICR	25°C	—	—	$V^{+}-1.5$	—	—	$V^{+}-1.5$	V	$V^{+}=30[V]$	88
		Full range	—	—	$V^{+}-2.0$	—	—	$V^{+}-2.0$			
Supply Current	ICC	25°C	—	0.4	1	—	0.8	2	mA	$R_{L}=\infty$ , $V^{+}=5[V]$	89
			—	1	2.5	—	1	2.5			
Voltage Gain	AVD	25°C	25	100	—	25	100	—	V/mV	$V^{+}=15[V]$ , $V_{O}=1[V]$ to 11[V], $R_{L}\geq 15[k\Omega]$	88
Large Signal Response Time	tREL	25°C	—	300	—	—	300	—	ns	$V_{IN}=\text{TTL logic swing}$ , $V_{ref}=1.4[V]$ $V_{RL}=5[V]$ , $R_{L}=5.1[k\Omega]$	89
Response Time	tRE	25°C	—	1.5	—	—	1.3	—	$\mu\text{s}$	$V_{RL}=5[V]$ , $R_{L}=5.1[k\Omega]$ $V_{IN}=100[\text{mVp-p}]$ , overdrive=5[mV]	89
Output Sink Current	ISINK	25°C	6	16	—	6	16	—	mA	$V_{IN(-)}=1[V]$ , $V_{IN(+)}=0[V]$ $V_{O}\leq 1.5[V]$	89
Saturation Voltage	VOL	25°C	—	250	400	—	250	400	mV	$V_{IN(-)}=1[V]$ , $V_{IN(+)}=0[V]$ $I_{SINK}\leq 4[\text{mA}]$	89
		Full range	—	400	700	—	—	700			
Output Leakage Current	Ileak	25°C	—	0.1	—	—	0.1	—	nA	$V_{IN(-)}=0[V]$ , $V_{IN(+)}=1[V]$ , $V_{O}=5[V]$	89
		Full range	—	—	1	—	—	1	$\mu\text{A}$	$V_{IN(-)}=0[V]$ , $V_{IN(+)}=1[V]$ , $V_{O}=30[V]$	
Differential Input Voltage	VID	Full range	—	—	36	—	—	36	V	ALL $V_{IN}\geq 0[V]$	—

(\*2) Absolute value

●Reference Data LM393 family

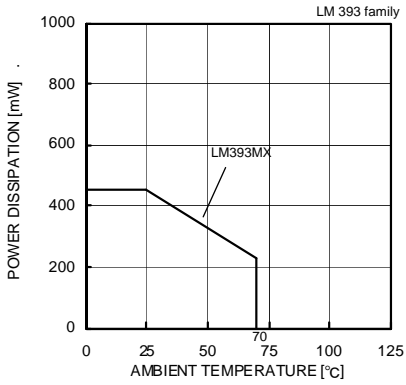

Fig. 1 Derating Curve

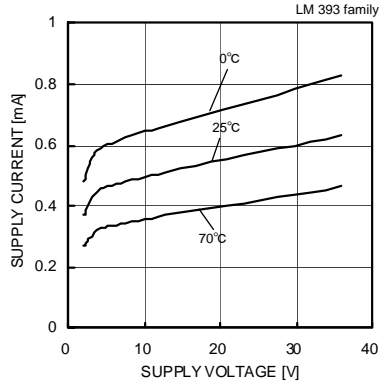

Fig. 2 Supply Current - Supply Voltage

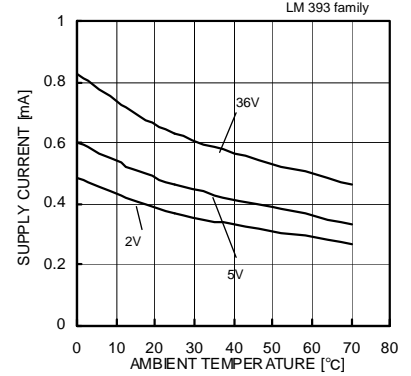

Fig. 3 Supply Current - Ambient Temperature

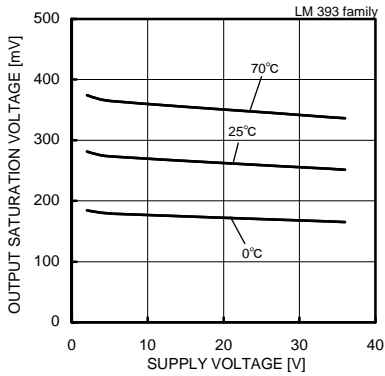

Fig. 4 Output Saturation Voltage - Supply Voltage (IOL=4[mA])

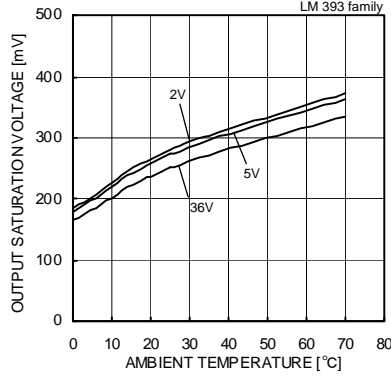

Fig. 5 Output Saturation Voltage - Ambient Temperature (IOL=4[mA])

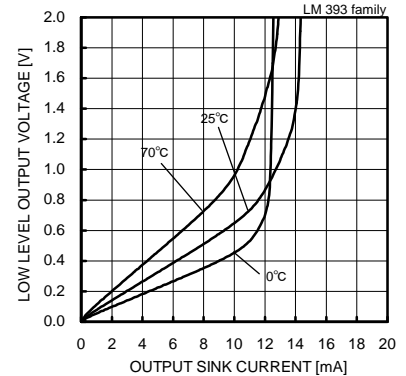

Fig. 6 Low Level Output Voltage - Output Sink Current (VCC=5[V])

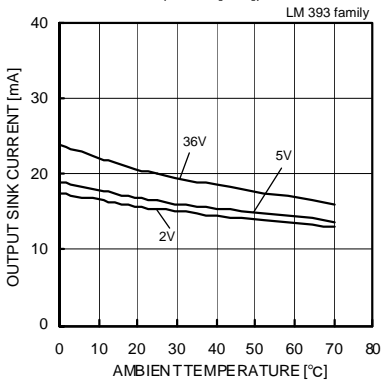

Fig. 7 Output Sink Current - Ambient Temperature (VOUT=1.5[V])

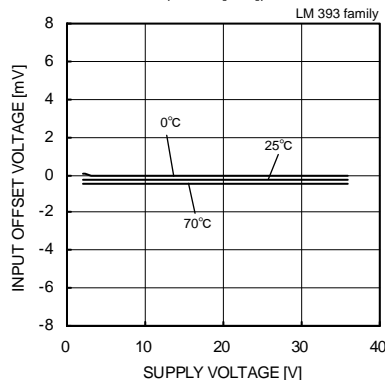

Fig. 8 Input Offset Voltage - Supply Voltage

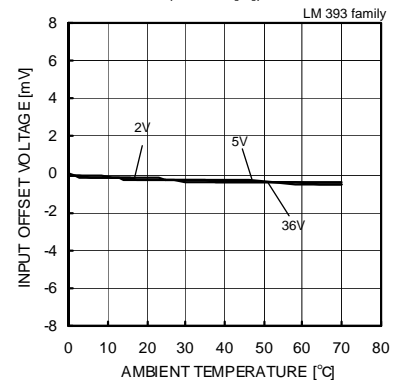

Fig. 9 Input Offset Voltage - Ambient Temperature

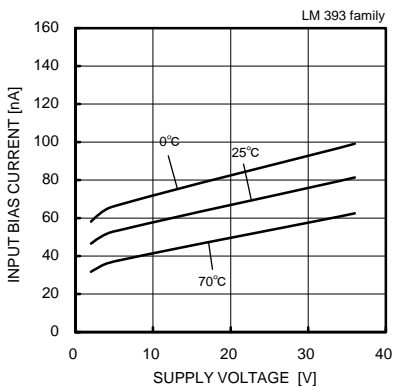

Fig. 10 Input Bias Current - Supply Voltage

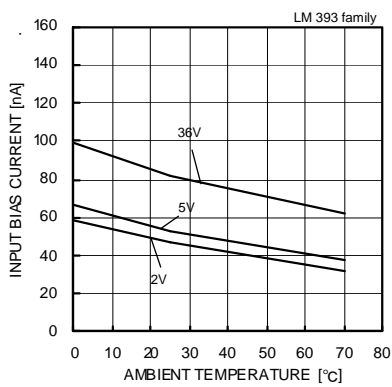

Fig. 11 Input Bias Current - Ambient Temperature

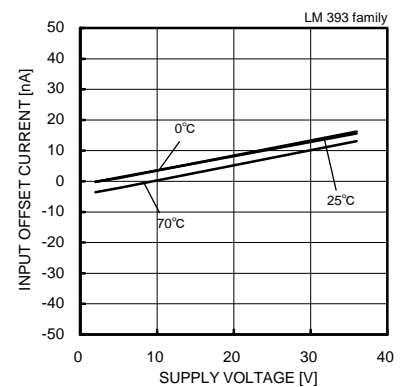

Fig. 12 Input Offset Current - Supply Voltage

(\*The data above is ability value of sample, it is not guaranteed. LM393family: 0[°C]~+70[°C]

●Reference Data LM393 family

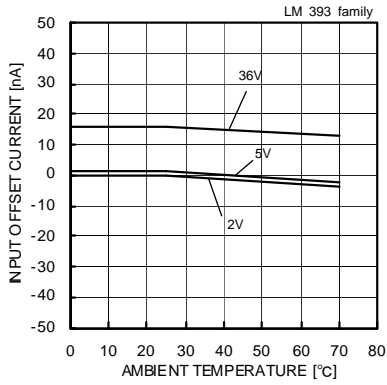

Fig. 13

Input Offset Current  
– Ambient Temperature

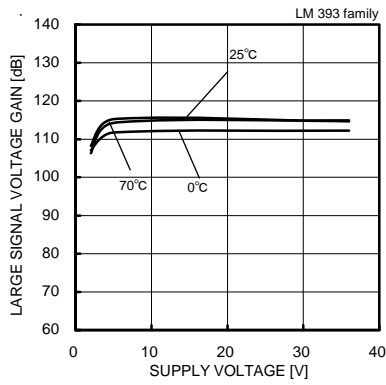

Fig. 14

Large Signal Voltage Gain  
– Supply Voltage

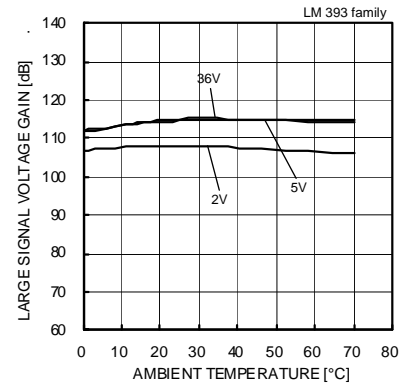

Fig. 15

Large Signal Voltage Gain  
– Ambient Temperature

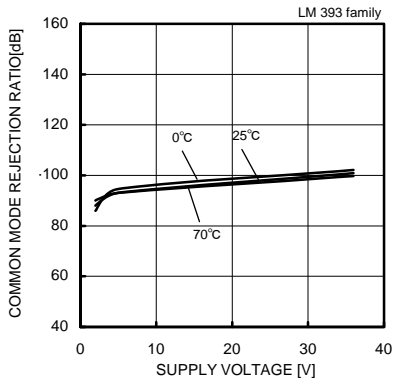

Fig. 16

Common Mode Rejection Ratio  
– Supply Voltage

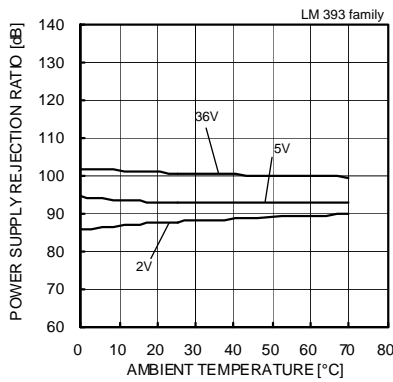

Fig. 17

Common Mode Rejection Ratio  
– Ambient Temperature

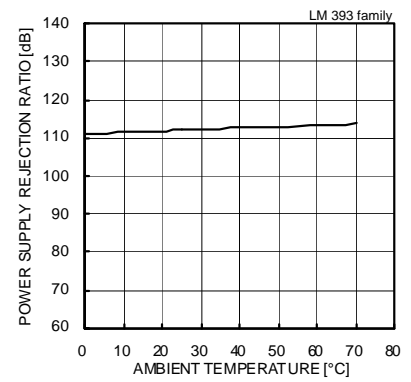

Fig. 18

Power Supply Rejection Ratio  
– Ambient Temperature

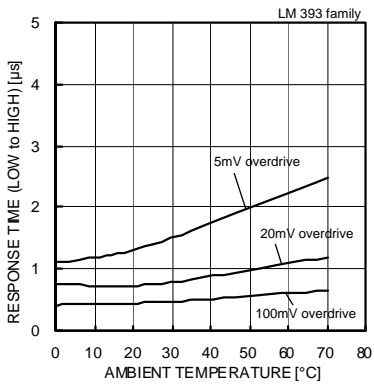

Fig. 19

Response Time (Low to High)  
– Ambient Temperature  
(VCC=5[V],VRL=5[V],RL=5.1[kΩ])

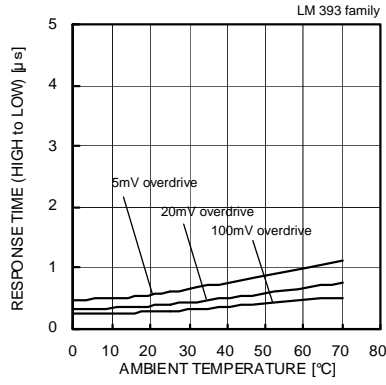

Fig. 20

Response Time (High to Low)  
– Ambient Temperature  
(VCC=5[V],VRL=5[V],RL=5.1[kΩ])

(\*)The data above is ability value of sample, it is not guaranteed. LM393family:0[°C]~+70[°C]

●Reference Data LM339 family

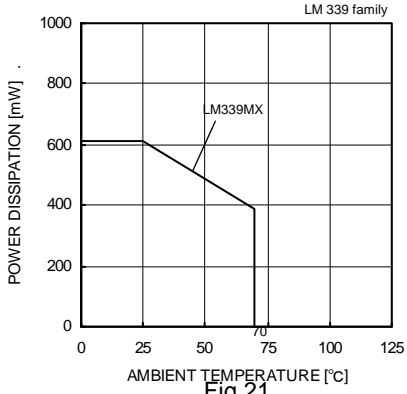

Fig. 21  
Derating Curve

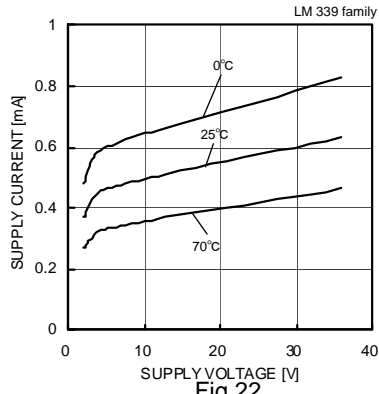

Fig. 22  
Supply Current - Supply Voltage

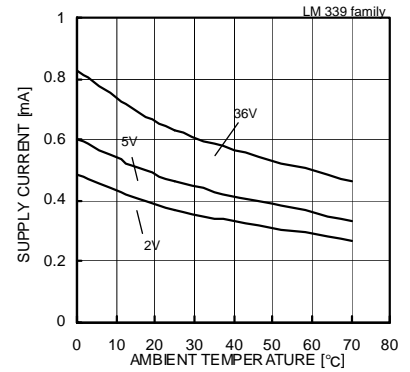

Fig. 23  
Supply Current - Ambient Temperature

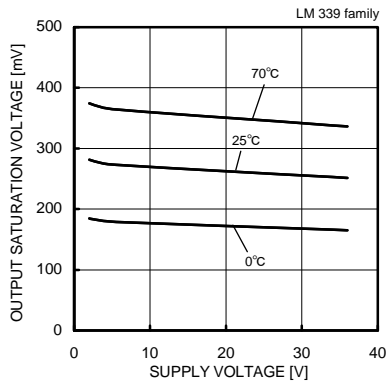

Fig. 24  
Output Saturation Voltage  
- Supply Voltage  
(IOL=4[mA])

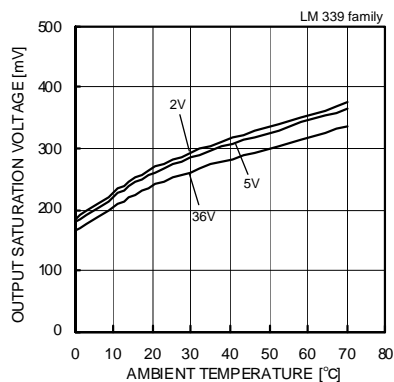

Fig. 25  
Output Saturation Voltage  
- Ambient Temperature  
(IOL=4[mA])

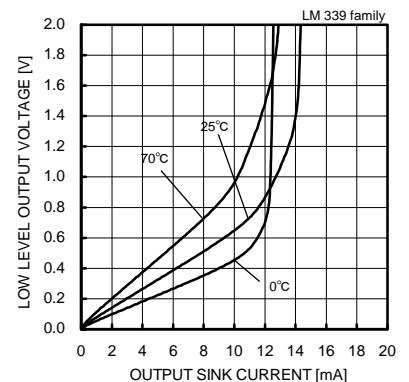

Fig. 26  
Low Level Output Voltage  
- Output Sink Current  
(VCC=5[V])

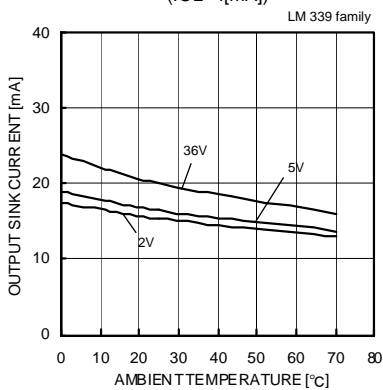

Fig. 27  
Output Sink Current - Ambient Temperature  
(VOUT=1.5[V])

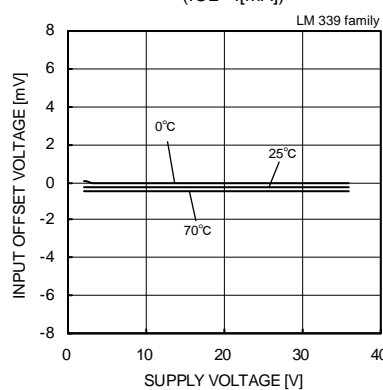

Fig. 28  
Input Offset Voltage - Supply Voltage

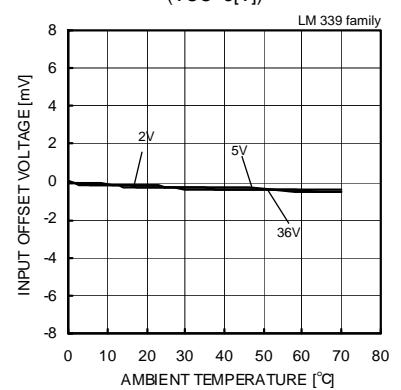

Fig. 29  
Input Offset Voltage - Ambient Temperature

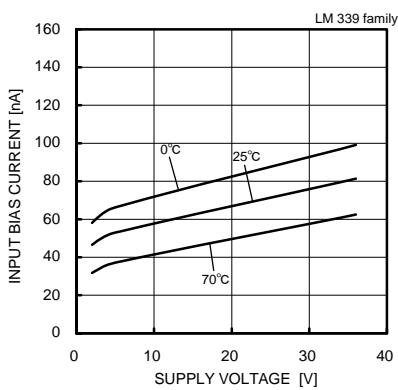

Fig. 30  
Input Bias Current - Supply Voltage

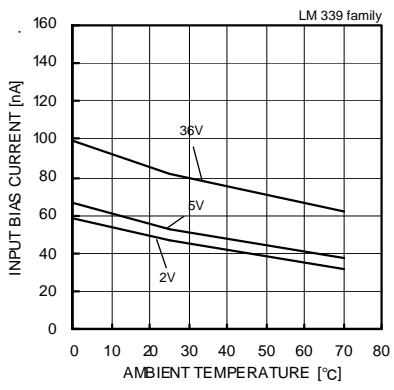

Fig. 31  
Input Bias Current - Ambient Temperature

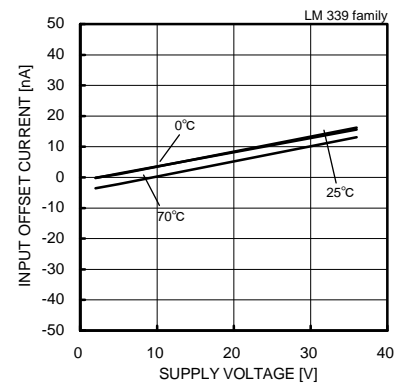
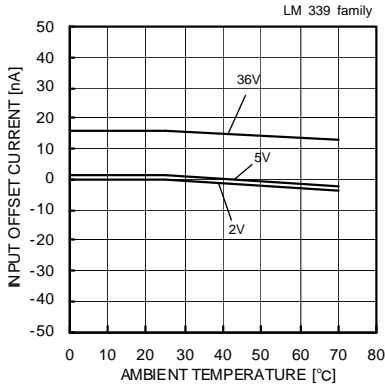

Fig. 32  
Input Offset Current - Supply Voltage

(\*)The data above is ability value of sample, it is not guaranteed. LM339family:0[°C]~+70[°C]

●Reference Data LM339 family



**Fig. 33**  
Input Offset Current  
– Ambient Temperature

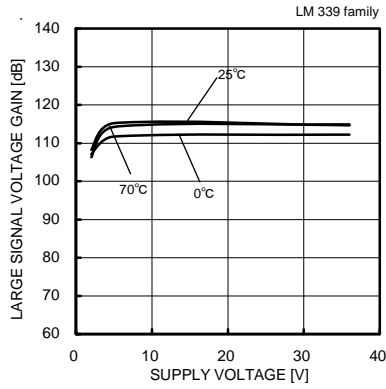

**Fig. 34**  
Large Signal Voltage Gain  
– Supply Voltage

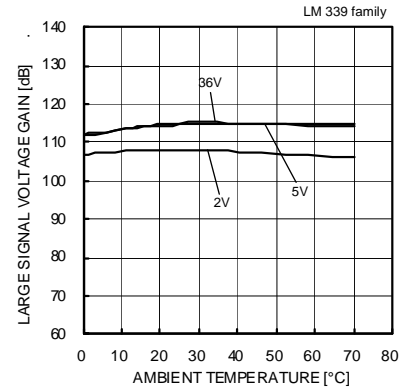

**Fig. 35**  
Large Signal Voltage Gain  
– Ambient Temperature

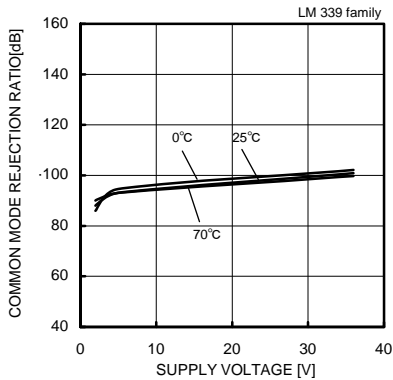

**Fig. 36**  
Common Mode Rejection Ratio  
– Supply Voltage

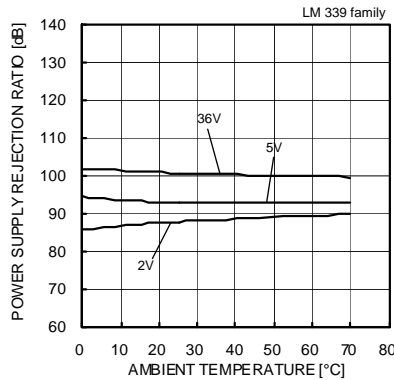

**Fig. 37**  
Common Mode Rejection Ratio  
– Ambient Temperature

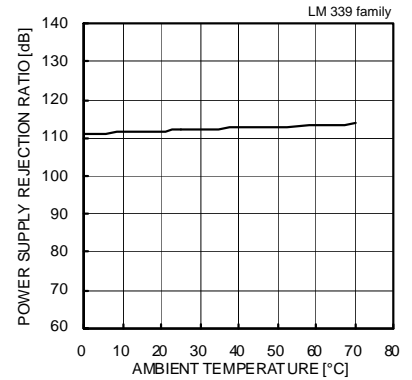

**Fig. 38**  
Power Supply Rejection Ratio  
– Ambient Temperature

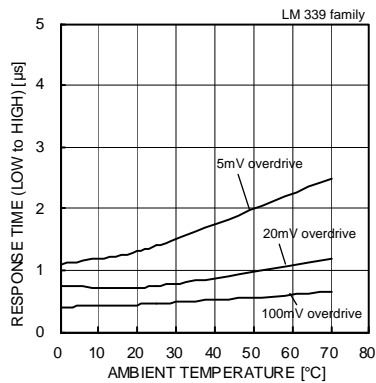

**Fig. 39**  
Response Time (Low to High)  
– Ambient Temperature  
(VCC=5[V], VRL=5[V], RL=5.1[kΩ])

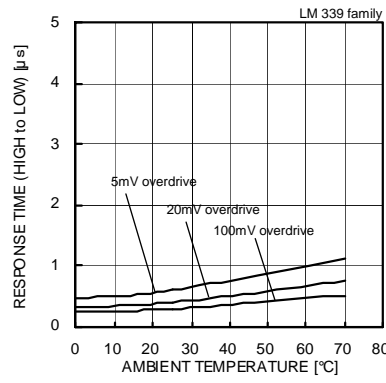

**Fig. 40**  
Response Time (High to Low)  
– Ambient Temperature  
(VCC=5[V], VRL=5[V], RL=5.1[kΩ])

(\*)The data above is ability value of sample, it is not guaranteed. LM339family:0[°C]~+70[°C]

●Reference Data LM2903 family

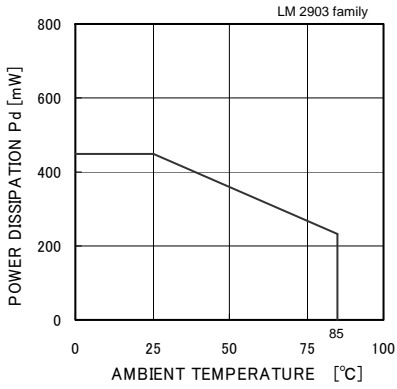

Fig. 41  
Derating Curve

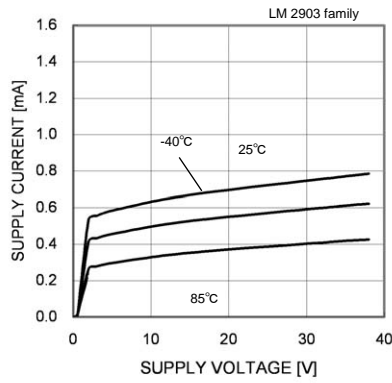

Fig. 42  
Supply Current - Supply Voltage

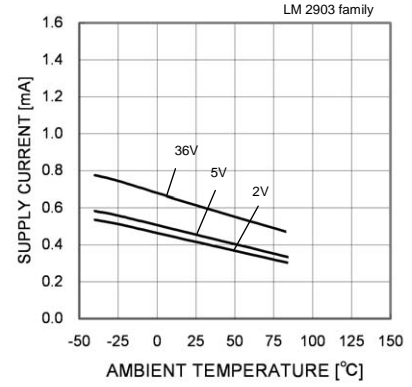

Fig. 43  
Supply Current - Ambient Temperature

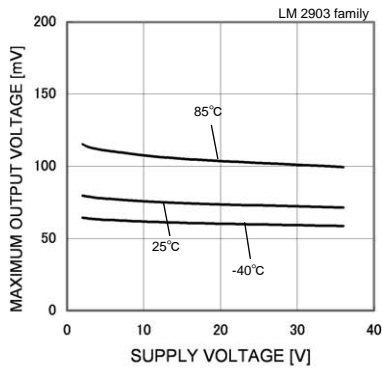

Fig. 44  
Output Saturation Voltage  
- Supply Voltage  
(IOL=4[mA])

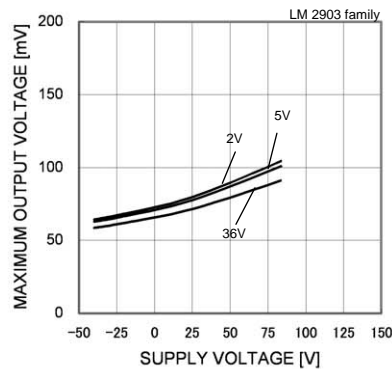

Fig. 45  
Output Saturation Voltage  
- Ambient Temperature  
(IOL=4[mA])

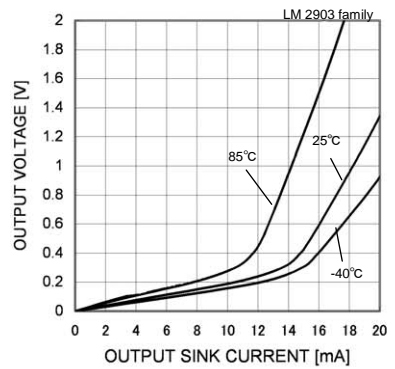

Fig. 46  
Low Level Output Voltage  
- Output Sink Current  
(VCC=5[V])

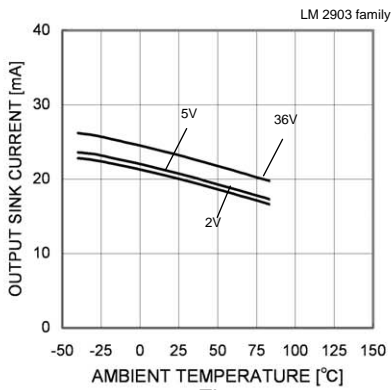

Fig. 47  
Output Sink Current - Ambient  
Temperature  
(VOUT=1.5[V])

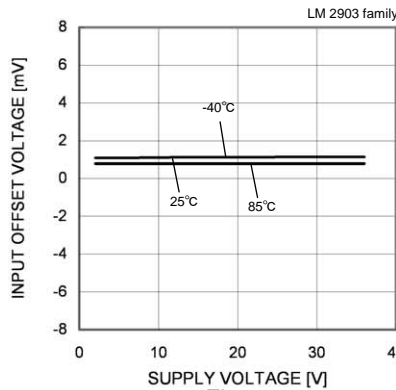

Fig. 48  
Input Offset Voltage - Supply Voltage

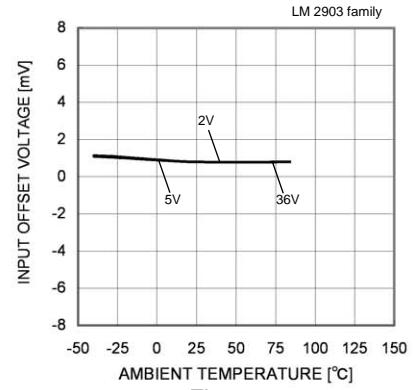

Fig. 49  
Input Offset Voltage - Ambient Temperature

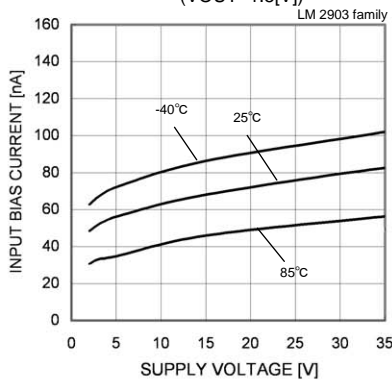

Fig. 50  
Input Bias Current - Supply Voltage

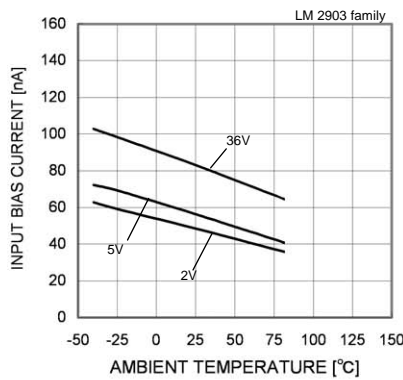

Fig. 51  
Input Bias Current - Ambient Temperature

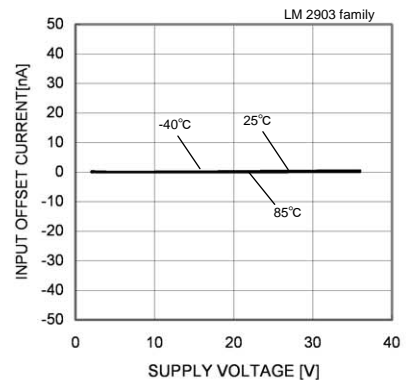

Fig. 52  
Input Offset Current - Supply Voltage

(\*)The data above is ability value of sample, it is not guaranteed.LM2903family:-40[°C]~+85[°C]



●Reference Data LM2903 family

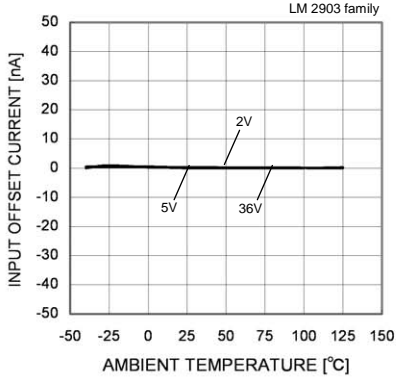

Fig. 53  
Input Offset Current – Ambient Temperature

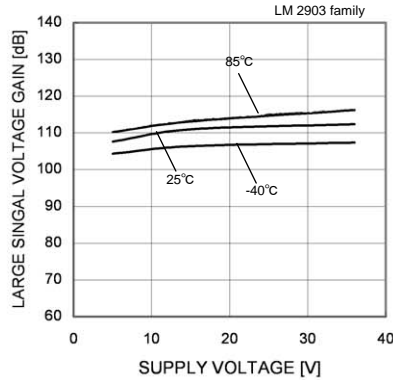

Fig. 54  
Large Signal Voltage Gain – Supply Voltage

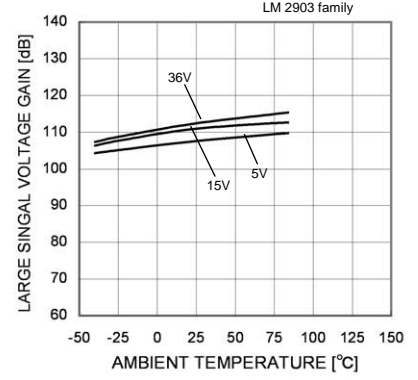

Fig. 55  
Large Signal Voltage Gain – Ambient Temperature

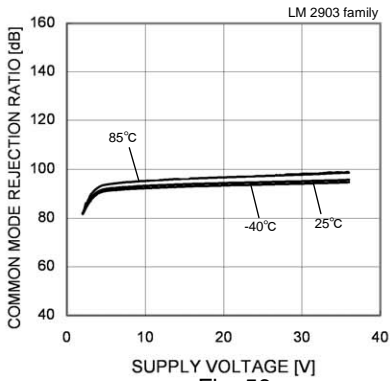

Fig. 56  
Common Mode Rejection Ratio – Supply Voltage

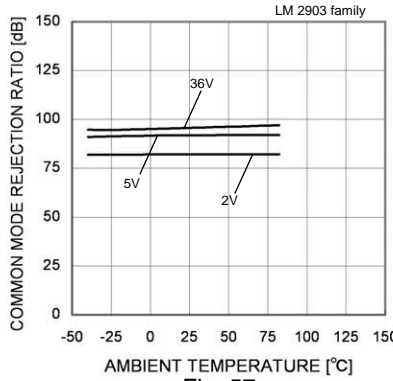

Fig. 57  
Common Mode Rejection Ratio – Ambient Temperature

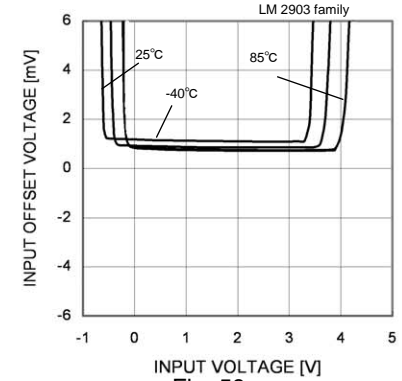

Fig. 58  
Input Offset Voltage – Input Voltage (VCC=5V)

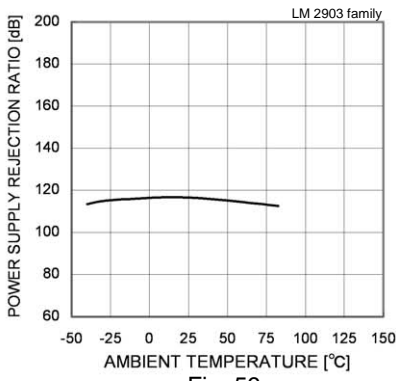

Fig. 59  
Power Supply Rejection Ratio – Ambient Temperature

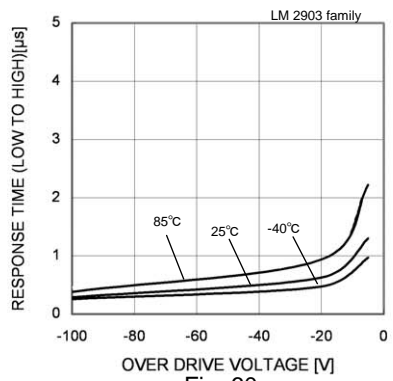

Fig. 60  
Response Time (Low to High) – Over Drive Voltage (VCC=5[V],VRL=5[V],RL=5.1[kΩ])

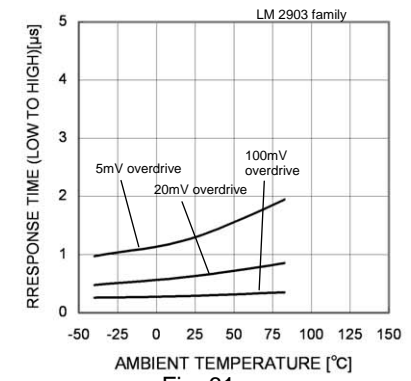

Fig. 61  
Response Time (Low to High) – Ambient Temperature (VCC=5[V],VRL=5[V],RL=5.1[kΩ])

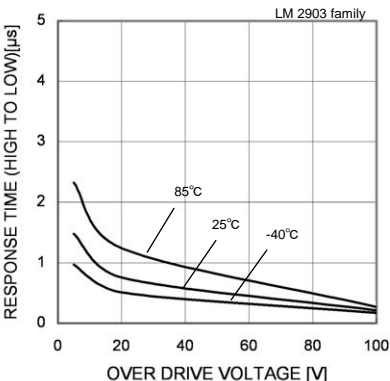

Fig. 62  
Response Time (High to Low) – Over Drive Voltage

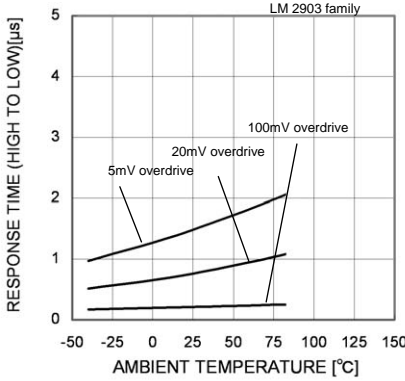

Fig. 63  
Response Time (High to Low) – Ambient Temperature

(\*)The data above is ability value of sample, it is not guaranteed. LM2903family:-40[°C]~+85[°C]

●Reference Data LM2901 family

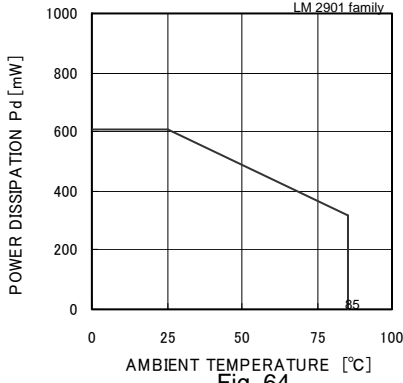

Fig. 64  
Derating Curve

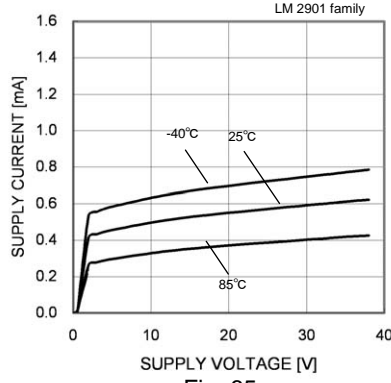

Fig. 65  
Supply Current - Supply Voltage

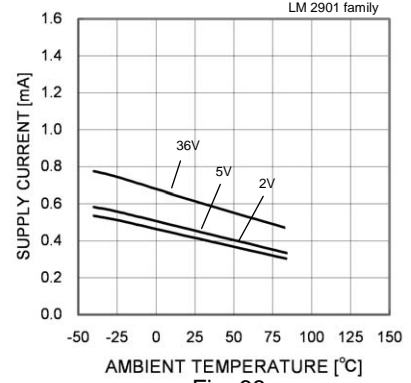

Fig. 66  
Supply Current - Ambient Temperature

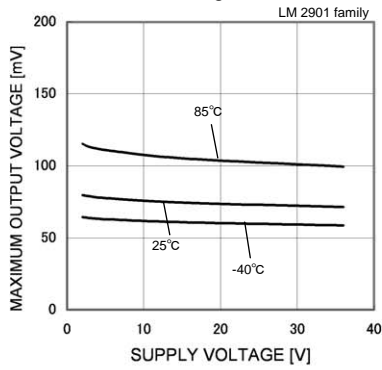

Fig. 67  
Output Saturation Voltage  
- Supply Voltage  
(IOL=4[mA])

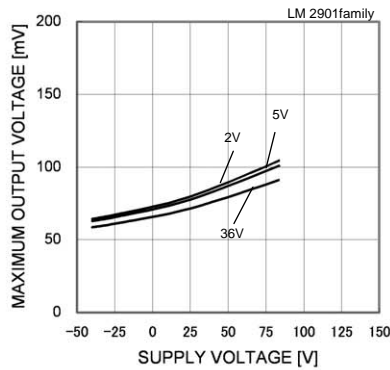

Fig. 68  
Output Saturation Voltage  
- Ambient Temperature  
(IOL=4[mA])

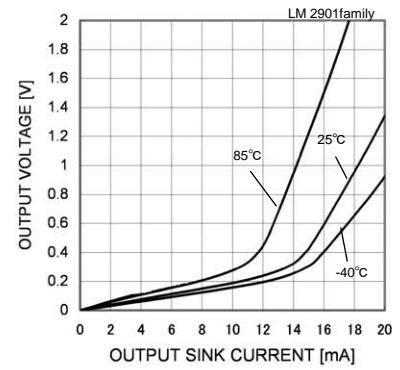

Fig. 69  
Low Level Output Voltage  
- Output Sink Current  
(VCC=5[V])

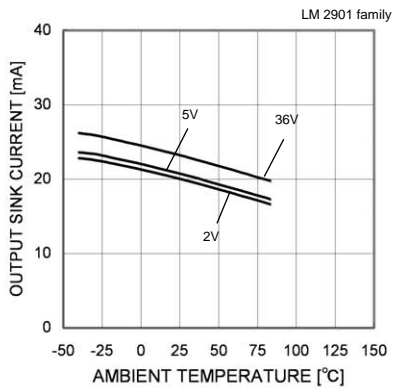

Fig. 70  
Output Sink Current - Ambient  
Temperature  
(VOUT=1.5[V])

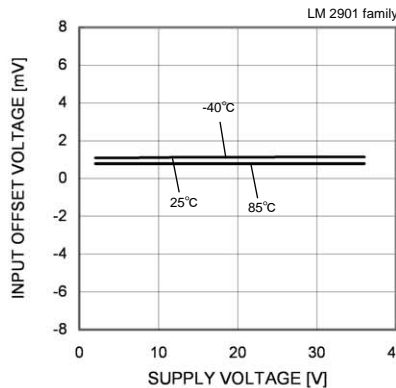

Fig. 71  
Input Offset Voltage - Supply Voltage

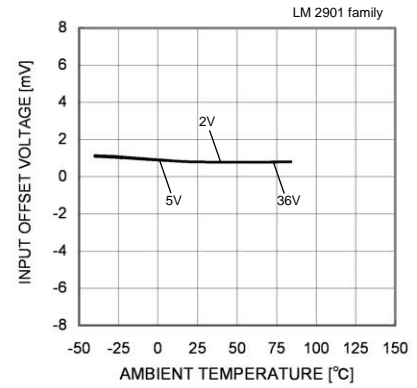

Fig. 72  
Input Offset Voltage - Ambient Temperature

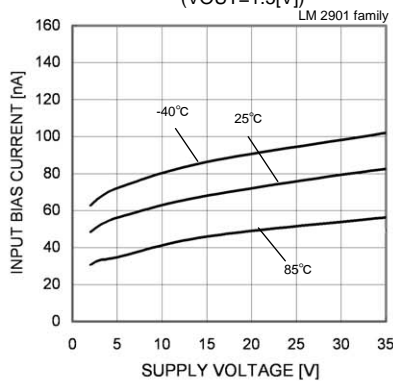

Fig. 73  
Input Bias Current - Supply Voltage

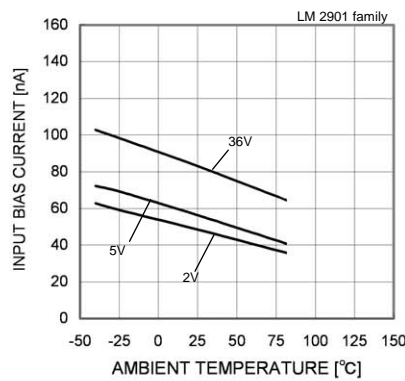

Fig. 74  
Input Bias Current - Ambient Temperature

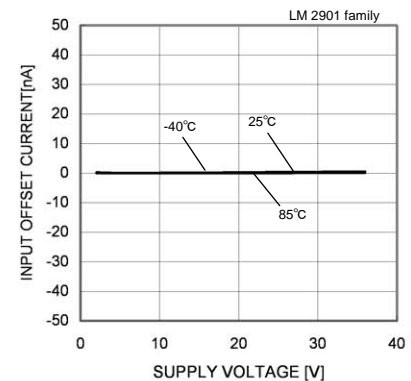

Fig. 75  
Input Offset Current - Supply Voltage

(\*)The data above is ability value of sample, it is not guaranteed.LM2903family:-40[°C]~+85[°C]

●Reference Data LM2901 family

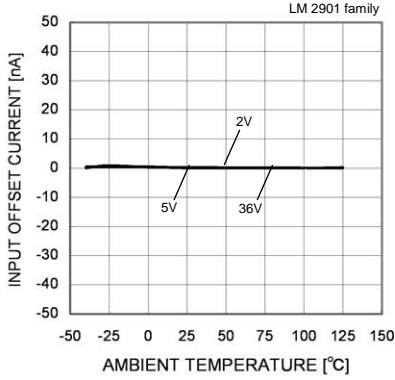

Fig. 76  
Input Offset Current – Ambient Temperature

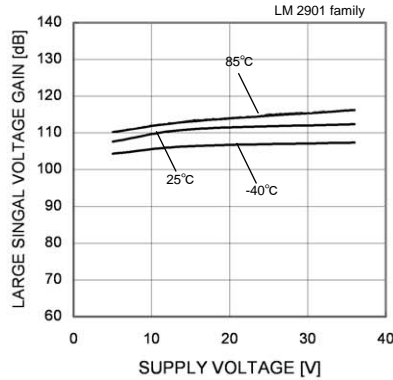

Fig. 77  
Large Signal Voltage Gain – Supply Voltage

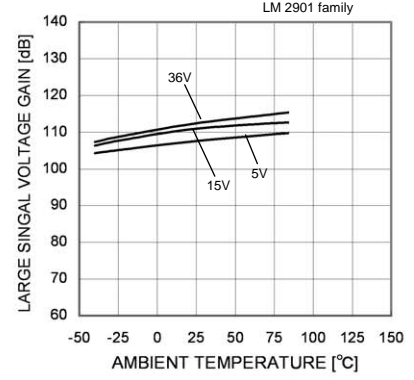

Fig. 78  
Large Signal Voltage Gain – Ambient Temperature

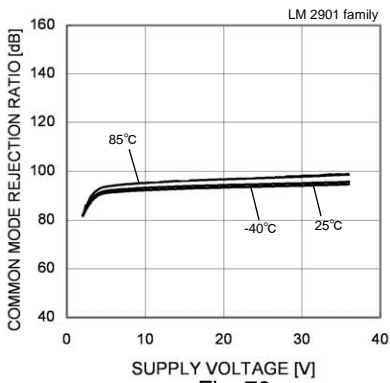

Fig. 79  
Common Mode Rejection Ratio – Supply Voltage

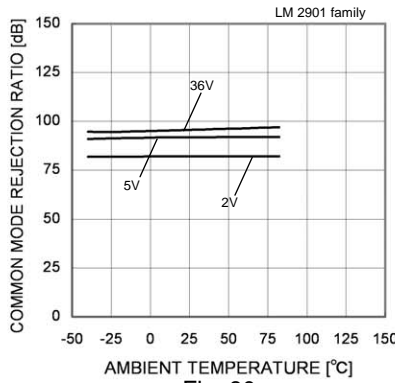

Fig. 80  
Common Mode Rejection Ratio – Ambient Temperature

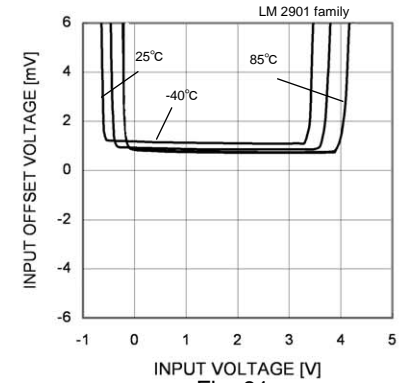

Fig. 81  
Input Offset Voltage – Input Voltage (VCC=5V)

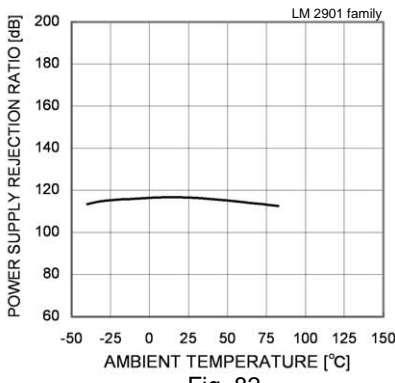

Fig. 82  
Power Supply Rejection Ratio – Ambient Temperature

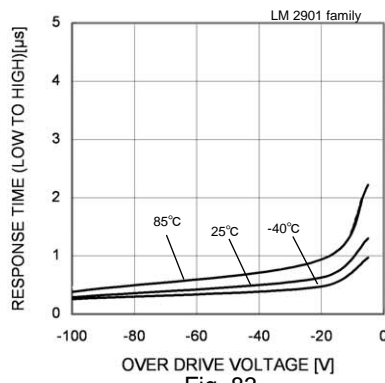

Fig. 83  
Response Time (Low to High) – Over Drive Voltage (VCC=5[V],VRL=5[V],RL=5.1[kΩ])

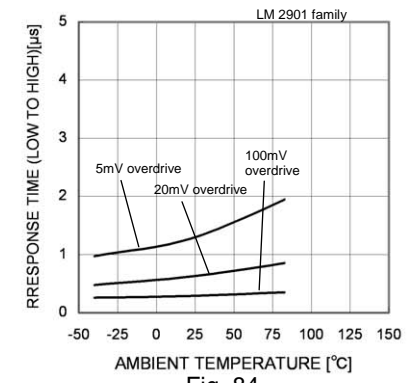

Fig. 84  
Response Time (Low to High) – Ambient Temperature (VCC=5[V],VRL=5[V],RL=5.1[kΩ])

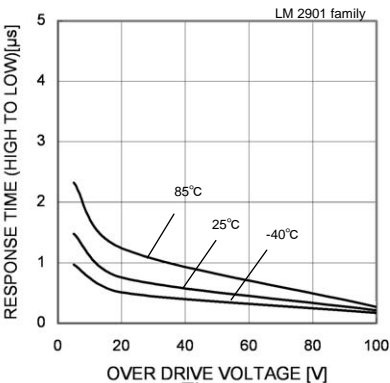

Fig. 85  
Response Time (High to Low) – Over Drive Voltage

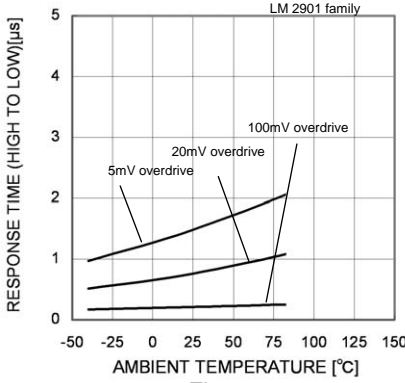

Fig. 86  
Response Time (High to Low) – Ambient Temperature

(\*)The data above is ability value of sample, it is not guaranteed. LM2903family:-40[°C]~+85[°C]

●Circuit Diagram

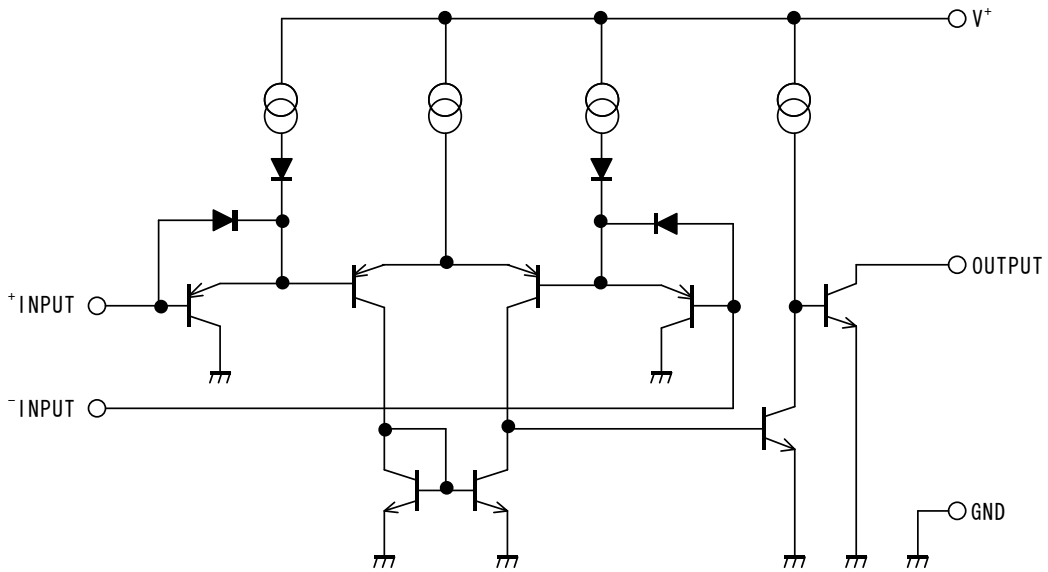

Fig.87 Circuit Diagram (each Comparator)

●Measurement circuit 1 NULL Method measurement condition

V+,GND,EK,VICR unit : [V]

Parameter	VF	S1	S2	S3	LM393/LM339 family				LM2903/LM2901 family				Calculation
					V+	GND	EK	VICR	V+	GND	EK	VICR	
Input Offset Voltage	VF1	ON	ON	ON	5 to 30	0	-1.4	0	5 to 30	0	-1.4	0	1
Input Offset Current	VF2	OFF	OFF	ON	5	0	-1.4	0	5	0	-1.4	0	2
Input Bias Current	VF3	OFF	ON	ON	5	0	-1.4	0	5	0	-1.4	0	3
	VF4	ON	OFF		5	0	-1.4	0	5	0	-1.4	0	
Voltage Gain	VF5	ON	ON	ON	15	0	-1.4	0	15	0	-1.4	0	4
	VF6				15	0	-11.4	0	15	0	-11.4	0	

— Calculation —

1.Input offset voltage (VIO)

$$V_{io} = \frac{|VF1|}{1 + R_f/R_s} \text{ [V]}$$

2.Input offset current (IIO)

$$I_{io} = \frac{|VF2 - VF1|}{R_i(1 + R_f/R_s)} \text{ [A]}$$

3.Input bias current (IIB)

$$I_b = \frac{|VF4 - VF3|}{2 \times R_i(1 + R_f/R_s)} \text{ [A]}$$

4.Voltage gain (AVD)

$$AV = 20 \times \text{Log} \frac{10 \times (1 + R_f/R_s)}{|VF6 - VF5|} \text{ [dB]}$$

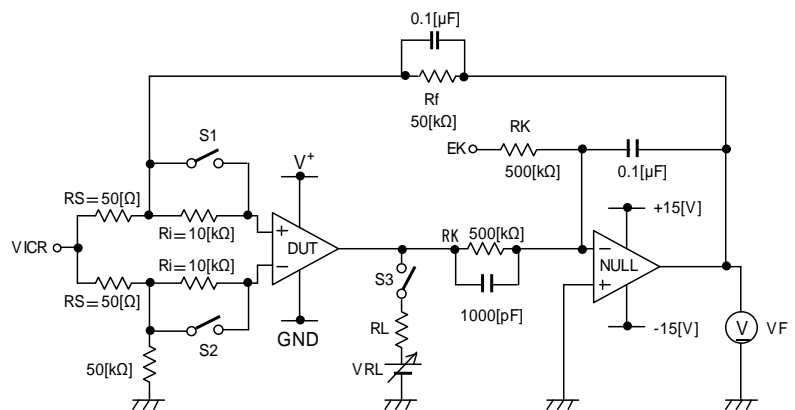

Fig.88 Measurement Circuit1 (each Comparator)

●Measurement Circuit 2: Switch Condition

SW No.		SW 1	SW 2	SW 3	SW 4	SW 5	SW 6	SW 7
Supply Current	—	OFF	OFF	OFF	OFF	OFF	OFF	OFF
Output Sink Current	VOL=1.5[V]	OFF	ON	ON	OFF	ON	ON	OFF
Saturation Voltage	IOL=4[mA]	OFF	ON	ON	OFF	OFF	OFF	ON
Output Leakage Current	VOH=36[V]	OFF	ON	ON	OFF	OFF	OFF	ON
Response Time	RL=5.1[kΩ]	ON	OFF	ON	ON	OFF	ON	OFF
	VRL=5[V]							

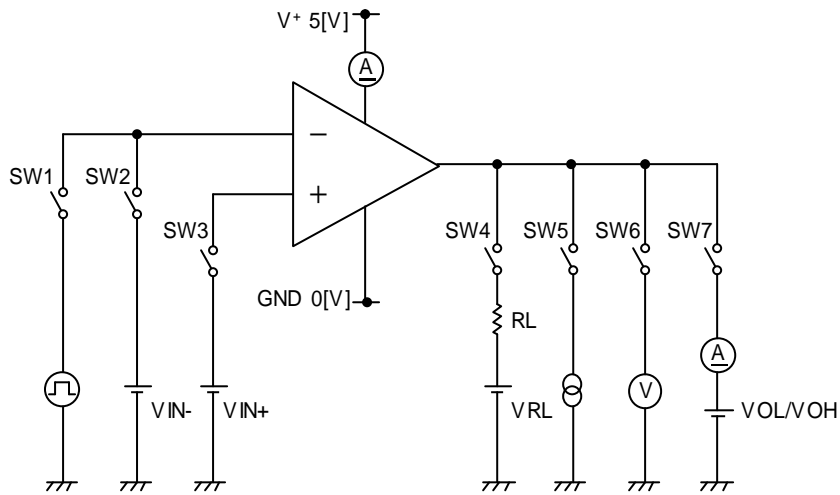

Fig.89 Measurement Circuit 2 (each Comparator)

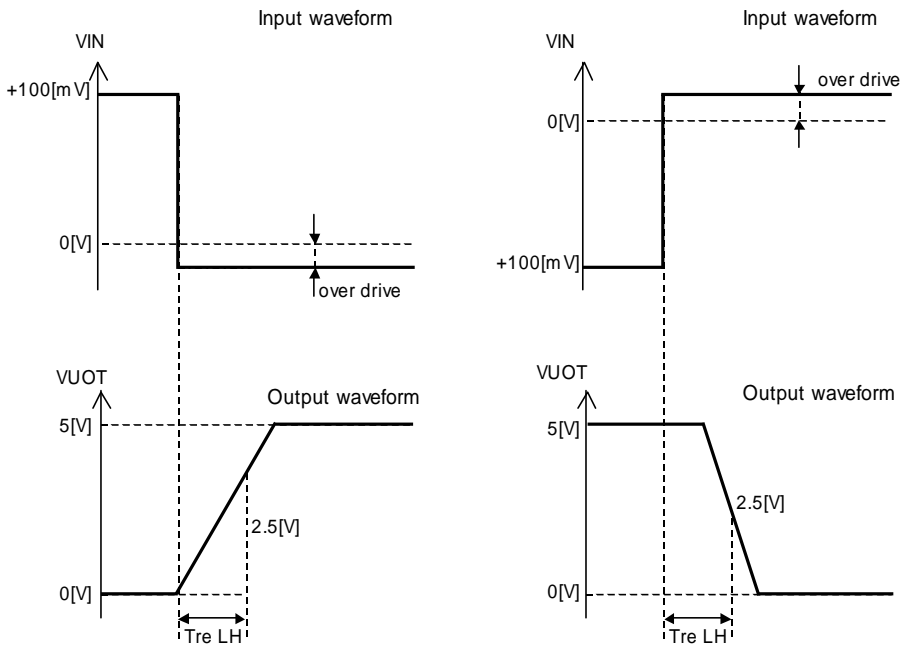

Fig.90 Response Time

## ●Description of electrical characteristics

Described below are descriptions of the relevant electrical terms.

Please note that item names, symbols, and their meanings may differ from those on another manufacturer's documents.

### 1. Absolute maximum ratings

The absolute maximum ratings are values that should never be exceeded, since doing so may result in deterioration of electrical characteristics or damage to the part itself as well as peripheral components.

#### 1.1 Power supply voltage ( $V^+$ /GND)

Expresses the maximum voltage that can be supplied between the positive and negative power supply terminals without causing deterioration of the electrical characteristics or destruction of the internal circuitry.

#### 1.2 Differential input voltage (VID)

Indicates the maximum voltage that can be supplied between the non-inverting and inverting terminals without damaging the IC.

#### 1.3 Input common-mode voltage range (VICR)

Signifies the maximum voltage that can be supplied to non-inverting and inverting terminals without causing deterioration of the electrical characteristics or damage to the IC itself. Normal operation is not guaranteed within the input common-mode voltage range of the maximum ratings – use within the input common-mode voltage range of the electric characteristics instead.

#### 1.4 Operating temperature range and storage temperature range ( $T_{opr}$ , $T_{stg}$ )

The operating temperature range indicates the temperature range within which the IC can operate. The higher the ambient temperature, the lower the power consumption of the IC. The storage temperature range denotes the range of temperatures the IC can be stored under without causing excessive deterioration of the electrical characteristics.

#### 1.5 Power dissipation ( $P_d$ )

Indicates the power that can be consumed by a particular mounted board at ambient temperature (25°C). For packaged products,  $P_d$  is determined by maximum junction temperature and the thermal resistance.

### 2. Electrical characteristics

#### 2.1 Input offset voltage (VIO)

Signifies the voltage difference between the non-inverting and inverting terminals. It can be thought of as the input voltage difference required for setting the output voltage to 0V.

#### 2.2 Input offset current (IIO)

Indicates the difference of the input bias current between the non-inverting and inverting terminals.

#### 2.3 Input bias current (IIB)

Denotes the current that flows into or out of the input terminal, it is defined by the average of the input bias current at the non-inverting terminal and the input bias current at the inverting terminal.

#### 2.4 Input common-mode voltage range (VICR)

Indicates the input voltage range under which the IC operates normally.

#### 2.5 Large signal voltage gain (AVD)

The amplifying rate (gain) of the output voltage against the voltage difference between the non-inverting and inverting terminals, it is (normally) the amplifying rate (gain) with respect to DC voltage.

$AVD = (\text{output voltage fluctuation}) / (\text{input offset fluctuation})$

#### 2.6 Circuit current (ICC)

Indicates the current of the IC itself that flows under specific conditions and during no-load steady state.

#### 2.7 Output sink current (IOL)

Denotes the maximum current that can be output under specific output conditions.

#### 2.8 Output saturation voltage low level output voltage (VOL)

Signifies the voltage range that can be output under specific output conditions.

#### 2.9 Output leakage current (ILeak)

Indicates the current that flows into the IC under specific input and output conditions.

#### 2.10 Response time ( $t_{re}$ )

The interval between the application of input and output conditions.

#### 2.11 Common-mode rejection ratio (CMRR)

Denotes the ratio of fluctuation of the input offset voltage when the in-phase input voltage is changed (DC fluctuation).

$CMRR = (\text{change of input common-mode voltage}) / (\text{input offset fluctuation})$

#### 2.12 Power supply rejection ratio (PSRR)

Signifies the ratio of fluctuation of the input offset voltage when the supply voltage is changed (DC fluctuation).

$PSRR = (\text{change in power supply voltage}) / (\text{input offset fluctuation})$

●Derating Curves

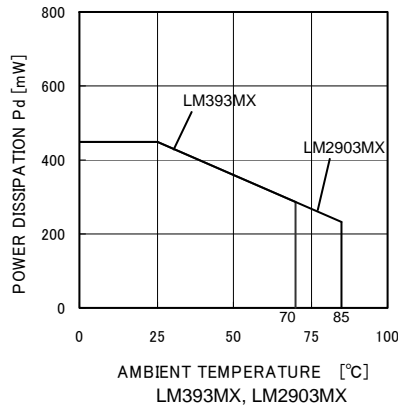

Power Dissipation

Package	Pd[W]	$\theta_{ja}$ [°C/W]
SO package8 (*8)	450	3.6

$$\theta_{ja} = (T_j - T_a) / P_d [°C/W]$$

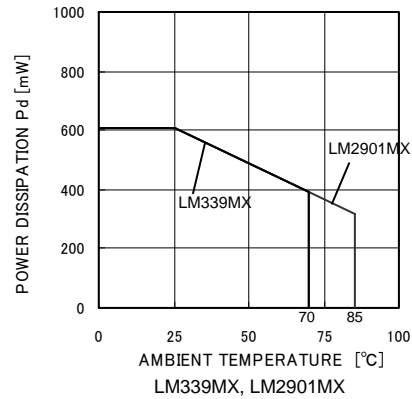

Power Dissipation

Package	Pd[W]	$\theta_{ja}$ [°C/W]
SO package14	610	4.9

$$\theta_{ja} = (T_j - T_a) / P_d [°C/W]$$

Fig.102 Derating Curves

●Notes for use

- Unused circuits  
When there are unused circuits it is recommended that they be connected as in Fig. 103, setting the non-inverting input terminal to a potential within the in-phase input voltage range (VICR).
- Input terminal voltage  
Applying GND + 36V to the input terminal is possible without causing deterioration of the electrical characteristics or destruction, irrespective of the supply voltage. However, this does not ensure normal circuit operation. Please note that the circuit operates normally only when the input voltage is within the common mode input voltage range of the electric characteristics.
- Power supply (single / dual)  
The op-amp operates when the specified voltage supplied is between V<sup>+</sup> and GND. Therefore, the single supply op-amp can be used as a dual supply op-amp as well.
- Power dissipation Pd  
Using the unit in excess of the rated power dissipation may cause deterioration in electrical characteristics due to a rise in chip temperature, including reduced current capability. Therefore, please take into consideration the power dissipation (Pd) under actual operating conditions and apply a sufficient margin in thermal design. Refer to the thermal derating curves for more information.
- Short-circuit between pins and erroneous mounting  
Incorrect mounting may damage the IC. In addition, the presence of foreign particles between the outputs, the output and the power supply, or the output and GND may result in IC destruction.
- Terminal short-circuits  
When the output and V<sup>+</sup> terminals are shorted, excessive output current may flow, resulting in undue heat generation and, subsequently, destruction.
- Operation in a strong electromagnetic field  
Operation in a strong electromagnetic field may cause malfunctions.
- Radiation  
This IC is not designed to withstand radiation.
- IC handling  
Applying mechanical stress to the IC by deflecting or bending the board may cause fluctuations in the electrical characteristics due to piezoelectric (piezo) effects.
- Board inspection  
Connecting a capacitor to a pin with low impedance may stress the IC. Therefore, discharging the capacitor after every process is recommended. In addition, when attaching and detaching the jig during the inspection phase, ensure that the power is turned OFF before inspection and removal. Furthermore, please take measures against ESD in the assembly process as well as during transportation and storage.

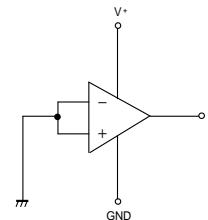

Fig.103

●Ordering part number

L	M	3	3	9
---	---	---	---	---

Family name  
LM393  
LM339  
LM2901  
LM2903

M
---

Package  
M : S.O package

X
---

Packaging and forming specification  
X: Embossed tape and reel

S.O package8

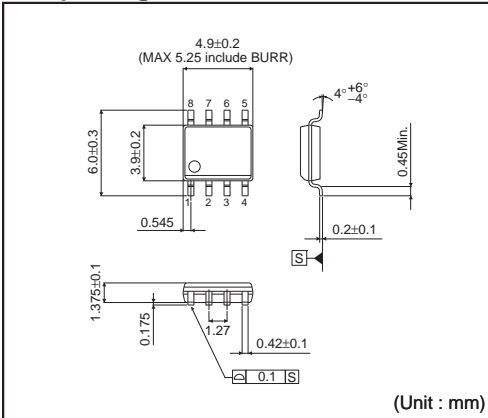

<Tape and Reel information>

Tape	Embossed carrier tape
Quantity	2500pcs
Direction of feed	( The direction is the 1pin of product is at the upper left when you hold reel on the left hand and you pull out the tape on the right hand )

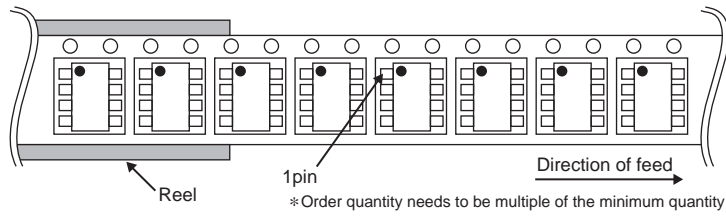

S.O package14

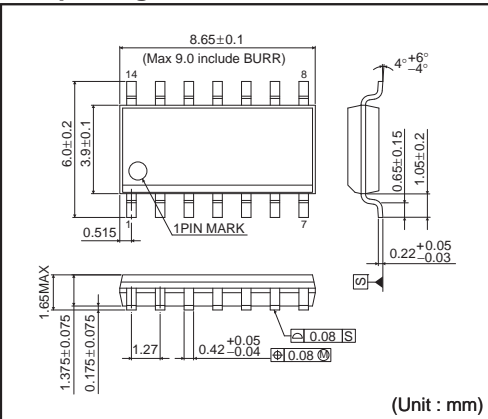

<Tape and Reel information>

Tape	Embossed carrier tape
Quantity	2500pcs
Direction of feed	( The direction is the 1pin of product is at the upper left when you hold reel on the left hand and you pull out the tape on the right hand )

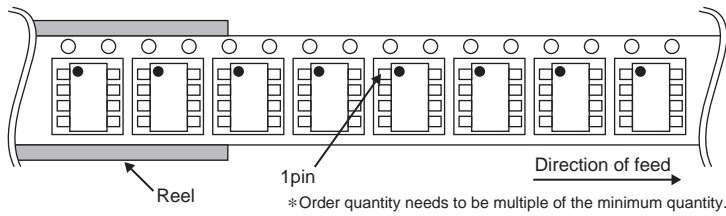



# Notice

## Precaution on using ROHM Products

- Our Products are designed and manufactured for application in ordinary electronic equipments (such as AV equipment, OA equipment, telecommunication equipment, home electronic appliances, amusement equipment, etc.). If you intend to use our Products in devices requiring extremely high reliability (such as medical equipment <sup>(Note 1)</sup>, transport equipment, traffic equipment, aircraft/spacecraft, nuclear power controllers, fuel controllers, car equipment including car accessories, safety devices, etc.) and whose malfunction or failure may cause loss of human life, bodily injury or serious damage to property ("Specific Applications"), please consult with the ROHM sales representative in advance. Unless otherwise agreed in writing by ROHM in advance, ROHM shall not be in any way responsible or liable for any damages, expenses or losses incurred by you or third parties arising from the use of any ROHM's Products for Specific Applications.

(Note1) Medical Equipment Classification of the Specific Applications

JAPAN	USA	EU	CHINA
CLASS III	CLASS III	CLASS II b	CLASS III
CLASS IV		CLASS III	

- ROHM designs and manufactures its Products subject to strict quality control system. However, semiconductor products can fail or malfunction at a certain rate. Please be sure to implement, at your own responsibilities, adequate safety measures including but not limited to fail-safe design against the physical injury, damage to any property, which a failure or malfunction of our Products may cause. The following are examples of safety measures:
  - Installation of protection circuits or other protective devices to improve system safety
  - Installation of redundant circuits to reduce the impact of single or multiple circuit failure
- Our Products are designed and manufactured for use under standard conditions and not under any special or extraordinary environments or conditions, as exemplified below. Accordingly, ROHM shall not be in any way responsible or liable for any damages, expenses or losses arising from the use of any ROHM's Products under any special or extraordinary environments or conditions. If you intend to use our Products under any special or extraordinary environments or conditions (as exemplified below), your independent verification and confirmation of product performance, reliability, etc. prior to use, must be necessary:
  - Use of our Products in any types of liquid, including water, oils, chemicals, and organic solvents
  - Use of our Products outdoors or in places where the Products are exposed to direct sunlight or dust
  - Use of our Products in places where the Products are exposed to sea wind or corrosive gases, including Cl<sub>2</sub>, H<sub>2</sub>S, NH<sub>3</sub>, SO<sub>2</sub>, and NO<sub>2</sub>
  - Use of our Products in places where the Products are exposed to static electricity or electromagnetic waves
  - Use of our Products in proximity to heat-producing components, plastic cords, or other flammable items
  - Sealing or coating our Products with resin or other coating materials
  - Use of our Products without cleaning residue of flux (even if you use no-clean type fluxes, cleaning residue of flux is recommended); or Washing our Products by using water or water-soluble cleaning agents for cleaning residue after soldering
  - Use of the Products in places subject to dew condensation
- The Products are not subject to radiation-proof design.
- Please verify and confirm characteristics of the final or mounted products in using the Products.
- In particular, if a transient load (a large amount of load applied in a short period of time, such as pulse. is applied, confirmation of performance characteristics after on-board mounting is strongly recommended. Avoid applying power exceeding normal rated power; exceeding the power rating under steady-state loading condition may negatively affect product performance and reliability.
- De-rate Power Dissipation (Pd) depending on Ambient temperature (Ta). When used in sealed area, confirm the actual ambient temperature.
- Confirm that operation temperature is within the specified range described in the product specification.
- ROHM shall not be in any way responsible or liable for failure induced under deviant condition from what is defined in this document.

## Precaution for Mounting / Circuit board design

- When a highly active halogenous (chlorine, bromine, etc.) flux is used, the residue of flux may negatively affect product performance and reliability.
- In principle, the reflow soldering method must be used; if flow soldering method is preferred, please consult with the ROHM representative in advance.

For details, please refer to ROHM Mounting specification

### Precautions Regarding Application Examples and External Circuits

1. If change is made to the constant of an external circuit, please allow a sufficient margin considering variations of the characteristics of the Products and external components, including transient characteristics, as well as static characteristics.
2. You agree that application notes, reference designs, and associated data and information contained in this document are presented only as guidance for Products use. Therefore, in case you use such information, you are solely responsible for it and you must exercise your own independent verification and judgment in the use of such information contained in this document. ROHM shall not be in any way responsible or liable for any damages, expenses or losses incurred by you or third parties arising from the use of such information.

### Precaution for Electrostatic

This Product is electrostatic sensitive product, which may be damaged due to electrostatic discharge. Please take proper caution in your manufacturing process and storage so that voltage exceeding the Products maximum rating will not be applied to Products. Please take special care under dry condition (e.g. Grounding of human body / equipment / solder iron, isolation from charged objects, setting of ionizer, friction prevention and temperature / humidity control).

### Precaution for Storage / Transportation

1. Product performance and soldered connections may deteriorate if the Products are stored in the places where:
  - [a] the Products are exposed to sea winds or corrosive gases, including Cl<sub>2</sub>, H<sub>2</sub>S, NH<sub>3</sub>, SO<sub>2</sub>, and NO<sub>2</sub>
  - [b] the temperature or humidity exceeds those recommended by ROHM
  - [c] the Products are exposed to direct sunshine or condensation
  - [d] the Products are exposed to high Electrostatic
2. Even under ROHM recommended storage condition, solderability of products out of recommended storage time period may be degraded. It is strongly recommended to confirm solderability before using Products of which storage time is exceeding the recommended storage time period.
3. Store / transport cartons in the correct direction, which is indicated on a carton with a symbol. Otherwise bent leads may occur due to excessive stress applied when dropping of a carton.
4. Use Products within the specified time after opening a humidity barrier bag. Baking is required before using Products of which storage time is exceeding the recommended storage time period.

### Precaution for Product Label

QR code printed on ROHM Products label is for ROHM's internal use only.

### Precaution for Disposition

When disposing Products please dispose them properly using an authorized industry waste company.

### Precaution for Foreign Exchange and Foreign Trade act

Since our Products might fall under controlled goods prescribed by the applicable foreign exchange and foreign trade act, please consult with ROHM representative in case of export.

### Precaution Regarding Intellectual Property Rights

1. All information and data including but not limited to application example contained in this document is for reference only. ROHM does not warrant that foregoing information or data will not infringe any intellectual property rights or any other rights of any third party regarding such information or data. ROHM shall not be in any way responsible or liable for infringement of any intellectual property rights or other damages arising from use of such information or data.:
2. No license, expressly or implied, is granted hereby under any intellectual property rights or other rights of ROHM or any third parties with respect to the information contained in this document.

### Other Precaution

1. This document may not be reprinted or reproduced, in whole or in part, without prior written consent of ROHM.
2. The Products may not be disassembled, converted, modified, reproduced or otherwise changed without prior written consent of ROHM.
3. In no event shall you use in any way whatsoever the Products and the related technical information contained in the Products or this document for any military purposes, including but not limited to, the development of mass-destruction weapons.
4. The proper names of companies or products described in this document are trademarks or registered trademarks of ROHM, its affiliated companies or third parties.

**General Precaution**

1. Before you use our Products, you are requested to carefully read this document and fully understand its contents. ROHM shall not be in any way responsible or liable for failure, malfunction or accident arising from the use of any ROHM's Products against warning, caution or note contained in this document.
2. All information contained in this document is current as of the issuing date and subject to change without any prior notice. Before purchasing or using ROHM's Products, please confirm the latest information with a ROHM sales representative.
3. The information contained in this document is provided on an "as is" basis and ROHM does not warrant that all information contained in this document is accurate and/or error-free. ROHM shall not be in any way responsible or liable for any damages, expenses or losses incurred by you or third parties resulting from inaccuracy or errors of or concerning such information.

# AMEYA360

## Components Supply Platform

### Authorized Distribution Brand :



### Website :

Welcome to visit [www.ameya360.com](http://www.ameya360.com)

### Contact Us :

#### ➤ Address :

401 Building No.5, JiuGe Business Center, Lane 2301, Yishan Rd  
Minhang District, Shanghai , China

#### ➤ Sales :

Direct +86 (21) 6401-6692

Email [amall@ameya360.com](mailto:amall@ameya360.com)

QQ 800077892

Skype [ameyasales1](#) [ameyasales2](#)

#### ➤ Customer Service :

Email [service@ameya360.com](mailto:service@ameya360.com)

#### ➤ Partnership :

Tel +86 (21) 64016692-8333

Email [mkt@ameya360.com](mailto:mkt@ameya360.com)