



LOW-POWER CAN TRANSCEIVER WITH BUS WAKE-UP

FEATURES

- Improved Drop-in Replacement for the TJA1040
- ± 12 kV ESD Protection
- Low-Current Standby Mode with Bus Wake-up: 5 μ A Typical
- Bus-Fault Protection of -27 V to 40 V
- Rugged Split-Pin Bus Stability
- Dominant Time-Out Function
- Power-Up/Down Glitch-Free Bus Inputs and Outputs
 - High Input Impedance with Low V_{CC}
 - Monotonic Outputs During Power Cycling
- DeviceNet Vendor ID # 806

APPLICATIONS

- Battery Operated Applications
- Hand-Held Diagnostics
- Medical Scanning and Imaging
- HVAC
- Security Systems
- Telecom Base Station Status and Control
- SAE J1939 Standard Data Bus Interface
- NMEA 2000 Standard Data Bus Interface
- ISO 11783 Standard Data Bus Interface
- Industrial Automation
 - DeviceNet™ Data Buses

DESCRIPTION

The SN65HVD1040 meets or exceeds the specifications of the ISO 11898 standard for use in applications employing a Controller Area Network (CAN). As CAN transceivers, these devices provide differential transmit and receive capability for a CAN controller at signaling rates of up to 1 megabit per second (Mbps). ⁽¹⁾

Designed for operation in especially harsh environments, the device features ± 12 kV ESD protection on the bus and split pins, cross-wire, overvoltage and loss of ground protection from -27 to 40 V, overtemperature shutdown, a -12 V to 12 V common-mode range, and will withstand voltage transients from -200 V to 200 V according to ISO 7637.

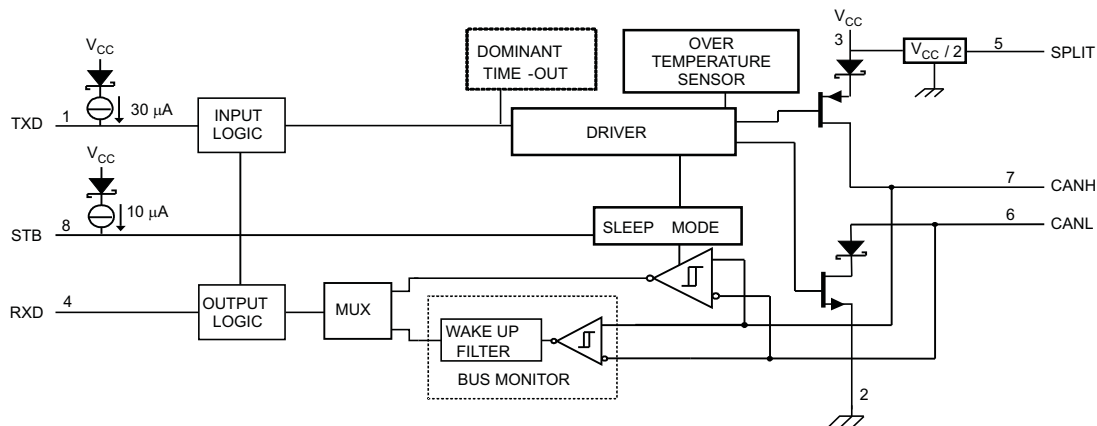

(1) The signaling rate of a line is the number of voltage transitions that are made per second expressed in the units bps (bits per second).



Please be aware that an important notice concerning availability, standard warranty, and use in critical applications of Texas Instruments semiconductor products and disclaimers thereto appears at the end of this data sheet.

DeviceNet is a trademark of Texas Instruments.



These devices have limited built-in ESD protection. The leads should be shorted together or the device placed in conductive foam during storage or handling to prevent electrostatic damage to the MOS gates.

DESCRIPTION (Continued)

The STB input (pin 8) selects between two different modes of operation; high-speed or low-power mode. The high-speed mode of operation is selected by connecting STB to ground.

If a high logic level is applied to the STB pin of the SN65HVD1040, the device enters a low-power bus-monitor standby mode. While the SN65HVD1040 is in the low-power bus-monitor standby mode, a dominant bit greater than 5 μs on the bus is passed by the bus-monitor circuit to the receiver output. The local protocol controller may then reactivate the device when it needs to transmit to the bus.

A dominant-time-out circuit in the SN65HVD1040 prevents the driver from blocking network communication during a hardware or software failure. The time-out circuit is triggered by a falling edge on TXD (pin 1). If no rising edge is seen before the time-out constant of the circuit expires, the driver is disabled. The circuit is then reset by the next rising edge on TXD.

The SPLIT output (pin 5) is available on the SN65HVD1040 as a $V_{CC}/2$ common-mode bus voltage bias for a split-termination network.

The SN65HVD1040 is characterized for operation from –40°C to 125°C.

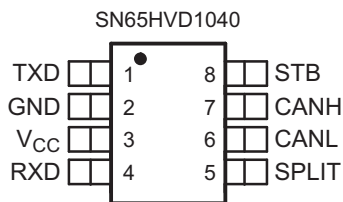

ORDERING INFORMATION

PART NUMBER	DOMINANT TIME-OUT	LOW-POWER BUS MONITOR	PACKAGE ⁽¹⁾	MARKED AS	ORDERING NUMBER
SN65HVD1040	YES	YES	SOIC-8	VP1040	SN65HVD1040D (rail)
					SN65HVD1040DR (reel)

(1) For the most current package and ordering information, see the Package Option Addendum at the end of this document, or see the TI website at www.ti.com.

ABSOLUTE MAXIMUM RATINGS⁽¹⁾

			VALUE
V_{CC}	Supply voltage ⁽²⁾		-0.3 V to 7 V
$V_{I(\text{bus})}$	Voltage range at any bus terminal (CANH, CANL, SPLIT)		-27 V to 40 V
$I_{O(\text{OUT})}$	Receiver output current		-20 mA to 20 mA
	Voltage input, transient pulse ⁽³⁾ , (CANH, CANL, SPLIT)		-200 V to 200 V
ESD	IEC Contact Discharge	(IEC 61000-4-2)	Bus terminals vs GND ± 6 kV
	Human body model	JEDEC Standard 22, Test Method A114-C.01	Bus terminals vs GND ± 12 kV
			All pins ± 4 kV
	Field-Induced-Charged Device Model	JEDEC Standard 22, Test Method C101	All pins ± 1 kV
Machine model	ANSI/ESDS5.2-1996	± 200 V	
IEC			Bus terminals vs GND ± 6 kV
V_I	Voltage input range (TXD, STB)		-0.5 V to 6 V
T_J	Junction temperature		-55°C to 170°C

- (1) Stresses beyond those listed under "absolute maximum ratings" may cause permanent damage to the device. These are stress ratings only and functional operation of the device at these or any other conditions beyond those indicated under "recommended operating conditions" is not implied. Exposure to absolute-maximum-rated conditions for extended periods may affect device reliability.
- (2) All voltage values, except differential I/O bus voltages, are with respect to network ground terminal.
- (3) Tested in accordance with ISO 7637, test pulses 1, 2, 3a, 3b, 5, 6 & 7.

RECOMMENDED OPERATING CONDITIONS

			MIN	NOM	MAX	UNIT
V_{CC}	Supply voltage		4.75		5.25	V
V_I or V_{IC}	Voltage at any bus terminal (separately or common mode)		-12 ⁽¹⁾		12	V
V_{IH}	High-level input voltage	TXD, STB	2		5.25	V
V_{IL}	Low-level input voltage		0		0.8	V
V_{ID}	Differential input voltage		-6		6	V
I_{OH}	High-level output current	Driver	-70			mA
		Receiver	-2			
I_{OL}	Low-level output current	Driver			70	mA
		Receiver			2	
t_{SS}	Maximum pulse width to remain in standby				0.7	μ s
T_J	Junction temperature		-40		150	= C

- (1) The algebraic convention, in which the least positive (most negative) limit is designated as minimum is used in this data sheet.

SUPPLY CURRENT

over operating free-air temperature range (unless otherwise noted)

PARAMETER		TEST CONDITIONS		MIN	TYP	MAX	UNIT
I_{CC}	Supply current, V_{CC}	Dominant	$V_I = 0$ V, 60 Ω Load, STB at 0 V		50	70	mA
		Recessive	$V_I = V_{CC}$, STB at 0 V		6	10	
		Standby	STB at V_{CC} , $V_I = V_{CC}$		5	12	μ A

DEVICE SWITCHING CHARACTERISTICS

over recommended operating conditions (unless otherwise noted)

PARAMETER		TEST CONDITIONS	MIN	TYP	MAX	UNIT
t_{loop1}	Total loop delay, driver input to receiver output, Recessive to Dominant	STB at 0 V, See Figure 9		90	230	ns
t_{loop2}	Total loop delay, driver input to receiver output, Dominant to Recessive			90	230	

DRIVER ELECTRICAL CHARACTERISTICS

over recommended operating conditions (unless otherwise noted)

PARAMETER		TEST CONDITIONS	MIN	TYP ⁽¹⁾	MAX	UNIT	
V _{O(D)}	Bus output voltage (Dominant)	CANH	V _I = 0 V, STB at 0 V, R _L = 60 Ω, See Figure 1 and Figure 2	2.9	3.4	4.5	V
		CANL		0.8		1.75	
V _{O(R)}	Bus output voltage (Recessive)	V _I = 3 V, STB at 0 V, See Figure 1 and Figure 2	2	2.5	3	V	
V _O	Bus output voltage (Standby)	R _L = 60 Ω, STB at V _{CC} , See Figure 1 and Figure 2	–0.1		0.1	V	
V _{OD(D)}	Differential output voltage (Dominant)	V _I = 0 V, R _L = 60 Ω, STB at 0 V, See Figure 1 and Figure 2 , and Figure 3	1.5		3	V	
		V _I = 0 V, R _L = 45 Ω, STB at 0 V, See Figure 1 and Figure 2	1.4		3		
V _{SYM}	Output symmetry (Dominant or Recessive) [V _{O(CANH)} + V _{O(CANL)}]	STB at 0 V, See Figure 2 and Figure 13	0.9×V _{CC}	V _{CC}	1.1×V _{CC}	V	
V _{OD(R)}	Differential output voltage (Recessive)	V _I = 3 V, R _L = 60 Ω, STB at 0 V, See Figure 1 and Figure 2	–0.012		0.012	V	
		V _I = 3 V, STB at 0 V, No Load	–0.5		0.05		
V _{OC(D)}	Common-mode output voltage (Dominant)	STB at 0 V, See Figure 8	2	2.3	3	V	
V _{OC(pp)}	Peak-to-peak common-mode output voltage			0.3			
I _{IH}	High-level input current, TXD input	V _I at V _{CC}	–2		2	μA	
I _{IL}	Low-level input current, TXD input	V _I at 0 V	–50		–10	μA	
I _{O(off)}	Power-off TXD Leakage current	V _{CC} at 0 V, TXD at 5 V			1	μA	
I _{OS(ss)}	Short-circuit steady-state output current	V _{CANH} = –12 V, CANL Open, See Figure 12	–120	–72		mA	
		V _{CANH} = 12 V, CANL Open, See Figure 12		0.36	1		
		V _{CANL} = –12 V, CANH Open, See Figure 12	–1	–0.5			
		V _{CANL} = 12 V, CANH Open, See Figure 12		71	120		
C _O	Output capacitance	See Input capacitance to ground in RECEIVER ELECTRICAL CHARACTERISTICS .					

(1) All typical values are at 25 = C with a 5-V supply.

DRIVER SWITCHING CHARACTERISTICS

over recommended operating conditions (unless otherwise noted)

PARAMETER		TEST CONDITIONS	MIN	TYP	MAX	UNIT
t _{PLH}	Propagation delay time, low-to-high-level output	STB at 0 V, See Figure 4	25	65	120	ns
t _{PHL}	Propagation delay time, high-to-low-level output		25	45	120	
t _{sk(p)}	Pulse skew (t _{PHL} – t _{PLH})				25	
t _r	Differential output signal rise time			25		
t _f	Differential output signal fall time			50		
t _{en}	Enable time from silent mode to dominant	See Figure 7			10	μs
t _{dom}	Dominant time-out	See Figure 10	300	450	700	μs

RECEIVER ELECTRICAL CHARACTERISTICS

over recommended operating conditions (unless otherwise noted)

PARAMETER		TEST CONDITIONS	MIN	TYP ⁽¹⁾	MAX	UNIT
V _{IT+}	Positive-going input threshold voltage	STB at 0 V, See Table 1		800	900	mV
V _{IT-}	Negative-going input threshold voltage		500	650		
V _{hys}	Hysteresis voltage (V _{IT+} – V _{IT-})		100	125		
V _{IT}	Input threshold voltage	Standby mode STB at V _{CC}	500		1150	
V _{OH}	High-level output voltage	I _O = –2 mA, See Figure 6	4	4.6		V
V _{OL}	Low-level output voltage	I _O = 2 mA, See Figure 6		0.2	0.4	V
I _{I(off)}	Power-off bus input current	CANH or CANL = 5 V, V _{CC} at 0 V, TXD at 0 V			5	μA
I _{O(off)}	Power-off RXD leakage current	V _{CC} at 0 V, RXD at 5 V			20	μA
C _I	Input capacitance to ground, (CANH or CANL)	TXD at 3 V, V _I = 0.4 sin(4E6πt) + 2.5 V		20		pF
C _{ID}	Differential input capacitance	TXD at 3 V, V _I = 0.4 sin(4E6πt)		10		pF
R _{ID}	Differential input resistance	TXD at 3 V, STD at 0 V	30		80	kΩ
R _{IN}	Input resistance, (CANH or CANL)	TXD at 3 V, STD at 0 V	15	30	40	
R _{I(m)}	Input resistance matching [1 – (R _{IN (CANH)} / R _{IN (CANL)})] × 100%	V _{CANH} = V _{CANL}	–3%	0%	3%	

(1) All typical values are at 25 = C with a 5-V supply.

RECEIVER SWITCHING CHARACTERISTICS

over recommended operating conditions (unless otherwise noted)

PARAMETER		TEST CONDITIONS	MIN	TYP	MAX	UNIT
t _{pLH}	Propagation delay time, low-to-high-level output	STB at 0 V, TXD at 3 V, See Figure 6	60	100	130	ns
t _{pHL}	Propagation delay time, high-to-low-level output		45	70	130	
t _r	Output signal rise time			8		
t _f	Output signal fall time			8		
t _{BUS}	Dominant time required on bus for wake-up from standby ⁽¹⁾	STB at V _{CC} Figure 11	0.7		5	μs

 (1) The device under test shall not signal a wake-up condition with dominant pulses shorter than t_{BUS} (min) and shall signal a wake-up condition with dominant pulses longer than t_{BUS} (max). Dominant pulses with a length between t_{BUS} (min) and t_{BUS} (max) may lead to a wake-up.

SPLIT-PIN CHARACTERISTICS

over recommended operating conditions (unless otherwise noted)

PARAMETER		TEST CONDITIONS	MIN	TYP	MAX	UNIT
V _O	Output voltage	–500 μA < I _O < 500 μA	0.3×V _{CC}	0.5×V _{CC}	0.7×V _{CC}	V
I _{O(stb)}	Standby mode leakage current	STB at 2 V, –12 V ≤ V _O ≤ 12 V	–5		5	μA

STB-PIN CHARACTERISTICS

over recommended operating conditions (unless otherwise noted)

PARAMETER		TEST CONDITIONS	MIN	TYP	MAX	UNIT
I _{IH}	High level input current	STB at 2 V	–10		0	μA
I _{IL}	Low level input current	STB at 0 V	–10		0	μA

PARAMETER MEASUREMENT INFORMATION

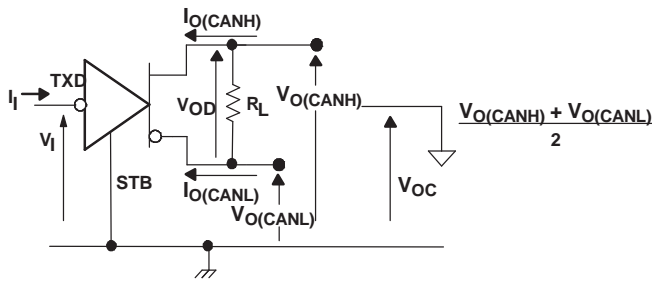

Figure 1. Driver Voltage, Current, and Test Definition

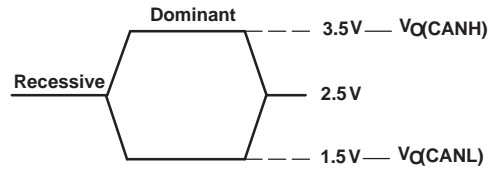

Figure 2. Bus Logic State Voltage Definitions

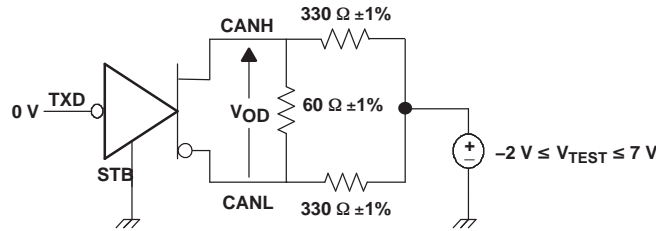

Figure 3. Driver V_{OD} Test Circuit

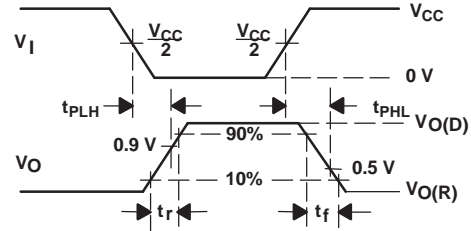
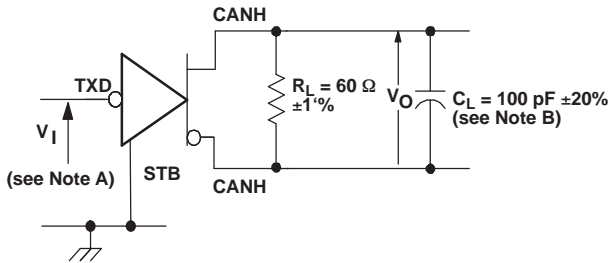

Figure 4. Driver Test Circuit and Voltage Waveforms

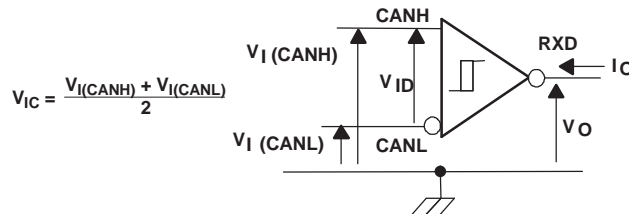
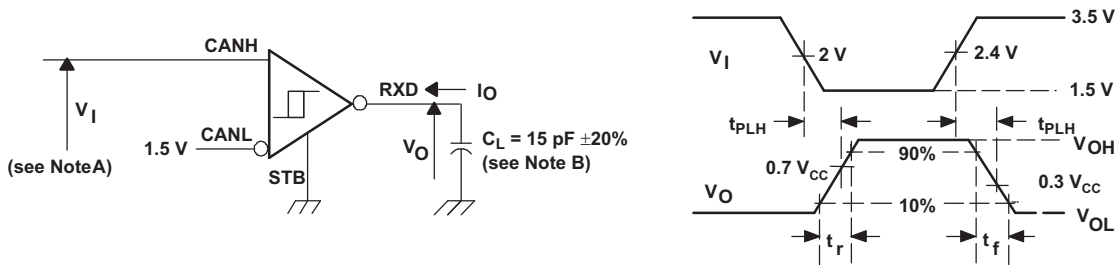

Figure 5. Receiver Voltage and Current Definitions

PARAMETER MEASUREMENT INFORMATION (continued)



- A. The input pulse is supplied by a generator having the following characteristics: PRR ≤ 125 kHz, 50% duty cycle, $t_r \leq 6$ ns, $t_f \leq 6$ ns, $Z_O = 50 \Omega$.
- B. C_L includes instrumentation and fixture capacitance within ±20%.

Figure 6. Receiver Test Circuit and Voltage Waveforms

Table 1. Differential Input Voltage Threshold Test

INPUT			OUTPUT	
V_{CANH}	V_{CANL}	$ V_{ID} $	R	
-11.1 V	-12 V	900 mV	L	V_{OL}
12 V	11.1 V	900 mV	L	
-6 V	-12 V	6 V	L	
12 V	6 V	6 V	L	
-11.5 V	-12 V	500 mV	H	V_{OH}
12 V	11.5 V	500 mV	H	
-12 V	-6 V	6 V	H	
6 V	12 V	6 V	H	
Open	Open	X	H	

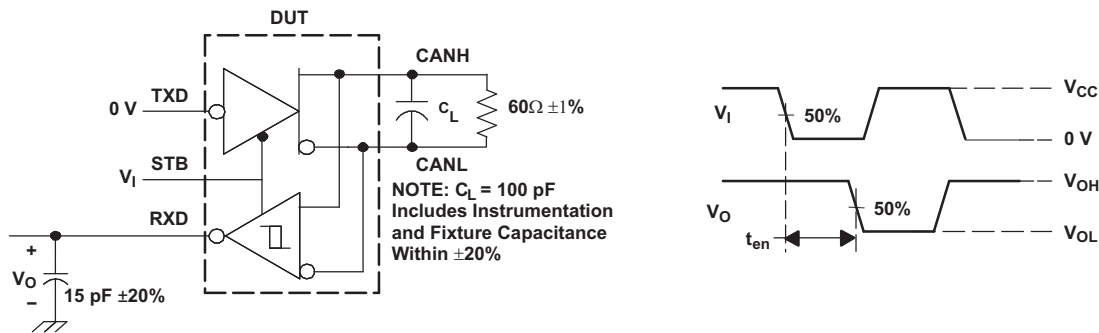
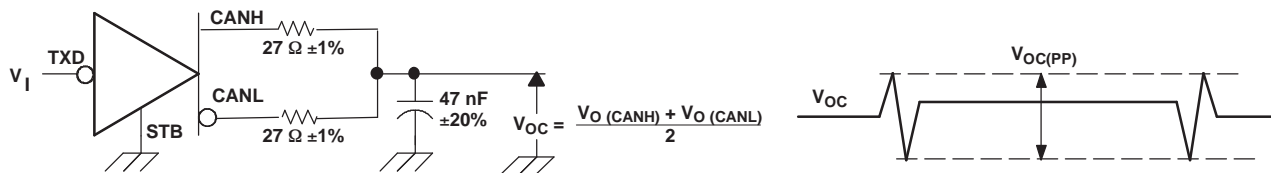
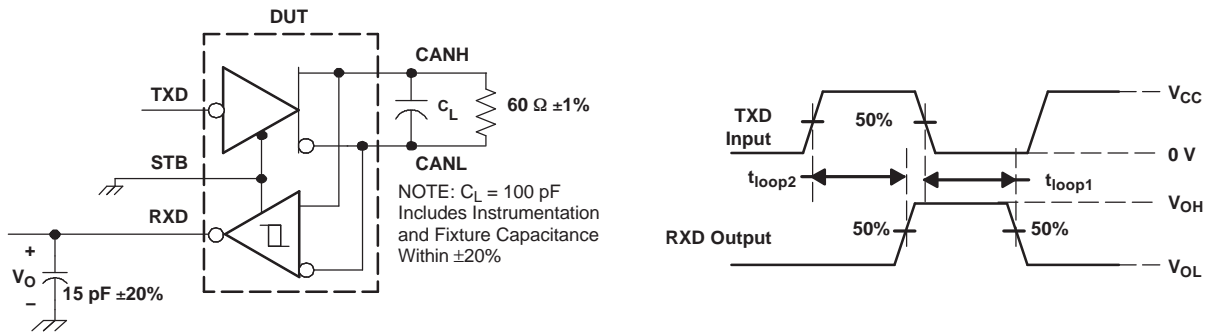

Figure 7. t_{en} Test Circuit and Voltage Waveforms



- A. All V_I input pulses are from 0 V to V_{CC} and supplied by a generator having the following characteristics: t_r or $t_f \leq 6$ ns. Pulse Repetition Rate (PRR) = 125 kHz, 50% duty cycle.

Figure 8. Peak-to-Peak Common Mode Output Voltage Test and Waveform



- A. All V_I input pulses are from 0 V to V_{CC} and supplied by a generator with the following characteristics: t_r or $t_f \leq 6$ ns. Pulse Repetition Rate (PRR) = 125 kHz, 50% duty cycle.

Figure 9. t_{loop} Test Circuit and Voltage Waveforms

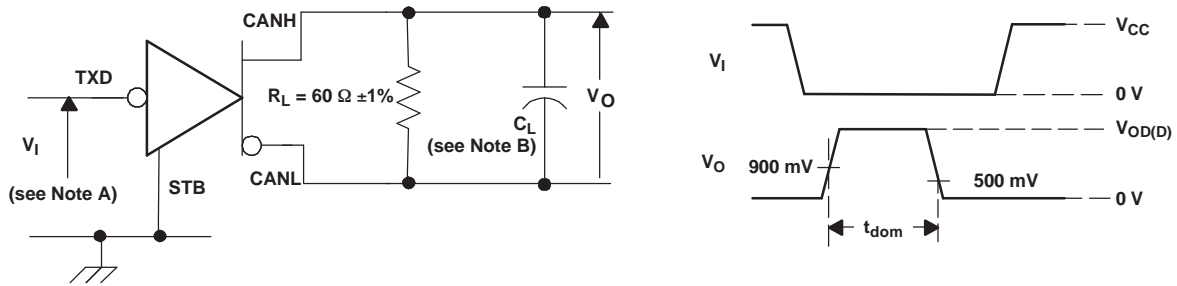

- A. All V_I input pulses are from 0 V to V_{CC} and supplied by a generator with the following characteristics: t_r or $t_f \leq 6$ ns. Pulse Repetition Rate (PRR) = 500 Hz, 50% duty cycle.
- B. $C_L = 100$ pF includes instrumentation and fixture capacitance within $\pm 20\%$.

Figure 10. Dominant Time-Out Test Circuit and Waveform

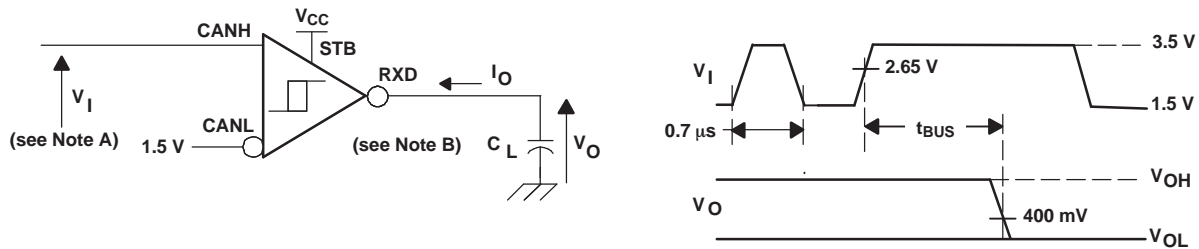

- A. For V_I bit width $\leq 0.7 \mu s$, $V_O = V_{OH}$. For V_I bit width $\geq 5 \mu s$, $V_O = V_{OL}$. V_I input pulses are supplied from a generator with the following characteristics; t_r or $t_f \leq 6$ ns. Pulse Repetition Rate (PRR) = 50 Hz, 30% duty cycle.
- B. $C_L = 15$ pF includes instrumentation and fixture capacitance within $\pm 20\%$.

Figure 11. t_{BUS} Test Circuit and Waveform

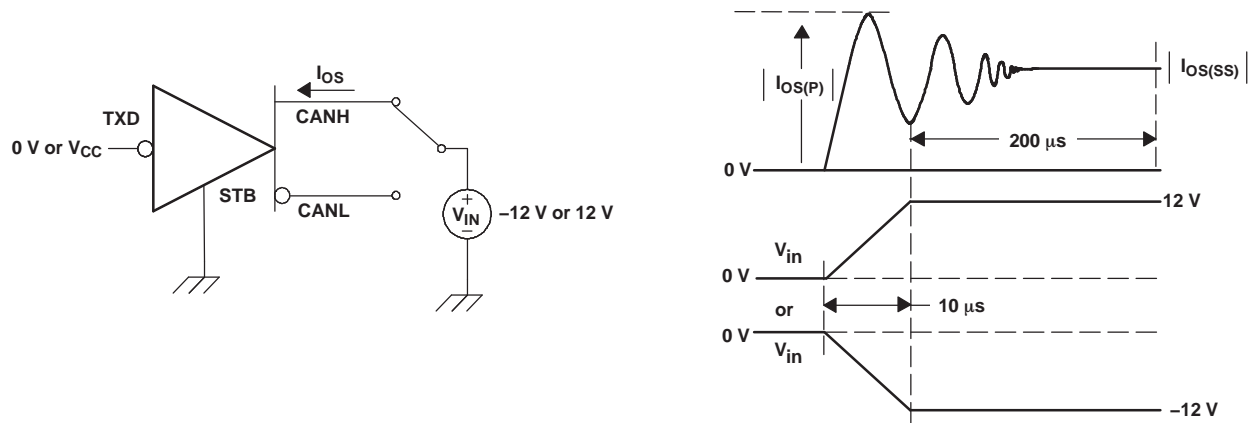

Figure 12. Driver Short-Circuit Current Test and Waveform

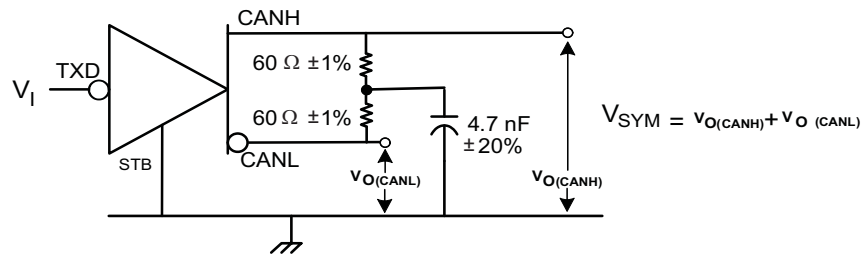

Figure 13. Driver Output Symmetry Test Circuit

DEVICE INFORMATION

Table 2. DRIVER FUNCTION TABLE⁽¹⁾

INPUTS		OUTPUTS		BUS STATE
TXD	STB	CANH	CANL	
L	L	H	L	DOMINANT
H	L	Z	Z	RECESSIVE
Open	X	Z	Z	RECESSIVE
X	H or Open	Z	Z	RECESSIVE

(1) H = high level; L = low level; X = irrelevant; Z = high impedance

Table 3. RECEIVER FUNCTION TABLE⁽¹⁾

DIFFERENTIAL INPUTS $V_{ID} = \text{CANH} - \text{CANL}$	STB	OUTPUT RXD	BUS STATE
$V_{ID} \geq 0.9 \text{ V}$	L	L	DOMINANT
$V_{ID} \geq 1.15 \text{ V}$	H or Open	L	DOMINANT
$0.5 \text{ V} < V_{ID} < 0.9 \text{ V}$	X	?	?
$V_{ID} \leq 0.5 \text{ V}$	X	H	RECESSIVE
Open	X	H	RECESSIVE

(1) H = high level; L = low level; X = irrelevant; ? = indeterminate; Z = high impedance

THERMAL CHARACTERISTICS

over operating free-air temperature range (unless otherwise noted)

PARAMETER		TEST CONDITIONS	MIN	TYP	MAX	UNIT
θ_{JA}	Thermal Resistance, Junction-to-Air	Low-K Thermal Resistance ⁽¹⁾		211		°C/W
		High-K Thermal Resistance		131		°C/W
θ_{JB}	Thermal Resistance, Junction-to-Board			53		°C/W
θ_{JC}	Thermal Resistance, Junction-to-Case			79		
P_D	Device Power Dissipation	$R_L = 60 \Omega$, S at 0 V, Input to TXD a 500kHz 50% duty-cycle square wave		112	170	mW
T_{JS}	Junction Temperature, Thermal Shutdown ⁽²⁾			190		°C

(1) Tested in accordance with the Low-K or High-K thermal metric definitions of EIA/JESD51-3 for leaded surface mount packages.

(2) Extended operation in thermal shutdown may affect device reliability, see the *Application Information* section.

DEVICE INFORMATION
Table 4. Parametric Cross Reference With the TJA1040

TJA1040 ⁽¹⁾	PARAMETER	HVD10xx
TJA1040 DRIVER SECTION		
V _{IH}	High-level input voltage	Recommended V _{IH}
V _{IL}	Low-level input voltage	Recommended V _{IL}
I _{IH}	High-level input current	Driver I _{IH}
I _{IL}	Low-level input current	Driver I _{IL}
TJA1040 BUS SECTION		
V _{th(dif)}	Differential input voltage	Receiver V _{IT} and recommended V _{ID}
V _{hys(dif)}	Differential input hysteresis	Receiver V _{hys}
V _{O(dom)}	Dominant output voltage	Driver V _{O(D)}
V _{O(reces)}	Recessive output voltage	Driver V _{O(R)}
V _{i(dif)(th)}	Differential input voltage	Receiver V _{IT} and recommended V _{ID}
V _{O(dif0)(bus)}	Differential bus voltage	Driver V _{OD(D)} and V _{OD(R)}
I _{LI}	Power-off bus input current	Receiver I _{I(off)}
I _{O(SC)}	Short-circuit output current	Driver I _{OS(SS)}
R _{i(cm)}	CANH, CANL input resistance	Receiver R _{IN}
R _{i(def)}	Differential input resistance	Receiver R _{ID}
R _{i(cm)(m)}	Input resistance matching	Receiver R _{I(m)}
C _{i(cm)}	Input capacitance to ground	Receiver C _I
C _{i(dif)}	Differential input capacitance	Receiver C _{ID}
TJA1040 RECEIVER SECTION		
I _{OH}	High-level output current	Recommended I _{OH}
I _{OL}	Low-level output current	Recommended I _{OL}
TJA1040 SPLIT PIN SECTION		
V _O	Reference output voltage	V _O
TJA1040 TIMING SECTION		
t _{d(TXD-BUSon)}	Delay TXD to bus active	Driver t _{PLH}
t _{d(TXD-BUSoff)}	Delay TXD to bus inactive	Driver t _{PHL}
t _{d(BUSon-RXD)}	Delay bus active to RXD	Receiver t _{PHL}
t _{d(BUSoff-RXD)}	Delay bus inactive to RXD	Receiver t _{PLH}
t _{PD(TXD-RXD)}	Prop delay TXD to RXD	Device t _{LOOP1} and t _{LOOP2}
t _{d(stb-norm)}	Enable time from standby to dominant	Driver t _{en}
TJA1040 STB PIN SECTION		
V _{IH}	High-level input voltage	Recommended V _{IH}
V _{IL}	Low-level input voltage	Recommended V _{IL}
I _{IH}	High-level input current	I _{IH}
I _{IL}	Low-level input current	I _{IL}

(1) From TJA1040 Product Specification, Philips Semiconductors, 2003 February 19.

Equivalent Input and Output Schematic Diagrams

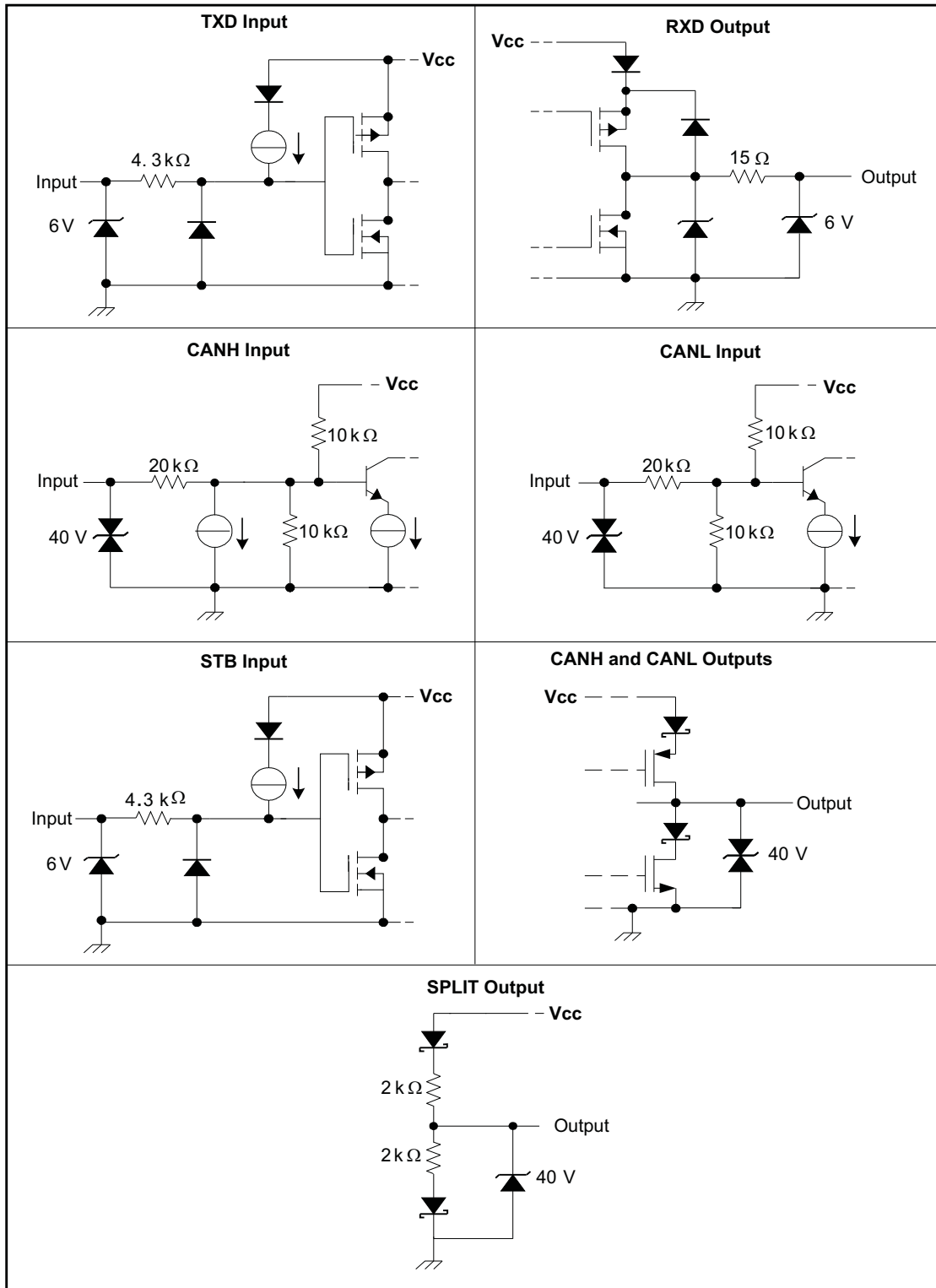

TYPICAL CHARACTERISTICS

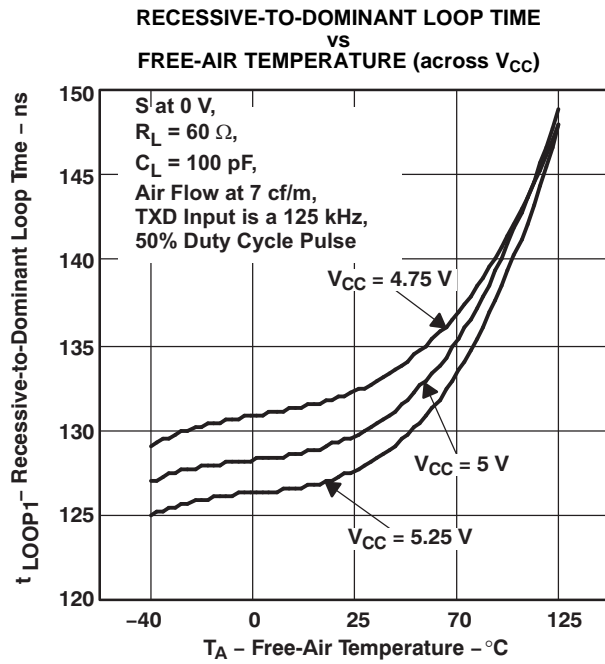

Figure 14.

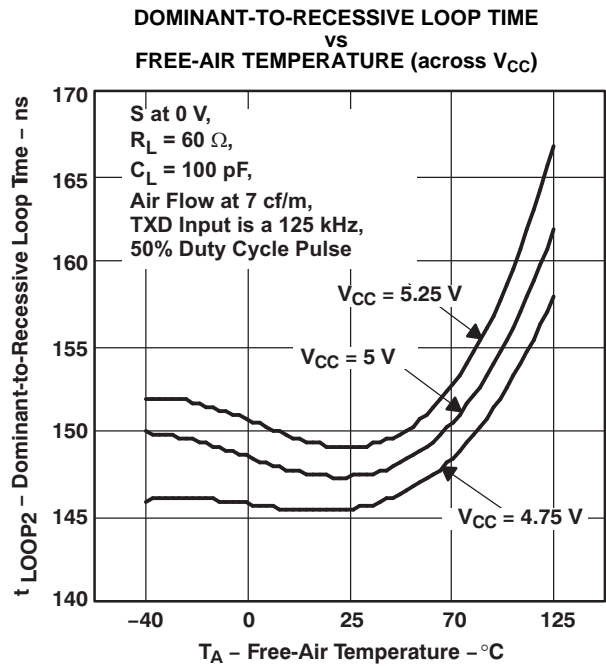

Figure 15.

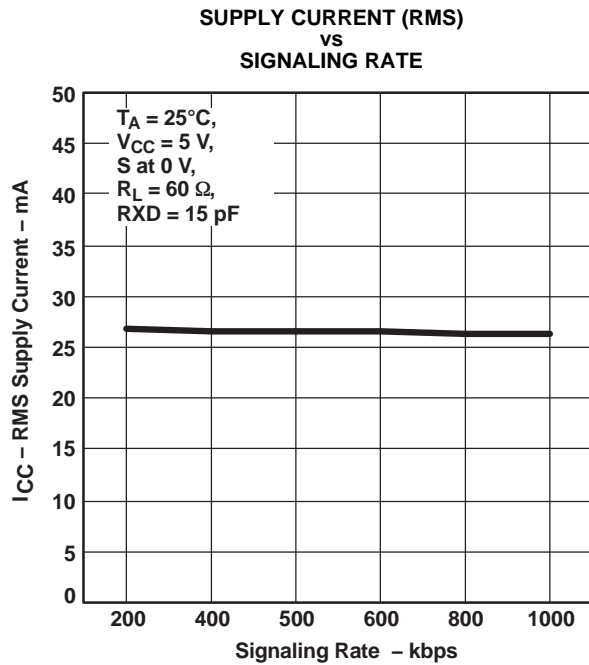

Figure 16.

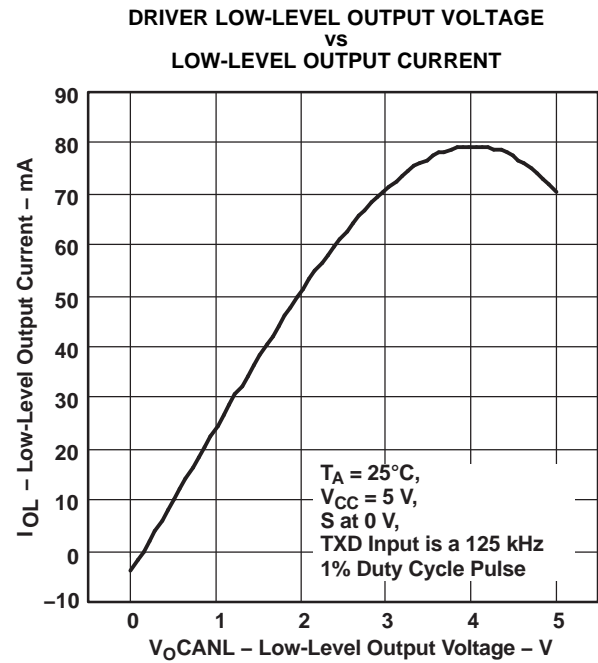

Figure 17.

TYPICAL CHARACTERISTICS (continued)

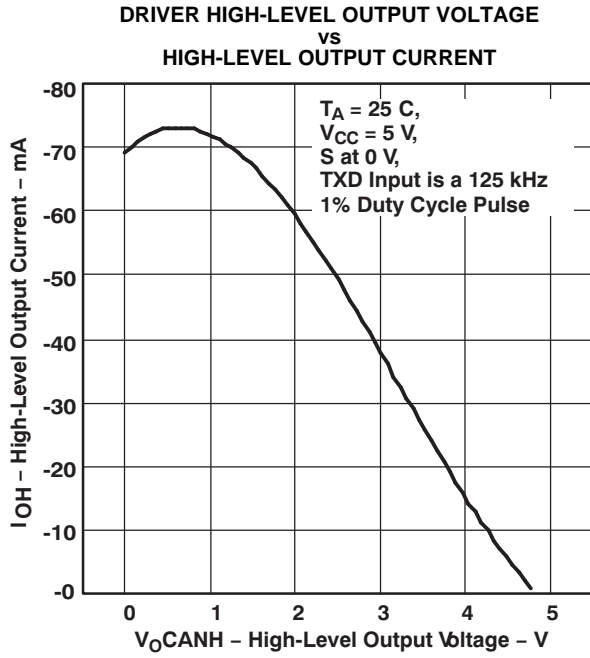

Figure 18.

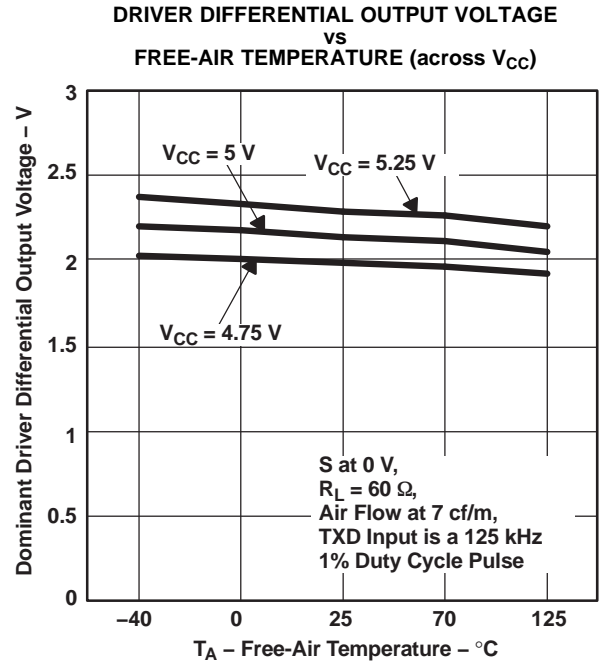

Figure 19.

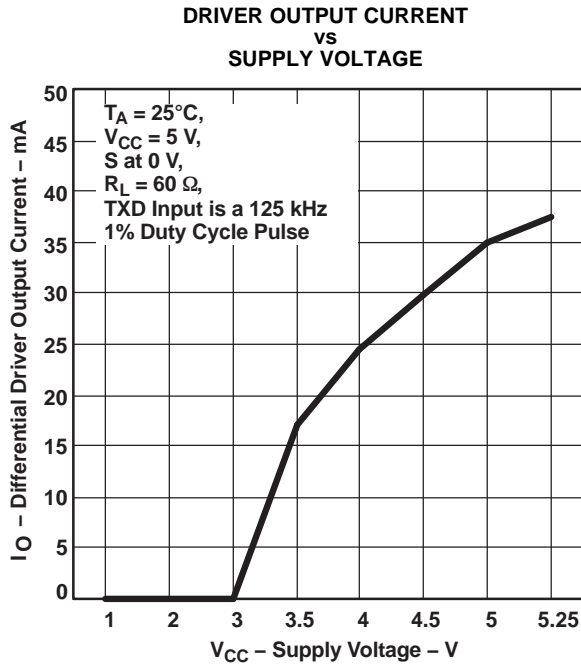

Figure 20.

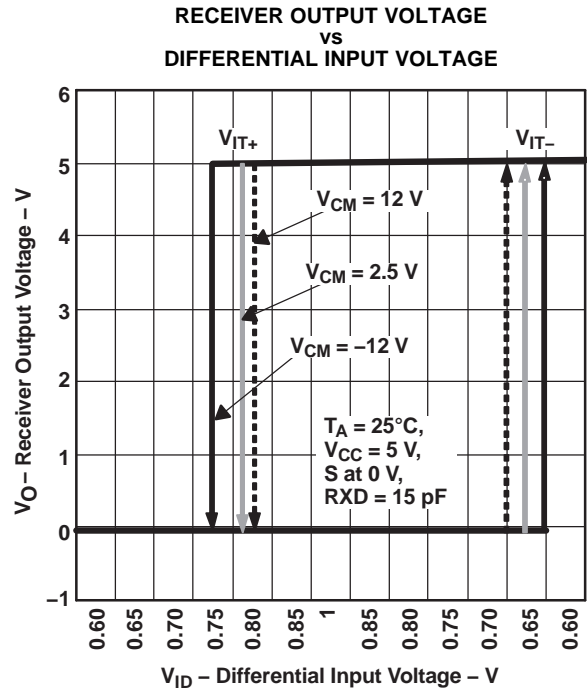

Figure 21.

TYPICAL CHARACTERISTICS (continued)

TYPICAL ELECTROMAGNETIC EMISSIONS UP TO 50 MHz (Peak Amplitude)

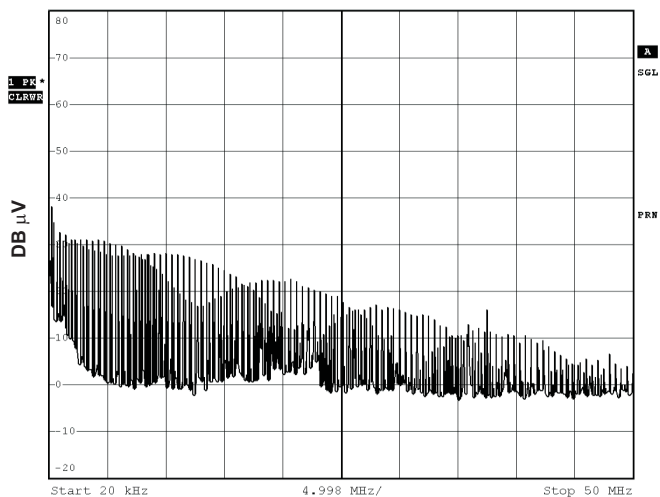

Figure 22. Frequency Spectrum of Common-Mode Emissions

TYPICAL ELECTROMAGNETIC IMMUNITY PERFORMANCE

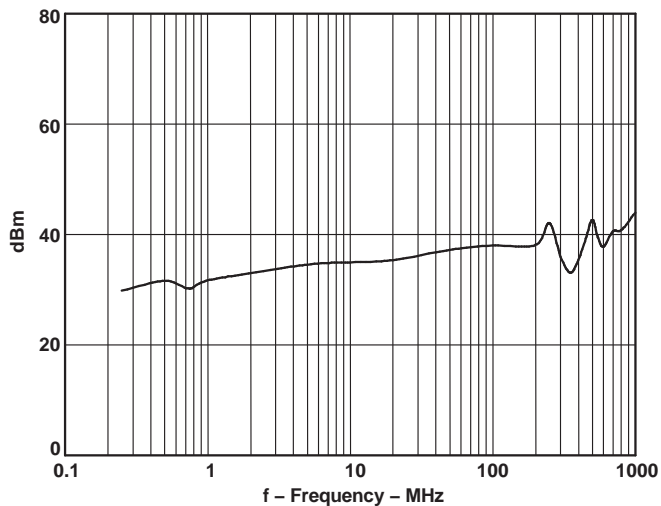

Figure 23. Direct Power Injection (DPI) Response vs Frequency

APPLICATION INFORMATION

CAN Basics

The basics of arbitration require that the receiver at the sending node designate the first bit as dominant or recessive after the initial wave of the first bit of a message travels to the most remote node on a network and back again. Typically, this “sample” is made at 75% of the bit width, and within this limitation, the maximum allowable signal distortion in a CAN network is determined by network electrical parameters.

Factors to be considered in network design include the approximately 5 ns/m propagation delay of typical twisted-pair bus cable; signal amplitude loss due to the loss mechanisms of the cable; and the number, length, and spacing of drop-lines (stubs) on a network. Under strict analysis, variations among the different oscillators in a system also need to be accounted for with adjustments in signaling rate and stub and bus length. [Table 5](#) lists the maximum signaling rates achieved with the SN65HVD1040 with several bus lengths of category 5, shielded twisted pair (CAT 5 STP) cable.

Table 5. Maximum Signaling Rates for Various Cable Lengths

Bus Length (m)	Signaling Rate (kbps)
30	1000
100	500
250	250
500	125
1000	62.5

The ISO 11898 Standard specifies a maximum bus length of 40 m and maximum stub length of 0.3 m with a maximum of 30 nodes. However, with careful design, users can have longer cables, longer stub lengths, and many more nodes to a bus. (Note: Non-standard application may come with a trade-off in signaling rate.) A large number of nodes requires a transceiver with high input impedance such as the HVD1040.

The Standard specifies the interconnect to be a single twisted-pair cable (shielded or unshielded) with 120 Ω characteristic impedance (Z_0). Resistors equal to the characteristic impedance of the line terminate both ends of the cable to prevent signal reflections. Unterminated drop-lines connect nodes to the bus and should be kept as short as possible to minimize signal reflections.

Connectors, while not specified by the standard should have as little effect as possible on standard operating parameters such as capacitive loading. Although unshielded cable is used in many applications, data transmission circuits employing CAN transceivers are usually used in applications requiring a rugged interconnection with a wide common-mode voltage range. Therefore, shielded cable is recommended in these electronically harsh environments, and when coupled with the Standard's -2 -V to 7-V common-mode range of tolerable ground noise, helps to ensure data integrity. The HVD1040 enhances the Standard's insurance of data integrity with an extended -12 V to 12 V range of common-mode operation.

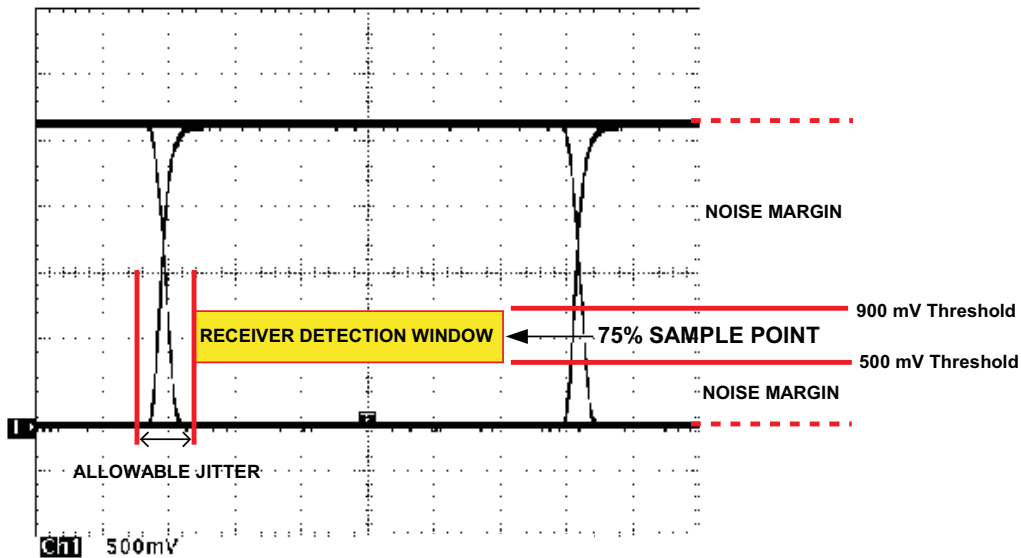

Figure 24. Typical CAN Differential Signal Eye-Pattern

An eye pattern is a useful tool for measuring overall signal quality. As displayed in Figure 25, the differential signal changes logic states in two places on the display, producing an “eye.” Instead of viewing only one logic crossing on the scope, an entire “bit” of data is brought into view. The resulting eye pattern includes all of the effects of systemic and random distortion, and displays the time during which a signal may be considered valid.

The height of the eye above or below the receiver threshold voltage level at the sampling point is the noise margin of the system. Jitter is typically measured at the differential voltage zero-crossing during the logic state transition of a signal. Note that jitter present at the receiver threshold voltage level is considered by some to be a more effective representation of the jitter at the input of a receiver.

As the sum of skew and noise increases, the eye closes and data is corrupted. Closing the width decreases the time available for accurate sampling, and lowering the height enters the 900 mV or 500 mV threshold of a receiver.

Different sources induce noise onto a signal. The more obvious noise sources are the components of a transmission circuit themselves; the signal transmitter, traces and cables, connectors, and the receiver. Beyond that, there is a termination dependency, cross-talk from clock traces and other proximity effects, V_{CC} and ground bounce, and electromagnetic interference from near-by electrical equipment.

The balanced receiver inputs of the HVD1040 mitigate most all sources of signal corruption, and when used with a quality shielded twisted-pair cable, help insure data integrity.

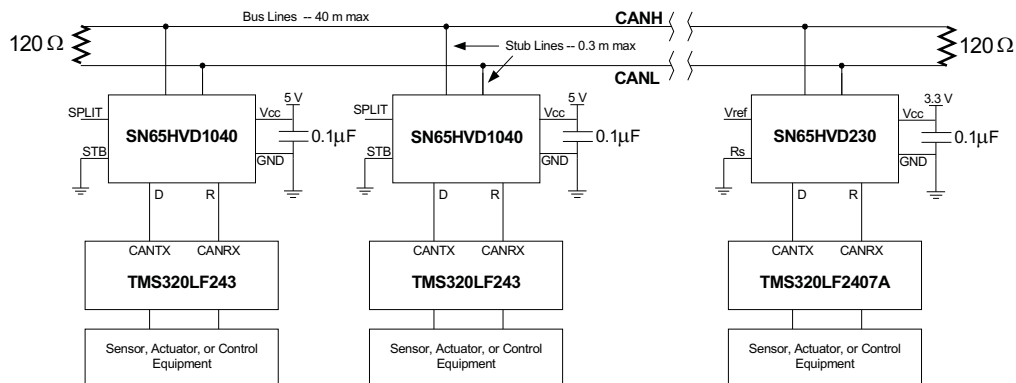

Figure 25. Typical HVD1040 Application

Thermal Shutdown

The SN65HVD1040 has a thermal shutdown that turns off the driver outputs when the junction temperature nears 190°C. This shutdown prevents catastrophic failure from bus shorts, but does not protect the circuit from possible damage. The user should strive to maintain recommended operating conditions, and not exceed absolute maximum ratings at all times. If the SN65HVD1040 is subjected to many or long durations faults that can put the device into thermal shutdown, it should be replaced.

PACKAGING INFORMATION

Orderable Device	Status ⁽¹⁾	Package Type	Package Drawing	Pins	Package Qty	Eco Plan ⁽²⁾	Lead/ Ball Finish	MSL Peak Temp ⁽³⁾	Samples (Requires Login)
SN65HVD1040D	ACTIVE	SOIC	D	8	75	Green (RoHS & no Sb/Br)	CU NIPDAU	Level-1-260C-UNLIM	Add to cart
SN65HVD1040DG4	ACTIVE	SOIC	D	8	75	Green (RoHS & no Sb/Br)	CU NIPDAU	Level-1-260C-UNLIM	Add to cart
SN65HVD1040DR	ACTIVE	SOIC	D	8	2500	Green (RoHS & no Sb/Br)	CU NIPDAU	Level-1-260C-UNLIM	Add to cart
SN65HVD1040DRG4	ACTIVE	SOIC	D	8	2500	Green (RoHS & no Sb/Br)	CU NIPDAU	Level-1-260C-UNLIM	Add to cart

⁽¹⁾ The marketing status values are defined as follows:

ACTIVE: Product device recommended for new designs.

LIFEBUY: TI has announced that the device will be discontinued, and a lifetime-buy period is in effect.

NRND: Not recommended for new designs. Device is in production to support existing customers, but TI does not recommend using this part in a new design.

PREVIEW: Device has been announced but is not in production. Samples may or may not be available.

OBSOLETE: TI has discontinued the production of the device.

⁽²⁾ Eco Plan - The planned eco-friendly classification: Pb-Free (RoHS), Pb-Free (RoHS Exempt), or Green (RoHS & no Sb/Br) - please check <http://www.ti.com/productcontent> for the latest availability information and additional product content details.

TBD: The Pb-Free/Green conversion plan has not been defined.

Pb-Free (RoHS): TI's terms "Lead-Free" or "Pb-Free" mean semiconductor products that are compatible with the current RoHS requirements for all 6 substances, including the requirement that lead not exceed 0.1% by weight in homogeneous materials. Where designed to be soldered at high temperatures, TI Pb-Free products are suitable for use in specified lead-free processes.

Pb-Free (RoHS Exempt): This component has a RoHS exemption for either 1) lead-based flip-chip solder bumps used between the die and package, or 2) lead-based die adhesive used between the die and leadframe. The component is otherwise considered Pb-Free (RoHS compatible) as defined above.

Green (RoHS & no Sb/Br): TI defines "Green" to mean Pb-Free (RoHS compatible), and free of Bromine (Br) and Antimony (Sb) based flame retardants (Br or Sb do not exceed 0.1% by weight in homogeneous material)

⁽³⁾ MSL, Peak Temp. -- The Moisture Sensitivity Level rating according to the JEDEC industry standard classifications, and peak solder temperature.

Important Information and Disclaimer: The information provided on this page represents TI's knowledge and belief as of the date that it is provided. TI bases its knowledge and belief on information provided by third parties, and makes no representation or warranty as to the accuracy of such information. Efforts are underway to better integrate information from third parties. TI has taken and continues to take reasonable steps to provide representative and accurate information but may not have conducted destructive testing or chemical analysis on incoming materials and chemicals. TI and TI suppliers consider certain information to be proprietary, and thus CAS numbers and other limited information may not be available for release.

In no event shall TI's liability arising out of such information exceed the total purchase price of the TI part(s) at issue in this document sold by TI to Customer on an annual basis.

OTHER QUALIFIED VERSIONS OF SN65HVD1040 :

- Automotive: [SN65HVD1040-Q1](#)

NOTE: Qualified Version Definitions:

- Automotive - Q100 devices qualified for high-reliability automotive applications targeting zero defects

TAPE AND REEL INFORMATION
REEL DIMENSIONS

TAPE DIMENSIONS

A0	Dimension designed to accommodate the component width
B0	Dimension designed to accommodate the component length
K0	Dimension designed to accommodate the component thickness
W	Overall width of the carrier tape
P1	Pitch between successive cavity centers

TAPE AND REEL INFORMATION

*All dimensions are nominal

Device	Package Type	Package Drawing	Pins	SPQ	Reel Diameter (mm)	Reel Width W1 (mm)	A0 (mm)	B0 (mm)	K0 (mm)	P1 (mm)	W (mm)	Pin1 Quadrant
SN65HVD1040DR	SOIC	D	8	2500	330.0	12.4	6.4	5.2	2.1	8.0	12.0	Q1

TAPE AND REEL BOX DIMENSIONS



*All dimensions are nominal

Device	Package Type	Package Drawing	Pins	SPQ	Length (mm)	Width (mm)	Height (mm)
SN65HVD1040DR	SOIC	D	8	2500	367.0	367.0	35.0

D (R-PDSO-G8)

PLASTIC SMALL OUTLINE



D (R-PDSO-G8)

PLASTIC SMALL OUTLINE



- NOTES:
- A. All linear dimensions are in millimeters.
 - B. This drawing is subject to change without notice.
 - C. Publication IPC-7351 is recommended for alternate designs.
 - D. Laser cutting apertures with trapezoidal walls and also rounding corners will offer better paste release. Customers should contact their board assembly site for stencil design recommendations. Refer to IPC-7525 for other stencil recommendations.
 - E. Customers should contact their board fabrication site for solder mask tolerances between and around signal pads.

IMPORTANT NOTICE

Texas Instruments Incorporated and its subsidiaries (TI) reserve the right to make corrections, enhancements, improvements and other changes to its semiconductor products and services per JESD46C and to discontinue any product or service per JESD48B. Buyers should obtain the latest relevant information before placing orders and should verify that such information is current and complete. All semiconductor products (also referred to herein as "components") are sold subject to TI's terms and conditions of sale supplied at the time of order acknowledgment.

TI warrants performance of its components to the specifications applicable at the time of sale, in accordance with the warranty in TI's terms and conditions of sale of semiconductor products. Testing and other quality control techniques are used to the extent TI deems necessary to support this warranty. Except where mandated by applicable law, testing of all parameters of each component is not necessarily performed.

TI assumes no liability for applications assistance or the design of Buyers' products. Buyers are responsible for their products and applications using TI components. To minimize the risks associated with Buyers' products and applications, Buyers should provide adequate design and operating safeguards.

TI does not warrant or represent that any license, either express or implied, is granted under any patent right, copyright, mask work right, or other intellectual property right relating to any combination, machine, or process in which TI components or services are used. Information published by TI regarding third-party products or services does not constitute a license to use such products or services or a warranty or endorsement thereof. Use of such information may require a license from a third party under the patents or other intellectual property of the third party, or a license from TI under the patents or other intellectual property of TI.

Reproduction of significant portions of TI information in TI data books or data sheets is permissible only if reproduction is without alteration and is accompanied by all associated warranties, conditions, limitations, and notices. TI is not responsible or liable for such altered documentation. Information of third parties may be subject to additional restrictions.

Resale of TI components or services with statements different from or beyond the parameters stated by TI for that component or service voids all express and any implied warranties for the associated TI component or service and is an unfair and deceptive business practice. TI is not responsible or liable for any such statements.

Buyer acknowledges and agrees that it is solely responsible for compliance with all legal, regulatory and safety-related requirements concerning its products, and any use of TI components in its applications, notwithstanding any applications-related information or support that may be provided by TI. Buyer represents and agrees that it has all the necessary expertise to create and implement safeguards which anticipate dangerous consequences of failures, monitor failures and their consequences, lessen the likelihood of failures that might cause harm and take appropriate remedial actions. Buyer will fully indemnify TI and its representatives against any damages arising out of the use of any TI components in safety-critical applications.

In some cases, TI components may be promoted specifically to facilitate safety-related applications. With such components, TI's goal is to help enable customers to design and create their own end-product solutions that meet applicable functional safety standards and requirements. Nonetheless, such components are subject to these terms.

No TI components are authorized for use in FDA Class III (or similar life-critical medical equipment) unless authorized officers of the parties have executed a special agreement specifically governing such use.

Only those TI components which TI has specifically designated as military grade or "enhanced plastic" are designed and intended for use in military/aerospace applications or environments. Buyer acknowledges and agrees that any military or aerospace use of TI components which have **not** been so designated is solely at the Buyer's risk, and that Buyer is solely responsible for compliance with all legal and regulatory requirements in connection with such use.

TI has specifically designated certain components which meet ISO/TS16949 requirements, mainly for automotive use. Components which have not been so designated are neither designed nor intended for automotive use; and TI will not be responsible for any failure of such components to meet such requirements.

Products

Audio	www.ti.com/audio
Amplifiers	amplifier.ti.com
Data Converters	dataconverter.ti.com
DLP® Products	www.dlp.com
DSP	dsp.ti.com
Clocks and Timers	www.ti.com/clocks
Interface	interface.ti.com
Logic	logic.ti.com
Power Mgmt	power.ti.com
Microcontrollers	microcontroller.ti.com
RFID	www.ti-rfid.com
OMAP Mobile Processors	www.ti.com/omap
Wireless Connectivity	www.ti.com/wirelessconnectivity

Applications

Automotive and Transportation	www.ti.com/automotive
Communications and Telecom	www.ti.com/communications
Computers and Peripherals	www.ti.com/computers
Consumer Electronics	www.ti.com/consumer-apps
Energy and Lighting	www.ti.com/energy
Industrial	www.ti.com/industrial
Medical	www.ti.com/medical
Security	www.ti.com/security
Space, Avionics and Defense	www.ti.com/space-avionics-defense
Video and Imaging	www.ti.com/video

TI E2E Community e2e.ti.com

AMEYA360

Components Supply Platform

Authorized Distribution Brand :



Website :

Welcome to visit www.ameya360.com

Contact Us :

➤ Address :

401 Building No.5, JiuGe Business Center, Lane 2301, Yishan Rd
Minhang District, Shanghai , China

➤ Sales :

Direct +86 (21) 6401-6692

Email amall@ameya360.com

QQ 800077892

Skype [ameyasales1](#) [ameyasales2](#)

➤ Customer Service :

Email service@ameya360.com

➤ Partnership :

Tel +86 (21) 64016692-8333

Email mkt@ameya360.com