

# Coiltronics FP1008 Family

## High frequency, high current power inductors

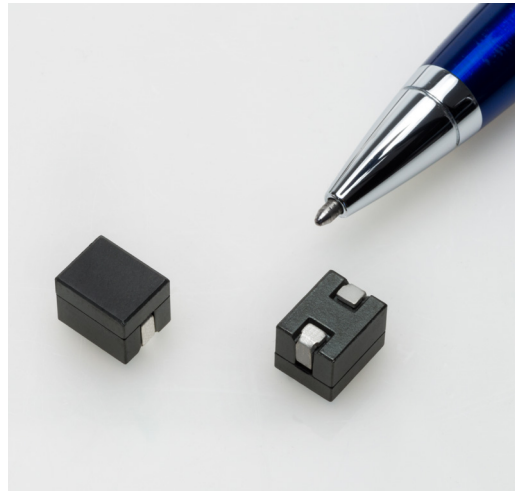

### Product description

- High current carrying capacity
- Low core loss
- Controlled DCR for sensing circuits
- Inductance range from 120nH to 180nH
- Current range from 63 to 100 Amps
- 10.8 x 8.0mm footprint surface mount package in a 8.0mm height
- Ferrite core material
- Halogen free, lead free, RoHS compliant

### Applications

- Multi-phase and Vcore regulators
- Voltage Regulator Modules (VRMs)
- Desktop and server VRMs and EVRDs
- Laptop and notebook regulators
- Data networking and storage systems
- Graphics cards and battery power systems
- Point-of-Load modules
- DCR Sensing circuits

### Environmental data

- Storage temperature range (Component): -40°C to +125°C
- Operating temperature range: -40°C to +125°C (ambient + self-temperature rise)
- Solder reflow temperature: J-STD-020D compliant



Powering Business Worldwide



The Coiltronics brand of magnetics (formerly of the Bussmann Division of Cooper Industries) is now part of Eaton's Electrical Group, Electronics Division.

**Coiltronics is now part of Eaton**  
**Same great products plus even more.**

Product specifications

Part Number <sup>9</sup>	OCL <sup>1</sup> (nH)±10%	FLL <sup>2</sup> (nH) minimum	I <sub>rms</sub> <sup>3</sup> (amps)	I <sub>sat</sub> 1 <sup>4</sup> (amps)	I <sub>sat</sub> 2 <sup>5</sup> (amps)	I <sub>sat</sub> 3 <sup>6</sup> (amps)	I <sub>sat</sub> 4 <sup>7</sup> (amps)	DCR (mΩ) @ 20°C ±5%	K-factor <sup>8</sup>
FP1008-120-R	120	82	63	100	95.0	91.0	82	0.17	366
FP1008-150-R	150	104	63	82	78.0	75.0	68	0.17	366
FP1008-180-R	180	130	63	64	60.8	58.6	53	0.17	366

- Open Circuit Inductance (OCL) Test Parameters: 100kHz, 0.1V<sub>rms</sub>, 0.0Adc @ 25°C
- Full Load Inductance (FLL) Test Parameters: 100kHz, 0.1V<sub>rms</sub>, I<sub>sat</sub>1
- I<sub>rms</sub>: DC current for an approximate temperature rise of 40°C without core loss. Derating is necessary for AC currents. PCB layout, trace thickness and width, air-flow, and proximity of other heat generating components will affect the temperature rise. It is recommended that the temperature of the part not exceed 125°C under worst case operating conditions verified in the end application.
- I<sub>sat</sub>1: Peak current for approximately 20% rolloff @ 25°C
- I<sub>sat</sub>2: Peak current for approximately 20% rolloff @ 85°C
- I<sub>sat</sub>3: Peak current for approximately 20% rolloff @ 100°C

- I<sub>sat</sub>4: Peak current for approximately 20% rolloff @ 125°C
- K-factor: Used to determine B<sub>pp</sub> for core loss (see graph).  
B<sub>pp</sub> = K \* L \* ΔI \* 10<sup>-3</sup>. B<sub>pp</sub>(Gauss), K: (K-factor from table),  
L: (Inductance in nH), ΔI (Peak-to-peak ripple current in Amps).
- Part Number Definition: FP1008-xxx-R  
- FP1008= Product code and size  
- xxx= Inductance value in nH  
- "-R" suffix = RoHS compliant

Dimensions (mm)

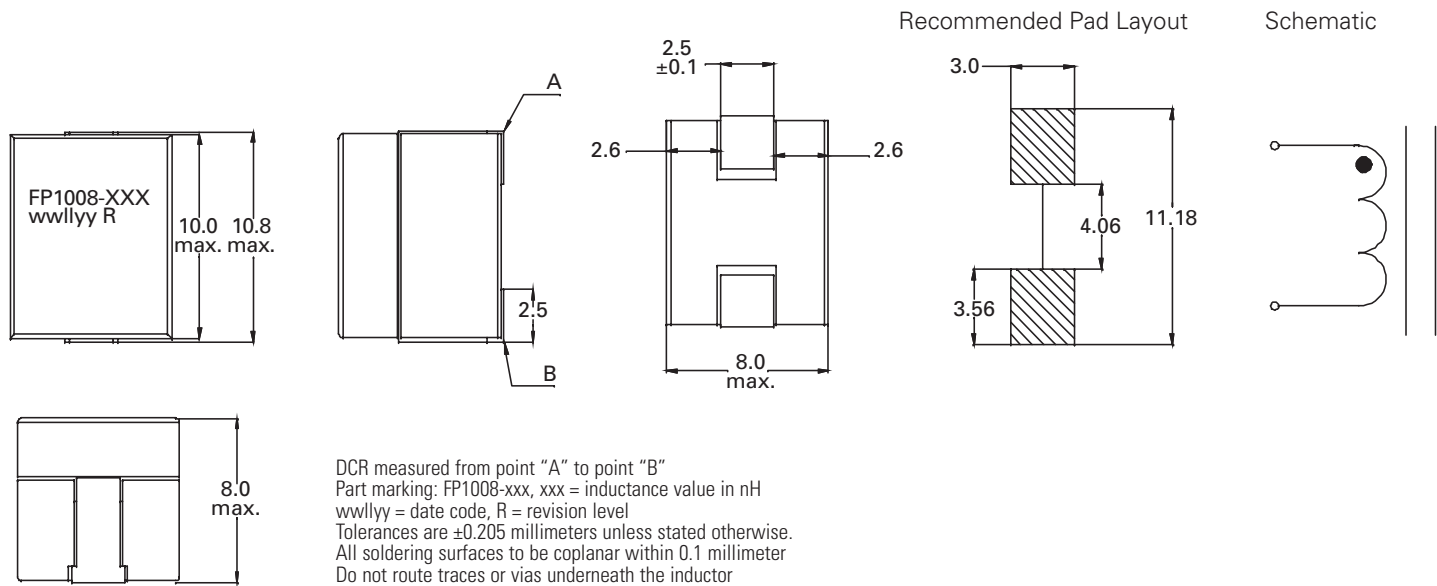

**Packaging information (mm)**

Supplied in tape-and-reel packaging, 350 parts on a 13" diameter reel.

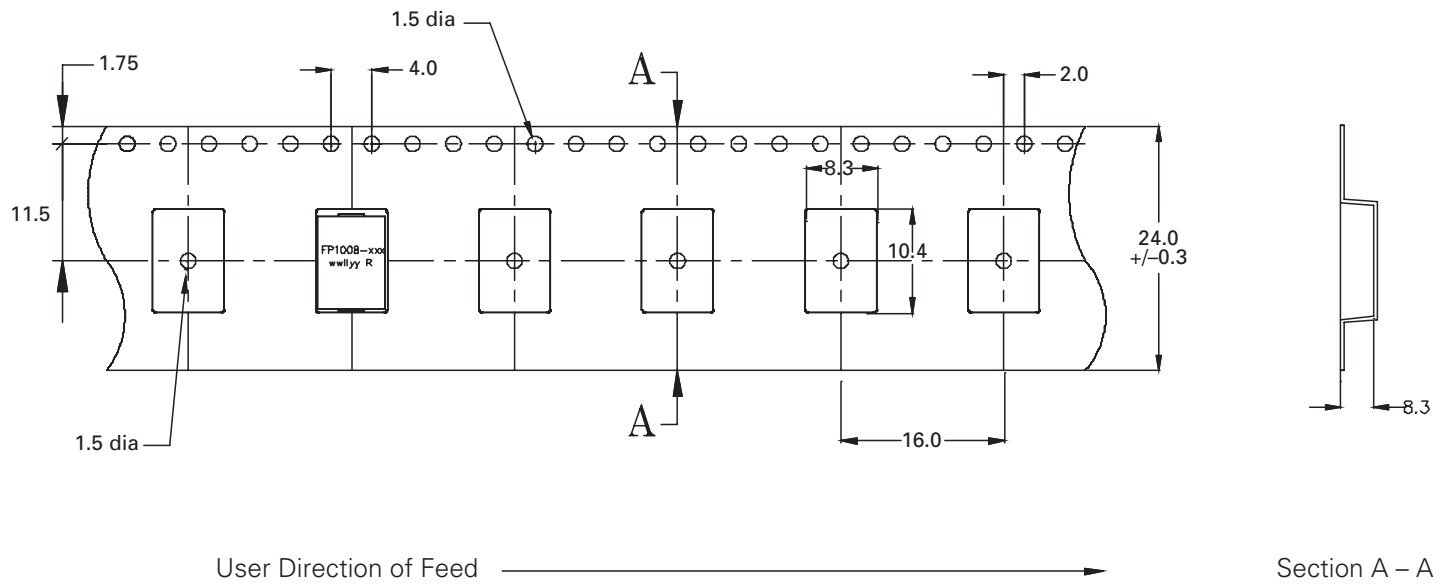

**Core loss vs. B<sub>p-p</sub>**

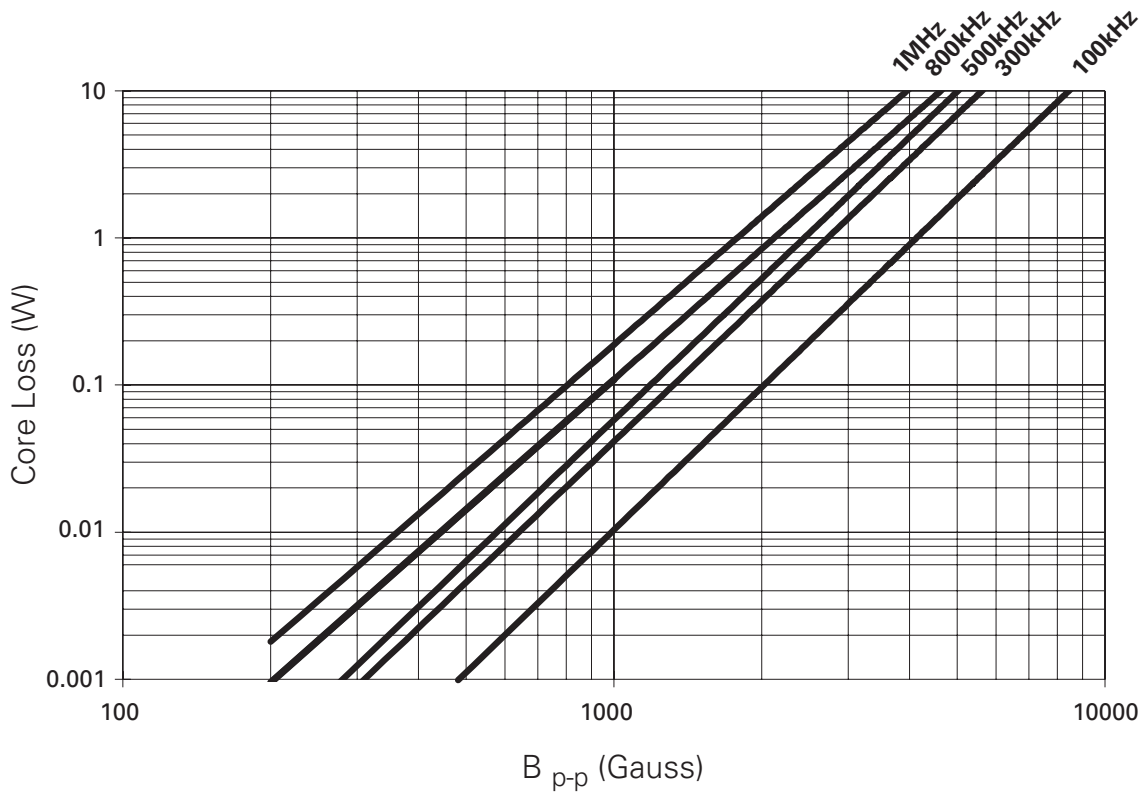

Inductance characteristics

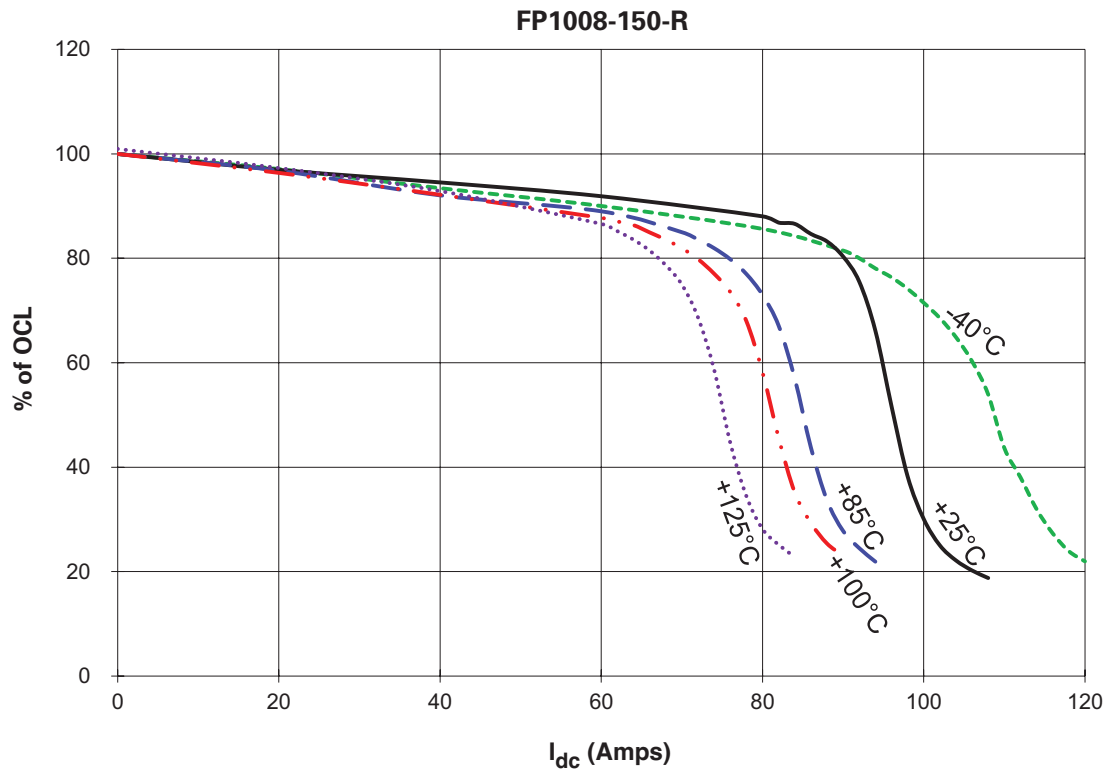
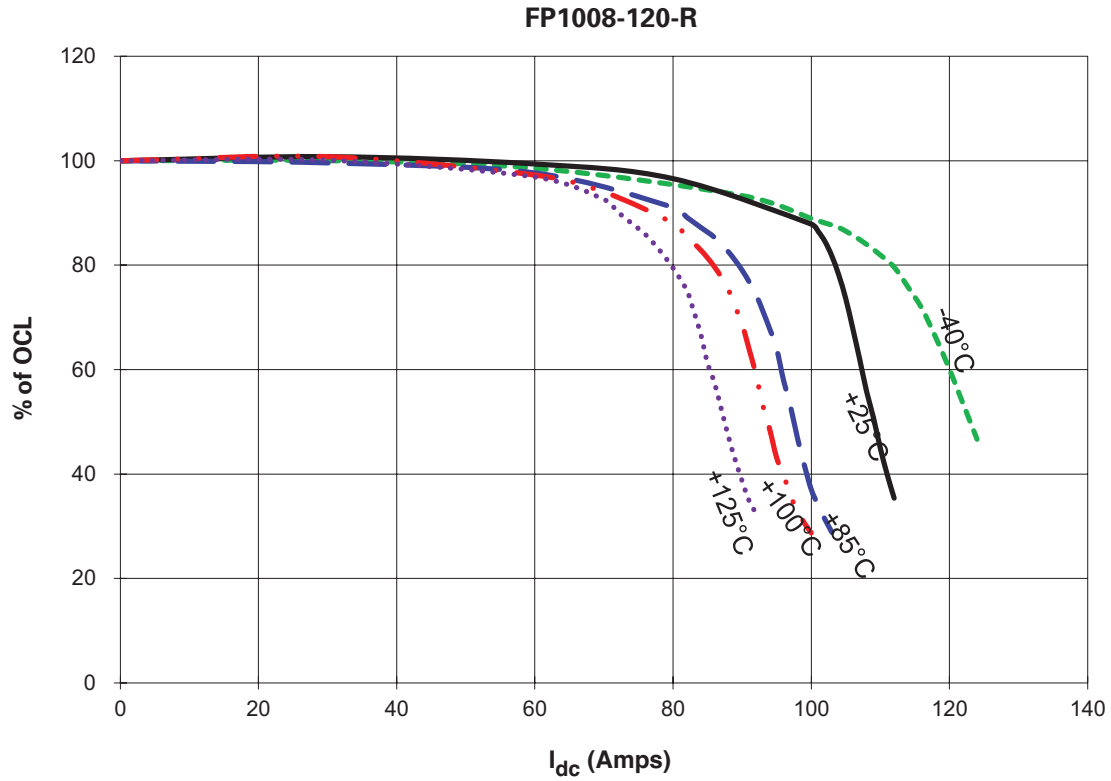

Inductance characteristics

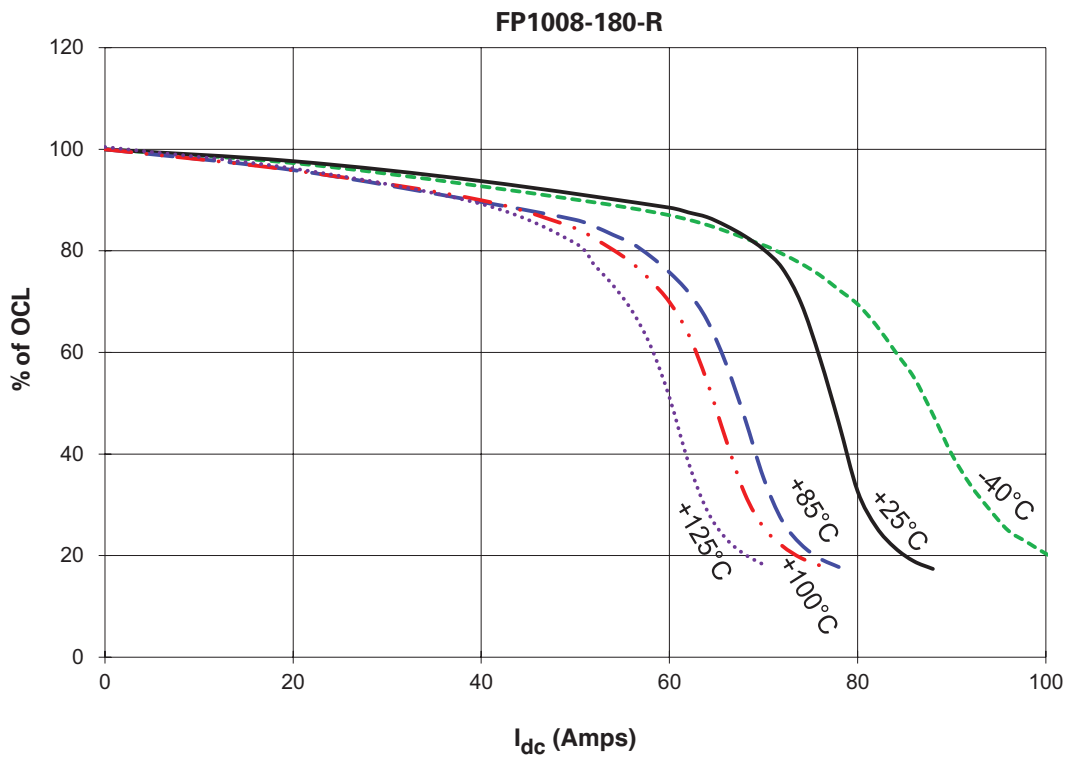

**Solder reflow profile**

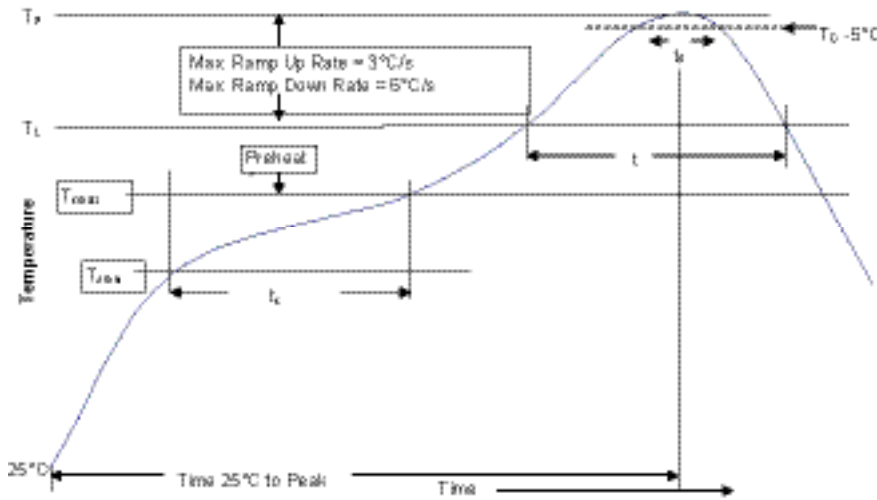

**Table 1 - Standard SnPb Solder ( $T_C$ )**

Package Thickness	Volume $\text{mm}^3$ <350	Volume $\text{mm}^3$ $\geq$ 350
<2.5mm)	235°C	220°C
$\geq$ 2.5mm	220°C	220°C

**Table 2 - Lead (Pb) Free Solder ( $T_C$ )**

Package Thickness	Volume $\text{mm}^3$ <350	Volume $\text{mm}^3$ 350 - 2000	Volume $\text{mm}^3$ >2000
<1.6mm	260°C	260°C	260°C
1.6 – 2.5mm	260°C	250°C	245°C
>2.5mm	250°C	245°C	245°C

**Reference JDEC J-STD-020D**

Profile Feature	Standard SnPb Solder	Lead (Pb) Free Solder
Preheat and Soak		
• Temperature min. ( $T_{smin}$ )	100°C	150°C
• Temperature max. ( $T_{smax}$ )	150°C	200°C
• Time ( $T_{smin}$ to $T_{smax}$ ) ( $t_s$ )	60-120 Seconds	60-120 Seconds
Average ramp up rate $T_{smax}$ to $T_p$	3°C/ Second Max.	3°C/ Second Max.
Liquidous temperature ( $T_L$ )	183°C	217°C
Time at liquidous ( $t_L$ )	60-150 Seconds	60-150 Seconds
Peak package body temperature ( $T_p$ )*	Table 1	Table 2
Time ( $t_p$ )** within 5 °C of the specified classification temperature ( $T_C$ )	20 Seconds**	30 Seconds**
Average ramp-down rate ( $T_p$ to $T_{smax}$ )	6°C/ Second Max.	6°C/ Second Max.
Time 25°C to Peak Temperature	6 Minutes Max.	8 Minutes Max.

\* Tolerance for peak profile temperature ( $T_p$ ) is defined as a supplier minimum and a user maximum.

\*\* Tolerance for time at peak profile temperature ( $t_p$ ) is defined as a supplier minimum and a user maximum.

Life Support Policy: Eaton does not authorize the use of any of its products for use in life support devices or systems without the express written approval of an officer of the Company. Life support systems are devices which support or sustain life, and whose failure to perform, when properly used in accordance with instructions for use provided in the labeling, can be reasonably expected to result in significant injury to the user.

**Eaton**  
Electronics Division  
1000 Eaton Boulevard  
Cleveland, OH 44122  
United States  
www.eaton.com/elx

© 2015 Eaton  
All Rights Reserved  
Printed in USA  
Publication No. 10155 — BU-SB14841  
March 2015

Eaton is a registered trademark.

All other trademarks are property of their respective owners.

# AMEYA360

## Components Supply Platform

Authorized Distribution Brand :



Website :

Welcome to visit [www.ameya360.com](http://www.ameya360.com)

Contact Us :

➤ Address :

401 Building No.5, JiuGe Business Center, Lane 2301, Yishan Rd  
Minhang District, Shanghai , China

➤ Sales :

Direct +86 (21) 6401-6692

Email [amall@ameya360.com](mailto:amall@ameya360.com)

QQ 800077892

Skype [ameyasales1](#) [ameyasales2](#)

➤ Customer Service :

Email [service@ameya360.com](mailto:service@ameya360.com)

➤ Partnership :

Tel +86 (21) 64016692-8333

Email [mkt@ameya360.com](mailto:mkt@ameya360.com)