

# AMMC-3041

## 18 - 42 GHz Double Balanced Mixer

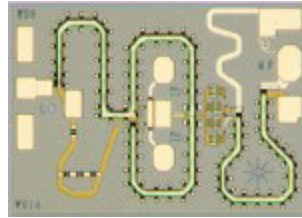

### Data Sheet



Chip Size Tolerance:  $\pm 10 \mu\text{m}$  ( $\pm 0.4$  mils)  
Chip Size Tolerance:  $10 \mu\text{m}$  ( $\pm 0.4$  mils)  
Chip Thickness:  $100 \pm 10 \mu\text{m}$  ( $4 \pm 0.4$  mils)  
Pad Dimensions:  $75 \times 75 \mu\text{m}$  ( $3 \pm 0.4$  mils)

### Description

The AMMC-3041 is a monolithic double balanced mixer designed for commercial communication systems. The AMMC-3041 mixer is fabricated using a suspended metal system to create a unique, broadside-coupled balun structure (patent pending) to achieve exceptional bandwidth. The broadband performance of the AMMC-3041 can be used to advantage by replacing conventional, narrow band mixers with a single device. For improved reliability and moisture protection, the die is passivated at the active areas.

### Features

- Wide Frequency Range:
  - RF, LO: 18 - 42 GHz
  - IF: DC - 5 GHz
- Conversion Loss: 9.5 dB
- High IIP3: +22 dBm
- High Input P<sub>-1dB</sub> : +16 dBm
- Up or Down Conversion

### Applications

- Point-to-Point Radio
- LMDS
- SATCOM

### AMMC-3041 Absolute Maximum Ratings<sup>[1]</sup>

Symbol	Parameters/Conditions	Units	Min.	Max.
T <sub>b</sub>	Operating Backside Temp.	°C	-55	+140
T <sub>stg</sub>	Storage Temp.	°C	-65	+165
T <sub>max</sub>	Maximum Assembly Temp. (60 sec. max.)	°C		+300

#### Note:

1. Operation in excess of any one of these conditions may result in permanent damage to this device.

*Note: These devices are ESD sensitive. The following precautions are strongly recommended:  
Ensure that an ESD approved carrier is used when dice are transported from one destination to another.  
Personal grounding is to be worn at all times when handling these devices.*

## AMMC-3041 RF Specifications<sup>[1]</sup>

( $Z_0 = 50 \Omega$ ,  $T_b = 25^\circ\text{C}$ ,  $IF = 2 \text{ GHz}$ , LO Input Power = +14 dBm, RF Input Power = -20 dBm, except as noted.)

Symbol	Parameters	Test Conditions	Units	Minimum	Typical	Maximum
Lc	Conversion Loss <sup>[1]</sup>	Down Conversion	dB		9.5	13
		Up Conversion			9.0	13
IIP3	Input 3 <sup>rd</sup> Order Intercept Point, Down Conversion <sup>[2]</sup>	$f_{RF} = 26 \text{ GHz}$	dBm		23	
		$f_{RF} = 38 \text{ GHz}$			22	
P <sub>-1dB</sub>	Input Power at 1 dB Conversion Loss Compression	Down Conversion	dBm		16	
		Up Conversion			5	
ISOL <sub>L-R</sub>	LO - RF Isolation	$f_{LO} = 26 \text{ GHz}$	dB		44	
		$f_{LO} = 38 \text{ GHz}$			29	

### Notes:

- 100% on-wafer RF test is done at RF frequency = 18, 22, 32, and 42 GHz.
- $\Delta f = 2 \text{ MHz}$ , RF Input Power = -10 dBm.

## Spurious Mixing Products

$f_{RF} = 31 \text{ GHz}$ , RF Input Power = -10 dBm,  
 $f_{LO} = 32 \text{ GHz}$ , LO Input Power = +14 dBm.

m x RF	n x LO				
	0	1	2	3	4
0	-	17.9	-	-	-
1	43	0	69	-	-
2	-	88	49	95	-
3	-	-	115	88	115
4	-	-	-	115	115

All values are dBc relative to the IF output power level.

# AMMC-3041 Typical Performance

$Z_o=50 \Omega$ ,  $T_b = 25^\circ\text{C}$ ,  $IF = 2 \text{ GHz}$ , LO Input Power = +14 dBm, RF Input Power = -20 dBm, except as noted.

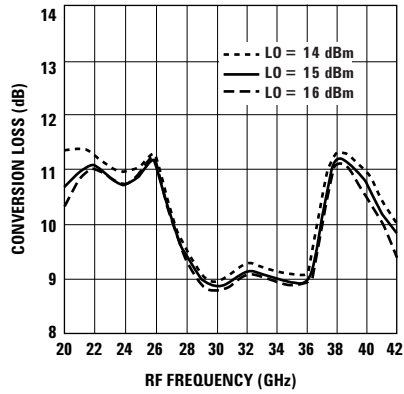

Figure 1. Conversion loss, down conversion, LO freq. = RF - IF

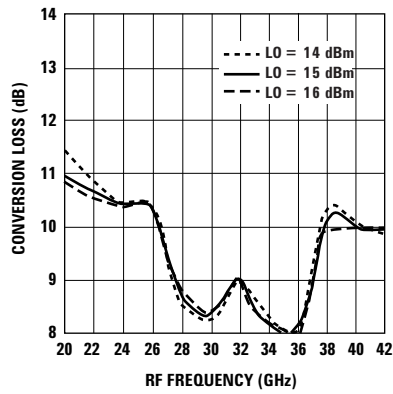

Figure 2. Conversion loss, up conversion, LO freq. = RF + IF

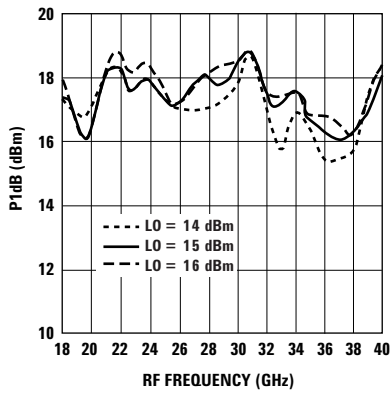

Figure 3. Output power at 1 dB conversion loss compression, down conversion, LO freq. = RF + IF

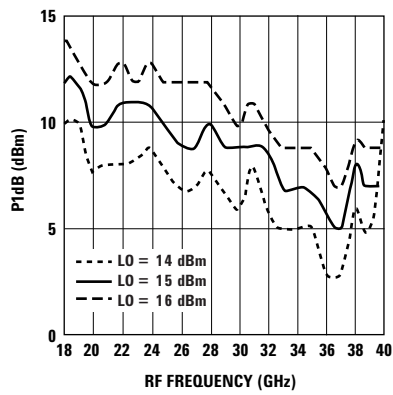

Figure 4. Output power at 1 dB conversion loss compression, up conversion, LO freq. = RF + IF

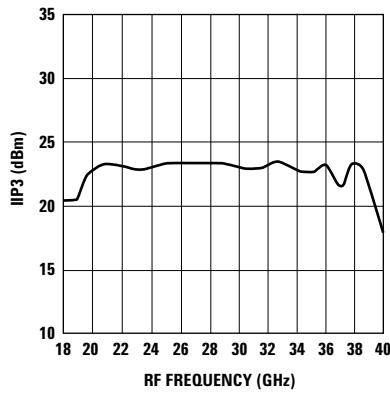

Figure 5. Input 3<sup>rd</sup> order intercept point, down conversion, LO freq. = RF + IF

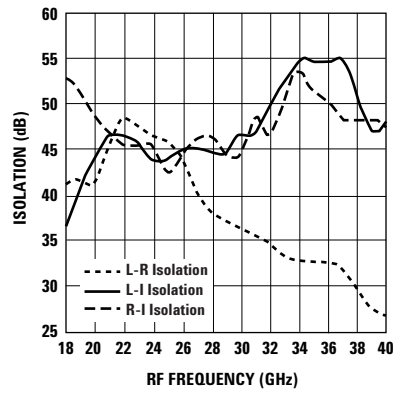

Figure 6. Isolation, down conversion, LO freq. = RF - IF

## Applications Information

Operation of the AMMC- 3041 is very straightforward. The RF, LO, and IF ports can be connected directly to 50  $\Omega$  circuits. None of the three ports should have a DC voltage applied to them. If DC voltages are present, a blocking capacitor should be used.

Some enhancement in Conversion Loss may be obtained by reflectively terminating the LO and RF signals at the IF port. This is easily done by connecting a 20- mil long bond wire from the IF output pad on the MMIC to a shunt, off-chip 0.5 pF chip capacitor as indicated in Figure 7.

For up conversion applications, the input signal is normally applied to the IF port, the local oscillator connected to the LO port, and the up-converted output signal taken from the RF port.

### Assembly Techniques

The backside of the AMMC- 3041 chip is RF ground. For microstripline applications, the chip should be attached directly to the ground plane (e.g., circuit carrier) using electrically conductive epoxy<sup>[1]</sup>.

For best performance, the topside of the MMIC should be brought up to the same height as the circuit surrounding it. This can be accomplished by mounting a gold plated metal shim (same length and width as the MMIC) under the chip, which is of the correct thickness to make the chip and adjacent circuit coplanar.

The amount of epoxy used for chip and or shim attachment should be just enough to provide a thin fillet around the bottom perimeter of the chip or shim. The ground plane should be free of any residue that may jeopardize electrical or mechanical attachment.

For use on coplanar circuits, the chip can be mounted directly on the topside ground plane of the circuit.

The location of the RF, LO, and IF bond pads is shown in Figure 8. Note that all I/O ports are in a Ground-Signal-Ground configuration. The IF port is located near the middle of the die, which allows this connection to be made from either side of the chip for maximum layout flexibility.

RF connections should be kept as short as reasonable to minimize performance degradation due to series inductance. A single bond wire is sufficient for all signal connections. However, doublebonding with 0.7 mil gold wire or the use of gold mesh<sup>[2]</sup> is recommended for best performance, especially near the high end of the frequency range.

Thermosonic wedge bonding is the preferred method for wire attachment to the bond pads. Gold mesh can be attached using a 2 mil round tracking tool and a tool force of approximately 22 grams with an ultrasonic power of roughly 55 dB for a duration of  $76 \pm 8$  mS. A guided wedge at an ultrasonic power level of 64 dB can be used for the 0.7 mil wire. The recommended wire bond stage temperature is  $150 \pm 2^\circ\text{C}$ .

Caution should be taken to not exceed the Absolute Maximum Rating for assembly temperature and time.

The chip is 100  $\mu\text{m}$  thick and should be handled with care. This MMIC has exposed air bridges on the top surface and should be handled by the edges or with a custom collet (do not pick up die with vacuum on die center.)

This MMIC is also static sensitive and ESD handling precautions should be taken.

#### Notes:

1. Ablebond 84-1 LM1 silver epoxy is recommended.
2. Buckbee-Mears Corporation, St. Paul, MN, 800-262-3824.

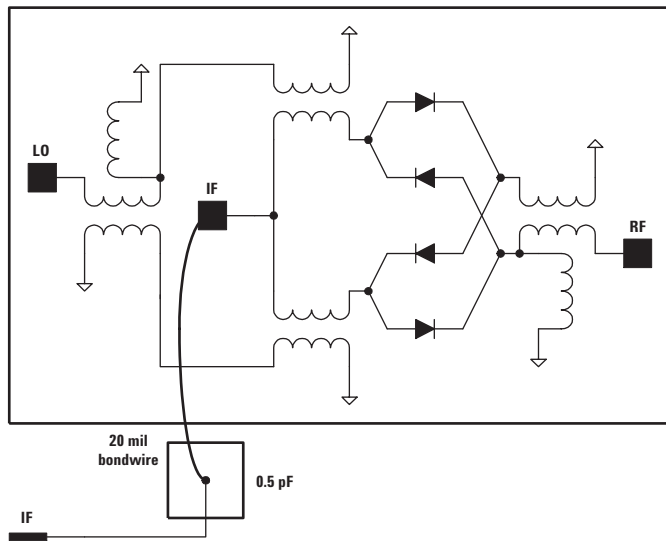

Figure 7. AMMC-3041 schematic diagram

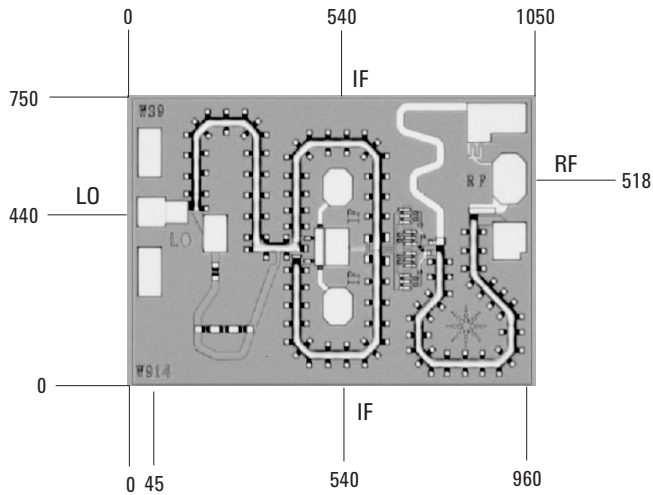

Figure 8. AMMC-3041 bonding pad locations  
Dimensions are in microns.

### Ordering Information:

AMMC-3041-W10 = 10 devices per tray  
AMMC-3041-W50 = 50 devices per tray

For product information and a complete list of distributors, please go to our website: [www.avagotech.com](http://www.avagotech.com)

Avago, Avago Technologies, and the A logo are trademarks of Avago Technologies Limited in the United States and other countries.  
Data subject to change. Copyright © 2007 Avago Technologies Limited. All rights reserved.  
5989-3933EN March 29, 2007



# AMEYA360

## Components Supply Platform

Authorized Distribution Brand :



Website :

Welcome to visit [www.ameya360.com](http://www.ameya360.com)

Contact Us :

➤ Address :

401 Building No.5, JiuGe Business Center, Lane 2301, Yishan Rd  
Minhang District, Shanghai , China

➤ Sales :

Direct +86 (21) 6401-6692

Email [amall@ameya360.com](mailto:amall@ameya360.com)

QQ 800077892

Skype [ameyasales1](#) [ameyasales2](#)

➤ Customer Service :

Email [service@ameya360.com](mailto:service@ameya360.com)

➤ Partnership :

Tel +86 (21) 64016692-8333

Email [mkt@ameya360.com](mailto:mkt@ameya360.com)