

BMR 451 Digital PoL Regulators
 Input 4.5-14 V, Output up to 40 A / 132 W

EN/LZT 146 401 R3B December 2011

© Ericsson AB

Key Features

- Small package
30.85 x 20 x 8.2 mm (1.215 x 0.787 x 0.323 in.)
- 40 A output current
- 4.5 V – 14 V input voltage range
- 0.6 V – 3.6 V output voltage range (by PMBus)
- 0.7 V – 3.3 V output voltage range (by external resistor)
- High efficiency, typ. 96,4% at half load, 5 Vin, 3.3 Vout
- 6.9 million hours MTBF
- Through hole and surface mount versions
- PMBus read and write compliant



General Characteristics

- Voltage/current/temperature monitoring
- Precision delay and ramp-up
- Voltage sequencing
- Switching frequency synchronization
- Configurable control loop
- Non-linear transient response
- Wide output voltage adjust function
- Start up into a pre-biased output
- Output short-circuit protection
- Over temperature protection
- On/Off remote control
- Output voltage sense
- ISO 9001/14001 certified supplier



Safety Approvals



Design for Environment



Meets requirements in high-temperature lead-free soldering processes.

Contents

Ordering Information	2
General Information	2
Safety Specification	3
Absolute Maximum Ratings	4
Functional Specification	5
Electrical Specification	
1.0V, 40A / 40W	6
3.3V, 40A / 132W	9
EMC Specification	12
Operating Information	12
Thermal Consideration	16
Connections	17
Typical Application Circuits	17
PMBus Interface & Commands	18
Mechanical Information	21
Soldering Information	23
Delivery Information	24
Product Qualification Specification	25

BMR 451 Digital PoL Regulators
 Input 4.5-14 V, Output up to 40 A / 132 W

EN/LZT 146 401 R3B December 2011

© Ericsson AB

Ordering Information

Product program	Output
BMR451	0.6 - 3.6 V / 40 A, 132 W

Product number and Packaging

BMR451 n ₁ n ₂ n ₃ n ₄ / n ₅ n ₆ n ₇								
Options	n ₁	n ₂	n ₃	n ₄	/	n ₅	n ₆	n ₇
Mechanical pin option	x				/			
Mechanical option		x			/			
Interface option			x	x	/			
Configuration file					/	x	x	x

Optional designation	Description
n ₁	0 = Through hole mount version (THP) 1 = Surface mount version (SMD)
n ₂	0 = Open frame
n ₃ n ₄	02 = PMBus and analog voltage adjust
n ₅ n ₆ n ₇	020 = Standard configuration xxx = Application Specific Configuration
Packaging	Antistatic injection molded tray of 30 products (5 full trays/box = 150 products)

Example: Product number BMR4511002/020 equals a surface mount, open frame, PMBus and analog voltage adjust, standard configuration variant.

For application specific configurations contact your local Ericsson Power Modules sales representative.

General Information
Reliability

The failure rate (λ) and mean time between failures (MTBF = $1/\lambda$) is calculated at max output power and an operating ambient temperature (T_A) of +40°C. Ericsson Power Modules uses Telcordia SR-332 Issue 2 Method 1 to calculate the mean steady-state failure rate and standard deviation (σ).

Telcordia SR-332 Issue 2 also provides techniques to estimate the upper confidence levels of failure rates based on the mean and standard deviation.

Mean steady-state failure rate, λ	Std. deviation, σ
146 nFailures/h	38.3 nFailures/h

MTBF (mean value) for the BMR451 series = 6.9 Mh.

MTBF at 90% confidence level = 5.1 Mh

Compatibility with RoHS requirements

The products are compatible with the relevant clauses and requirements of the RoHS directive 2002/95/EC and have a maximum concentration value of 0.1% by weight in homogeneous materials for lead, mercury, hexavalent chromium, PBB and PBDE and of 0.01% by weight in homogeneous materials for cadmium.

Exemptions in the RoHS directive utilized in Ericsson Power Modules products include:

- Lead in high melting temperature type solder (used to solder the die in semiconductor packages)
- Lead in glass of electronics components and in electronic ceramic parts (e.g. fill material in chip resistors)
- Lead as an alloying element in copper alloy containing up to 4% lead by weight (used in connection pins made of Brass)

Quality Statement

The products are designed and manufactured in an industrial environment where quality systems and methods like ISO 9000, 6 σ (sigma), and SPC are intensively in use to boost the continuous improvements strategy. Infant mortality or early failures in the products are screened out and they are subjected to an ATE-based final test. Conservative design rules, design reviews and product qualifications, plus the high competence of an engaged work force, contribute to the high quality of our products.

Warranty

Warranty period and conditions are defined in Ericsson AB's General Terms and Conditions of Sale. Ericsson AB does not make any other warranties, expressed or implied including any warranty of merchantability, effects of product configurations made by customers or fitness for a particular purpose.

© Ericsson AB 2010

The information and specifications in this technical specification is believed to be correct at the time of publication. However, no liability is accepted for inaccuracies, printing errors or for any consequences thereof. Ericsson AB reserves the right to change the contents of this technical specification at any time without prior notice.

BMR 451 Digital PoL Regulators
Input 4.5-14 V, Output up to 40 A / 132 W

EN/LZT 146 401 R3B December 2011

© Ericsson AB

Safety Specification**General information**

Ericsson Power Modules DC/DC converters and DC/DC regulators are designed in accordance with safety standards IEC/EN/UL 60950-1 *Safety of Information Technology Equipment*.

IEC/EN/UL 60950-1 contains requirements to prevent injury or damage due to the following hazards:

- Electrical shock
- Energy hazards
- Fire
- Mechanical and heat hazards
- Radiation hazards
- Chemical hazards

On-board DC/DC converters and DC/DC regulators are defined as component power supplies. As components they cannot fully comply with the provisions of any safety requirements without "Conditions of Acceptability". Clearance between conductors and between conductive parts of the component power supply and conductors on the board in the final product must meet the applicable safety requirements. Certain conditions of acceptability apply for component power supplies with limited stand-off (see Mechanical Information for further information). It is the responsibility of the installer to ensure that the final product housing these components complies with the requirements of all applicable safety standards and regulations for the final product.

Component power supplies for general use should comply with the requirements in IEC 60950-1, EN 60950-1 and UL 60950-1 *Safety of Information Technology Equipment*. There are other more product related standards, e.g. IEEE 802.3 *CSMA/CD (Ethernet) Access Method*, and ETS-300132-2 *Power supply interface at the input to telecommunications equipment, operated by direct current (dc)*, but all of these standards are based on IEC/EN/UL 60950-1 with regards to safety.

Ericsson Power Modules DC/DC converters and DC/DC regulators are UL 60950-1 recognized and certified in accordance with EN 60950-1.

The flammability rating for all construction parts of the products meet requirements for V-0 class material according to IEC 60695-11-10, *Fire hazard testing, test flames* – 50 W horizontal and vertical flame test methods.

The products should be installed in the end-use equipment, in accordance with the requirements of the ultimate application. Normally the output of the DC/DC converter is considered as SELV (Safety Extra Low Voltage) and the input source must be isolated by minimum Double or Reinforced Insulation from the primary circuit (AC mains) in accordance with IEC/EN/UL 60950-1.

Isolated DC/DC converters

It is recommended that a slow blow fuse is to be used at the input of each DC/DC converter. If an input filter is used in the circuit the fuse should be placed in front of the input filter.

In the rare event of a component problem that imposes a short circuit on the input source, this fuse will provide the following functions:

- Isolate the fault from the input power source so as not to affect the operation of other parts of the system.
- Protect the distribution wiring from excessive current and power loss thus preventing hazardous overheating.

The galvanic isolation is verified in an electric strength test. The test voltage (V_{iso}) between input and output is 1500 Vdc or 2250 Vdc (refer to product specification).

24 V DC systems

The input voltage to the DC/DC converter is SELV (Safety Extra Low Voltage) and the output remains SELV under normal and abnormal operating conditions.

48 and 60 V DC systems

If the input voltage to the DC/DC converter is 75 Vdc or less, then the output remains SELV (Safety Extra Low Voltage) under normal and abnormal operating conditions.

Single fault testing in the input power supply circuit should be performed with the DC/DC converter connected to demonstrate that the input voltage does not exceed 75 Vdc.

If the input power source circuit is a DC power system, the source may be treated as a TNV-2 circuit and testing has demonstrated compliance with SELV limits in accordance with IEC/EN/UL60950-1.

Non-isolated DC/DC regulators

The input voltage to the DC/DC regulator is SELV (Safety Extra Low Voltage) and the output remains SELV under normal and abnormal operating conditions.

BMR 451 Digital PoL Regulators
 Input 4.5-14 V, Output up to 40 A / 132 W

EN/LZT 146 401 R3B December 2011

© Ericsson AB

Absolute Maximum Ratings

Characteristics		min	typ	max	Unit
T _{P1}	Operating temperature (see Thermal Consideration section)	-40		120	°C
T _S	Storage temperature	-40		125	°C
V _I	Input voltage (See Operating Information Section for input and output voltage relations)	-0.3		16	V
V _O	Output voltage	0.6		3.6	V
P _O	Output power			132	W
Logic I/O voltage	CTRL, SA(0,1), SALERT, SCL, SDA, FLEX	-0.3		6.5	V
Ground voltage differential	DGND, -S, GND	-0.3		0.3	V
Analog pin voltage	VOUT, +S	-0.3		6.5	V

Stress in excess of Absolute Maximum Ratings may cause permanent damage. Absolute Maximum Ratings, sometimes referred to as no destruction limits, are normally tested with one parameter at a time exceeding the limits of Output data or Electrical Characteristics. If exposed to stress above these limits, function and performance may degrade in an unspecified manner.

Fundamental Circuit Diagram

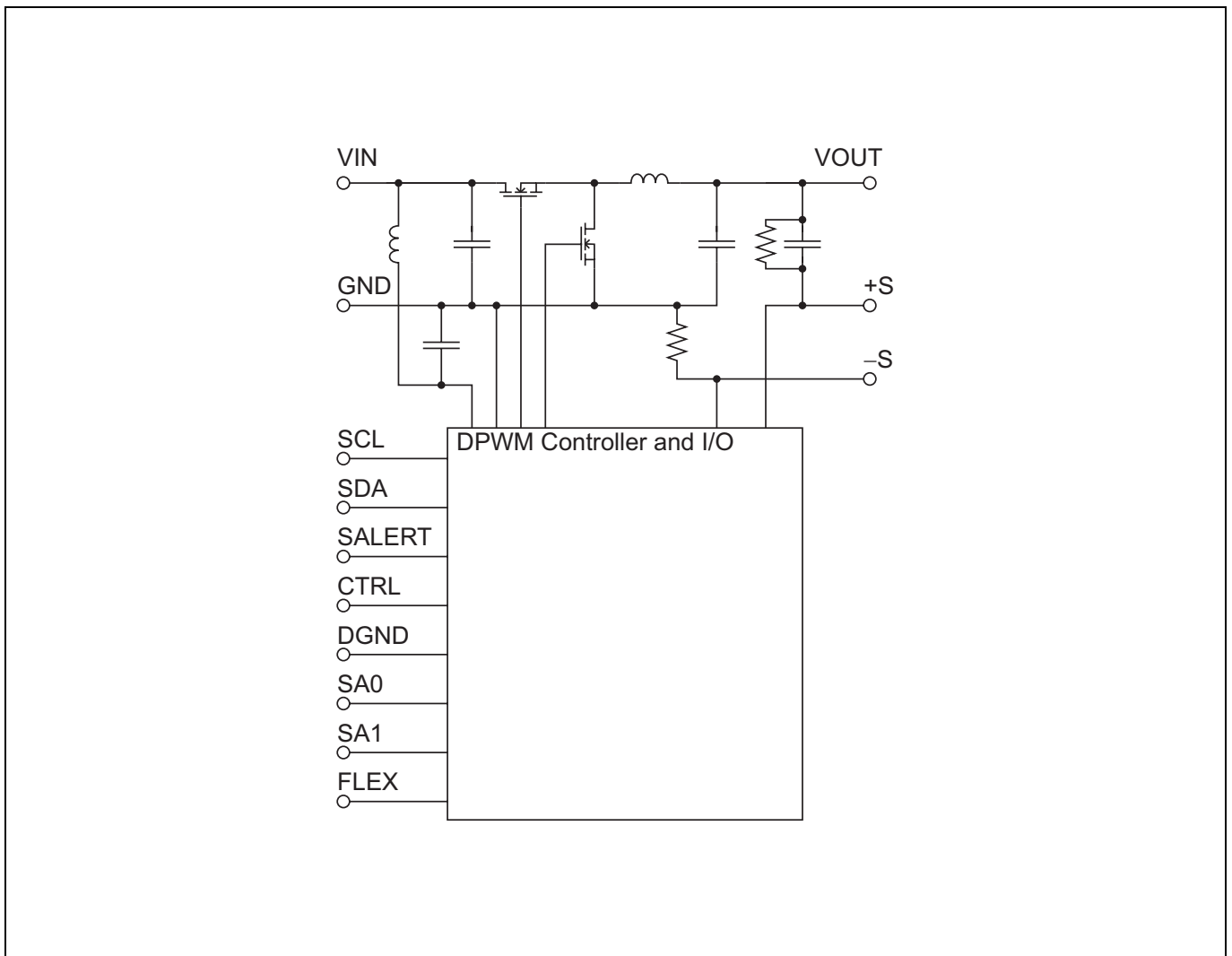

BMR 451 Digital PoL Regulators
 Input 4.5-14 V, Output up to 40 A / 132 W

EN/LZT 146 401 R3B December 2011

© Ericsson AB

Functional Specification
 $T_{P1} = -40$ to $+85^{\circ}\text{C}$, $V_I = 4.5$ to 14 V

 Typical values given at: $T_{P1} = +25^{\circ}\text{C}$, $V_I = 12$ V, max I_O , unless otherwise specified under Conditions

Configuration File: 190 10-CDA 102 900/020

Characteristics		Conditions	min	typ	max	Unit
SMBus monitoring						
VIN_READ, 0x88h	Accuracy vs. V_I		-3		3	%
VOUT_READ, 0x8Bh	Accuracy vs. V_O		-1		1	%
IOUT_READ, 0x8Ch	Accuracy vs. I_O		-20		20	%
General Electrical Characteristics						
f_s Switching frequency		Factory default		320		kHz
C_{ISMBus} Internal capacitance		SMBus signals, SDA, SCL		10		pF
C_I Internal input capacitance				140		μF
Fault Protection Characteristics						
Input Under Voltage Lockout, UVLO	UVLO Threshold			4.0		V
	Set point accuracy		-100		100	mV
	Hysteresis	Factory default		0.4		V
	Delay				2.5	μs
(Output voltage) Over/Under Voltage Protection, OVP/UVF	UVP threshold	Factory default		85		% V_{OUT}
	OVP threshold	Factory default		115		% V_{OUT}
	OVP/UVF fault response time	Factory default		25		μs
Over Current Protection, OCP	Set point accuracy	I_O	-20		+20	%
	OCP threshold	Factory default		50		A
	OCP protection delay	Factory default		45		μs
Over Temperature Protection, OTP at T_{P1}	OTP threshold	Factory default		120		$^{\circ}\text{C}$
	OTP hysteresis	Factory default		15		
Logic Input/Output Characteristics						
Logic input low threshold (V_{IL})		CTRL, SCL, SDA, FLEX			0.8	V
Logic input high threshold (V_{IH})			2.0			V
Logic output low (V_{OL})		SALERT, SCL, SDA, FLEX $I_{OL} \leq 4$ mA			0.4	V
Logic output high (V_{OH})		SALERT, SCL, SDA, FLEX $I_{OL} \geq -2$ mA	2.25			V
Setup time, SMBus (t_{set})		See Note 1	300			ns
Hold time, SMBus (t_{hold})		See Note 1	250			ns

Note 1: See operation information section for I2C/SMBus Setup and Hold Times – Definitions

BMR 451 Digital PoL Regulators
 Input 4.5-14 V, Output up to 40 A / 132 W

EN/LZT 146 401 R3B December 2011

© Ericsson AB

1.0 V, 40 A/40 W Electrical Specification
BMR 451 0002/020
 $T_{P1} = -40$ to $+85^{\circ}\text{C}$, $V_I = 4.5$ to 14 V. Configuration: CDA 102 900/020, $R_{SET} = 19.6$ k Ω .

 Typical values given at: $T_{P1} = +25^{\circ}\text{C}$, $V_I = 12.0$ V, max I_O , unless otherwise specified under Conditions.

 Additional $C_I = 470$ μF . See Operating Information section for selection of capacitor types.

Sense pins are connected to the output pins.

Characteristics		Conditions	min	typ	max	Unit
V_I	Input voltage range		4.5		14	V
V_{loff}	Turn-off input voltage	Decreasing input voltage		4.0		V
V_{lon}	Turn-on input voltage	Increasing input voltage		4.4		V
P_O	Output power				40	W
η	Efficiency	50 % of max I_O		89.1		%
		max I_O		86.5		
P_d	Power dissipation			6.2		W
P_{li}	Input idling power	$I_O = 0.01$ A		0.9		W
P_{RC}	Input standby power	Turned off with CTRL, monitoring enabled, see Note 3		145		mW
		Low power mode, monitoring disabled, see Note 3		50		mW
I_S	Static input current			3.9		A
V_{oi}	Output voltage initial setting and accuracy		0.990	1.000	1.010	V
V_O	Output voltage tolerance band	0.05 - 100 % of max I_O	0.985		1.015	V
	Idling voltage	$I_O = 0.01$ A		1.000		V
	Line regulation			4		mV
	Load regulation	0.05 - 100 % of max I_O		3		mV
V_{tr1}	Load transient voltage deviation	Load step 25-75-25 % of max I_O , $di/dt = 2.5$ A/ μs with default configuration and $C_O = 10$ mF. See Note 1		-35/+40		mV
t_{tr1}	Load transient recovery time			200		μs
C_O	Recommended external capacitance	See Note 1	680		100 000	μF
t_r	Ramp-up time (from 10-90 % of V_{oi})	0.05 - 100 % of max I_O		10		ms
t_s	Start-up time (from V_I connection to 90 % of V_{oi})			37		ms
t_f	V_O shut-down fall time (from V_I off to 10 % of V_O)				1	
		$I_O = 2$ A		50		ms
t_{CTRL}	CTRL start-up time			20		ms
	CTRL shut-down fall time (From CTRL off to 10 % of V_O)			7		ms
		$I_O = 2$ A		17		ms
I_O	Output current		0.01		40	A
I_{lim}	Current limit threshold		41	48		A
I_{sc}	Short circuit current			50		A
V_{Oac}	Output ripple & noise	See Note 2		20		mVp-p

Note 1: See Operating Information section for External Decoupling Capacitors.

Note 2: See Operating Information section for Output Ripple and Noise.

Note 3: Configurable via PMBus, please contact your local Ericsson Power Modules representative for appropriate SW tools to down-load new configurations.

BMR 451 Digital PoL Regulators
 Input 4.5-14 V, Output up to 40 A / 132 W

EN/LZT 146 401 R3B December 2011

© Ericsson AB

1.0 V, 40 A/40 W Typical Characteristics

BMR 451 0002/020

Efficiency

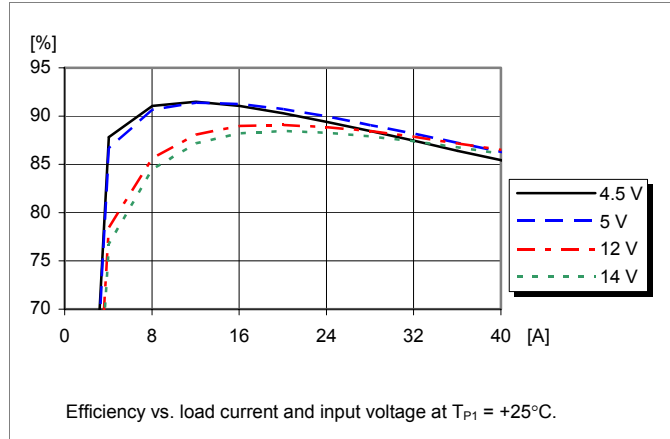

Power Dissipation

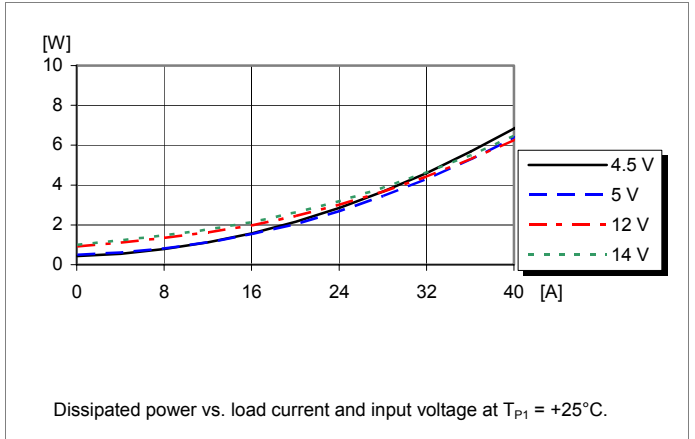

Output Current Derating

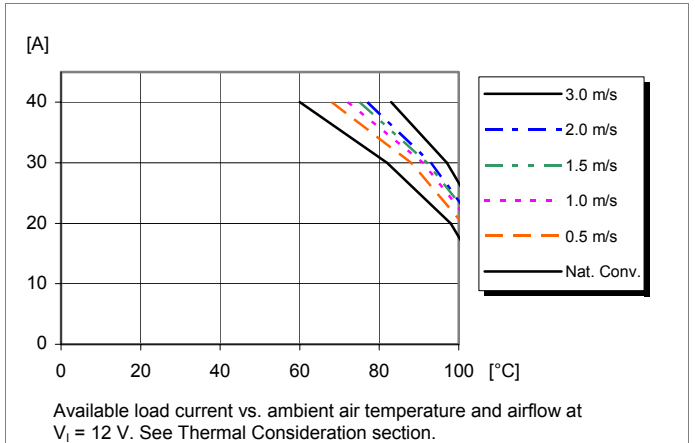
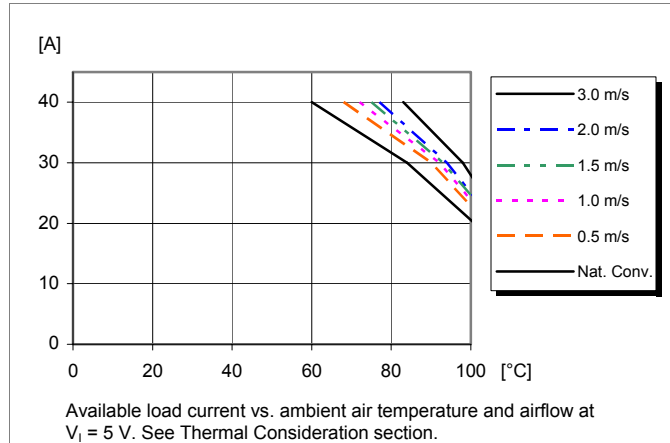

Output Characteristics

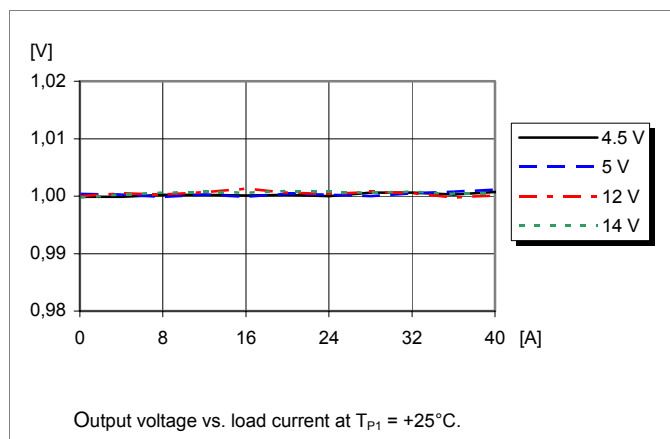

Current Limit Characteristics

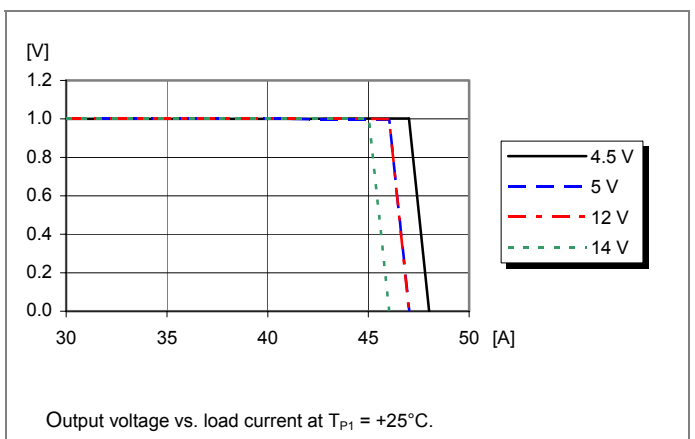

BMR 451 Digital PoL Regulators
 Input 4.5-14 V, Output up to 40 A / 132 W

EN/LZT 146 401 R3B December 2011

© Ericsson AB

1.0 V, 40 A/40 W Typical Characteristics

BMR 451 0002/020

Start-up

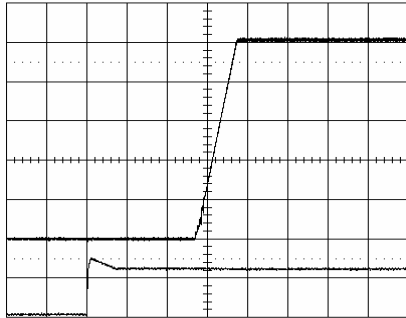

Start-up enabled by connecting V_I at:
 $T_{P1} = +25^\circ\text{C}$, $V_I = 12\text{ V}$,
 $I_O = 40\text{ A}$ resistive load and 10 mF.

Top trace: output voltage (0.2 V/div.).
 Bottom trace: input voltage (10 V/div.).
 Time scale: (10 ms/div.).

Shut-down

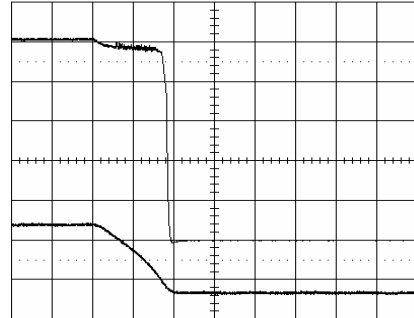

Shut-down enabled by disconnecting V_I at:
 $T_{P1} = +25^\circ\text{C}$, $V_I = 12\text{ V}$,
 $I_O = 40\text{ A}$ resistive load.

Top trace: output voltage (0.2 V/div.).
 Bottom trace: input voltage (5 V/div.).
 Time scale: (0.5 ms/div.).

Output Ripple & Noise

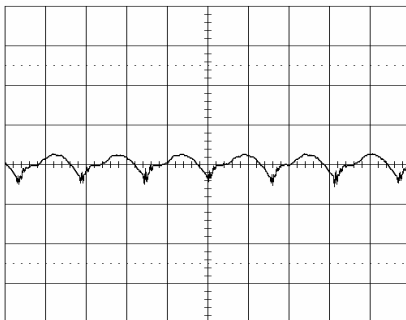

Output voltage ripple at:
 $T_{P1} = +25^\circ\text{C}$, $V_I = 12\text{ V}$,
 $I_O = 40\text{ A}$ resistive load.

Trace: output voltage (20 mV/div.).
 Time scale: (2 μs /div.).

Output Load Transient Response

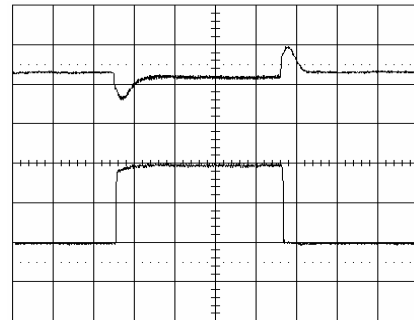

Output voltage response to load current
 step-change (10-30-10 A) at:
 $T_{P1} = +25^\circ\text{C}$, $V_I = 12\text{ V}$, $C_O = 10\text{ mF}$.

Top trace: output voltage (50 mV/div.).
 Bottom trace: load current (10 A/div.).
 Time scale: (0.5 ms/div.).

BMR 451 Digital PoL Regulators
 Input 4.5-14 V, Output up to 40 A / 132 W

EN/LZT 146 401 R3B December 2011

© Ericsson AB

3.3 V, 40 A/132 W Electrical Specification
BMR 451 0002/020
 $T_{P1} = -40$ to $+85^{\circ}\text{C}$, $V_I = 4.5$ to 14 V. Configuration: CDA 102 900/020, $R_{SET} = 1.21$ k Ω .

 Typical values given at: $T_{P1} = +25^{\circ}\text{C}$, $V_I = 12$ V, max I_O , unless otherwise specified under Conditions.

 Additional $C_I = 470$ μF . See Operating Information section for selection of capacitor types.

Sense pins are connected to the output pins.

Characteristics		Conditions	min	typ	max	Unit
V_I	Input voltage range		4.5		14	V
V_{loff}	Turn-off input voltage	Decreasing input voltage		4.0		V
V_{lon}	Turn-on input voltage	Increasing input voltage		4.4		V
P_O	Output power				132	W
η	Efficiency	50 % of max I_O		94.7		%
		max I_O		94.1		
P_d	Power dissipation			8.2		W
P_{li}	Input idling power	$I_O = 0.01$ A		2		W
P_{RC}	Input standby power	Turned off with CTRL, monitoring enabled, see Note 3		145		mW
		Low power mode, monitoring disabled, see Note 3		50		mW
I_S	Static input current			6		A
V_{Oi}	Output voltage initial setting and accuracy		3.285	3.300	3.315	V
V_O	Output voltage tolerance band	0.05 - 100 % of max I_O	3.250		3.350	V
	Idling voltage	$I_O = 0.01$ A		3.300		V
	Line regulation			4		mV
	Load regulation	0.05 - 100 % of max I_O		3		mV
V_{tr1}	Load transient voltage deviation	Load step 25-75-25 % of max I_O , $di/dt = 2.5$ A/ μs with default configuration and $C_O = 4$ mF.		-100/+180		mV
t_{tr1}	Load transient recovery time	See Note 1		100		μs
C_O	Recommended external capacitance	See Note 1	680		100 000	μF
t_r	Ramp-up time (from 10-90 % of V_{Oi})	0.05 - 100 % of max I_O		10		ms
t_s	Start-up time (from V_I connection to 90 % of V_{Oi})			37		ms
t_f	V_O shut-down fall time. (From V_I off to 10 % of V_O)			200		μs
		$I_O = 0.4$ A		25		ms
t_{CTRL}	CTRL start-up time			20		ms
	CTRL shut-down fall time (From CTRL off to 10 % of V_O)			10		ms
		$I_O = 0.4$ A		25		ms
I_O	Output current		0.01		40	A
I_{lim}	Current limit threshold		41	48		A
I_{sc}	Short circuit current			50		A
V_{Oac}	Output ripple & noise	See Note 2		40		mVp-p

Note 1: See Operating Information section for External Decoupling Capacitors.

Note 2: See Operating Information section for Output Ripple and Noise.

Note 3: Configurable via PMBus, please contact your local Ericsson Power Modules representative for appropriate SW tools to down-load new configurations.

BMR 451 Digital PoL Regulators
 Input 4.5-14 V, Output up to 40 A / 132 W

EN/LZT 146 401 R3B December 2011

© Ericsson AB

3.3V, 40 A/132 W Typical Characteristics

BMR 451 0002/020

Efficiency

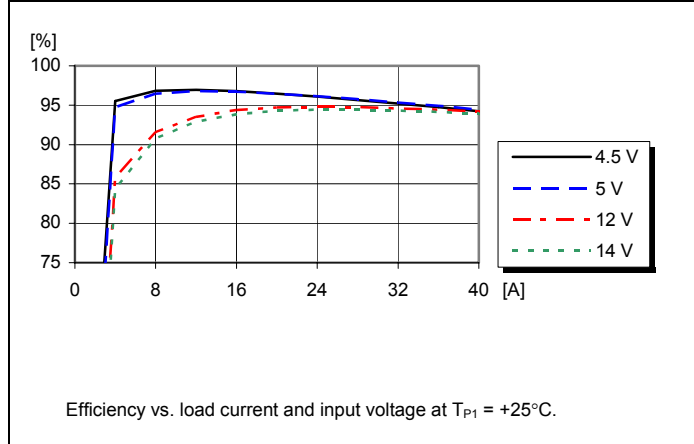

Power Dissipation

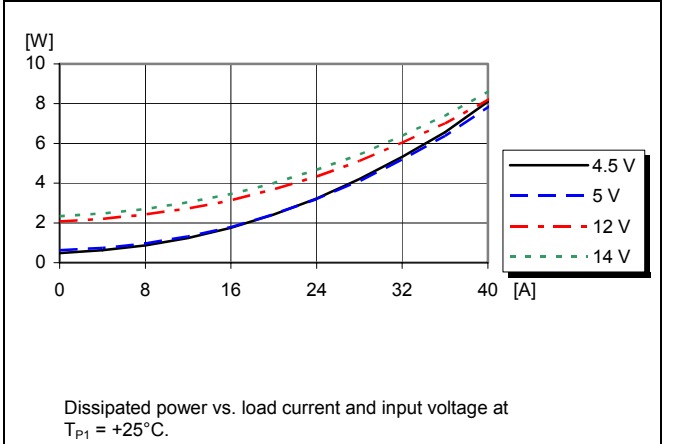

Output Current Derating

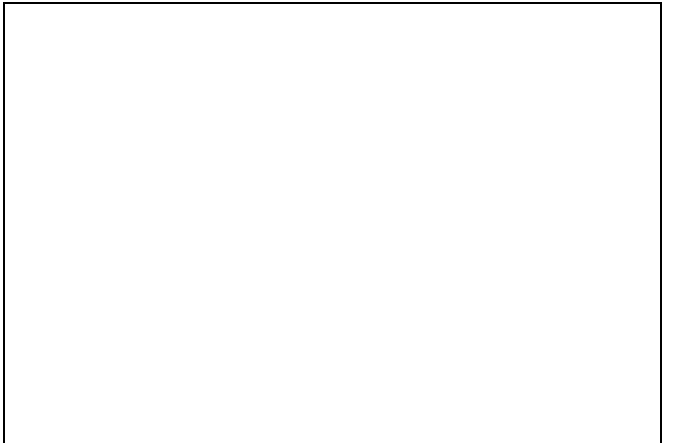
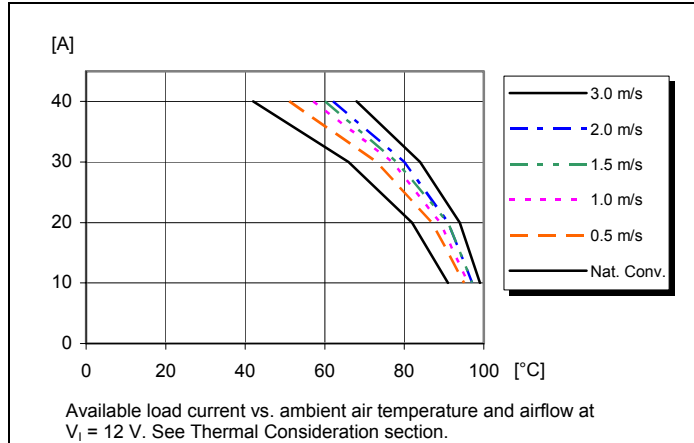

Output Characteristics

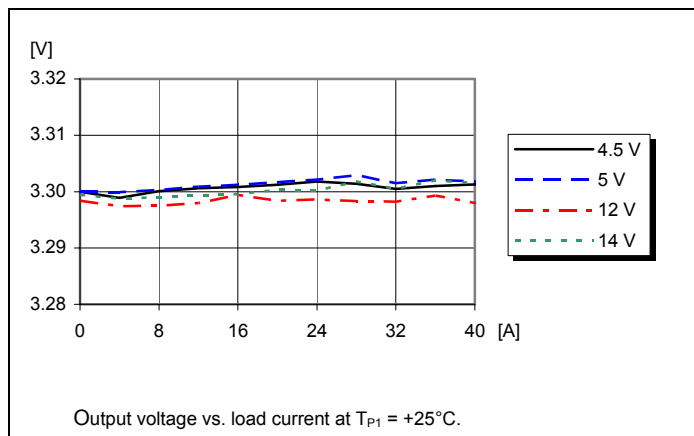

Current Limit Characteristics

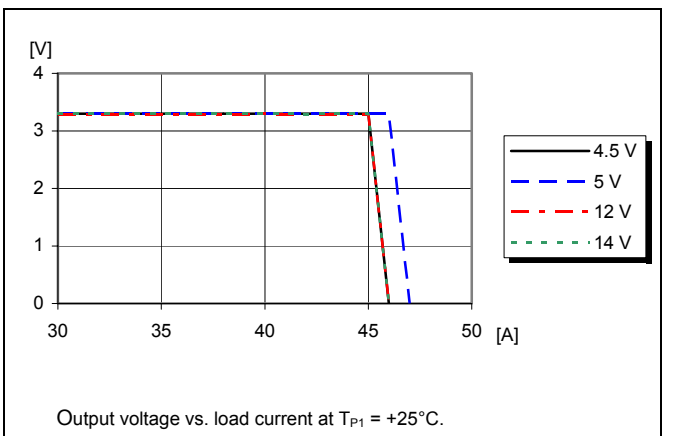

BMR 451 Digital PoL Regulators
 Input 4.5-14 V, Output up to 40 A / 132 W

EN/LZT 146 401 R3B December 2011

© Ericsson AB

3.3 V, 40 A/132 W Typical Characteristics

BMR 451 0002/020

Start-up

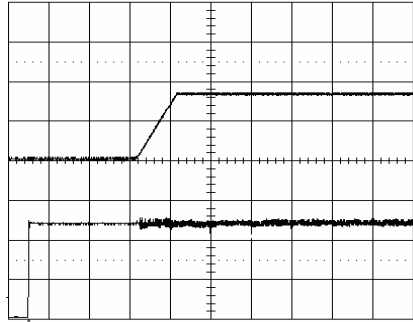

Start-up enabled by connecting V_I at:
 $T_{P1} = +25^\circ\text{C}$, $V_I = 12\text{ V}$,
 $I_O = 40\text{ A}$ resistive load and 4.4 mF.

Top trace: output voltage (2 V/div.).
 Bottom trace: input voltage (5 V/div.).
 Time scale: (10 ms/div.).

Shut-down

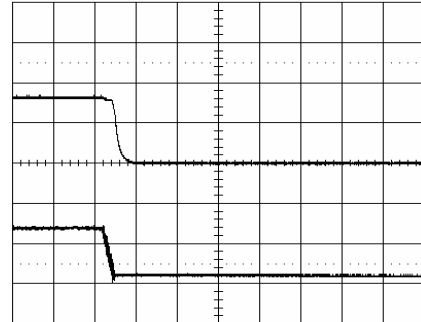

Shut-down enabled by disconnecting V_I at:
 $T_{P1} = +25^\circ\text{C}$, $V_I = 12\text{ V}$,
 $I_O = 40\text{ A}$ resistive load.

Top trace: output voltage (2 V/div.).
 Bottom trace: input voltage (5 V/div.).
 Time scale: (2 ms/div.).

Output Ripple & Noise

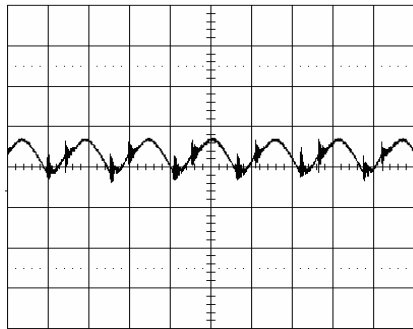

Output voltage ripple at:
 $T_{P1} = +25^\circ\text{C}$, $V_I = 12\text{ V}$,
 $I_O = 40\text{ A}$ resistive load.

Trace: output voltage (50 mV/div.).
 Time scale: (2 μs/div.).

Output Load Transient Response

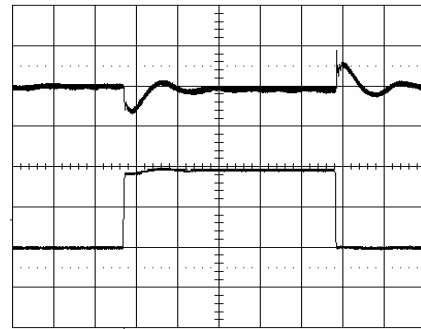

Output voltage response to load current step-
 change (10-30-10 A) at:
 $T_{P1} = +25^\circ\text{C}$, $V_I = 12\text{ V}$, $C_O = 4.4\text{ mF}$.

Top trace: output voltage (100 mV/div.).
 Bottom trace: load current (10 A/div.).
 Time scale: (0.2 ms/div.).

BMR 451 Digital PoL Regulators
Input 4.5-14 V, Output up to 40 A / 132 W

EN/LZT 146 401 R3B December 2011

© Ericsson AB

EMC Specification

Conducted EMI measured according to test set-up and standard MIL std 0141 – 58000.
The fundamental switching frequency is 320 kHz for BMR 451.

Conducted EMI Input terminal value (typ)

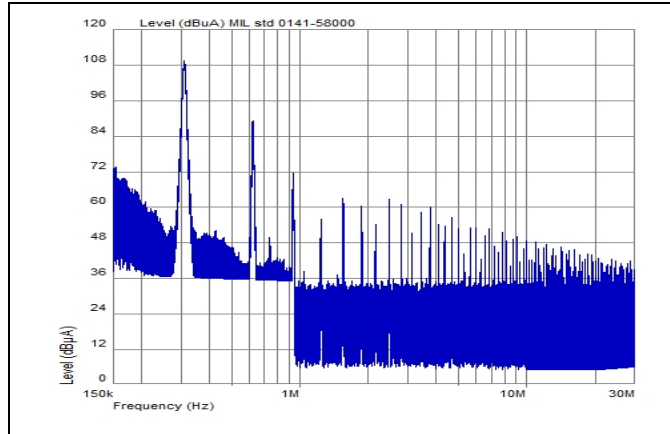

EMI without filter

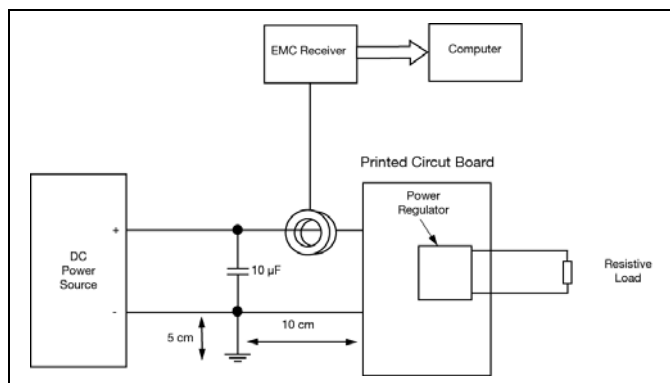

Test set-up

Layout Recommendations

The radiated EMI performance of the product will depend on the PCB layout and ground layer design. It is also important to consider the stand-off of the product. If a ground layer is used, it should be connected to the output of the product and the equipment ground or chassis.

A ground layer will increase the stray capacitance in the PCB and improve the high frequency EMC performance.

Output Ripple and Noise

Output ripple and noise is measured with the filter according to figure below. A 50 mm conductor works as a small inductor forming together with the two capacitances a damped filter.

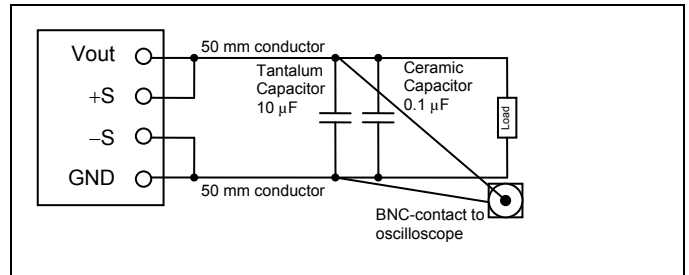

Output ripple and noise test set-up.

Operating Information

Input Voltage

The input voltage range, 4.5 - 14 V, makes the products easy to use in intermediate bus applications when powered by a non-regulated bus converter or a regulated bus converter. See Ordering Information for input voltage range.

Turn-off Input Voltage Range

The product monitors the input voltage and will turn-on and turn-off at configured levels. The default turn-on input voltage level setting is 4.4 V, whereas the corresponding turn-off input voltage level is 4.0 V. Hence, the default hysteresis between turn-on and turn-off input voltage is 0.4 V. The turn-on and turn-off levels can be reconfigured using the PMBus interface. Please contact your local Ericsson Power Modules representative for design support of custom configurations or appropriate SW tools for design and down-load of new configurations.

Remote Control

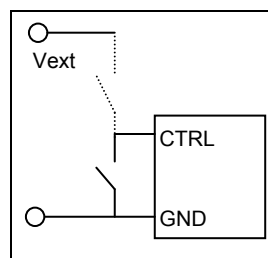

The product is equipped with a remote control function, i.e., the CTRL pin. The remote control can be referenced to either the primary negative input connection (GND) or to an external voltage (Vext), which is a 3 - 5 V positive supply voltage in accordance with the SMBus Specification version 2.0.

The CTRL function allows the product to be turned on/off by an external device like a semiconductor or mechanical switch. By default the product will turn on with the CTRL pin is left open and turn off when the CTRL pin is applied to GND. The CTRL pin has an internal pull-up resistor. The maximum required sink current is 0.5 mA. When the CTRL pin is left open, the voltage generated on the CTRL pin is max 6 V. The product can also be configured using the PMBus to be "Always on", i.e., starts

BMR 451 Digital PoL Regulators
Input 4.5-14 V, Output up to 40 A / 132 W

EN/LZT 146 401 R3B December 2011

© Ericsson AB

immediately when an appropriate input voltage is applied, or turn on/off can be performed with PMBus commands. Please contact your local Ericsson Power Modules representative for design support of custom configurations or appropriate SW tools for design and down-load of new configurations.

Input and Output Impedance

The impedance of both the input source and the load will interact with the impedance of the product. It is important that the input source has low characteristic impedance. The products are designed for a stable operation (30 degrees phase margin) without external capacitors connected to the input or output. The performance in some applications can be enhanced by addition of external capacitance as described under External Capacitors. If the input voltage source contains significant inductance, the addition of a 470 μF capacitor with low ESR at the input of the product will ensure stable operation.

External Decoupling Capacitors

Input capacitors:

The recommended input capacitor has a minimum capacitance of 470 μF and a low ESR. The ripple current rating of the capacitor must be at least 4 A rms. For high-performance/transient applications or wherever the input source performance is degraded, additional low ESR ceramic type capacitors at the input is recommended. The additional input low ESR capacitance above the minimum level insures an optimized performance.

Output capacitors:

The recommended output capacitor has a minimum capacitance of 680 μF and a low ESR. When powering loads with significant dynamic current requirements, the voltage regulation at the point of load can be improved by addition of decoupling capacitors at the load.

The most effective technique is to locate low ESR ceramic and electrolytic capacitors as close to the load as possible, using several capacitors in parallel to lower the effective ESR. The ceramic capacitors will handle high-frequency dynamic load changes while the electrolytic capacitors are used to handle low frequency dynamic load changes. Ceramic capacitors will also reduce high frequency noise at the load. It is equally important to use low resistance and low inductance PCB layouts and cabling.

External decoupling capacitors are a part of the control loop of the product and may affect the stability margins. The ESR of the capacitors is a very important parameter. Stable operation is guaranteed for an ESR value of $>5 \text{ m}\Omega$ and a total capacitance in the range defined in the electrical specification. For a total capacitance outside this range or with lower ESR a re-configuration will be necessary for robust dynamic operation and stability. Please contact your local Ericsson Power Modules representative for design support of custom configurations or appropriate SW tools for design and down-load of new configurations.

Control Loop Compensation

The product is configured with a robust control loop compensation which allows for a wide range operation of input and output voltages and capacitive loads as defined in the electrical specification. For an application with a specific input voltage, output voltage, and capacitive load, the control loop can be optimized for a robust and stable operation and with an improved load transient response. Please contact your local Ericsson Power Modules representative for design support of custom configurations or appropriate SW tools for design and down-load of new configurations.

Load Transient Response Optimization

The product incorporates a Non-Linear transient Response, NLR, loop that decreases the response time and the output voltage deviation during a load transient. The NLR results in a higher equivalent loop bandwidth than is possible using a traditional linear control loop. The product is pre-configured with appropriate NLR settings for robust and stable operation for a wide range of input voltage and a capacitive load range as defined in the electrical specification. For an application with a specific input voltage, output voltage, and capacitive load, the NLR configuration can be optimized for a robust and stable operation and with an improved load transient response. Please contact your local Ericsson Power Modules representative for design support of custom configurations or appropriate SW tools for design and down-load of new configurations.

Remote Sense

The product has remote sense that can be used to compensate for voltage drops between the output and the point of load. The sense traces should be located close to the PCB ground layer to reduce noise susceptibility. The remote sense circuitry will compensate for up to 10% voltage drop between output pins and the point of load.

If the remote sense is not needed +S should be connected to VOUT and -S should be connected to GND.

Output Voltage Adjust Range (default)

With Analog Output Voltage Adjust the output voltage can be set in the range 0.7 V to 3.3 V at 25 different levels by an external resistor, R_{SET} , which is applied between the FLEX pin and the -S pin. The resistor is sensed during boot-up of the regulator. Changing the resistor during normal operation will not change the output voltage. The input voltage must be at least 1 V larger than the output voltage in order to deliver the correct output voltage. If the input voltage is lower, the product will still deliver power with a lower output voltage than the set output voltage. The product will turn off at the input turn-off voltage level, according to Turn-off Input Voltage Range.



BMR 451 Digital PoL Regulators
 Input 4.5-14 V, Output up to 40 A / 132 W

EN/LZT 146 401 R3B December 2011

© Ericsson AB

The following table shows recommended resistor values for R_{SET} .

V_{OUT} [V]	$R_{set}[k\Omega]$			V_{OUT} [V]	$R_{set}[k\Omega]$		
	Min	Typ	Max		Min	Typ	Max
0.7	155.00	159.00	169.00	0.991	21.38	21.60	21.82
0.752	109.89	111.00	112.11	1.00	18.51	18.70	18.89
0.758	99.00	100.00	101.00	1.10	15.94	16.10	16.26
0.765	89.10	90.00	90.90	1.158	13.56	13.70	13.84
0.772	80.09	80.90	81.71	1.20	11.39	11.50	11.62
0.79	64.35	72.50	73.23	1.25	9.50	9.60	9.70
0.80	57.52	58.10	58.68	1.50	7.72	7.80	7.88
0.821	51.38	51.90	52.42	1.669	6.14	6.20	6.26
0.848	40.69	41.10	41.51	1.80	4.65	4.70	4.75
0.88	36.04	36.40	36.76	2.295	3.27	3.30	3.33
0.899	31.88	32.20	32.52	2.506	2.08	2.10	2.12
0.919	28.02	28.30	28.58	3.30	0.99	1.00	1.01
0.965	24.55	24.80	25.05				

Output Voltage Adjust using PMBus

The output voltage of the product can be reconfigured using the PMBus interface in the range 0.6 V to 3.6 V with the resolution of 1 mV. Please contact your local Ericsson Power Modules representative for design support of custom configurations or appropriate SW tools for design and down-load of new configurations.

Maximum Output Voltage Protection

The regulator can be configured for maximum output voltage protection. The Analog Voltage Adjust sets the maximum output voltage equal to 10% higher than the nominal output value set by the R_{SET} . This works as a hardware protection for the load, avoiding destroying the load by an over voltage. Please contact your local Ericsson Power Modules representative for design support of custom configurations or appropriate SW tools for design and down-load of new configurations.

Synchronization

Synchronization is a feature that allows multiple DC/DC regulators to be synchronized to a common frequency. Synchronized regulators powered from the same bus eliminate beat frequencies reflected back to the input supply, and also reduces EMI filtering requirements. Eliminating the slow beat frequencies (usually < 10 kHz) allows the EMI filter to be designed to attenuate only the synchronization frequency. Synchronization can also be utilized for interleaving, described in section Interleaving. The product FLEX pin can be configured for synchronization. Hence, Analog Voltage Adjust is disabled, when the synchronization is enabled. The regulators can be synchronized with an external oscillator or one regulator can be configured with the FLEX pin as an SYNC Output working as a master driving the synchronization. All

others on the same synchronization bus should be configured with SYNC Input or SYNC Auto Detect (Default configuration) for correct operation. When the FLEX pin is configured in auto detect mode the product will automatically check for a clock signal on the FLEX pin. The switching frequency can also be set to any value between 200 kHz and 400 kHz using the PMBus interface. Please contact your local Ericsson Power Modules representative for design support of custom configurations or appropriate SW tools for design and down-load of new configurations.

Interleaving

When multiple DC/DC regulators share a common DC input supply, interleaving, or spreading of the switching clock phase between the regulators can be utilized. This dramatically reduces input capacitance requirements and efficiency losses, since the peak current drawn from the input supply is effectively spread out over the whole switch period. This requires that the DC/DC regulators are synchronized. Up to 16 different interleaving phases can be used. The interleaving of the product can be reconfigured using the PMBus interface. Please contact your local Ericsson Power Modules representative for design support of custom configurations or appropriate SW tools for design and down-load of new configurations.

Parallel Operation

Parallel operation is not recommended.

Over Temperature Protection (OTP)

The products are protected from thermal overload by an internal over temperature shutdown circuit. When T_{P1} as defined in thermal consideration section exceeds 120°C the product will shut down. The product will make continuous attempts to start up (non-latching mode) and resume normal operation automatically when the temperature has dropped >15°C below the temperature threshold. Please contact your local Ericsson Power Modules representative for design support of custom configurations or appropriate SW tools for design and down-load of new configurations.

Over Current Protection (OCP)

The product includes current limiting circuitry for protection at continuous overload. The product will shut down immediately for output currents in excess of the current limit, I_{lim} . The product will try to restart every 70 ms, i.e., hiccup mode, and resume normal operation after removal of the overload. The load distribution should be designed for the maximum output short circuit current specified. Please contact your local Ericsson Power Modules representative for design support of custom configurations or appropriate SW tools for design and down-load of new configurations.

Soft-start Power Up

The soft-start control introduces a time-delay (default setting 10 ms) before allowing the output voltage to rise. The default rise time of the ramp up is 10 ms. Power-up is hence completed within 20 ms in default configuration using remote control.

BMR 451 Digital PoL Regulators
 Input 4.5-14 V, Output up to 40 A / 132 W

EN/LZT 146 401 R3B December 2011

© Ericsson AB

When starting by applying input voltage the control circuit boot-up time adds an additional 10 ms delay. Please contact your local Ericsson Power Modules representative for design support of custom configurations or appropriate SW tools for design and down-load of new configurations.

Output Voltage Sequencing

A group of regulators may be configured to power up in a predetermined sequence. This feature is especially useful when powering advanced processors, FPGAs, and ASICs that require one supply to reach its operating voltage prior to another supply reaching its operating voltage. Multi-regulator sequencing can be achieved by configuring each device start delay and rise time through the PMBus and use the same remote control start signal. Please contact your local Ericsson Power Modules representative for design support of custom configurations or appropriate SW tools for design and down-load of new configurations.

Voltage Margining Up/Down

The regulator can momentarily adjust its output higher or lower than its nominal voltage setting in order to determine whether the load device is capable of operating over its specified supply voltage range. This provides a convenient method for dynamically testing the operation of the load circuit over its supply margin or range. It can also be used to verify the function of supply voltage supervisors. Margin limits of the nominal output voltage $\pm 5\%$ are default, but the margin limits can be reconfigured using the PMBus interface to as high as 10% or as low as 0V. Please contact your local Ericsson Power Modules representative for design support of custom configurations or appropriate SW tools for design and down-load of new configurations.

Pre-Bias Startup Capability

Pre-bias startup often occurs in complex digital systems when current from another power source is fed back through a dual-supply logic component, such as FPGAs or ASICs. The BMR 451 product family incorporates synchronous rectifiers, but will not sink current during startup, or turn off, or whenever a fault shuts down the product in a pre-bias condition with right configuration. Please contact your local Ericsson Power Modules representative for design support of custom configurations or appropriate SW tools for design and down-load of new configurations.

I²C/SMBus Setup and Hold Times – Definitions

The setup time, t_{set} , is the time the data, SDA, must be stable before the rising edge of the clock signal, SCL. The hold time t_{hold} , is the time the data must be stable after the rising edge of the clock signal, SCL. If these times are violated incorrect data can be captured or meta-stability can occur and the bus communication fails.

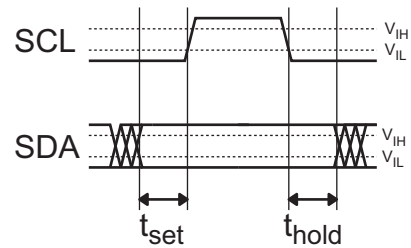

SMBus timing diagram

BMR 451 Digital PoL Regulators
Input 4.5-14 V, Output up to 40 A / 132 W

EN/LZT 146 401 R3B December 2011

© Ericsson AB

Thermal Consideration

General

The regulators are designed to operate in different thermal environments and sufficient cooling must be provided to ensure reliable operation. Cooling is achieved mainly by conduction, from the pins to the host board, and convection, which is dependant on the airflow across the regulator. Increased airflow enhances the cooling of the regulator.

The Output Current Derating graph found in the Output section for each model provides the available output current vs. ambient air temperature and air velocity at specified V_I .

The products with an output power of ≥ 100 W are tested on a 254 x 254 mm, 35 μ m (1 oz), 16-layer test board, and for output power of < 100 W a 254 x 254 mm, 35 μ m (1 oz), 8-layer test board are used. The test board is mounted vertically in a wind tunnel with a cross-section of 608 x 203 mm.

Proper cooling of the product can be verified by measuring the temperature at position P1. The temperature at this position should not exceed the max values provided in the table below. The number of points may vary with different thermal design and topology.

Note that the max value is the absolute maximum rating (non destruction) and that the electrical Output data is guaranteed up to T_{P1} equal to 85 degrees.

See Design Note 019 for further information.

Position	Device	Designation	Max value
P1	L1	T_{P1}	120° C

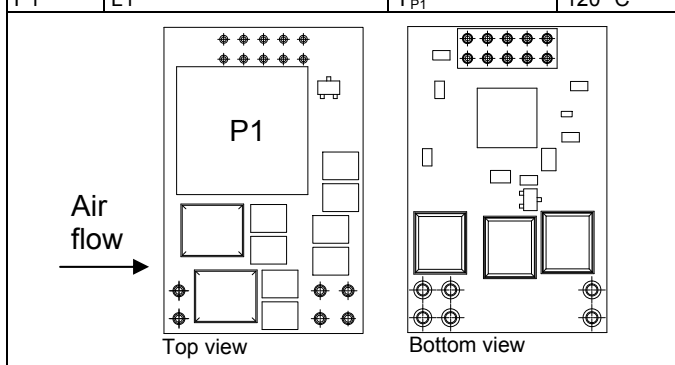

The diagram illustrates the top and bottom views of the regulator. The top view shows a central square component labeled 'P1' with several smaller components around it. The bottom view shows the underside of the regulator with various components and mounting points. An arrow labeled 'Air flow' points from left to right, indicating the direction of airflow across the device. Temperature measurement points are indicated by circles with crosses, primarily located around the central component and along the edges.

Temperature positions and air flow direction.

Definition of Reference Temperature T_{P1}

The reference temperature is used to monitor the temperature limits of the product. Temperature above maximum T_{P1} , measured at the reference point P1 are not allowed and may cause degradation or permanent damage to the product. T_{P1} is also used to define the temperature range for normal operating conditions. T_{P1} is defined by the design and used to guarantee safety margins, proper operation and high reliability of the product.

Power Management Overview

The product incorporates a wide range of monitorable and configurable power management features that are simple to implement with a minimum of external components. Additionally, the product includes protection features that continuously safeguard the load from damage due to unexpected system faults. A fault is also shown as an alert on the SALERT pin. The following product parameters can continuously be monitored by a host: Input voltage, output voltage/current, and internal temperature. If the monitoring is not needed it can be disabled and the module enters a low power mode reducing the power consumption. The protection features are not affected.

All power management functions can be configured via the PMBus interface. Monitoring parameters can be pre-configured to provide alerts for specific conditions. Please contact your local Ericsson Power Modules representative for design support of custom configurations or appropriate SW tools for design and down-load of new configurations.

Efficiency Optimized Dead Time Control

The regulator utilizes a closed loop algorithm to optimize the dead-time applied between the gate drive signals for the switch and synch FETs. The algorithm constantly adjusts the deadtime non-overlap to minimize the duty cycle, thus maximizing efficiency. This algorithm will null out deadtime differences due to component variation, temperature and loading effects. The algorithm can be configured via the PMBus. Please contact your local Ericsson Power Modules representative for design support of custom configurations or appropriate SW tools for design and down-load of new configurations.

BMR 451 Digital PoL Regulators
 Input 4.5-14 V, Output up to 40 A / 132 W

EN/LZT 146 401 R3B December 2011

© Ericsson AB

Connections

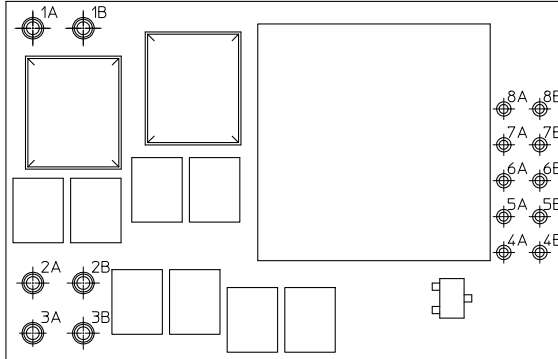

Pin layout, top view.

Pin	Designation	Function
1A, 1B	VIN	Input Voltage
2A, 2B	GND	Power Ground
3A, 3B	VOUT	Output Voltage
4A	+S	Positive sense
4B	-S	Negative sense
5A	SA0	Address pin 0
5B	SA1	Address pin 1
6A	SCL	PMBus Clock
6B	SDA	PMBus Data
7A	FLEX	Analog Voltage Adjust / Synchronization
7B	DGND	PMBus Ground
8A	SALERT	PMBus Alert
8B	CTRL	PMBus Control (Remote Control)

A typical application circuit when using Synchronization and PMBus Voltage Adjust.

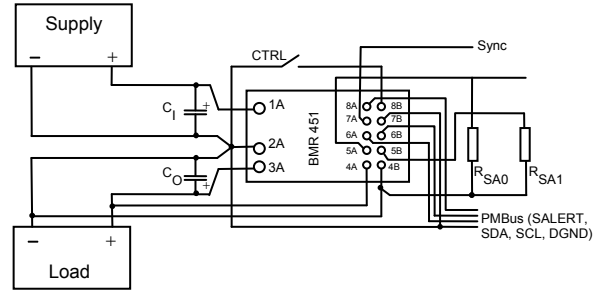

The resistors, R_{SA0} and R_{SA1} , are used for addressing, described in section Addressing.

Typical Application Circuit

A typical application circuit when using Analog Voltage Adjust.

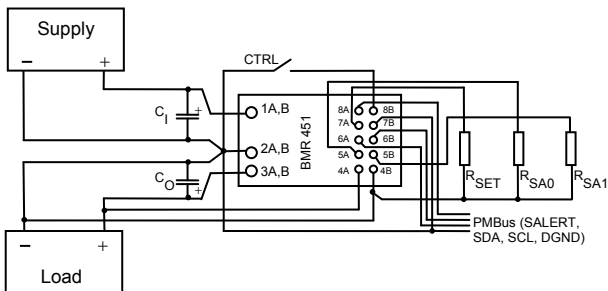

BMR 451 Digital PoL Regulators
Input 4.5-14 V, Output up to 40 A / 132 W

EN/LZT 146 401 R3B December 2011

© Ericsson AB

PMBus Interface

The regulator provides a digital PMBus interface that enables the user to monitor the input and output parameters. The PMBus interface can also be used for configuration of the regulator. The products can be used with any standard 2-wire I²C or SMBus host device. In addition, the device is compatible with PMBus version 1.1 and includes an SALERT line to help mitigate bandwidth limitations related to continuous fault monitoring. The PMBus signals, SCL, SDA, SALERT requires passive pull-up resistors as stated in the SMBus Specification.

Monitoring via PMBus

A system controller can monitor a wide variety of different parameters through the PMBus interface. The controller can monitor for fault condition by monitoring the SALERT pin, which will be asserted when any number of pre-configured fault or warning conditions occur. The system controller can also continuously monitor for any number of power conversion parameters including but not limited to the following:

- Input voltage
- Output voltage
- Output current
- Internal junction temperature
- Switching frequency
- Duty cycle

Software Tools for Design and Production

Ericsson provides software for configuration and monitoring of this product via the PMBus interface. For more information please contact your local Ericsson sales representative.

PMBus Addressing

The PMBus address should be configured with resistors connected between SA0 and SA1 pin to the -S pin, as shown in the figure. Recommended resistor values for hard-wiring PMBus addresses (series E96, 1% tolerance resistors suggested) are shown in the table.

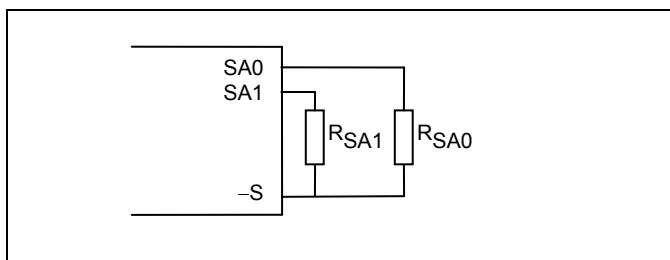

Schematic of connection of address resistors.

SA0/SA1 Index	R _{SA0} /R _{SA1} [kΩ]	SA0/SA1 Index	R _{SA0} /R _{SA1} [kΩ]
0	10	13	34.8
1	11	14	38.3
2	12.1	15	42.2
3	13.3	16	46.4
4	14.7	17	51.1
5	16.2	18	56.2
6	17.8	19	61.9
7	19.6	20	68.1
8	21.5	21	75
9	23.7	22	82.5
10	26.1	23	90.9
11	28.7	24	100
12	31.6		

The PMBus address follows the equation below:

$$\text{PMBus Address} = 25 \times (\text{SA1 index}) + (\text{SA0 index})$$

The user can theoretically configure up to 625 unique PMBus addresses, however the PMBus address range is inherently limited to 128. Therefore, the user should use index values 0 - 4 on the SA1 pin and the full range of index values on the SA0 pin, which will provide 124 device address combinations (The address 0d75 is allocated for production needs and can not be used.). The user shall also be aware of further limitations of the address space as stated in the SMBus Specification (Note that 0-12, 40, 44, 45, 55, 64-68 in decimal are reserved and may not be usable).

BMR 451 Digital PoL Regulators
 Input 4.5-14 V, Output up to 40 A / 132 W

EN/LZT 146 401 R3B December 2011

© Ericsson AB

PMBus Commands

The DC/DC regulators are PMBus compliant. The following table lists the implemented PMBus commands. For more detailed information see PMBus Power System Management Protocol Specification; Part I – General Requirements, Transport and Electrical Interface and PMBus Power System Management Protocol; Part II – Command Language.

Designation	Cmd	Impl
Standard PMBus Commands		
Control Commands		
PAGE	00h	No
OPERATION	01h	Yes
ON_OFF_CONFIG	02h	Yes
WRITE_PROTECT	10h	No
Output Commands		
VOUT_MODE (Read Only)	20h	Yes
VOUT_COMMAND	21h	Yes
VOUT_TRIM	22h	Yes
VOUT_CAL_GAIN	23h	Yes
VOUT_MAX	24h	Yes
VOUT_MARGIN_HIGH	25h	Yes
VOUT_MARGIN_LOW	26h	Yes
VOUT_TRANSITION_RATE	27h	Yes
VOUT_DROOP	28h	Yes
MAX_DUTY	32h	Yes
FREQUENCY_SWITCH	33h	Yes
IOUT_CAL_GAIN	38h	Yes
IOUT_CAL_OFFSET	39h	Yes
VOUT_SCALE_LOOP	29h	No
VOUT_SCALE_MONITOR	2Ah	No
COEFFICIENTS	30h	No
Fault Limit Commands		
POWER_GOOD_ON	5Eh	Yes
VOUT_OV_FAULT_LIMIT	40h	Yes
VOUT_UV_FAULT_LIMIT	44h	Yes
IOUT_OC_FAULT_LIMIT	46h	Yes
IOUT_UC_FAULT_LIMIT	4Bh	Yes
OT_FAULT_LIMIT	4Fh	Yes
OT_WARN_LIMIT	51h	Yes
UT_WARN_LIMIT	52h	Yes
UT_FAULT_LIMIT	53h	Yes
VIN_OV_FAULT_LIMIT	55h	Yes

VIN_UV_WARN_LIMIT	58h	Yes
VIN_UV_FAULT_LIMIT	59h	Yes
VOUT_OV_WARN_LIMIT	42h	No
VOUT_UV_WARN_LIMIT	43h	No
IOUT_OC_WARN_LIMIT	4Ah	No
Fault Response Commands		
VOUT_OV_FAULT_RESPONSE	41h	Yes
VOUT_UV_FAULT_RESPONSE	45h	Yes
OT_FAULT_RESPONSE	50h	Yes
UT_FAULT_RESPONSE	54h	Yes
VIN_OV_FAULT_RESPONSE	56h	Yes
VIN_UV_FAULT_RESPONSE	5Ah	Yes
IOUT_OC_FAULT_RESPONSE	47h	No
IOUT_UC_FAULT_RESPONSE	4Ch	No
Time setting Commands		
TON_DELAY	60h	Yes
TON_RISE	61h	Yes
TOFF_DELAY	64h	Yes
TOFF_FALL	65h	Yes
TON_MAX_FAULT_LIMIT	62h	No
Status Commands (Read Only)		
CLEAR_FAULTS	03h	Yes
STATUS_BYTE	78h	Yes
STATUS_WORD	79h	Yes
STATUS_VOUT	7Ah	Yes
STATUS_IOUT	7Bh	Yes
STATUS_INPUT	7Ch	Yes
STATUS_TEMPERATURE	7Dh	Yes
STATUS_CML	7Eh	Yes
Monitor Commands (Read Only)		
READ_VIN	88h	Yes
READ_VOUT	8Bh	Yes
READ_IOUT	8Ch	Yes
READ_TEMPERATURE_1	8Dh	Yes
READ_TEMPERATURE_2	8Eh	No
READ_FAN_SPEED_1	90h	No
READ_DUTY_CYCLE	94h	Yes
READ_FREQUENCY	95h	Yes
Identification Commands (Read Only)		
PMBUS_REVISION	98h	Yes
MFR_ID	99h	Yes
MFR_MODEL	9Ah	Yes

BMR 451 Digital PoL Regulators
 Input 4.5-14 V, Output up to 40 A / 132 W

EN/LZT 146 401 R3B December 2011

© Ericsson AB

MFR_LOCATION	9Ch	Yes
MFR_DATE	9Dh	Yes
MFR_SERIAL	9Eh	Yes
Group Commands		
INTERLEAVE	37h	Yes
Supervisory Commands		
STORE_DEFAULT_ALL	11h	Yes
RESTORE_DEFAULT_ALL	12h	Yes
STORE_USER_ALL	15h	No
RESTORE_USER_ALL	16h	No
BMR 450 Specific Commands		
Time Setting Commands		
POWER_GOOD_DELAY	D4h	Yes
Fault limit Commands		
IOUT_AVG_OC_FAULT_LIMIT	E7h	Yes
IOUT_AVG_UC_FAULT_LIMIT	E8h	Yes
Fault Response Commands		
MFR_IOUT_OC_FAULT_RESPONSE	E5h	Yes
MFR_IOUT_UC_FAULT_RESPONSE	E6h	Yes
OVUV_CONFIG	D8h	Yes
Configuration and Control Commands		
MFR_CONFIG	D0h	Yes
USER_CONFIG	D1h	Yes
PID_TAPS	D5h	Yes
NLR_CONFIG	D7h	Yes
TEMPCO_CONFIG	DCh	Yes
DEADTIME	DDh	Yes
DEADTIME_CONFIG	DEh	Yes
POLA_VADJ_CONFIG	D6h	Yes
Group Commands		
SEQUENCE	E0h	Yes
Supervisory Commands		
USER_PASSWORD (PUBLIC)	FCh	Yes
UNPROTECT	FDh	Yes
SECURITY_LEVEL	FAh	Yes

Notes:

Cmd is short for Command.

Impl is short for Implemented.

BMR 451 Digital PoL Regulators
 Input 4.5-14 V, Output up to 40 A / 132 W

EN/LZT 146 401 R3B December 2011

© Ericsson AB

Mechanical Information – Hole Mount , Open Frame Version

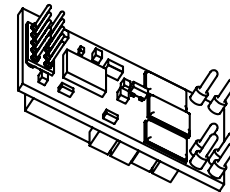
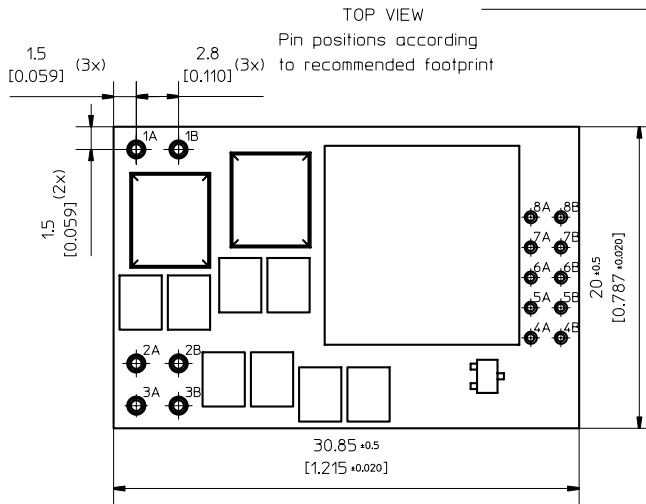
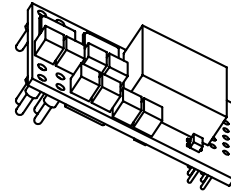
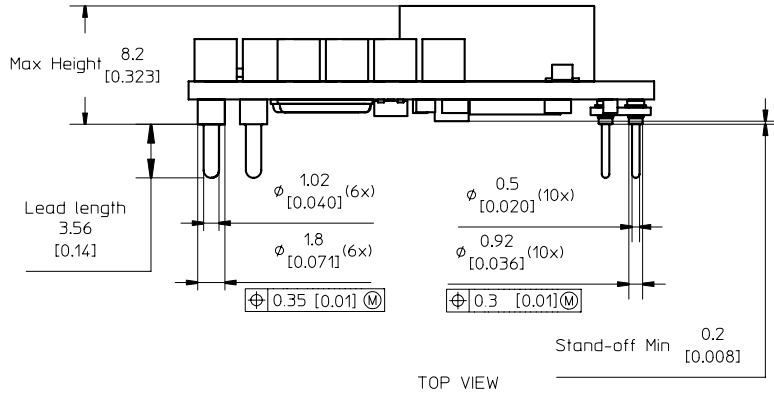

RECOMMENDED FOOTPRINT - TOP VIEW

PIN SPECIFICATIONS

PIN 1A-3B Material: Copper alloy
 Plating: Min Au 0.1 μ m over 1-3 μ m Ni.
 PIN 4A-8B Material: Brass
 Plating: Min Au 0.1 μ m over 2 μ m Ni.

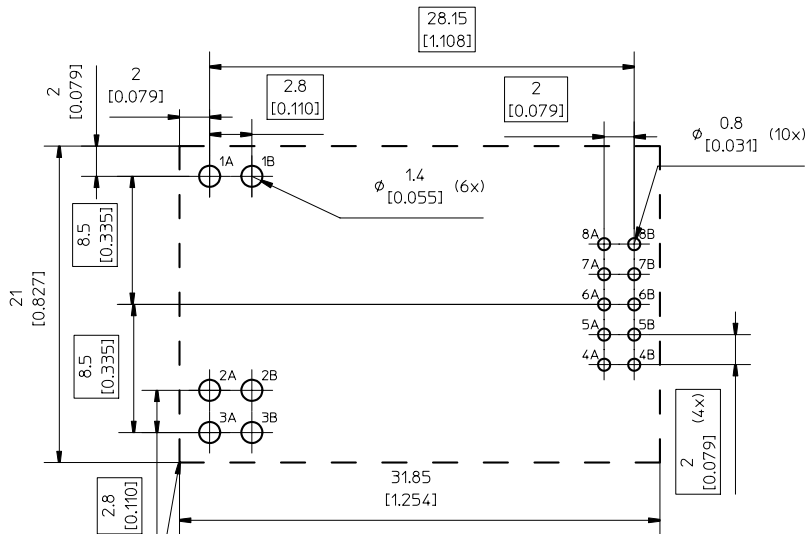

Recommended keep out area for user components

Weight: Typical 10.5 g
 All dimensions in mm [inch]
 Tolerances unless specified \pm 0.25 [0.01]
 (not applied on footprint or typical values)

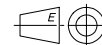

BMR 451 Digital PoL Regulators
 Input 4.5-14 V, Output up to 40 A / 132 W

EN/LZT 146 401 R3B December 2011

© Ericsson AB

Mechanical Information – Surface Mount Version

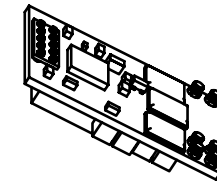
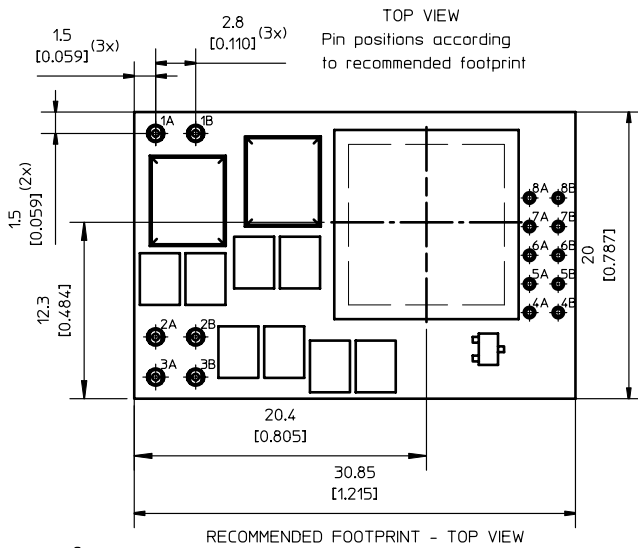
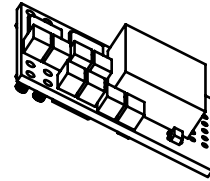
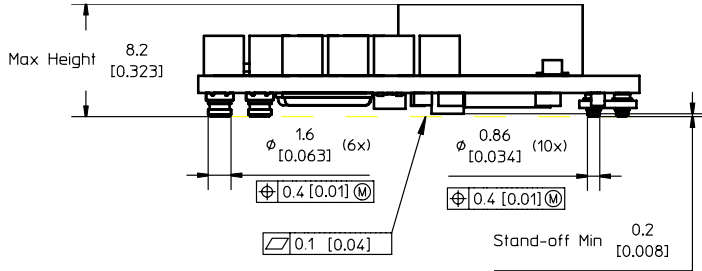

PIN SPECIFICATIONS

PIN 1A-3B Material: Copper alloy
 Plating: Min Au 0.1 μm over 1-3 μm Ni.
 PIN 4A-8B Material: Brass
 Plating: Min Au 0.1 μm over 2 μm Ni.

PICK-UP SURFACE

Recommended pick-up nozzle size for assigned pick-up area is maximum $\varnothing 8$ [0.315].

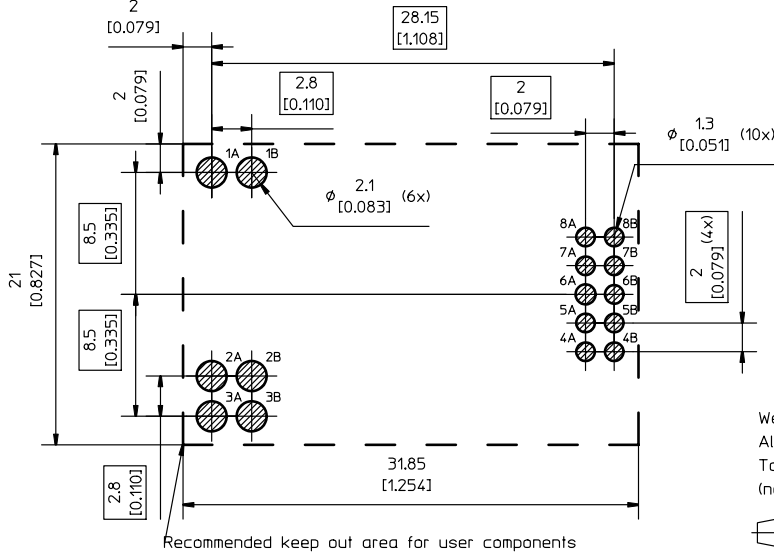

Weight: Typical 10.5g
 All dimensions in mm [inch]
 Tolerances unless specified ± 0.25 [0.01]
 (not applied on footprint or typical values)



BMR 451 Digital PoL Regulators
Input 4.5-14 V, Output up to 40 A / 132 W

EN/LZT 146 401 R3B December 2011

© Ericsson AB

Soldering Information - Surface Mounting

The surface mount product is intended for forced convection or vapor phase reflow soldering in SnPb and Pb-free processes.

The reflow profile should be optimised to avoid excessive heating of the product. It is recommended to have a sufficiently extended preheat time to ensure an even temperature across the host PCB and it is also recommended to minimize the time in reflow.

A no-clean flux is recommended to avoid entrapment of cleaning fluids in cavities inside the product or between the product and the host board, since cleaning residues may affect long time reliability and isolation voltage.

Minimum Pin Temperature Recommendations

Pin number 3A is chosen as reference location for the minimum pin temperature recommendation since this will likely be the coolest solder joint during the reflow process.

SnPb solder processes

For SnPb solder processes, a pin temperature (T_{PIN}) in excess of the solder melting temperature, (T_L , 183°C for Sn63Pb37) for more than 30 seconds and a peak temperature of 210°C is recommended to ensure a reliable solder joint.

For dry packed products only: depending on the type of solder paste and flux system used on the host board, up to a recommended maximum temperature of 245°C could be used, if the products are kept in a controlled environment (dry pack handling and storage) prior to assembly.

General reflow process specifications		SnPb eutectic	Pb-free
Average ramp-up ($T_{PRODUCT}$)		3°C/s max	3°C/s max
Typical solder melting (liquidus) temperature	T_L	183°C	221°C
Minimum reflow time above T_L		30 s	30 s
Minimum pin temperature	T_{PIN}	210°C	235°C
Peak product temperature	$T_{PRODUCT}$	225°C	260°C
Average ramp-down ($T_{PRODUCT}$)		6°C/s max	6°C/s max
Maximum time 25°C to peak		6 minutes	8 minutes

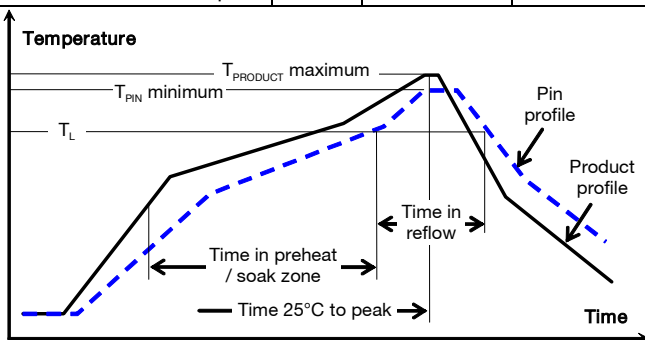

Lead-free (Pb-free) solder processes

For Pb-free solder processes, a pin temperature (T_{PIN}) in excess of the solder melting temperature (T_L , 217 to 221°C for SnAgCu solder alloys) for more than 30 seconds and a peak temperature of 235°C on all solder joints is recommended to ensure a reliable solder joint.

Maximum Product Temperature Requirements

Top of the product PCB near pin 8B is chosen as reference location for the maximum (peak) allowed product temperature ($T_{PRODUCT}$) since this will likely be the warmest part of the product during the reflow process.

SnPb solder processes

For SnPb solder processes, the product is qualified for MSL 1 according to IPC/JEDEC standard J-STD-020C.

During reflow $T_{PRODUCT}$ must not exceed 225 °C at any time.

Pb-free solder processes

For Pb-free solder processes, the product is qualified for MSL 3 according to IPC/JEDEC standard J-STD-020C.

During reflow $T_{PRODUCT}$ must not exceed 260 °C at any time.

Dry Pack Information

Products intended for Pb-free reflow soldering processes are delivered in standard moisture barrier bags according to IPC/JEDEC standard J-STD-033 (Handling, packing, shipping and use of moisture/reflow sensitivity surface mount devices).

Using products in high temperature Pb-free soldering processes requires dry pack storage and handling. In case the products have been stored in an uncontrolled environment and no longer can be considered dry, the modules must be baked according to J-STD-033.

Thermocoupler Attachment

Pin 8B for measurement of maximum product temperature

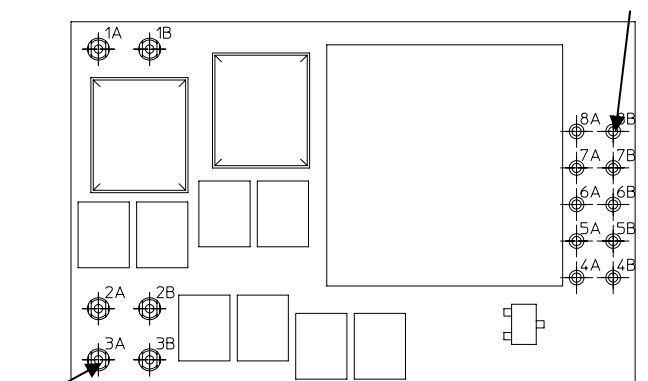

Pin 3A for measurement of minimum Pin (solder joint) temperature T_{PIN}

BMR 451 Digital PoL Regulators
 Input 4.5-14 V, Output up to 40 A / 132 W

EN/LZT 146 401 R3B December 2011

© Ericsson AB

Soldering Information - Hole Mounting

The hole mounted product is intended for plated through hole mounting by wave or manual soldering. The pin temperature is specified to maximum to 270°C for maximum 10 seconds.

A maximum preheat rate of 4°C/s and maximum preheat temperature of 150°C is suggested. When soldering by hand, care should be taken to avoid direct contact between the hot soldering iron tip and the pins for more than a few seconds in order to prevent overheating.

A no-clean flux is recommended to avoid entrapment of cleaning fluids in cavities inside the product or between the product and the host board. The cleaning residues may affect long time reliability and isolation voltage.

Delivery Package Information

The products are delivered in antistatic injection molded trays (Jedec design guide 4.10D standard).

Tray Specifications	
Material	Antistatic PPE
Surface resistance	$10^5 < \text{Ohm/square} < 10^{12}$
Bakability	The trays can be baked at maximum 125°C for 48 hours
Tray thickness	14.50 mm 0.571 [inch]
Box capacity	150 products (5 full trays/box)
Tray weight	160 g empty, 475 g full tray

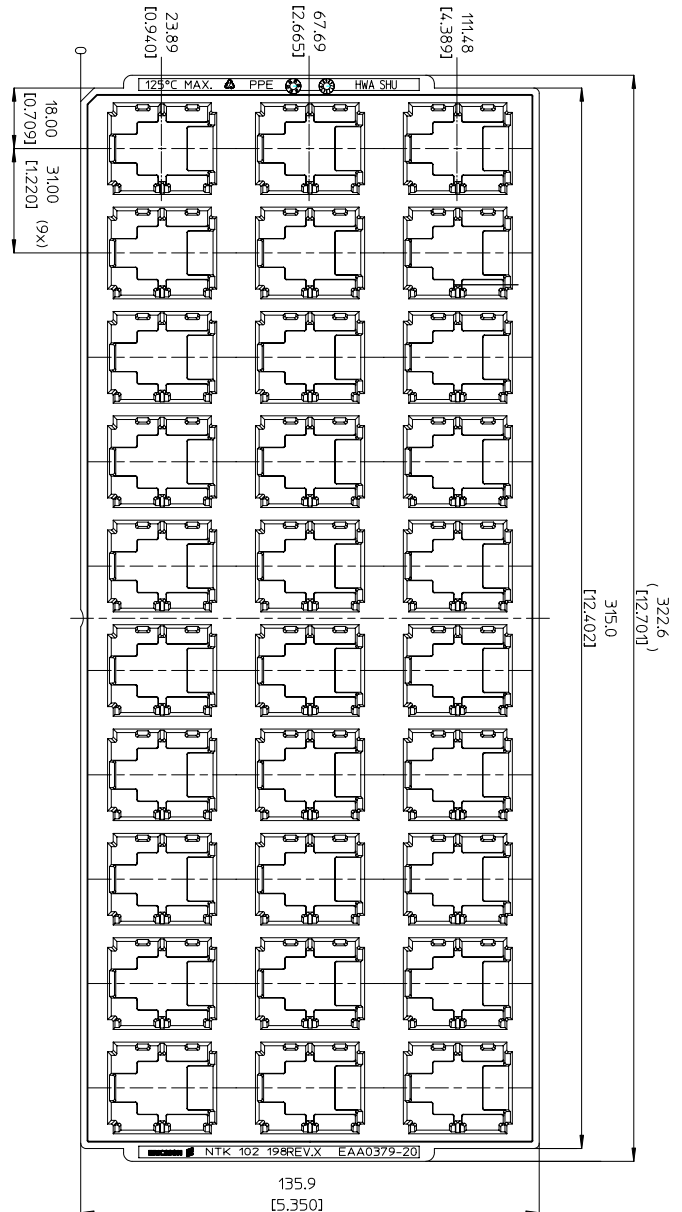

JEDEC standard tray for 3x10 = 30 products.

All dimensions in mm [inch]

Tolerances: X.x ±0.26 [0.01], X.xx ±0.13 [0.005]

Note: pick up positions refer to center of pocket.
 See mechanical drawing for exact location on product.

BMR 451 Digital PoL Regulators
 Input 4.5-14 V, Output up to 40 A / 132 W

EN/LZT 146 401 R3B December 2011

© Ericsson AB

Product Qualification Specification

Characteristics			
External visual inspection	IPC-A-610		
Change of temperature (Temperature cycling)	IEC 60068-2-14 Na	Temperature range Number of cycles Dwell/transfer time	-40 to 100°C 1000 15 min/0-1 min
Cold (in operation)	IEC 60068-2-1 Ad	Temperature T _A Duration	-45°C 72 h
Damp heat	IEC 60068-2-67 Cy	Temperature Humidity Duration	85°C 85 % RH 1000 hours
Dry heat	IEC 60068-2-2 Bd	Temperature Duration	125°C 1000 h
Electrostatic discharge susceptibility	IEC 61340-3-1, JESD 22-A114 IEC 61340-3-2, JESD 22-A115	Human body model (HBM) Machine Model (MM)	Class 2, 2000 V Class 3, 200 V
Immersion in cleaning solvents	IEC 60068-2-45 XA, method 2	Water Glycol ether Isopropyl alcohol	55°C 35°C 35°C
Mechanical shock	IEC 60068-2-27 Ea	Peak acceleration Duration	100 g 6 ms
Moisture reflow sensitivity ¹	J-STD-020C	Level 1 (SnPb-eutectic) Level 3 (Pb Free)	225°C 260°C
Operational life test	MIL-STD-202G, method 108A	Duration	1000 h
Resistance to soldering heat ²	IEC 60068-2-20 Tb, method 1A	Solder temperature Duration	270°C 10-13 s
Robustness of terminations	IEC 60068-2-21 Test Ua1 IEC 60068-2-21 Test Ue1	Through hole mount products Surface mount products	All leads All leads
Solderability	IEC 60068-2-58 test Td ¹	Preconditioning Temperature, SnPb Eutectic Temperature, Pb-free	150°C dry bake 16 h 215°C 235°C
	IEC 60068-2-20 test Ta ²	Preconditioning Temperature, SnPb Eutectic Temperature, Pb-free	Steam ageing 235°C 245°C
Vibration, broad band random	IEC 60068-2-64 Fh, method 1	Frequency Spectral density Duration	10 to 500 Hz 0.07 g ² /Hz 10 min in each direction

Notes
¹ Only for products intended for reflow soldering (surface mount products)

² Only for products intended for wave soldering (plated through hole products)

AMEYA360

Components Supply Platform

Authorized Distribution Brand :



Website :

Welcome to visit www.ameya360.com

Contact Us :

➤ Address :

401 Building No.5, JiuGe Business Center, Lane 2301, Yishan Rd
Minhang District, Shanghai , China

➤ Sales :

Direct +86 (21) 6401-6692

Email amall@ameya360.com

QQ 800077892

Skype [ameyasales1](#) [ameyasales2](#)

➤ Customer Service :

Email service@ameya360.com

➤ Partnership :

Tel +86 (21) 64016692-8333

Email mkt@ameya360.com