

# General Specifications

## Electrical Capacity (Resistive Load)

<b>Switching Rating:</b>	100mA @ 5V DC
<b>Nonswitching Rating:</b>	100mA @ 50V DC

## Other Ratings

<b>Contact Resistance:</b>	80 milliohms maximum for circuit; 30 milliohms maximum for contact point
<b>Insulation Resistance:</b>	1,000 megohms minimum @ 250V DC
<b>Dielectric Strength:</b>	250V AC minimum for 1 minute minimum
<b>Mechanical Life:</b>	20,000 detent operations minimum
<b>Electrical Life:</b>	20,000 detent operations minimum
	Notes: A detent operation is one actuator position operation or stepping. 20,000 detent operations = 1,250 cycles for hexadecimal devices or 2,000 cycles for decimal devices. A cycle is one 360° rotation.
<b>Nominal Operating Torque:</b>	0.006Nm
<b>Contact Timing:</b>	Nonshorting (break-before-make)

## Materials & Finishes

<b>Actuator:</b>	Glass fiber reinforced polyamide
<b>Housing:</b>	Glass fiber reinforced polyamide (UL94V-0)
<b>O-ring:</b>	Nitrile butadiene rubber
<b>Base:</b>	Glass fiber reinforced polyamide (UL94V-0)
<b>Movable Contact:</b>	Beryllium copper with gold plating
<b>Stationary Contacts:</b>	Brass with gold plating
<b>Terminals:</b>	Brass with gold plating

## Environmental Data

<b>Operating Temperature Range:</b>	-25°C through +75°C (-13°F through +167°F)
<b>Humidity:</b>	90 ~ 95% humidity for 96 hours @ 40°C (104°F)
<b>Vibration:</b>	10 ~ 55Hz with peak-to-peak amplitude of 1.5mm traversing the frequency range & returning in 1 minute; 3 right angled directions for 2 hours
<b>Shock:</b>	50G (490m/s <sup>2</sup> ) acceleration (tested in 6 right angled directions, with 5 shocks in each direction)

## Processing

<b>Soldering:</b>	Wave Soldering Recommended: See Profile B in Supplement section. Note: During Wave Soldering process, set the switch to the following position: NDFR10, NDFR16, NDKR10, NDKR16: 0 position; NDFC10, NDKC10: 7 position; NDFC16, NDKC16: F position. Manual Soldering: See Profile B in Supplement section.
<b>Cleaning:</b>	Automated Cleaning. See Cleaning Specifications in Supplement section.

## Standards & Certifications

<b>Flammability Standards:</b>	UL94V-0 rated housing & base The ND Series rotaries have not been tested for UL recognition or CSA certification. These switches are designed for use in a low-voltage, low-current, logic-level circuit. When used as intended in a logic-level circuit, the results do not produce hazardous energy.
--------------------------------	---

# Distinctive Characteristics

Sealed construction prevents contact contamination and allows automated soldering and cleaning. Sealed design accomplished with seals between the actuator and housing and between housing and base.

Highly visible legends and choice of screwdriver or shaft actuation to provide trouble-free code setting.

Detent mechanism designed for crisp, positive action for accurate switch setting.

Bifurcated, spring loaded contacts give unmatched logic-level reliability.

Heat tolerant resin used for body meets UL flammability rating of 94V-0 and maintains switch reliability through automated soldering process.

Crimped terminals ensure secure PC mounting and prevent dislodging during soldering.

.100" (2.54mm) terminal grid spacing between pin centers, plus 3-by-3 terminal arrangement for footprint pattern equivalent to industry standard.

Epoxy sealed terminals lock out flux, solvents, and other contaminants.

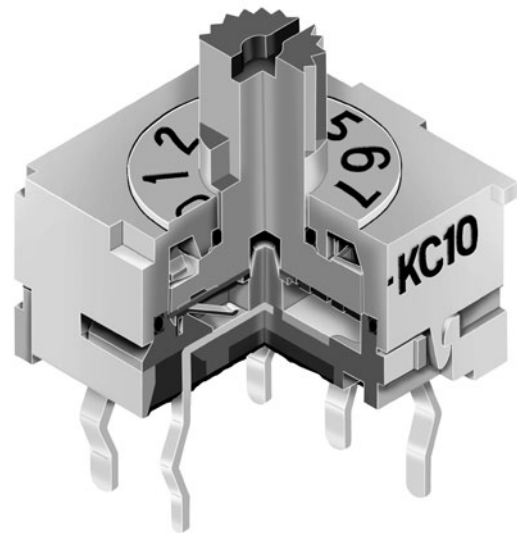

Actual Size

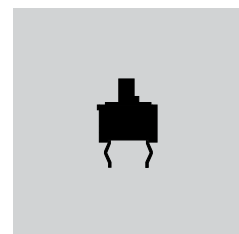

## TYPICAL SWITCH ORDERING EXAMPLE

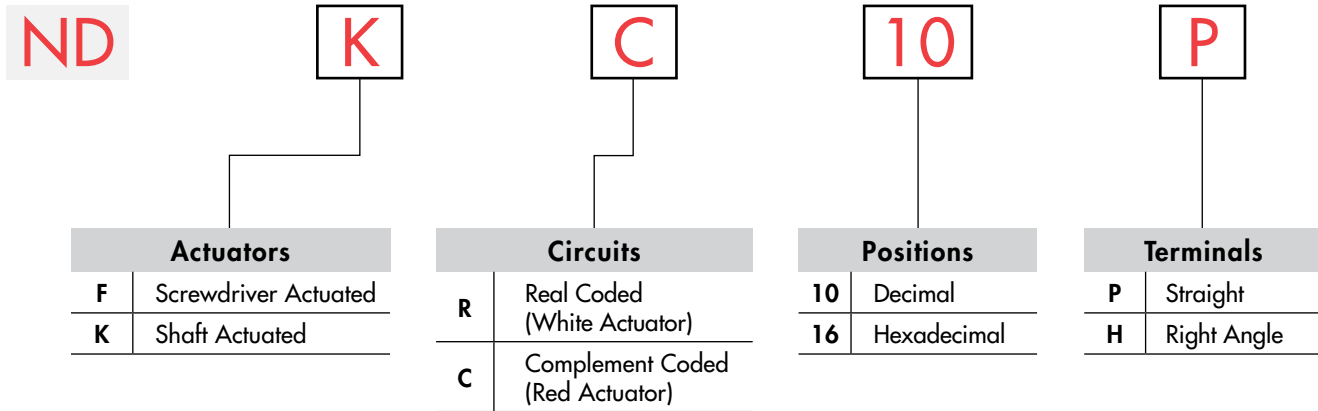

### DESCRIPTION FOR TYPICAL ORDERING EXAMPLE

**NDKC10P**

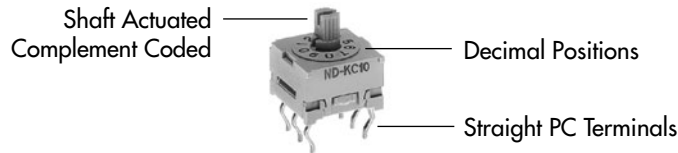

## ACTUATORS

**F**

**Screwdriver Actuated**

Actuator colors:  
White for real coded  
Red for complement coded

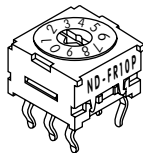

**K**

**Shaft Actuated**

Actuator colors:  
White for real coded  
Red for complement coded

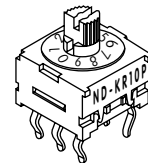

Actuators are fully rotational in either direction.

## TRUTH TABLES (CIRCUITS & POSITIONS)

Terminal No. (Output)	Actuator Position ● = ON	10 Decimal									16 Hexadecimal																		
		0	1	2	3	4	5	6	7	8	9	0	1	2	3	4	5	6	7	8	9	A	B	C	D	E	F		
<b>R</b> Real Coded Model Numbers: NDFR, NDKR	1		●		●		●		●		●		●		●		●		●		●		●		●		●		●
	2			●	●			●	●				●	●			●	●				●	●				●	●	
	4					●	●	●	●					●	●	●	●					●	●	●	●				
	8								●	●									●	●	●	●							
<b>C</b> Complement Coded Model Numbers: NDFC, NDKC	1	●		●		●		●		●		●		●		●		●		●		●		●		●		●	
	2	●	●			●	●			●	●			●	●			●	●			●	●			●	●		
	4	●	●	●	●				●	●	●	●						●	●	●	●								
	8	●	●	●	●	●	●	●						●	●	●	●	●											

TYPICAL SWITCH DIMENSIONS

Screwdriver Actuated • Straight PC

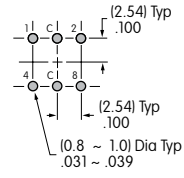
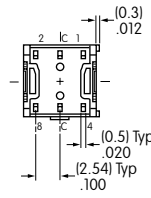
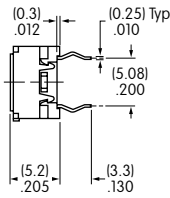
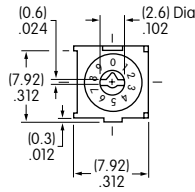

Terminal numbers are not on switch

NDFR10P

Shaft Actuated • Straight PC

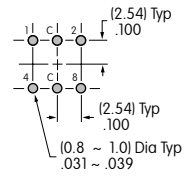
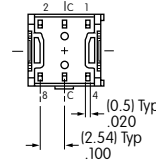
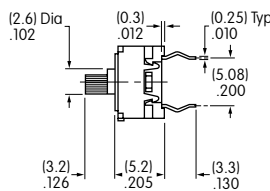
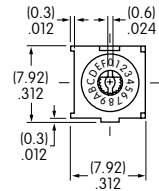

Terminal numbers are not on switch

NDKC16P

Screwdriver Actuated • Right Angle PC

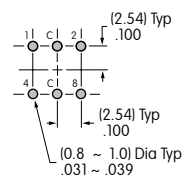
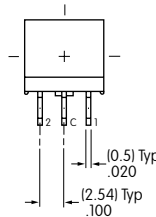
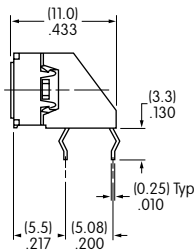
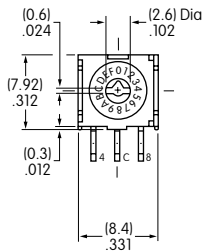

Terminal numbers are on terminal cover

NDFC16H

Shaft Actuated • Right Angle PC

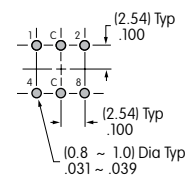
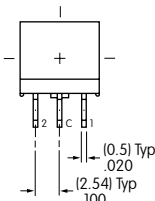
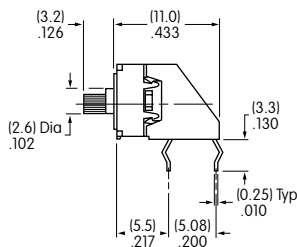
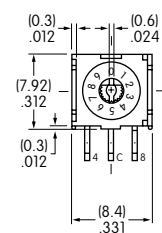

Terminal numbers are on terminal cover

NDKR10H

# AMEYA360

## Components Supply Platform

Authorized Distribution Brand :



Website :

Welcome to visit [www.ameya360.com](http://www.ameya360.com)

Contact Us :

➤ Address :

401 Building No.5, JiuGe Business Center, Lane 2301, Yishan Rd  
Minhang District, Shanghai , China

➤ Sales :

Direct +86 (21) 6401-6692

Email [amall@ameya360.com](mailto:amall@ameya360.com)

QQ 800077892

Skype [ameyasales1](#) [ameyasales2](#)

➤ Customer Service :

Email [service@ameya360.com](mailto:service@ameya360.com)

➤ Partnership :

Tel +86 (21) 64016692-8333

Email [mkt@ameya360.com](mailto:mkt@ameya360.com)