

## FAMILY OF NANOPOWER PUSH-PULL OUTPUT COMPARATORS

### FEATURES

- Qualified for Automotive Applications
- ESD Protection Exceeds 2000 V Per MIL-STD-883, Method 3015; Exceeds 200 V Using Machine Model (C = 200 pF, R = 0)
- Low Supply Current . . . 560 nA/Per Channel
- Input Common-Mode Range Exceeds the Rails . . . -0.1 V to  $V_{CC} + 5$  V
- Supply Voltage Range . . . 2.7 V to 16 V
- Reverse Battery Protection Up to 18 V
- Push-Pull CMOS Output Stage
- Specified Temperature Range
  - -40°C to 125°C – Automotive Grade
- Ultrasmall Packaging
  - 5-Pin SOT-23 (TLV3701)
- Universal Op-Amp EVM (Reference SLOU060 for more information)

### APPLICATIONS

- Low Power Automotive Electronics
- Security Detection Systems

### DESCRIPTION

The TLV370x is Texas Instruments' first family of nanopower comparators with only 560 nA per channel supply current, which make this device ideal for low power applications.

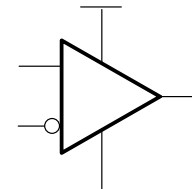

SUPPLY CURRENT vs SUPPLY VOLTAGE

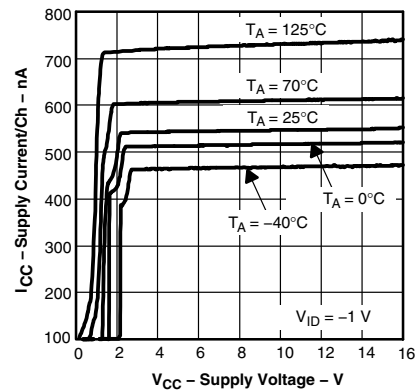

### high side voltage sense circuit

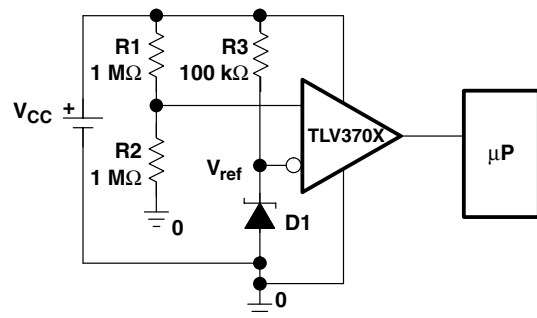

Please be aware that an important notice concerning availability, standard warranty, and use in critical applications of Texas Instruments semiconductor products and disclaimers thereto appears at the end of this data sheet.

**DESCRIPTION (continued)**

The TLV370x has a minimum operating supply voltage of 2.7 V over the extended automotive temperature range ( $T_A = -40^{\circ}\text{C}$  to  $125^{\circ}\text{C}$ ), while having an input common-mode range of  $-0.1$  to  $V_{CC} + 5$  V. The low supply current makes it an ideal choice for low power applications where quiescent current is the primary concern. Reverse battery protection guards the amplifier from an over-current condition due to improper battery installation. For harsh environments, the inputs can be taken 5 V above the positive supply rail without damage to the device.

Devices are available in SOIC with the singles in the small SOT-23 package. Other package options may be made available upon request.

**A SELECTION OF OUTPUT COMPARATORST**

DEVICE	V <sub>CC</sub> (V)	V <sub>IO</sub> ( $\mu\text{V}$ )	I <sub>CC/Ch</sub> ( $\mu\text{A}$ )	I <sub>B</sub> (pA)	t <sub>PLH</sub> ( $\mu\text{s}$ )	t <sub>PHL</sub> ( $\mu\text{s}$ )	t <sub>f</sub> ( $\mu\text{s}$ )	t <sub>r</sub> ( $\mu\text{s}$ )	RAIL-TO-RAIL	OUTPUT STAGE
TLV370x	2.5 – 16	250	0.56	80	56	83	22	8		PP
TLV340x	2.5 – 16	250	0.47	80	55	30	5	–		OD
TLC3702/4	3 – 16	1200	9	5	1.1	0.65	0.5	0.125	–	PP
TLC393/339	3 – 16	1400	11	5	1.1	0.55	0.22	–	–	OD
TLC372/4	3 – 16	1000	75	5	0.65	0.65	–	–	–	OD

† All specifications are typical values measured at 5 V.

**TLV3701 AVAILABLE OPTIONST**

T <sub>A</sub>	V <sub>IOmax</sub> AT 25°C	PACKAGED DEVICES‡		
		SMALL OUTLINE (D)	SOT-23 (DBV)¶	SYMBOL
-40°C to 125°C	5000 $\mu\text{V}$	TLV3701QDRQ1§	TLV3701QDBVRQ1	VBCQ

† For the most current package and ordering information, see the Package Option Addendum at the end of this document, or see the TI web site at <http://www.ti.com>.

‡ Package drawings, thermal data, and symbolization are available at <http://www.ti.com/packaging>.

§ Product Preview

¶ This package is only available taped and reeled with standard quantities of 3000 pieces per reel.

**TLV3702 AVAILABLE OPTIONS**

T <sub>A</sub>	V <sub>IOmax</sub> AT 25°C	PACKAGED DEVICES	
		SMALL OUTLINE (D)	SYMBOL
-40°C to 125°C	5000 $\mu\text{V}$	TLV3702QDRQ1	3702Q1

**TLV3704 AVAILABLE OPTIONS**

T <sub>A</sub>	V <sub>IOmax</sub> AT 25°C	PACKAGED DEVICES
		SMALL OUTLINE (D)
-40°C to 125°C	5000 $\mu\text{V}$	TLV3704QDRQ1†

† Product Preview

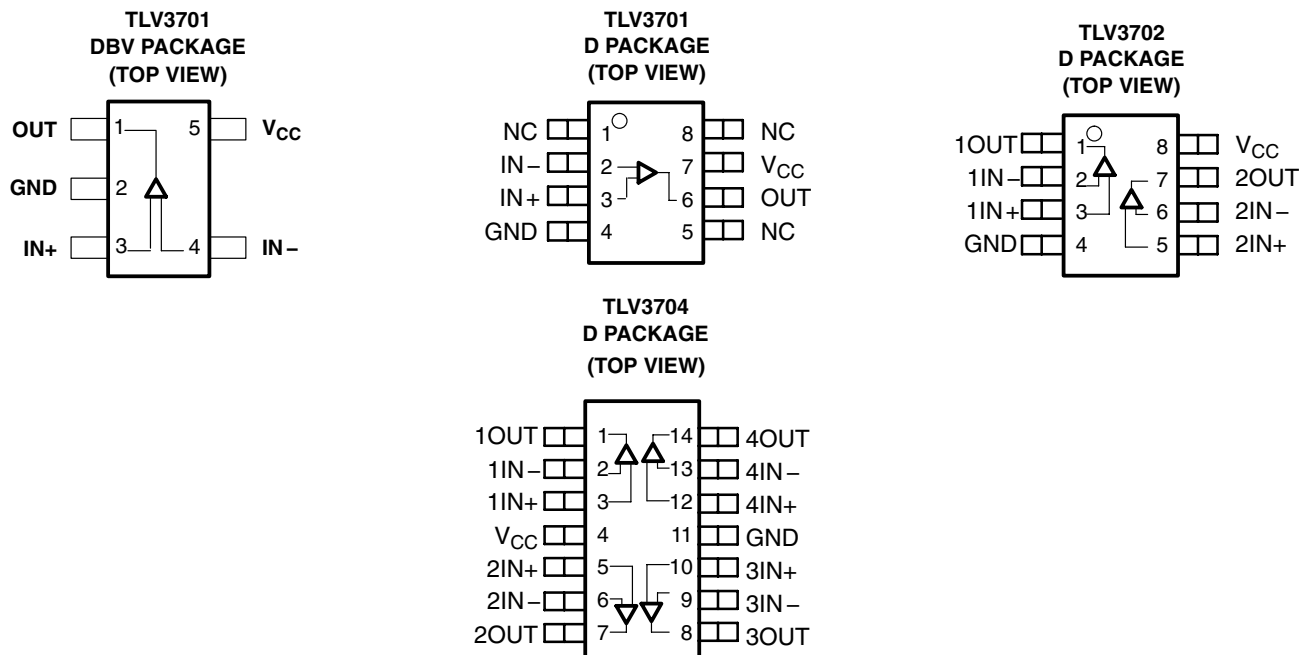

**absolute maximum ratings over operating free-air temperature range (unless otherwise noted)<sup>†</sup>**

Supply voltage, V <sub>CC</sub> (see Note 1) .....	17 V
Differential input voltage, V <sub>ID</sub> .....	±20 V
Input voltage range, V <sub>I</sub> (see Notes 1 and 2) .....	-0.3 V to V <sub>CC</sub> + 5 V
Input current range, I <sub>I</sub> .....	±10 mA
Output current range, I <sub>O</sub> .....	±10 mA
Continuous total power dissipation .....	See Dissipation Rating Table
Operating free-air temperature range, T <sub>A</sub> : Q suffix .....	-40°C to 125°C
Maximum junction temperature, T <sub>J</sub> .....	150°C
Storage temperature range, T <sub>stg</sub> .....	-65°C to 150°C
Lead temperature 1,6 mm (1/16 inch) from case for 10 seconds .....	260°C

<sup>†</sup> Stresses beyond those listed under “absolute maximum ratings” may cause permanent damage to the device. These are stress ratings only, and functional operation of the device at these or any other conditions beyond those indicated under “recommended operating conditions” is not implied. Exposure to absolute-maximum-rated conditions for extended periods may affect device reliability.

- NOTES: 1. All voltage values, except differential voltages, are with respect to GND.  
 2. Input voltage range is limited to 20 V max or V<sub>CC</sub> + 5 V, whichever is smaller.

**DISSIPATION RATING TABLE**

PACKAGE	θ <sub>JC</sub> (°C/W)	θ <sub>JA</sub> (°C/W)	T <sub>A</sub> ≤ 25°C POWER RATING	T <sub>A</sub> = 125°C POWER RATING
D (8)	38.3	176	710 mW	142 mW
D (14)	26.9	122.6	1022 mW	204.4 mW
DBV (5)	55	324.1	385 mW	77.1 mW

**recommended operating conditions**

		MIN	MAX	UNIT
Supply voltage, $V_{CC}$	Single supply	2.7	16	V
	Split supply	$\pm 1.35$	$\pm 8$	
Common-mode input voltage range, $V_{ICR}$		-0.1	$V_{CC}+5$	V
Operating free-air temperature, $T_A$		-40	125	$^{\circ}\text{C}$

**electrical characteristics at specified operating free-air temperature,  $V_{CC} = 2.7\text{ V}, 5\text{ V}, 15\text{ V}$  (unless otherwise noted)**

**dc performance**

PARAMETER		TEST CONDITIONS	$T_A^{\dagger}$	MIN	TYP	MAX	UNIT
$V_{IO}$ Input offset voltage		$V_{IC} = V_{CC}/2, R_S = 50\ \Omega$	25 $^{\circ}\text{C}$	250	5000		$\mu\text{V}$
			Full range		7000		
$\alpha_{VIO}$ Offset voltage drift			25 $^{\circ}\text{C}$	3			$\mu\text{V}/^{\circ}\text{C}$
CMRR Common-mode rejection ratio		$V_{IC} = 0\text{ to }2.7\text{ V}, R_S = 50\ \Omega$	25 $^{\circ}\text{C}$	55	72		dB
			Full range	50			
		$V_{IC} = 0\text{ to }5\text{ V}, R_S = 50\ \Omega$	25 $^{\circ}\text{C}$	60	76		
			Full range	55			
$V_{IC} = 0\text{ to }15\text{ V}, R_S = 50\ \Omega$	25 $^{\circ}\text{C}$	65	88				
	Full range	60					
$A_{VD}$ Large-signal differential voltage amplification			25 $^{\circ}\text{C}$	1000			V/mV

$\dagger$  Full range is -40 $^{\circ}\text{C}$  to 125 $^{\circ}\text{C}$  for Q suffix.

**input/output characteristics**

PARAMETER		TEST CONDITIONS	$T_A^{\dagger}$	MIN	TYP	MAX	UNIT
$I_{IO}$ Input offset current		$V_{IC} = V_{CC}/2, R_S = 50\ \Omega$	25 $^{\circ}\text{C}$	20	100		pA
			Full range		1000		
$I_{IB}$ Input bias current			25 $^{\circ}\text{C}$	80	250		pA
			Full range		2000		
$r_{i(d)}$ Differential input resistance			25 $^{\circ}\text{C}$	300			M $\Omega$
$V_{OH}$ High-level output voltage		$V_{IC} = V_{CC}/2, I_{OH} = 2\ \mu\text{A}, V_{ID} = 1\text{ V}$	25 $^{\circ}\text{C}$	$V_{CC} - 0.08$			mV
			Full range	$V_{CC} - 320$			
		$V_{IC} = V_{CC}/2, I_{OH} = -50\ \mu\text{A}, V_{ID} = 1\text{ V}$	Full range	$V_{CC} - 450$			
$V_{OL}$ Low-level output voltage		$V_{IC} = V_{CC}/2, I_{OH} = 2\ \mu\text{A}, V_{ID} = -1\text{ V}$	25 $^{\circ}\text{C}$	8			mV
			Full range	80	200		
		$V_{IC} = V_{CC}/2, I_{OH} = 50\ \mu\text{A}, V_{ID} = -1\text{ V}$	Full range	300			

$\dagger$  Full range is -40 $^{\circ}\text{C}$  to 125 $^{\circ}\text{C}$  for Q suffix.

**electrical characteristics at specified operating free-air temperature,  $V_{CC} = 2.7\text{ V}, 5\text{ V}, 15\text{ V}$  (unless otherwise noted) (continued)**

**power supply**

PARAMETER		TEST CONDITIONS		$T_A^\dagger$	MIN	TYP	MAX	UNIT
$I_{CC}$	Supply current (per channel)	Output state high		25°C		560	800	nA
				Full range			1200	
PSRR	Power supply rejection ratio	$V_{IC} = V_{CC}/2\text{ V}$ , No load	$V_{CC} = 2.7\text{ V to }5\text{ V}$	25°C	75	100	dB	
				Full range	70			
			$V_{CC} = 5\text{ V to }15\text{ V}$	25°C	85	105		
				Full range	80			

† Full range is  $-40^\circ\text{C}$  to  $125^\circ\text{C}$  for Q suffix.

**switching characteristics at recommended operating conditions,  $V_{CC} = 2.7\text{ V}, 5\text{ V}, 15\text{ V}$ ,  $T_A = 25^\circ\text{C}$  (unless otherwise noted)**

PARAMETER		TEST CONDITIONS		MIN	TYP	MAX	UNIT
$t_{(PLH)}$	Propagation response time, low-to-high-level output (see Note 3)	$f = 1\text{ kHz}$ , $V_{STEP} = 100\text{ mV}$ , $C_L = 10\text{ pF}$ , $V_{CC} = 2.7\text{ V}$ , $V_{IC} = V_{CC}/2$	Overdrive = 2 mV		240		$\mu\text{s}$
			Overdrive = 10 mV		64	150†	
			Overdrive = 50 mV		36		
			$t_{(PHL)}$	Propagation response time, high-to-low-level output (see Note 3)	Overdrive = 2 mV		
Overdrive = 10 mV		67			150†		
Overdrive = 50 mV		37					
$t_r$	Rise time	$C_L = 10\text{ pF}$ , $V_{CC} = 2.7\text{ V}$		7		$\mu\text{s}$	
$t_f$	Fall time	$C_L = 10\text{ pF}$ , $V_{CC} = 2.7\text{ V}$		9		$\mu\text{s}$	

NOTE 3: The response time specified is the interval between the input step function and the instant when the output crosses 1.4 V. Propagation responses are longer at higher supply voltages, refer to Figures 11–16 for further details.

† This limit applies to the TLV3701-Q1 only.

**TYPICAL CHARACTERISTICS**

**Table of Graphs**

			FIGURE
	Input bias/offset current	vs Free-air temperature	1
$V_{OL}$	Low-level output voltage	vs Low-level output current	2, 4, 6
$V_{OH}$	High-level output voltage	vs High-level output current	3, 5, 7
$I_{CC}$	Supply current	vs Supply voltage	8
		vs Free-air temperature	9
	Output fall time/rise time	vs Supply voltage	10
	Low-to-high level output response for various input overdrives		11, 13, 15
	High-to-low level output response for various input overdrives		12, 14, 16

TYPICAL CHARACTERISTICS

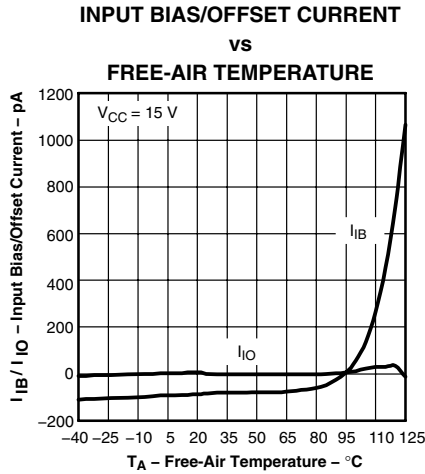

Figure 1

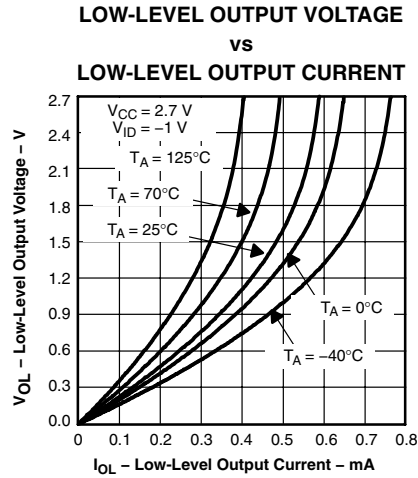

Figure 2

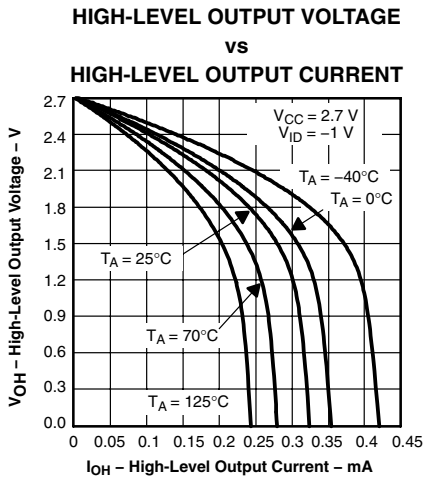

Figure 3

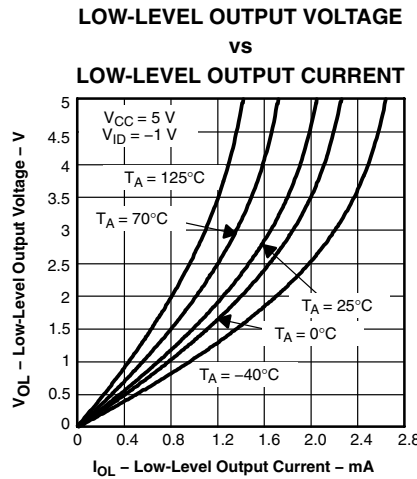

Figure 4

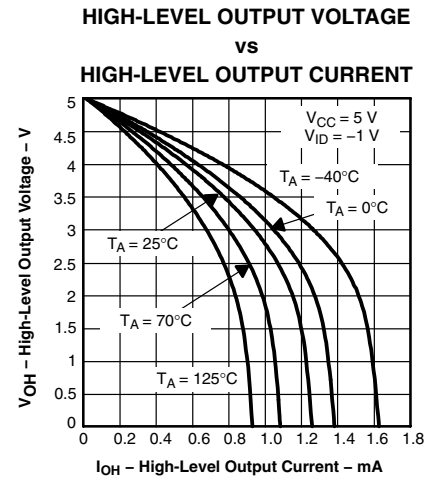

Figure 5

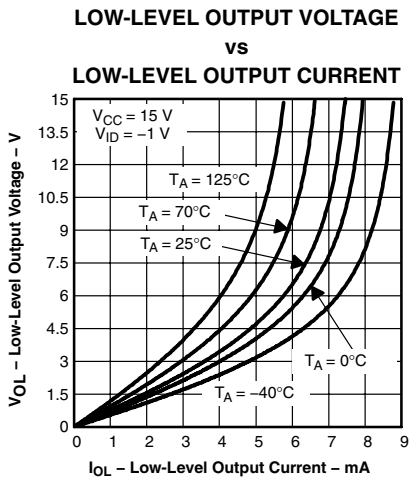

Figure 6

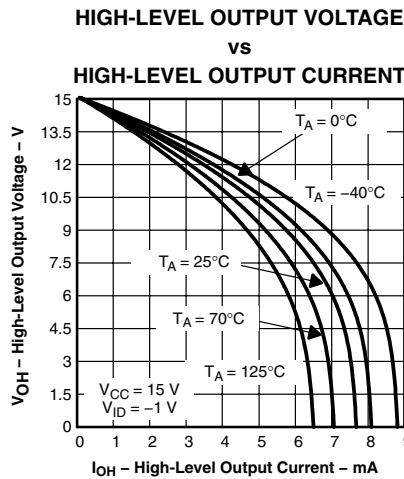

Figure 7

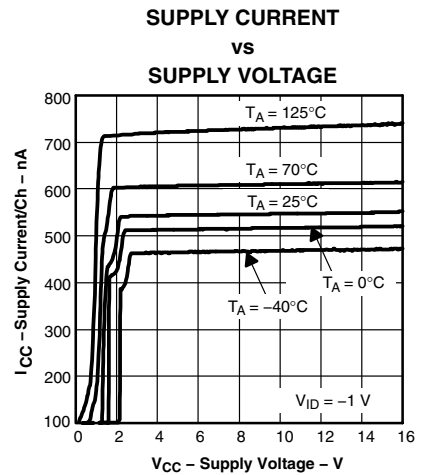

Figure 8

TYPICAL CHARACTERISTICS

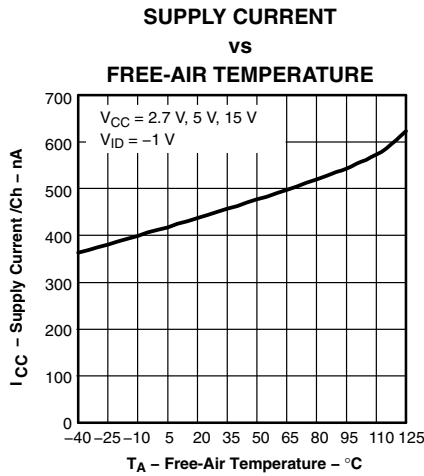

Figure 9

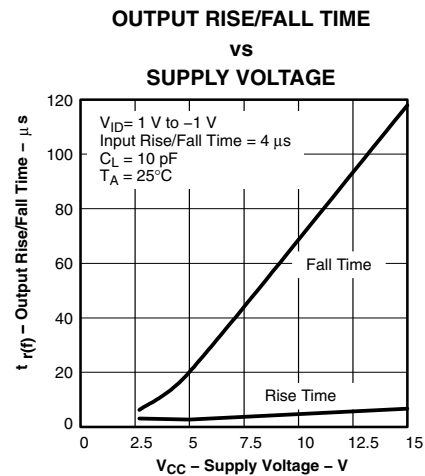

Figure 10

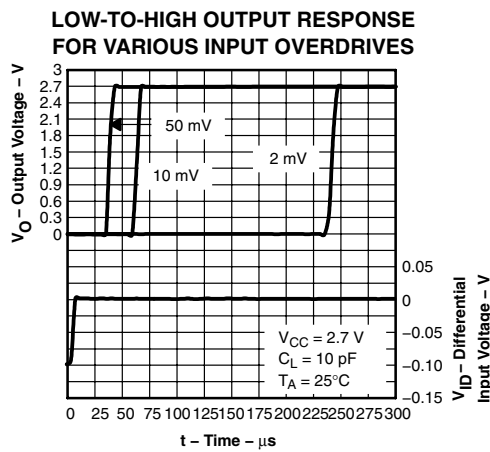

Figure 11

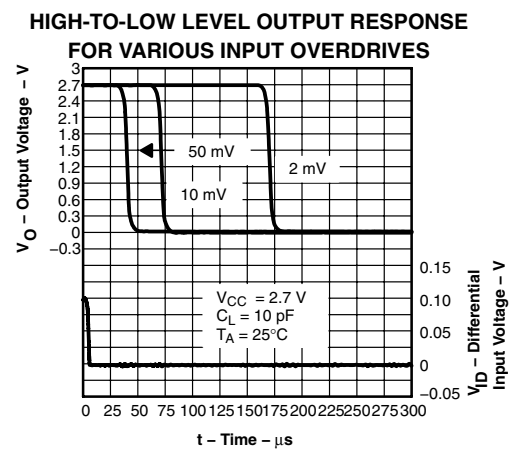

Figure 12

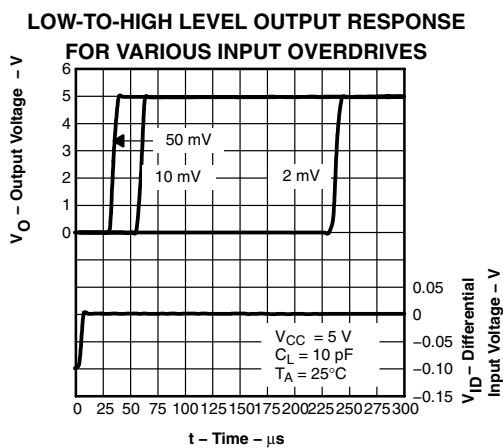

Figure 13

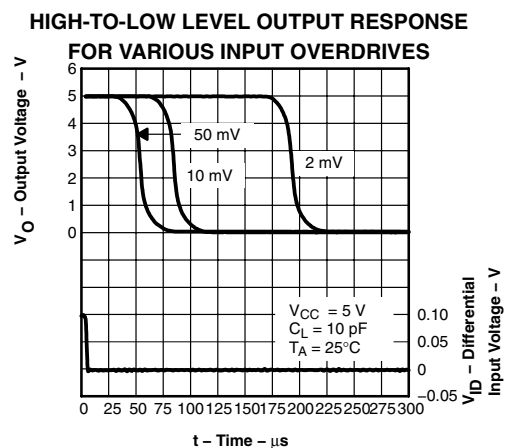

Figure 14

TYPICAL CHARACTERISTICS

LOW-TO-HIGH LEVEL OUTPUT RESPONSE  
 FOR VARIOUS INPUT OVERDRIVES

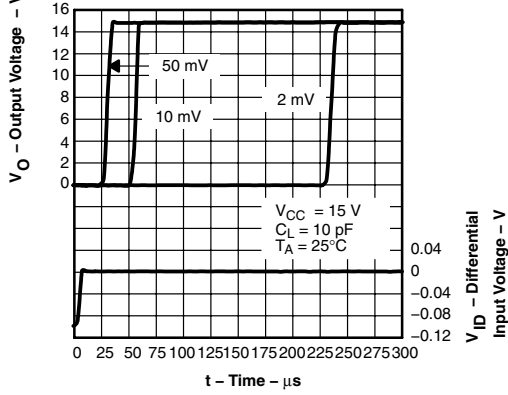

Figure 15

HIGH-TO-LOW LEVEL OUTPUT RESPONSE  
 FOR VARIOUS INPUT OVERDRIVES

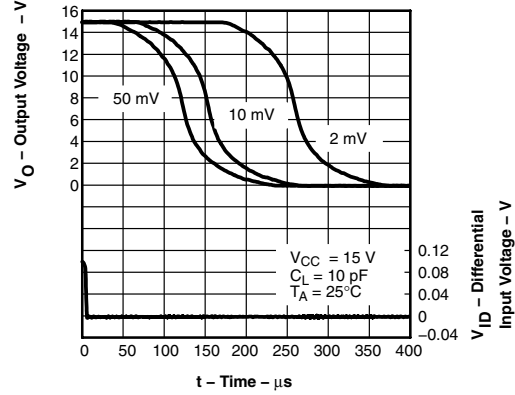

Figure 16

**PACKAGING INFORMATION**

Orderable Device	Status (1)	Package Type	Package Drawing	Pins	Package Qty	Eco Plan (2)	Lead/Ball Finish	MSL Peak Temp (3)	Op Temp (°C)	Top-Side Markings (4)	Samples
TLV3701QDBVRG4Q1	ACTIVE	SOT-23	DBV	5	3000	Green (RoHS & no Sb/Br)	CU NIPDAU	Level-1-260C-UNLIM	-40 to 125	VBCQ	<a href="#">Samples</a>
TLV3701QDBVRQ1	ACTIVE	SOT-23	DBV	5	3000	Green (RoHS & no Sb/Br)	CU NIPDAU	Level-1-260C-UNLIM	-40 to 125	VBCQ	<a href="#">Samples</a>
TLV3702QDRG4Q1	ACTIVE	SOIC	D	8	2500	Green (RoHS & no Sb/Br)	CU NIPDAU	Level-1-260C-UNLIM	-40 to 125	3702Q1	<a href="#">Samples</a>
TLV3702QDRQ1	ACTIVE	SOIC	D	8	2500	Green (RoHS & no Sb/Br)	CU NIPDAU	Level-1-260C-UNLIM	-40 to 125	3702Q1	<a href="#">Samples</a>

(1) The marketing status values are defined as follows:

**ACTIVE:** Product device recommended for new designs.

**LIFEBUY:** TI has announced that the device will be discontinued, and a lifetime-buy period is in effect.

**NRND:** Not recommended for new designs. Device is in production to support existing customers, but TI does not recommend using this part in a new design.

**PREVIEW:** Device has been announced but is not in production. Samples may or may not be available.

**OBSELETE:** TI has discontinued the production of the device.

(2) Eco Plan - The planned eco-friendly classification: Pb-Free (RoHS), Pb-Free (RoHS Exempt), or Green (RoHS & no Sb/Br) - please check <http://www.ti.com/productcontent> for the latest availability information and additional product content details.

**TBD:** The Pb-Free/Green conversion plan has not been defined.

**Pb-Free (RoHS):** TI's terms "Lead-Free" or "Pb-Free" mean semiconductor products that are compatible with the current RoHS requirements for all 6 substances, including the requirement that lead not exceed 0.1% by weight in homogeneous materials. Where designed to be soldered at high temperatures, TI Pb-Free products are suitable for use in specified lead-free processes.

**Pb-Free (RoHS Exempt):** This component has a RoHS exemption for either 1) lead-based flip-chip solder bumps used between the die and package, or 2) lead-based die adhesive used between the die and leadframe. The component is otherwise considered Pb-Free (RoHS compatible) as defined above.

**Green (RoHS & no Sb/Br):** TI defines "Green" to mean Pb-Free (RoHS compatible), and free of Bromine (Br) and Antimony (Sb) based flame retardants (Br or Sb do not exceed 0.1% by weight in homogeneous material)

(3) MSL, Peak Temp. -- The Moisture Sensitivity Level rating according to the JEDEC industry standard classifications, and peak solder temperature.

(4) Multiple Top-Side Markings will be inside parentheses. Only one Top-Side Marking contained in parentheses and separated by a "~" will appear on a device. If a line is indented then it is a continuation of the previous line and the two combined represent the entire Top-Side Marking for that device.

**Important Information and Disclaimer:** The information provided on this page represents TI's knowledge and belief as of the date that it is provided. TI bases its knowledge and belief on information provided by third parties, and makes no representation or warranty as to the accuracy of such information. Efforts are underway to better integrate information from third parties. TI has taken and continues to take reasonable steps to provide representative and accurate information but may not have conducted destructive testing or chemical analysis on incoming materials and chemicals. TI and TI suppliers consider certain information to be proprietary, and thus CAS numbers and other limited information may not be available for release.

In no event shall TI's liability arising out of such information exceed the total purchase price of the TI part(s) at issue in this document sold by TI to Customer on an annual basis.

**OTHER QUALIFIED VERSIONS OF TLV3701-Q1, TLV3702-Q1 :**

- Catalog: [TLV3701](#), [TLV3702](#)
- Enhanced Product: [TLV3701-EP](#)

## NOTE: Qualified Version Definitions:

- Catalog - TI's standard catalog product
- Enhanced Product - Supports Defense, Aerospace and Medical Applications

## TAPE AND REEL INFORMATION



### QUADRANT ASSIGNMENTS FOR PIN 1 ORIENTATION IN TAPE



\*All dimensions are nominal

Device	Package Type	Package Drawing	Pins	SPQ	Reel Diameter (mm)	Reel Width W1 (mm)	A0 (mm)	B0 (mm)	K0 (mm)	P1 (mm)	W (mm)	Pin1 Quadrant
TLV3701QDBVRG4Q1	SOT-23	DBV	5	3000	180.0	9.0	3.15	3.2	1.4	4.0	8.0	Q3
TLV3701QDBVRQ1	SOT-23	DBV	5	3000	180.0	9.0	3.15	3.2	1.4	4.0	8.0	Q3

**TAPE AND REEL BOX DIMENSIONS**



\*All dimensions are nominal

Device	Package Type	Package Drawing	Pins	SPQ	Length (mm)	Width (mm)	Height (mm)
TLV3701QDBVRG4Q1	SOT-23	DBV	5	3000	182.0	182.0	20.0
TLV3701QDBVRQ1	SOT-23	DBV	5	3000	182.0	182.0	20.0

# MECHANICAL DATA

DBV (R-PDSO-G5)

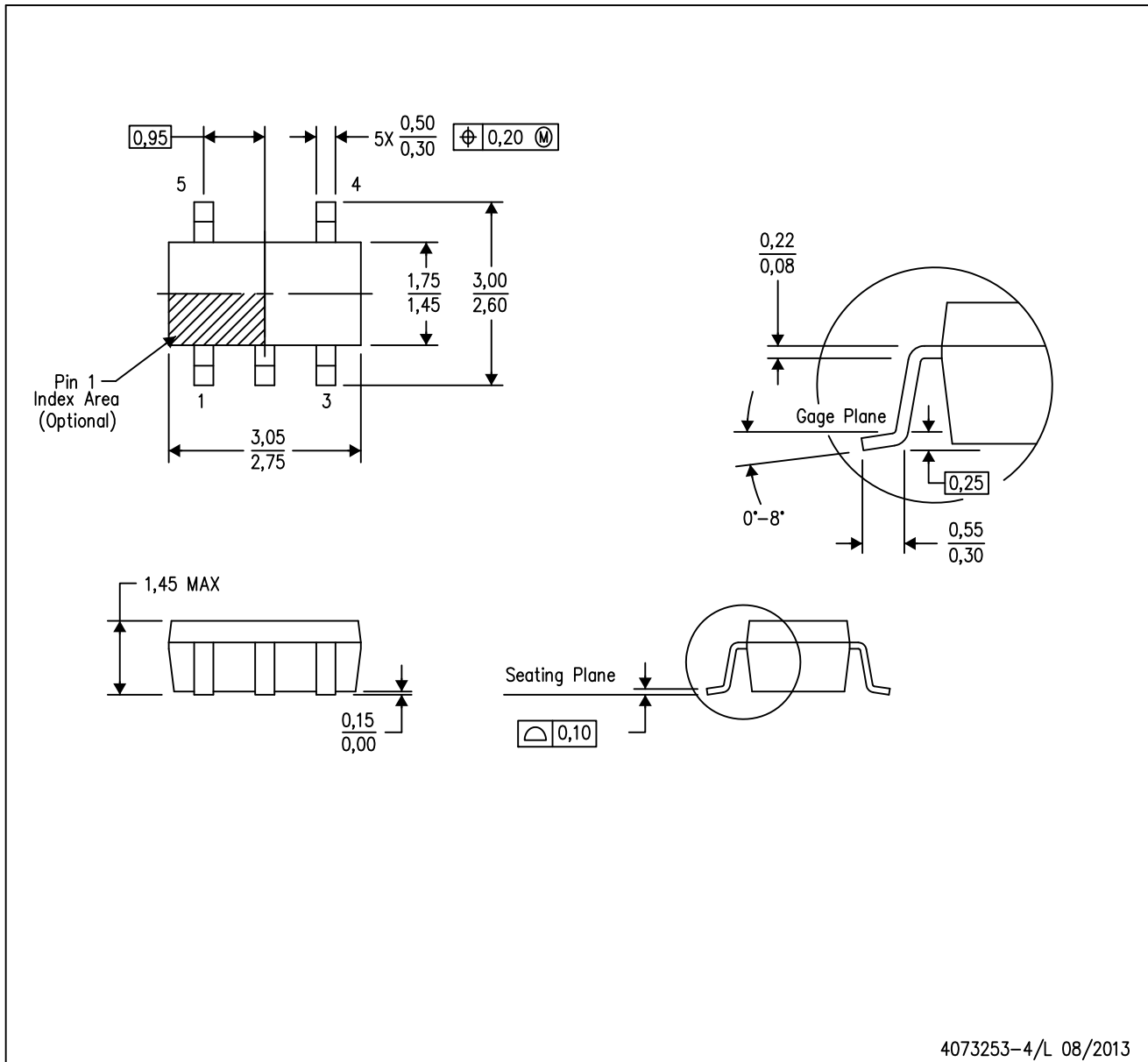
PLASTIC SMALL-OUTLINE PACKAGE



- NOTES:
- A. All linear dimensions are in millimeters.
  - B. This drawing is subject to change without notice.
  - C. Body dimensions do not include mold flash or protrusion. Mold flash and protrusion shall not exceed 0.15 per side.
  - D. Falls within JEDEC MO-178 Variation AA.

DBV (R-PDSO-G5)

PLASTIC SMALL OUTLINE





- NOTES:
- A. All linear dimensions are in millimeters.
  - B. This drawing is subject to change without notice.
  - C. Customers should place a note on the circuit board fabrication drawing not to alter the center solder mask defined pad.
  - D. Publication IPC-7351 is recommended for alternate designs.
  - E. Laser cutting apertures with trapezoidal walls and also rounding corners will offer better paste release. Customers should contact their board assembly site for stencil design recommendations. Example stencil design based on a 50% volumetric metal load solder paste. Refer to IPC-7525 for other stencil recommendations.

D (R-PDSO-G8)

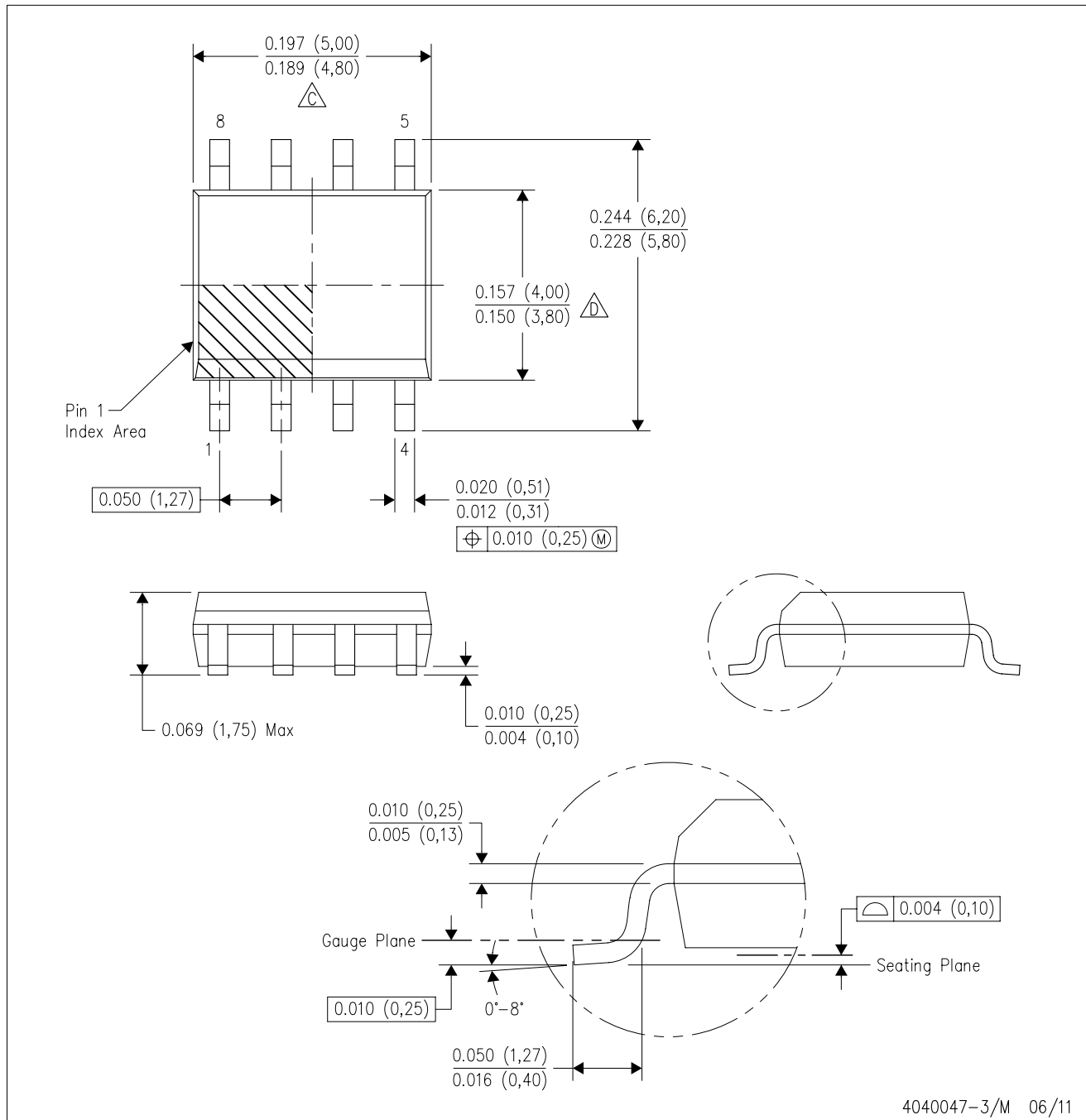
PLASTIC SMALL OUTLINE



- NOTES:
- A. All linear dimensions are in inches (millimeters).
  - B. This drawing is subject to change without notice.
  -  Body length does not include mold flash, protrusions, or gate burrs. Mold flash, protrusions, or gate burrs shall not exceed 0.006 (0,15) each side.
  -  Body width does not include interlead flash. Interlead flash shall not exceed 0.017 (0,43) each side.
  - E. Reference JEDEC MS-012 variation AA.

D (R-PDSO-G8)

PLASTIC SMALL OUTLINE

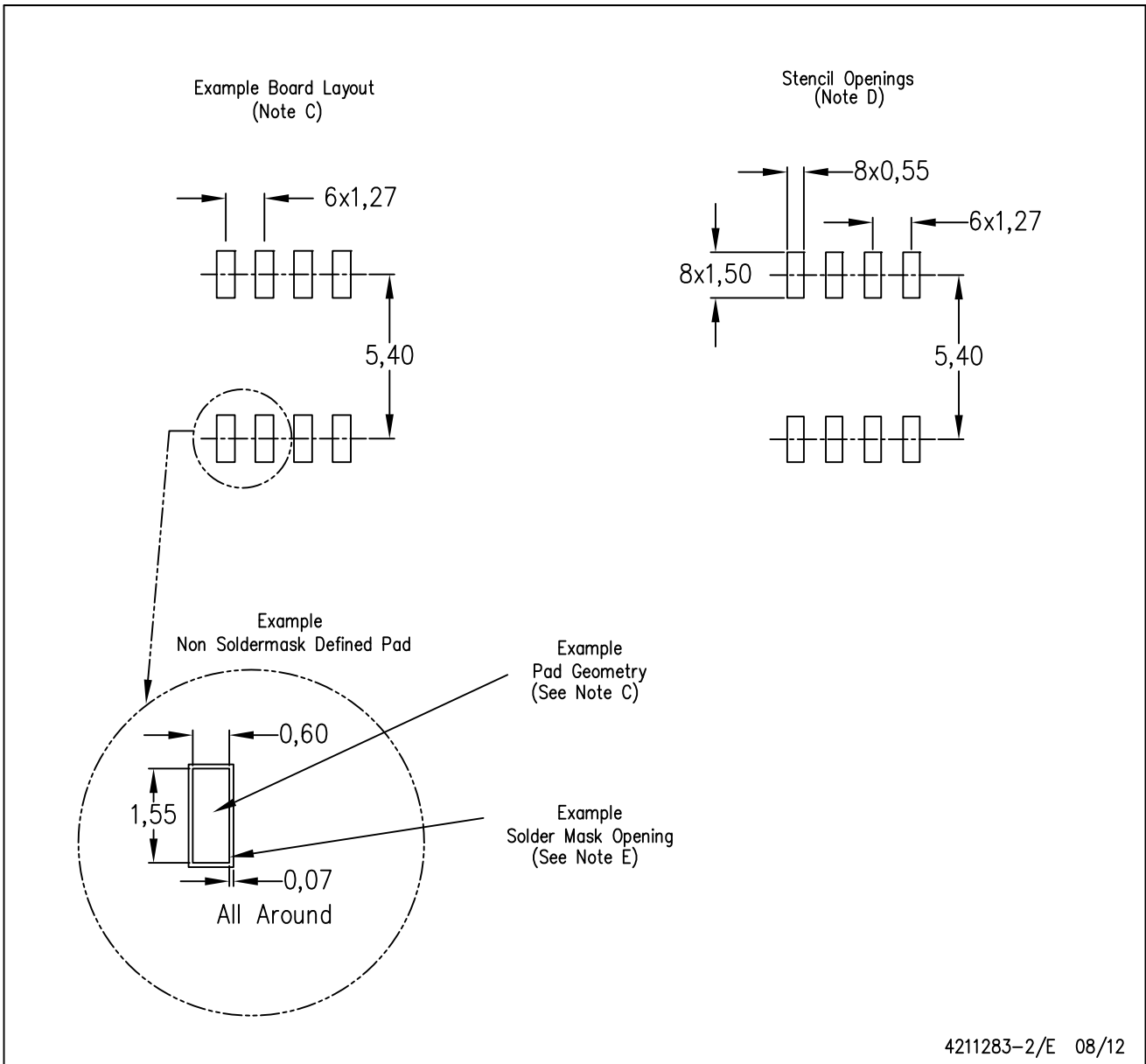

4211283-2/E 08/12

- NOTES:
- A. All linear dimensions are in millimeters.
  - B. This drawing is subject to change without notice.
  - C. Publication IPC-7351 is recommended for alternate designs.
  - D. Laser cutting apertures with trapezoidal walls and also rounding corners will offer better paste release. Customers should contact their board assembly site for stencil design recommendations. Refer to IPC-7525 for other stencil recommendations.
  - E. Customers should contact their board fabrication site for solder mask tolerances between and around signal pads.

## IMPORTANT NOTICE

Texas Instruments Incorporated and its subsidiaries (TI) reserve the right to make corrections, enhancements, improvements and other changes to its semiconductor products and services per JESD46, latest issue, and to discontinue any product or service per JESD48, latest issue. Buyers should obtain the latest relevant information before placing orders and should verify that such information is current and complete. All semiconductor products (also referred to herein as "components") are sold subject to TI's terms and conditions of sale supplied at the time of order acknowledgment.

TI warrants performance of its components to the specifications applicable at the time of sale, in accordance with the warranty in TI's terms and conditions of sale of semiconductor products. Testing and other quality control techniques are used to the extent TI deems necessary to support this warranty. Except where mandated by applicable law, testing of all parameters of each component is not necessarily performed.

TI assumes no liability for applications assistance or the design of Buyers' products. Buyers are responsible for their products and applications using TI components. To minimize the risks associated with Buyers' products and applications, Buyers should provide adequate design and operating safeguards.

TI does not warrant or represent that any license, either express or implied, is granted under any patent right, copyright, mask work right, or other intellectual property right relating to any combination, machine, or process in which TI components or services are used. Information published by TI regarding third-party products or services does not constitute a license to use such products or services or a warranty or endorsement thereof. Use of such information may require a license from a third party under the patents or other intellectual property of the third party, or a license from TI under the patents or other intellectual property of TI.

Reproduction of significant portions of TI information in TI data books or data sheets is permissible only if reproduction is without alteration and is accompanied by all associated warranties, conditions, limitations, and notices. TI is not responsible or liable for such altered documentation. Information of third parties may be subject to additional restrictions.

Resale of TI components or services with statements different from or beyond the parameters stated by TI for that component or service voids all express and any implied warranties for the associated TI component or service and is an unfair and deceptive business practice. TI is not responsible or liable for any such statements.

Buyer acknowledges and agrees that it is solely responsible for compliance with all legal, regulatory and safety-related requirements concerning its products, and any use of TI components in its applications, notwithstanding any applications-related information or support that may be provided by TI. Buyer represents and agrees that it has all the necessary expertise to create and implement safeguards which anticipate dangerous consequences of failures, monitor failures and their consequences, lessen the likelihood of failures that might cause harm and take appropriate remedial actions. Buyer will fully indemnify TI and its representatives against any damages arising out of the use of any TI components in safety-critical applications.

In some cases, TI components may be promoted specifically to facilitate safety-related applications. With such components, TI's goal is to help enable customers to design and create their own end-product solutions that meet applicable functional safety standards and requirements. Nonetheless, such components are subject to these terms.

No TI components are authorized for use in FDA Class III (or similar life-critical medical equipment) unless authorized officers of the parties have executed a special agreement specifically governing such use.

Only those TI components which TI has specifically designated as military grade or "enhanced plastic" are designed and intended for use in military/aerospace applications or environments. Buyer acknowledges and agrees that any military or aerospace use of TI components which have **not** been so designated is solely at the Buyer's risk, and that Buyer is solely responsible for compliance with all legal and regulatory requirements in connection with such use.

TI has specifically designated certain components as meeting ISO/TS16949 requirements, mainly for automotive use. In any case of use of non-designated products, TI will not be responsible for any failure to meet ISO/TS16949.

### Products

Audio	<a href="http://www.ti.com/audio">www.ti.com/audio</a>
Amplifiers	<a href="http://amplifier.ti.com">amplifier.ti.com</a>
Data Converters	<a href="http://dataconverter.ti.com">dataconverter.ti.com</a>
DLP® Products	<a href="http://www.dlp.com">www.dlp.com</a>
DSP	<a href="http://dsp.ti.com">dsp.ti.com</a>
Clocks and Timers	<a href="http://www.ti.com/clocks">www.ti.com/clocks</a>
Interface	<a href="http://interface.ti.com">interface.ti.com</a>
Logic	<a href="http://logic.ti.com">logic.ti.com</a>
Power Mgmt	<a href="http://power.ti.com">power.ti.com</a>
Microcontrollers	<a href="http://microcontroller.ti.com">microcontroller.ti.com</a>
RFID	<a href="http://www.ti-rfid.com">www.ti-rfid.com</a>
OMAP Applications Processors	<a href="http://www.ti.com/omap">www.ti.com/omap</a>
Wireless Connectivity	<a href="http://www.ti.com/wirelessconnectivity">www.ti.com/wirelessconnectivity</a>

### Applications

Automotive and Transportation	<a href="http://www.ti.com/automotive">www.ti.com/automotive</a>
Communications and Telecom	<a href="http://www.ti.com/communications">www.ti.com/communications</a>
Computers and Peripherals	<a href="http://www.ti.com/computers">www.ti.com/computers</a>
Consumer Electronics	<a href="http://www.ti.com/consumer-apps">www.ti.com/consumer-apps</a>
Energy and Lighting	<a href="http://www.ti.com/energy">www.ti.com/energy</a>
Industrial	<a href="http://www.ti.com/industrial">www.ti.com/industrial</a>
Medical	<a href="http://www.ti.com/medical">www.ti.com/medical</a>
Security	<a href="http://www.ti.com/security">www.ti.com/security</a>
Space, Avionics and Defense	<a href="http://www.ti.com/space-avionics-defense">www.ti.com/space-avionics-defense</a>
Video and Imaging	<a href="http://www.ti.com/video">www.ti.com/video</a>

### TI E2E Community

[e2e.ti.com](http://e2e.ti.com)

# AMEYA360

## Components Supply Platform

Authorized Distribution Brand :



Website :

Welcome to visit [www.ameya360.com](http://www.ameya360.com)

Contact Us :

➤ Address :

401 Building No.5, JiuGe Business Center, Lane 2301, Yishan Rd  
Minhang District, Shanghai , China

➤ Sales :

Direct +86 (21) 6401-6692

Email [amall@ameya360.com](mailto:amall@ameya360.com)

QQ 800077892

Skype [ameyasales1](#) [ameyasales2](#)

➤ Customer Service :

Email [service@ameya360.com](mailto:service@ameya360.com)

➤ Partnership :

Tel +86 (21) 64016692-8333

Email [mkt@ameya360.com](mailto:mkt@ameya360.com)