

RP8400 SERIES PUSHBUTTON SWITCH

ANTI-VANDAL SWITCHES
DETECTOR SWITCHES
DIP SWITCHES
KEYLOCK SWITCHES
NAVIGATION SWITCHES
PUSHBUTTON SWITCHES
ROCKER SWITCHES
ROTARY SWITCHES
SLIDE SWITCHES
SNAP ACTION SWITCHES
TACTILE SWITCHES
TOGGLE SWITCHES
CAP OPTIONS

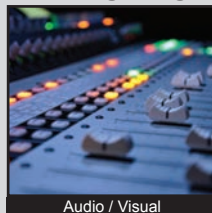

APPLICATIONS / MARKETS



Audio / Visual



Electrical Housewares



Floor Care Appliances

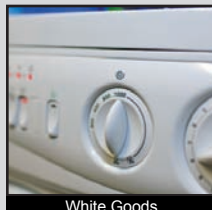

White Goods

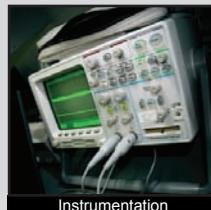

Instrumentation

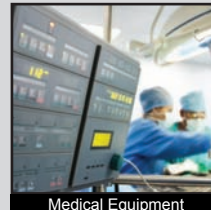

Medical Equipment

RoHS

SPECIFICATIONS

Electrical Rating: 125mA @ 125VAC; 100mA @ 50VDC
Life Expectancy: 500,000 Cycles
Contact Resistance: 50mΩ Max.
Insulation Resistance: 1,000MΩ Min. @ 500VDC
Dielectric Strength: 1,500VAC for 1 minute
Operating Temperature: -30°C to 85°C
Travel: 1.5mm
Contact Arrangement: SPST, Off-(On)
Actuation Force: 350 gf
Panel Thickness: 1.5mm - 4.0mm
Panel Cutout: 13.6mm diameter
Ingress Protection: IP67

FEATURES & BENEFITS

- Threaded mount
- 500,000 life expectancy
- LED illumination options
- Sealed to IP67 ratings
- Metal Diecast housing

PART NUMBER CONFIGURATOR

Series	Bushing	Termination	Contact Material	Seal	Housing Color	Cap Color	LED Color
<input type="text" value="R"/> <input type="text" value="P"/> <input type="text" value="8"/> <input type="text" value="4"/> <input type="text" value="0"/> RP8400	<input type="text" value="B"/> <input type="text" value="2"/> B2 - Threaded (12 x 0.75)	<input type="text" value="M"/> <input type="text" value="1"/> M1 - Standard	<input type="text" value="C"/> C - Gold Over Silver	<input type="text" value="E"/> E - Epoxy Sealed	<input type="text" value="B"/> <input type="text" value="L"/> <input type="text" value="K"/> <input type="text" value="N"/> <input type="text" value="I"/> <input type="text" value="C"/> <input type="text" value="C"/> <input type="text" value="H"/> <input type="text" value="R"/> BLK - Black NIC - Stain Nickel CHR - Chrome	<input type="text" value="W"/> <input type="text" value="H"/> <input type="text" value="T"/> <input type="text" value="B"/> <input type="text" value="L"/> <input type="text" value="K"/> <input type="text" value="R"/> <input type="text" value="E"/> <input type="text" value="D"/> <input type="text" value="O"/> <input type="text" value="R"/> <input type="text" value="G"/> <input type="text" value="Y"/> <input type="text" value="E"/> <input type="text" value="L"/> <input type="text" value="G"/> <input type="text" value="R"/> <input type="text" value="N"/> <input type="text" value="B"/> <input type="text" value="L"/> <input type="text" value="U"/> WHT - White BLK - Black RED - Red ORG - Orange YEL - Yellow GRN - Green BLU - Blue	<input type="text" value="W"/> <input type="text" value="H"/> <input type="text" value="T"/> <input type="text" value="R"/> <input type="text" value="E"/> <input type="text" value="D"/> <input type="text" value="Y"/> <input type="text" value="E"/> <input type="text" value="L"/> <input type="text" value="G"/> <input type="text" value="R"/> <input type="text" value="N"/> <input type="text" value="B"/> <input type="text" value="L"/> <input type="text" value="U"/> <input type="text" value="N"/> <input type="text" value="I"/> <input type="text" value="L"/> WHT - White LED RED - Red LED YEL - Yellow LED GRN - Green LED BLU - Blue LED NIL - Non Illuminated

Specifications subject to change without notice



E-SWITCH®

www.e-switch.com

800.867.2717

2

RP8400 SERIES PUSHBUTTON SWITCH

Body Dimensions

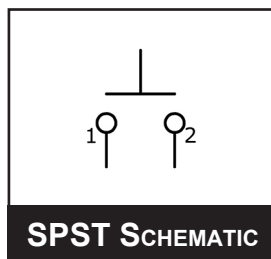
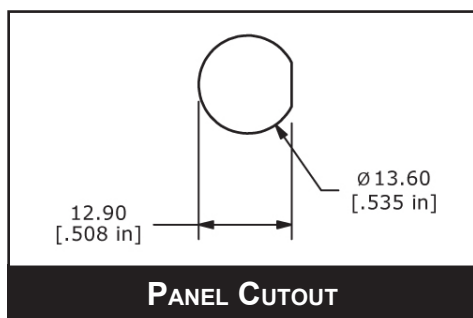
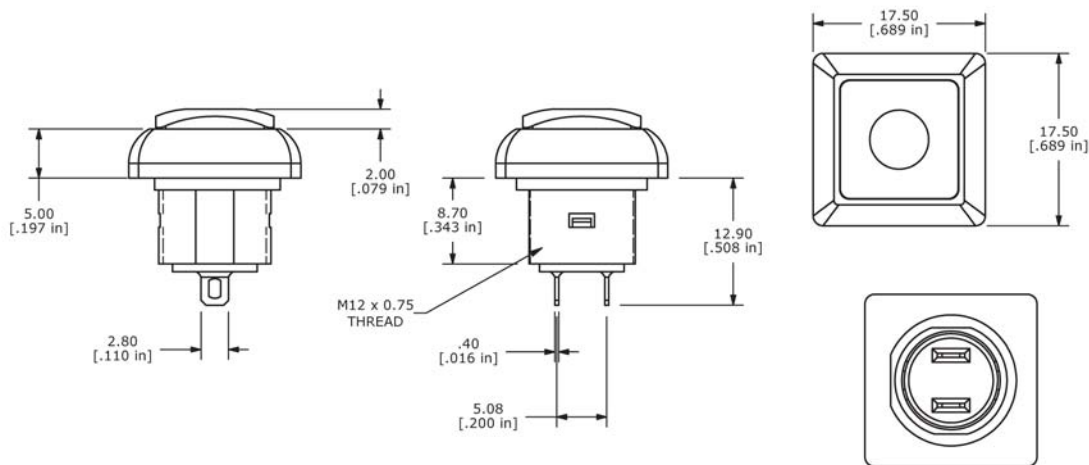

AMEYA360

Components Supply Platform

Authorized Distribution Brand :



Website :

Welcome to visit www.ameya360.com

Contact Us :

➤ Address :

401 Building No.5, JiuGe Business Center, Lane 2301, Yishan Rd
Minhang District, Shanghai , China

➤ Sales :

Direct +86 (21) 6401-6692

Email amall@ameya360.com

QQ 800077892

Skype [ameyasales1](#) [ameyasales2](#)

➤ Customer Service :

Email service@ameya360.com

➤ Partnership :

Tel +86 (21) 64016692-8333

Email mkt@ameya360.com