

# LMV821, LMV824

## Single and Quad Low Voltage, Rail-to-Rail Operational Amplifiers

The LMV821 and LMV824 are operational amplifiers with low input voltage offset and drift vs. temperature. In spite of low quiescent current requirements these devices have 5 MHz bandwidth and 1.4 V/ $\mu$ s slew rate. In addition they provide rail-to-rail output swing into 600  $\Omega$  loads. The input common-mode voltage range includes ground, and the maximum input offset voltage is only 3.5 mV. Substantially large capacitive loads can be driven by simply adding a pullup resistor or isolation resistor.

The LMV821 (single) is available in a space-saving SC70-5 while the quad comes in SOIC and TSSOP packages.

### Features

- Low Offset Voltage: 3.5 mV
- Very low Offset Drift: 1.0  $\mu$ V/ $^{\circ}$ C
- High Bandwidth: 5 MHz
- Rail-to-Rail Output Swing into a 600  $\Omega$  load
- Capable of driving highly capacitive loads
- Small Packages:
  - LMV821 in SC-70
  - LMV824 in SOIC-14 and TSSOP-14
- These Devices are Pb-Free and are RoHS Compliant

### Typical Applications

- Notebook Computers
- PDAs
- Modem Transmitter/ Receivers

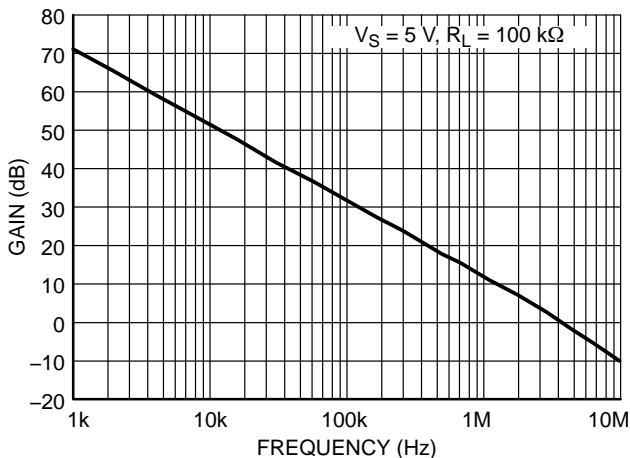

Figure 1. Gain vs. Frequency

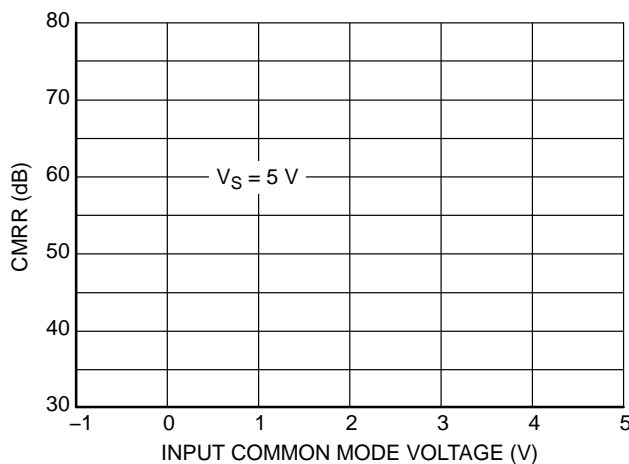

Figure 2. CMRR vs. Input Common Mode Voltage



ON Semiconductor®

[www.onsemi.com](http://www.onsemi.com)



SC-70  
CASE 419A



SOIC-14  
CASE 751A

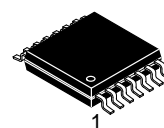

TSSOP-14  
CASE 948G

### ORDERING AND MARKING INFORMATION

See detailed ordering, marking and shipping information in the package dimensions section on page 2 of this data sheet.

# LMV821, LMV824

## MARKING DIAGRAMS

### SC-70

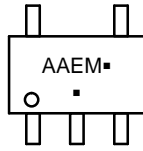

AAE = Specific Device Code  
 M = Date Code  
 ■ = Pb-Free Package

(Note: Microdot may be in either location)

### SOIC-14

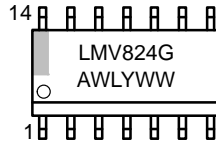

LMV824 = Specific Device Code  
 A = Assembly Location  
 WL = Wafer Lot  
 Y = Year  
 WW = Work Week  
 G = Pb-Free Package

### TSSOP-14

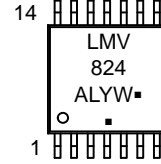

LMV824 = Specific Device Code  
 A = Assembly Location  
 L = Wafer Lot  
 Y = Year  
 W = Work Week  
 ■ = Pb-Free Package

(Note: Microdot may be in either location)

## PIN CONNECTIONS

### SC70-5

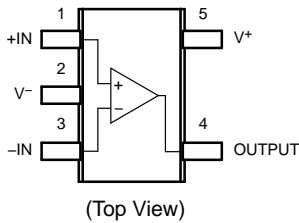

### SOIC-14

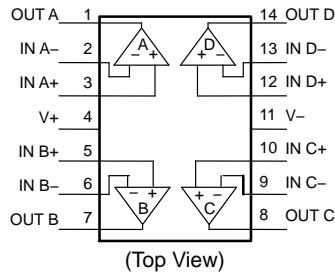

### TSSOP-14

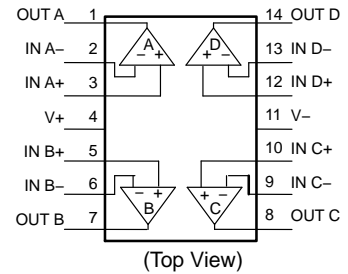

## ORDERING INFORMATION

Order Number	Number of Channels	Specific Device Marking	Package Type	Shipping†
LMV821SQ3T2G	Single	AAE	SC-70 (Pb-Free)	3000 / Tape & Reel
LMV824DR2G	Quad	LMV824	SOIC-14 (Pb-Free)	2500 / Tape & Reel
LMV824DTBR2G	Quad	LMV 824	TSSOP-14 (Pb-Free)	2500 / Tape & Reel

†For information on tape and reel specifications, including part orientation and tape sizes, please refer to our Tape and Reel Packaging Specifications Brochure, BRD8011/D.

# LMV821, LMV824

## MAXIMUM RATINGS

Symbol	Rating	Value	Unit
V <sub>S</sub>	Supply Voltage (Operating Range V <sub>S</sub> = 2.7 V to 5.5 V)	5.5	V
V <sub>IDR</sub>	Input Differential Voltage	± Supply Voltage	V
V <sub>ICR</sub>	Input Common Mode Voltage Range	-0.5 to (V+) +0.5	V
	Maximum Input Current	10	mA
t <sub>SO</sub>	Output Short Circuit (Note 1)	Continuous	
T <sub>J</sub>	Maximum Junction Temperature (Operating Range -40°C to 85°C)	150	°C
θ <sub>JA</sub>	Thermal Resistance		°C/W
	SC-70	280	
	SOIC-14	156	
	TSSOP-14	190	
T <sub>STG</sub>	Storage Temperature	-65 to 150	°C
	Mounting Temperature (Infrared or Convection – 20 sec)	235	°C
V <sub>ESD</sub>	ESD Tolerance	Machine Model	200
		Human Body Model	2000

Stresses exceeding those listed in the Maximum Ratings table may damage the device. If any of these limits are exceeded, device functionality should not be assumed, damage may occur and reliability may be affected.

1. Continuous short-circuit operation to ground at elevated ambient temperature can result in exceeding the maximum allowed junction temperature of 150°C. Output currents in excess of 45 mA over long term may adversely affect reliability. Shorting output to either V+ or V- will adversely affect reliability.

## LMV821, LMV824

**2.7V DC ELECTRICAL CHARACTERISTICS** Unless otherwise noted, all min/max limits are guaranteed for  $T_A = 25^\circ\text{C}$ ,  $V_+ = 2.7\text{ V}$ ,  $V_- = 0\text{ V}$ ,  $V_{CM} = V_+/2$ ,  $V_O = V_+/2$  and  $R_L > 1\text{ M}\Omega$ . Typical specifications represent the most likely parametric norm. Min/Max specifications are guaranteed by testing, characterization, or statistical analysis.

Parameter	Symbol	Conditions	Min	Typ	Max	Unit
Input Offset Voltage	$V_{IO}$			1	3.5	mV
		$T_A = -40^\circ\text{C to } +85^\circ\text{C}$			4	
Input Offset Voltage Average Drift	$TCV_{OS}$			1		$\mu\text{V}/^\circ\text{C}$
Input Bias Current	$I_B$			105	210	nA
		$T_A = -40^\circ\text{C to } +85^\circ\text{C}$			315	
Input Offset Current	$I_{IO}$			0.5	30	nA
		$T_A = -40^\circ\text{C to } +85^\circ\text{C}$			50	
Common-Mode Rejection Ratio	CMRR	$0\text{ V} \leq V_{CM} \leq 1.7\text{ V}$	70	85		dB
		$T_A = -40^\circ\text{C to } +85^\circ\text{C}$	68			
Power Supply Rejection Ratio	PSRR	$1.5\text{ V} \leq V_+ \leq 4\text{ V}$ , $V_- = -1\text{ V}$ , $V_O = 0\text{ V}$ , $V_{CM} = 0.0\text{ V}$	75	85		dB
		$T_A = -40^\circ\text{C to } +85^\circ\text{C}$	70			
Input Common-Mode Voltage Range	$V_{CM}$	For CMRR $\geq 53\text{ dB}$ and $T_A = -40^\circ\text{C to } +85^\circ\text{C}$	-0.2	-0.3 to 2.0	1.9	V
Large Signal Voltage Gain	AV	$R_L = 600\ \Omega$ , $V_O = 0.5\text{ V to } 2.5\text{ V}$	80	95		dB
		$T_A = -40^\circ\text{C to } +85^\circ\text{C}$	70			
		$R_L = 2\text{ k}\Omega$ , $V_O = 0.5\text{ V to } 2.5\text{ V}$	83	89		
		$T_A = -40^\circ\text{C to } +85^\circ\text{C}$	80			
Output Swing	$V_{OH}$	$R_L = 600\ \Omega$ to $1.35\text{ V}$	2.5	2.58		V
		$T_A = -40^\circ\text{C to } +85^\circ\text{C}$	2.4			
	$V_{OL}$	$R_L = 600\ \Omega$ to $1.35\text{ V}$		0.13	0.21	
		$T_A = -40^\circ\text{C to } +85^\circ\text{C}$			0.3	
	$V_{OH}$	$R_L = 2\text{ k}\Omega$ to $1.35\text{ V}$	2.6	2.66		
		$T_A = -40^\circ\text{C to } +85^\circ\text{C}$	2.5			
Output Current	$I_O$	Sourcing, $V_O = 0\text{ V}$	12			mA
		Sinking, $V_O = 2.7\text{ V}$	12	26		
Supply Current	$I_{CC}$	LMV821 (Single)		0.242	0.3	mA
		$T_A = -40^\circ\text{C to } +85^\circ\text{C}$			0.5	
		LMV824 (All Four Channels)		1	1.3	
		$T_A = -40^\circ\text{C to } +85^\circ\text{C}$			1.5	

## LMV821, LMV824

**2.5V DC ELECTRICAL CHARACTERISTICS** Unless otherwise noted, all min/max limits are guaranteed for  $T_A = 25^\circ\text{C}$ ,  $V_+ = 2.5\text{ V}$ ,  $V_- = 0\text{ V}$ ,  $V_{CM} = V_+/2$ ,  $V_O = V_+/2$  and  $R_L > 1\text{ M}\Omega$ . Typical specifications represent the most likely parametric norm. Min/Max specifications are guaranteed by testing, characterization, or statistical analysis.

Parameter	Symbol	Conditions	Min	Typ	Max	Unit
Input Offset Voltage	$V_{IO}$	$T_A = -40^\circ\text{C to } +85^\circ\text{C}$		1	3.5	mV
					4	
Output Swing	$V_{OH}$	$R_L = 600\ \Omega \text{ to } 1.25\text{ V}$	2.3	2.37		V
		$T_A = -40^\circ\text{C to } +85^\circ\text{C}$	2.2			
	$V_{OL}$	$R_L = 600\ \Omega \text{ to } 1.25\text{ V}$		0.13	0.20	
		$T_A = -40^\circ\text{C to } +85^\circ\text{C}$			0.3	
	$V_{OH}$	$R_L = 2\text{ k}\Omega \text{ to } 1.25\text{ V}$	2.4	2.46		
		$T_A = -40^\circ\text{C to } +85^\circ\text{C}$	2.3			
	$V_{OL}$	$R_L = 2\text{ k}\Omega \text{ to } 1.25\text{ V}$		0.08	0.12	
		$T_A = -40^\circ\text{C to } +85^\circ\text{C}$			0.20	

**2.7V AC ELECTRICAL CHARACTERISTICS** Unless otherwise specified, all limits are guaranteed for  $T_A = 25^\circ\text{C}$ ,  $V_+ = 2.7\text{ V}$ ,  $V_- = 0\text{ V}$ ,  $V_{CM} = 1.0\text{ V}$ ,  $V_O = V_+/2$  and  $R_L > 1\text{ M}\Omega$ . Typical specifications represent the most likely parametric norm. Min/Max specifications are guaranteed by testing, characterization, or statistical analysis.

Parameter	Symbol	Conditions	Min	Typ	Max	Unit
Slew Rate	SR	(Note 2)		1.5		V/ $\mu\text{S}$
Gain Bandwidth Product	GBWP			5		MHz
Phase Margin	$\theta_m$			55		$^\circ$
Gain Margin	$G_m$			12.9		dB
Input-Referred Voltage Noise	$e_n$	$f = 1\text{ kHz}, V_{CM} = 1\text{ V}$		12		nV/ $\sqrt{\text{Hz}}$
Input-Referred Current Noise	$i_n$	$f = 1\text{ kHz}$		0.2		pA/ $\sqrt{\text{Hz}}$
Total Harmonic Distortion	THD	$f = 1\text{ kHz}, AV = -2, R_L = 10\text{ k}\Omega, V_O = 1.8\text{ V}_{PP}$		0.023		%
Amplifier-to-Amplifier Isolation		(Note 3)		135		dB

2. Connected as voltage follower with input step from 0.5 V to 1.5 V. Number specified is the average of the positive and negative slew rates.
3. Input referred,  $R_L = 100\text{ k}\Omega$  connected to  $V_+/2$ . Each amp excited in turn with 1kHz to produce  $V_O = 3\text{ V}_{PP}$ . For Supply Voltages  $< 3\text{ V}$ ,  $V_O = V_+$ .

## LMV821, LMV824

**5V DC ELECTRICAL CHARACTERISTICS** Unless otherwise noted, all min/max limits are guaranteed for  $T_A = 25^\circ\text{C}$ ,  $V_+ = 5\text{ V}$ ,  $V_- = 0\text{ V}$ ,  $V_{CM} = V_+/2$ ,  $V_O = V_+/2$  and  $R_L > 1\text{ M}\Omega$ . Typical specifications represent the most likely parametric norm. Min/Max specifications are guaranteed by testing, characterization, or statistical analysis.

Parameter	Symbol	Conditions	Min	Typ	Max	Unit
Input Offset Voltage	$V_{IO}$			1	3.5	mV
		$T_A = -40^\circ\text{C}$ to $+85^\circ\text{C}$			4	
Input Offset Voltage Average Drift	$TCV_{OS}$			1		$\mu\text{V}/^\circ\text{C}$
Input Bias Current	$I_B$			119	245	nA
		$T_A = -40^\circ\text{C}$ to $+85^\circ\text{C}$			380	
Input Offset Current	$I_{IO}$			0.5	30	nA
		$T_A = -40^\circ\text{C}$ to $+85^\circ\text{C}$			50	
Common-Mode Rejection Ratio	CMRR	$0\text{ V} \leq V_{CM} \leq 4.0\text{ V}$	72	90		dB
		$T_A = -40^\circ\text{C}$ to $+85^\circ\text{C}$	70			
Power Supply Rejection Ratio	PSRR	$1.7\text{ V} \leq V_+ \leq 4\text{ V}$ , $V_- = 1\text{ V}$ , $V_O = 0\text{ V}$ , $V_{CM} = 0.0\text{ V}$	75	85		dB
		$T_A = -40^\circ\text{C}$ to $+85^\circ\text{C}$	70			
Input Common-Mode Voltage Range	$V_{CM}$	For CMRR $\geq 58\text{ dB}$ and $T_A = -40^\circ\text{C}$ to $+85^\circ\text{C}$	-0.2	-0.2 to 4.3	4.2	V
Large Signal Voltage Gain	$A_V$	$R_L = 600\ \Omega$ , $V_O = 1.0\text{ V}$ to $4.0\text{ V}$	87	100		dB
		$T_A = -40^\circ\text{C}$ to $+85^\circ\text{C}$	73			
		$R_L = 2\text{ k}\Omega$ , $V_O = 1.0\text{ V}$ to $4.0\text{ V}$	84	99		
		$T_A = -40^\circ\text{C}$ to $+85^\circ\text{C}$	82			
Output Swing	$V_{OH}$	$R_L = 600\ \Omega$ to $2.5\text{ V}$	4.75	4.84		V
		$T_A = -40^\circ\text{C}$ to $+85^\circ\text{C}$	4.7			
	$V_{OL}$	$R_L = 600\ \Omega$ to $2.5\text{ V}$		0.17	0.33	
		$T_A = -40^\circ\text{C}$ to $+85^\circ\text{C}$			0.4	
	$V_{OH}$	$R_L = 2\text{ k}\Omega$ to $2.5\text{ V}$	4.85	4.9		
		$T_A = -40^\circ\text{C}$ to $+85^\circ\text{C}$	4.8			
Output Current	$I_O$	Sourcing, $V_O = 0\text{ V}$	20	45		mA
		$T_A = -40^\circ\text{C}$ to $+85^\circ\text{C}$	10			
		Sinking, $V_O = 5\text{ V}$	20	40		
		$T_A = -40^\circ\text{C}$ to $+85^\circ\text{C}$	15			
Supply Current	$I_{CC}$			0.3	0.4	mA
		$T_A = -40^\circ\text{C}$ to $+85^\circ\text{C}$			0.6	
		LMV822 (Both Applications)		0.5	0.7	
		$T_A = -40^\circ\text{C}$ to $+85^\circ\text{C}$			0.9	
		LMV824 (All Four Applications)		1	1.3	
		$T_A = -40^\circ\text{C}$ to $+85^\circ\text{C}$			1.5	

## LMV821, LMV824

**5V AC ELECTRICAL CHARACTERISTICS** Unless otherwise specified, all limits are guaranteed for  $T_A = 25^\circ\text{C}$ ,  $V_+ = 5\text{ V}$ ,  $V_- = 0\text{ V}$ ,  $V_{CM} = 2.0\text{ V}$ ,  $V_O = V_+/2$  and  $R_L > 1\text{ M}\Omega$ . Typical specifications represent the most likely parametric norm. Min/Max specifications are guaranteed by testing, characterization, or statistical analysis.

Parameter	Symbol	Conditions	Min	Typ	Max	Unit
Slew Rate	SR	(Note 4)		2		V/ $\mu\text{S}$
Gain Bandwidth Product	GBWP			5.6		MHz
Phase Margin	$\theta_m$			63		$^\circ$
Gain Margin	$G_m$			11.7		dB
Input-Referred Voltage Noise	$e_n$	$f = 1\text{ kHz}$ , $V_{CM} = 1\text{ V}$		11		nV/ $\sqrt{\text{Hz}}$
Input-Referred Current Noise	$i_n$	$f = 1\text{ kHz}$		0.21		pA/ $\sqrt{\text{Hz}}$
Total Harmonic Distortion	THD	$f = 1\text{ kHz}$ , $A_V = -2$ , $R_L = 10\text{ k}\Omega$ , $V_O = 4.11\text{ VPP}$		0.012		%
Amplifier-to-Amplifier Isolation		(Note 5)		135		dB

4. Connected as voltage follower with input step from 0.5 V to 3.5 V. Number specified is the average of the positive and negative slew rates.
5. Input referred,  $R_L = 100\text{ k}\Omega$  connected to  $V_+/2$ . Each amp excited in turn with 1 kHz to produce  $V_O = 3\text{ VPP}$ . (For Supply Voltages  $< 3\text{ V}$ ,  $V_O = V_+$ ).

TYPICAL PERFORMANCE CHARACTERISTICS

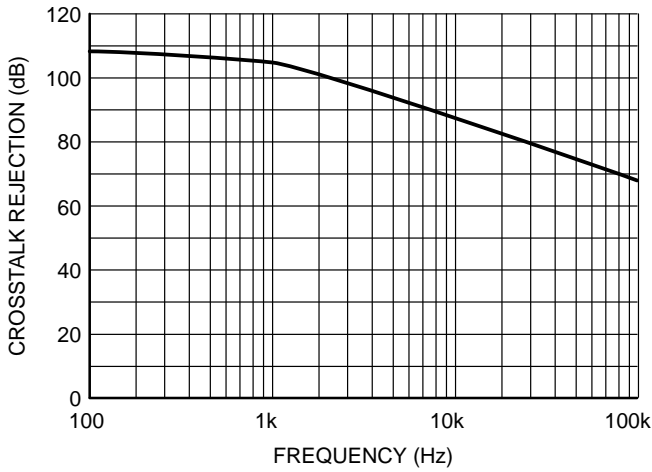

Figure 3. Crosstalk Rejection vs. Frequency

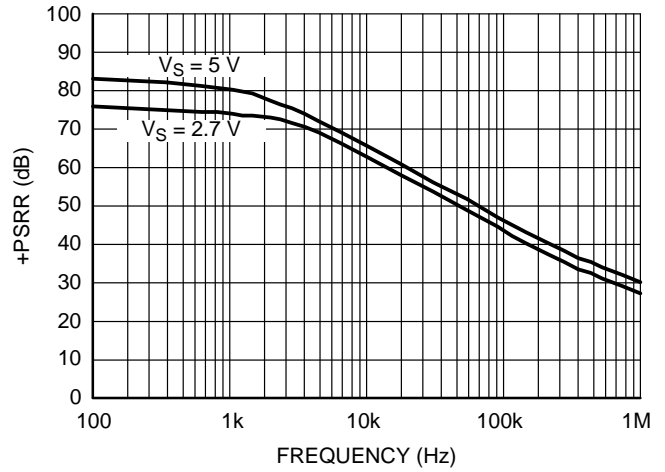

Figure 4. +PSRR vs. Frequency

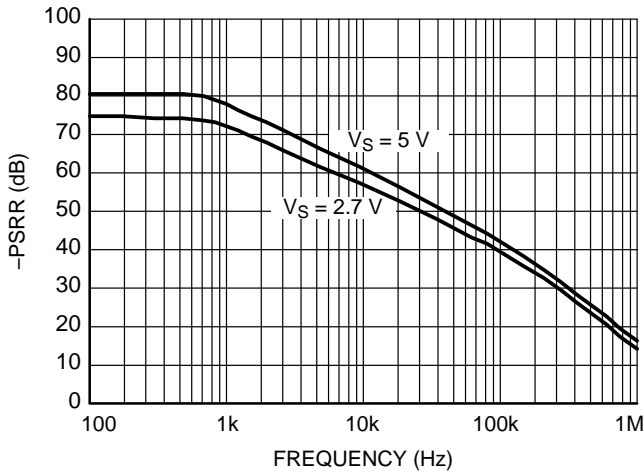

Figure 5. -PSRR vs. Frequency

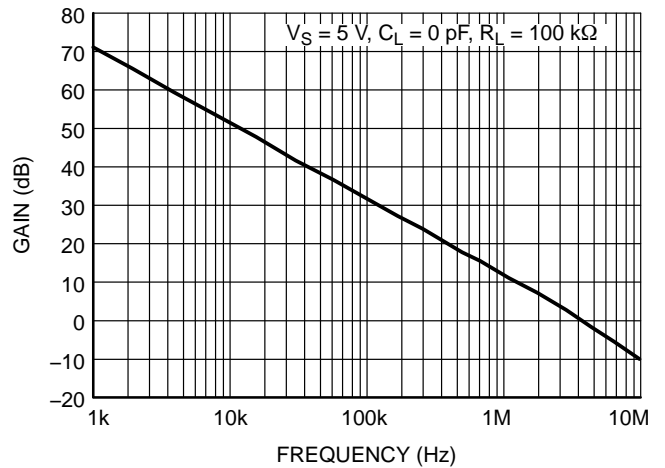

Figure 6. Gain vs. Frequency

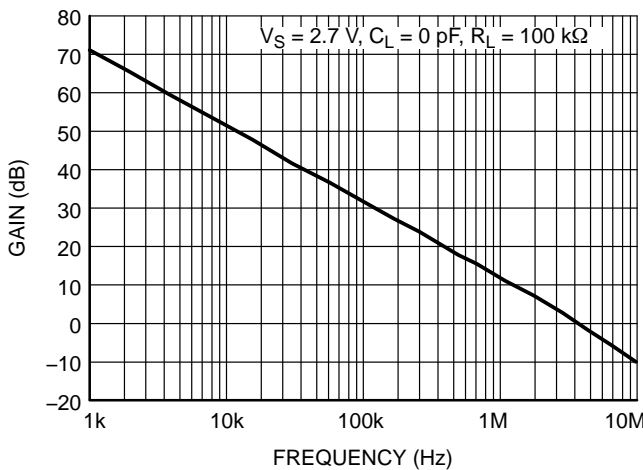

Figure 7. Gain vs. Frequency

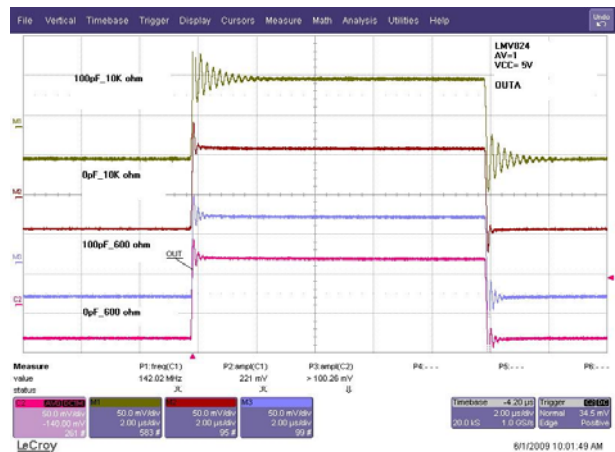

Figure 8. Non-Inverting Stability vs. Capacitive Load



# LMV821, LMV824

## TYPICAL PERFORMANCE CHARACTERISTICS

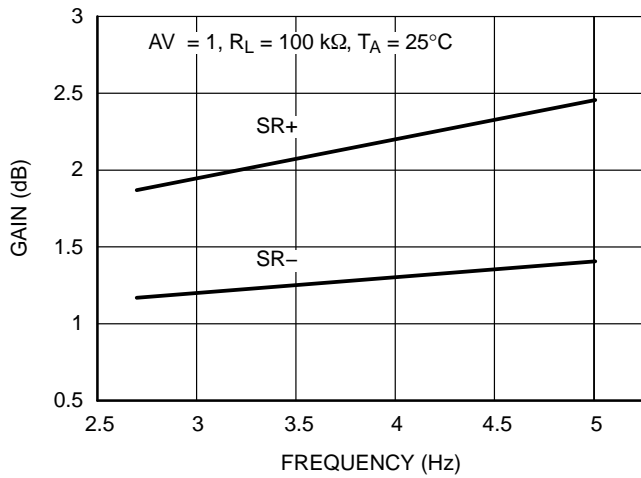

Figure 9. Gain vs. Frequency



Figure 10. Non-Inverting Large Signal Step Response

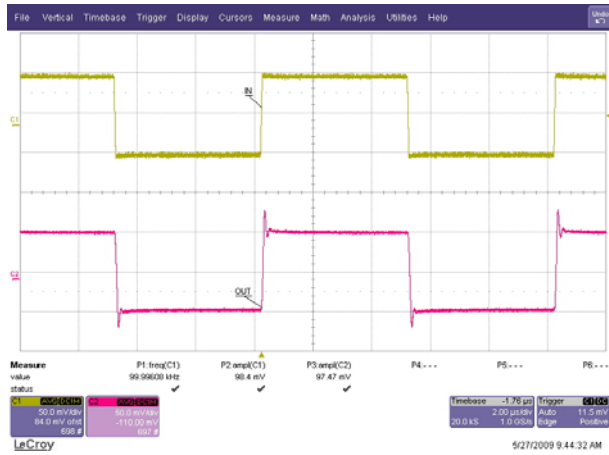

Figure 11. Non-Inverting Small Signal Step Response

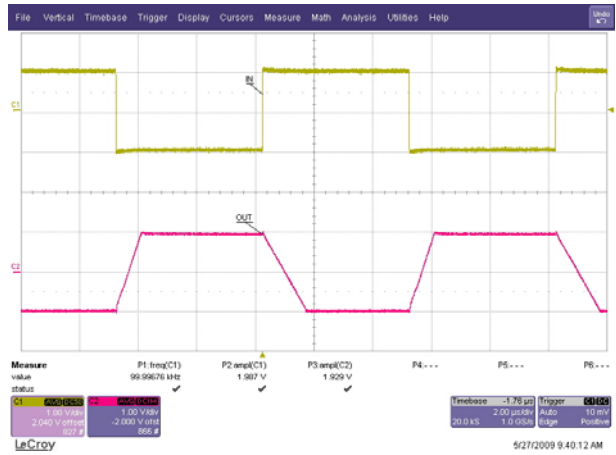

Figure 12. Inverting Large Signal Step Response

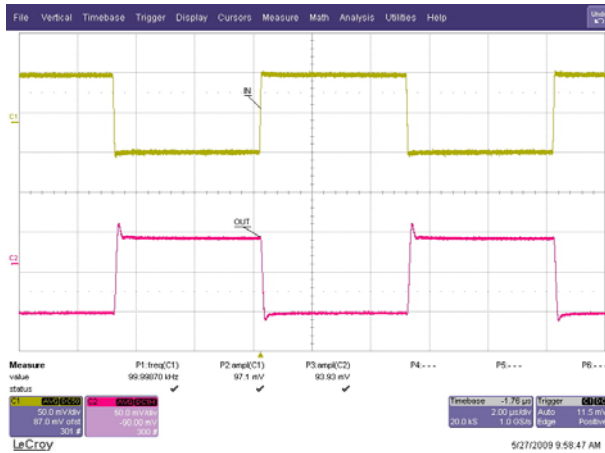

Figure 13. Inverting Small Signal Step Response

# LMV821, LMV824

## APPLICATIONS INFORMATION

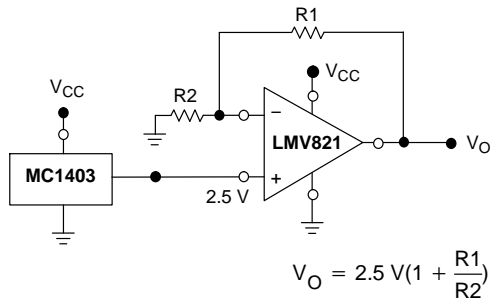

Figure 14. Voltage Reference

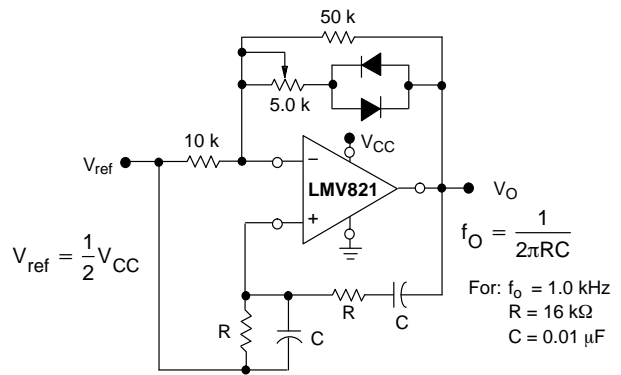

Figure 15. Wien Bridge Oscillator

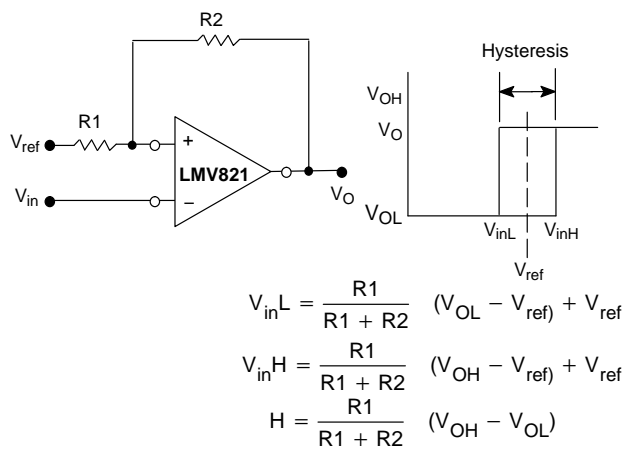
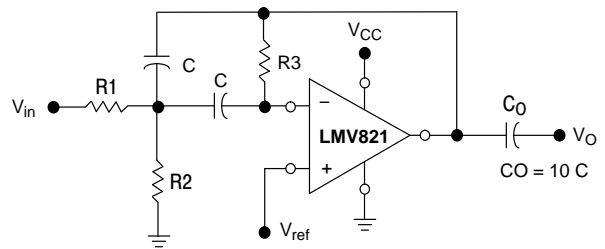

Figure 16. Comparator with Hysteresis



Given:  $f_o$  = center frequency  
 $A(f_o)$  = gain at center frequency

Choose value  $f_o, C$

$$\text{Then: } R_3 = \frac{Q}{\pi f_o C}$$

$$R_1 = \frac{R_3}{2 A(f_o)}$$

$$R_2 = \frac{R_1 R_3}{4Q^2 R_1 - R_3}$$

For less than 10% error from operational amplifier,  
 $((Q_o f_o)/BW) < 0.1$  where  $f_o$  and  $BW$  are expressed in Hz.  
 If source impedance varies, filter may be preceded with  
 voltage follower buffer to stabilize filter parameters.

Figure 17. Multiple Feedback Bandpass Filter

# LMV821, LMV824

## PACKAGE DIMENSIONS

SC-88A (SC-70-5/SOT-353)

CASE 419A-02

ISSUE L

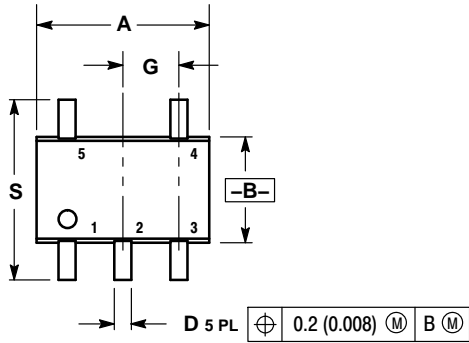

NOTES:

1. DIMENSIONING AND TOLERANCING PER ANSI Y14.5M, 1982.
2. CONTROLLING DIMENSION: INCH.
3. 419A-01 OBSOLETE. NEW STANDARD 419A-02.
4. DIMENSIONS A AND B DO NOT INCLUDE MOLD FLASH, PROTRUSIONS, OR GATE BURRS.

DIM	INCHES		MILLIMETERS	
	MIN	MAX	MIN	MAX
A	0.071	0.087	1.80	2.20
B	0.045	0.053	1.15	1.35
C	0.031	0.043	0.80	1.10
D	0.004	0.012	0.10	0.30
G	0.026 BSC		0.65 BSC	
H	---	0.004	---	0.10
J	0.004	0.010	0.10	0.25
K	0.004	0.012	0.10	0.30
N	0.008 REF		0.20 REF	
S	0.079	0.087	2.00	2.20

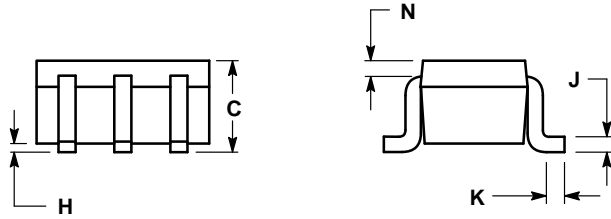

### SOLDER FOOTPRINT

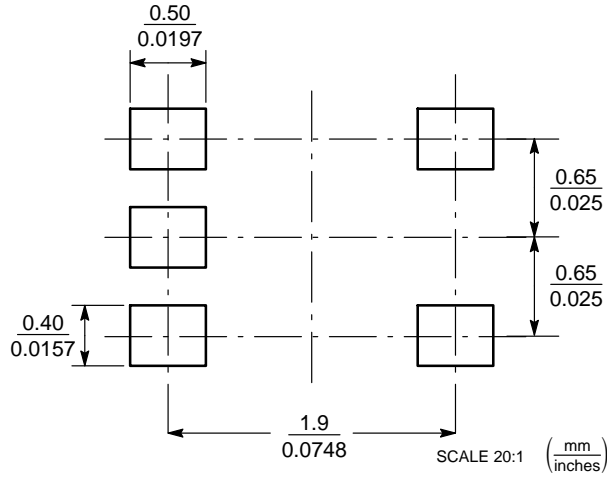

# LMV821, LMV824

## PACKAGE DIMENSIONS

SOIC-14  
CASE 751A-03  
ISSUE K

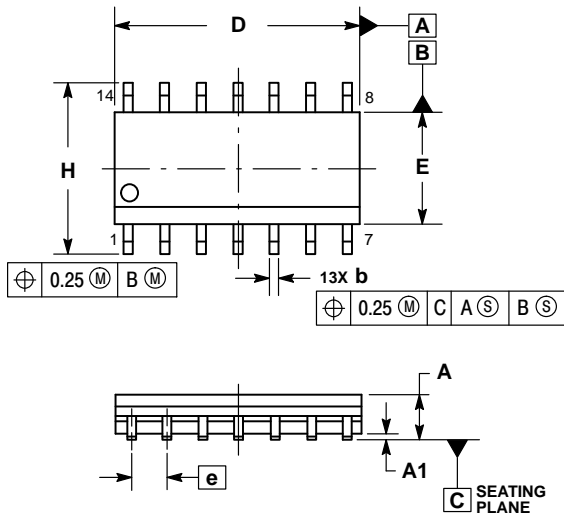

NOTES:

1. DIMENSIONING AND TOLERANCING PER ASME Y14.5M, 1994.
2. CONTROLLING DIMENSION: MILLIMETERS.
3. DIMENSION b DOES NOT INCLUDE DAMBAR PROTRUSION. ALLOWABLE PROTRUSION SHALL BE 0.13 TOTAL IN EXCESS OF AT MAXIMUM MATERIAL CONDITION.
4. DIMENSIONS D AND E DO NOT INCLUDE MOLD PROTRUSIONS.
5. MAXIMUM MOLD PROTRUSION 0.15 PER SIDE.

DIM	MILLIMETERS		INCHES	
	MIN	MAX	MIN	MAX
A	1.35	1.75	0.054	0.068
A1	0.10	0.25	0.004	0.010
A3	0.19	0.25	0.008	0.010
b	0.35	0.49	0.014	0.019
D	8.55	8.75	0.337	0.344
E	3.80	4.00	0.150	0.157
e	1.27 BSC		0.050 BSC	
H	5.80	6.20	0.228	0.244
h	0.25	0.50	0.010	0.019
L	0.40	1.25	0.016	0.049
M	0°	7°	0°	7°

### SOLDERING FOOTPRINT\*

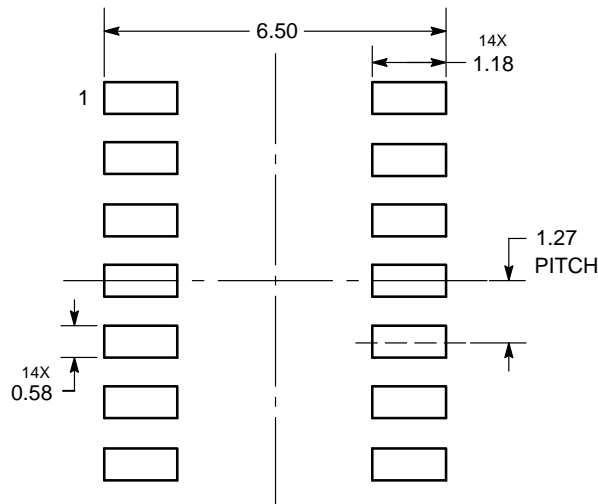

DIMENSIONS: MILLIMETERS

\*For additional information on our Pb-Free strategy and soldering details, please download the ON Semiconductor Soldering and Mounting Techniques Reference Manual, SOLDERRM/D.

# LMV821, LMV824

## PACKAGE DIMENSIONS

### TSSOP-14 CASE 948G ISSUE B

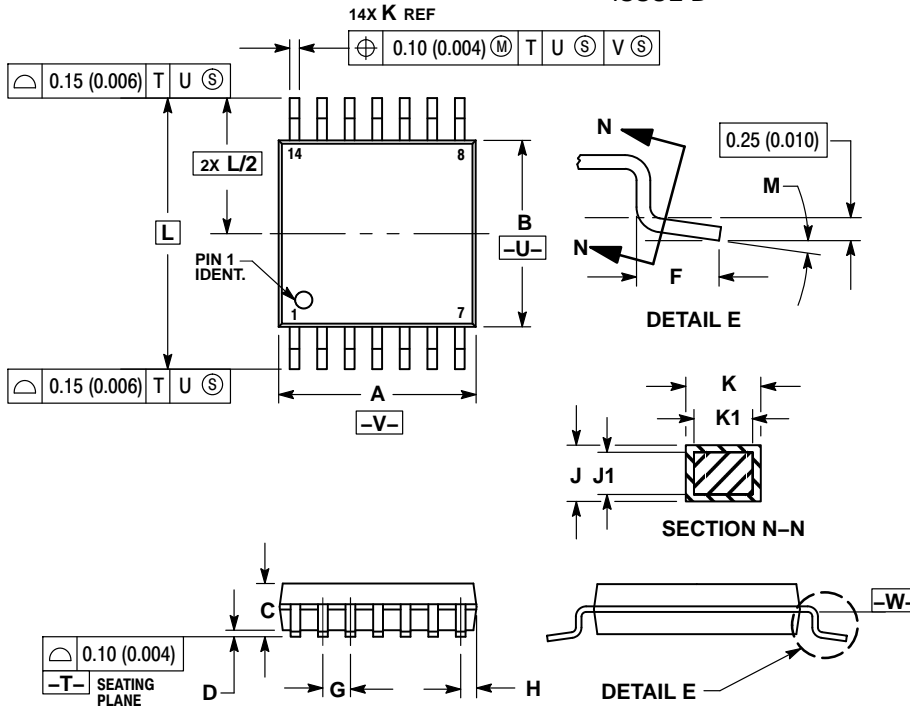

#### NOTES:

1. DIMENSIONING AND TOLERANCING PER ANSI Y14.5M, 1982.
2. CONTROLLING DIMENSION: MILLIMETER.
3. DIMENSION A DOES NOT INCLUDE MOLD FLASH, PROTRUSIONS OR GATE BURRS. MOLD FLASH OR GATE BURRS SHALL NOT EXCEED 0.15 (0.006) PER SIDE.
4. DIMENSION B DOES NOT INCLUDE INTERLEAD FLASH OR PROTRUSION. INTERLEAD FLASH OR PROTRUSION SHALL NOT EXCEED 0.25 (0.010) PER SIDE.
5. DIMENSION K DOES NOT INCLUDE DAMBAR PROTRUSION. ALLOWABLE DAMBAR PROTRUSION SHALL BE 0.08 (0.003) TOTAL IN EXCESS OF THE K DIMENSION AT MAXIMUM MATERIAL CONDITION.
6. TERMINAL NUMBERS ARE SHOWN FOR REFERENCE ONLY.
7. DIMENSION A AND B ARE TO BE DETERMINED AT DATUM PLANE -W-.

DIM	MILLIMETERS		INCHES	
	MIN	MAX	MIN	MAX
A	4.90	5.10	0.193	0.200
B	4.30	4.50	0.169	0.177
C	—	1.20	—	0.047
D	0.05	0.15	0.002	0.006
F	0.50	0.75	0.020	0.030
G	0.65 BSC		0.026 BSC	
H	0.50	0.60	0.020	0.024
J	0.09	0.20	0.004	0.008
J1	0.09	0.16	0.004	0.006
K	0.19	0.30	0.007	0.012
K1	0.19	0.25	0.007	0.010
L	6.40 BSC		0.252 BSC	
M	0°	8°	0°	8°

### SOLDERING FOOTPRINT

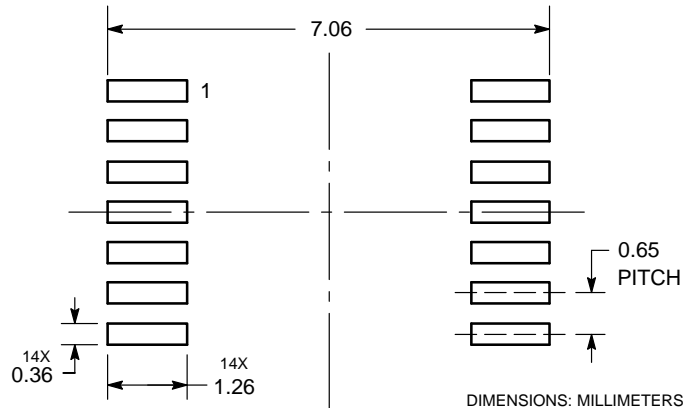

ON Semiconductor and the are registered trademarks of Semiconductor Components Industries, LLC (SCILLC) or its subsidiaries in the United States and/or other countries. SCILLC owns the rights to a number of patents, trademarks, copyrights, trade secrets, and other intellectual property. A listing of SCILLC's product/patent coverage may be accessed at [www.onsemi.com/site/pdf/Patent-Marking.pdf](http://www.onsemi.com/site/pdf/Patent-Marking.pdf). SCILLC reserves the right to make changes without further notice to any products herein. SCILLC makes no warranty, representation or guarantee regarding the suitability of its products for any particular purpose, nor does SCILLC assume any liability arising out of the application or use of any product or circuit, and specifically disclaims any and all liability, including without limitation special, consequential or incidental damages. "Typical" parameters which may be provided in SCILLC data sheets and/or specifications can and do vary in different applications and actual performance may vary over time. All operating parameters, including "Typicals" must be validated for each customer application by customer's technical experts. SCILLC does not convey any license under its patent rights nor the rights of others. SCILLC products are not designed, intended, or authorized for use as components in systems intended for surgical implant into the body, or other applications intended to support or sustain life, or for any other application in which the failure of the SCILLC product could create a situation where personal injury or death may occur. Should Buyer purchase or use SCILLC products for any such unintended or unauthorized application, Buyer shall indemnify and hold SCILLC and its officers, employees, subsidiaries, affiliates, and distributors harmless against all claims, costs, damages, and expenses, and reasonable attorney fees arising out of, directly or indirectly, any claim of personal injury or death associated with such unintended or unauthorized use, even if such claim alleges that SCILLC was negligent regarding the design or manufacture of the part. SCILLC is an Equal Opportunity/Affirmative Action Employer. This literature is subject to all applicable copyright laws and is not for resale in any manner.

### PUBLICATION ORDERING INFORMATION

#### LITERATURE FULFILLMENT:

Literature Distribution Center for ON Semiconductor  
P.O. Box 5163, Denver, Colorado 80217 USA  
Phone: 303-675-2175 or 800-344-3860 Toll Free USA/Canada  
Fax: 303-675-2176 or 800-344-3867 Toll Free USA/Canada  
Email: [orderlit@onsemi.com](mailto:orderlit@onsemi.com)

**N. American Technical Support:** 800-282-9855 Toll Free  
USA/Canada  
**Europe, Middle East and Africa Technical Support:**  
Phone: 421 33 790 2910  
**Japan Customer Focus Center**  
Phone: 81-3-5817-1050

**ON Semiconductor Website:** [www.onsemi.com](http://www.onsemi.com)

**Order Literature:** <http://www.onsemi.com/orderlit>

For additional information, please contact your local Sales Representative

# AMEYA360

## Components Supply Platform

Authorized Distribution Brand :



Website :

Welcome to visit [www.ameya360.com](http://www.ameya360.com)

Contact Us :

➤ Address :

401 Building No.5, JiuGe Business Center, Lane 2301, Yishan Rd  
Minhang District, Shanghai , China

➤ Sales :

Direct +86 (21) 6401-6692

Email [amall@ameya360.com](mailto:amall@ameya360.com)

QQ 800077892

Skype [ameyasales1](#) [ameyasales2](#)

➤ Customer Service :

Email [service@ameya360.com](mailto:service@ameya360.com)

➤ Partnership :

Tel +86 (21) 64016692-8333

Email [mkt@ameya360.com](mailto:mkt@ameya360.com)