

Features

- One-input to nine-output buffer/driver
- Supports two DIMMs or four SO-DIMMs with one additional output for feedback to an external or chipset phase-locked loop (PLL)
- Low power consumption for mobile applications
 - Less than 32 mA at 66.6 MHz with unloaded outputs
- 1-ns Input-output delay
- Buffers all frequencies from DC to 133.33 MHz
- Output-output skew less than 250 ps
- Multiple V_{DD} and V_{SS} pins for noise and electromagnetic interference (EMI) reduction
- Space-saving 16-pin 150-mil small-outline integrated circuit (SOIC) package
- 3.3 V operation
- Industrial temperature available

Functional Description

The CY2309NZ is a low-cost buffer designed to distribute high-speed clocks in mobile PC systems and desktop PC systems with SDRAM support. The part has nine outputs, eight of which can be used to drive two DIMMs or four SO-DIMMs, and the remaining can be used for external feedback to a PLL. The device operates at 3.3V and outputs can run up to 133.33 MHz.

The CY2309NZ is designed for low EMI and power optimization. It has multiple V_{SS} and V_{DD} pins for noise optimization and consumes less than 32 mA at 66.6 MHz, making it ideal for the low-power requirements of mobile systems. It is available in an ultra-compact 150-mil 16-pin SOIC package.

For a complete list of related documentation, click [here](#).

Logic Block Diagram

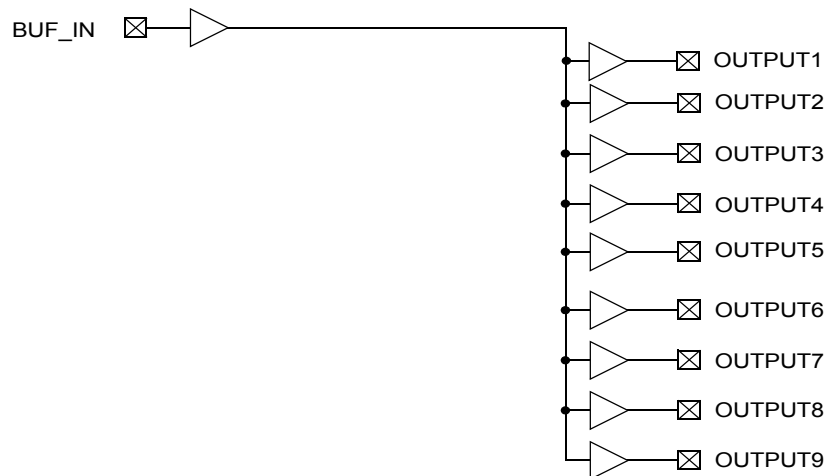

Contents

Pinouts	3	Acronyms	9
Pin Descriptions	3	Document Conventions	9
Maximum Ratings	4	Units of Measure	9
Operating Conditions	4	Document History Page	10
Electrical Characteristics	4	Sales, Solutions, and Legal Information	11
Switching Characteristics	5	Worldwide Sales and Design Support	11
Switching Waveforms	6	Products	11
Test Circuits	6	PSoC® Solutions	11
Ordering Information	7	Cypress Developer Community	11
Ordering Code Definitions	7	Technical Support	11
Package Diagram	8		

Pinouts

Figure 1. 16-pin SOIC pinout (Top View)

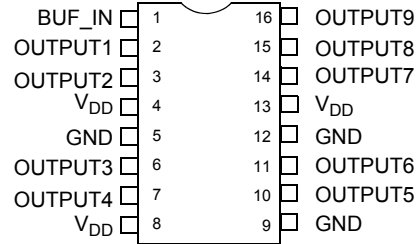

Pin Descriptions

Pin	Signal	Description
4, 8, 13	V _{DD}	3.3 V Digital voltage supply
5, 9, 12	GND	Ground
1	BUF_IN	Input clock
2, 3, 6, 7, 10, 11, 14, 15, 16	OUTPUT [1:9]	Outputs

Maximum Ratings

Supply voltage to ground potential	-0.5 V to +7.0 V	Storage temperature	-65 °C to +150 °C
DC input voltage	-0.5 V to 7.0 V	Junction temperature	150 °C
		Static discharge voltage (per MIL-STD-883, Method 3015)	>2,000 V

Operating Conditions

For Commercial and Industrial Temperature Devices

Parameter	Description	Min	Max	Unit
V _{DD}	Supply voltage	3.0	3.6	V
T _A	(Ambient operating temperature) commercial	0	70	°C
	(Ambient operating temperature) industrial	-40	85	°C
C _L	Load capacitance, F _{out} < 100 MHz	-	30	pF
	Load capacitance, 100 MHz < F _{out} < 133.33 MHz	-	15	pF
C _{IN}	Input capacitance	-	7	pF
BUF_IN, OUTPUT [1:9]	Operating frequency	DC	133.33	MHz
t _{PU}	Power-up time for all VDDs to reach minimum specified voltage (power ramps must be monotonic)	0.05	50	ms

Electrical Characteristics

For Commercial and Industrial Temperature Devices

Parameter	Description	Test Conditions	Min	Max	Unit
V _{IL}	Input LOW voltage ^[1]		-	0.8	V
V _{IH}	Input HIGH voltage ^[1]		2.0	-	V
I _{IL}	Input LOW current	V _{IN} = 0 V	-	50.0	μA
I _{IH}	Input HIGH current	V _{IN} = V _{DD}	-	100.0	μA
V _{OL}	Output LOW voltage ^[2]	I _{OL} = 8 mA	-	0.4	V
V _{OH}	Output HIGH voltage ^[2]	I _{OH} = -8 mA	2.4	-	V
I _{DD}	Supply current	Unloaded outputs at 66.66 MHz	-	32	mA

Notes

1. BUF_IN input has a threshold voltage of V_{DD}/2.
2. Parameter is guaranteed by design and characterization. It is not 100% tested in production.

Switching Characteristics

For Commercial and Industrial Temperature Devices ^[3]

Parameter	Description	Condition	Min	Typ	Max	Unit
	Duty cycle ^[4] = $t_2 \div t_1$	Measured at 1.4 V	40.0	50.0	60.0	%
t ₃	Rise time ^[4]	Measured between 0.8 V and 2.0 V	–	–	1.50	ns
t ₄	Fall time ^[4]	Measured between 0.8 V and 2.0 V	–	–	1.50	ns
t ₅	Output to output skew ^[4]	All outputs equally loaded	–	–	250	ps
t ₆	Propagation delay, BUF_IN Rising edge to Output Rising edge ^[4]	Measured at V _{DD} /2	1	5	9.2	ns

Notes

3. All parameters specified with loaded outputs.
4. Parameter is guaranteed by design and characterization. It is not 100% tested in production.

Switching Waveforms

Figure 2. Duty Cycle Timing

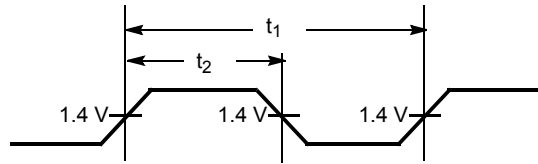

Figure 3. All Outputs Rise/Fall Time

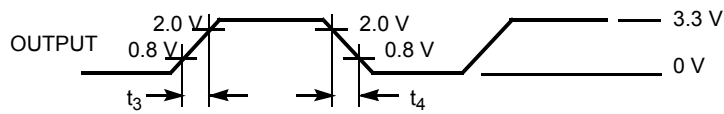

Figure 4. Output-Output Skew

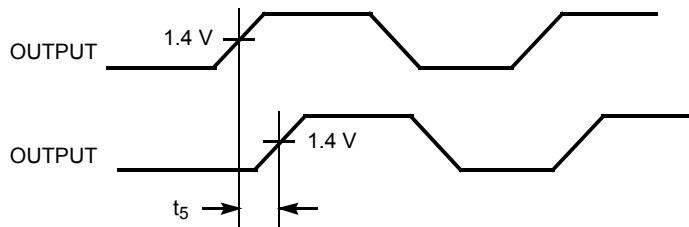
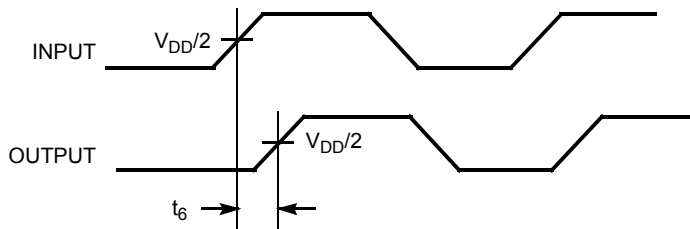
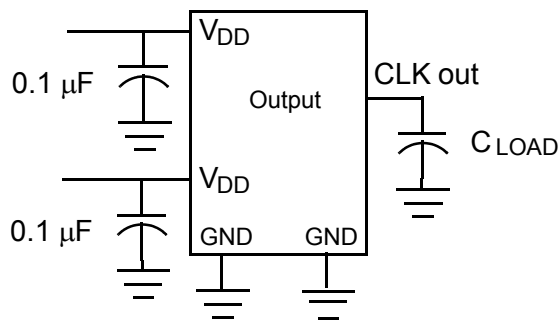

Figure 5. Input-Output Propagation Delay



Test Circuits

Figure 6. Test Circuits



Acronyms

Acronym	Description
EMI	Electromagnetic Interference
PLL	Phase-Locked Loop
SOIC	Small-Outline Integrated Circuit

Document Conventions

Units of Measure

Symbol	Unit of Measure
°C	degrees Celsius
MHz	megahertz
μA	microampere
mA	milliampere
ms	millisecond
mV	millivolt
ns	nanosecond
pF	picofarad
V	volt

Document History Page

Document Title: CY2309NZ, Nine-Output 3.3 V Buffer Document Number: 38-07182				
Rev.	ECN	Orig. of Change	Submission Date	Description of Change
**	111858	DSG	12/09/01	Change from Spec number: 38-00709 to 38-07182
*A	121834	RBI	12/14/02	Power-up requirements added to Operating Conditions Information
*B	130563	SDR	10/23/03	Added industrial operating temperature to operating conditions
*C	212991	RGL / GK	03/30/04	Updated the propagation delay T ₆ spec to 9.2 ns in the Switching Characteristics table
*D	270149	RGL	10/04/04	Added Lead-free devices Replaced 8.7 ns Input/Output Delay to 1 ns Input/Output Delaying the features section
*E	2568533	AESA	09/23/08	Changed "SDRAM [1:9]" to "OUTPUT [1:9]" in Operating Conditions table. Removed part number CY2309NZSI-1H and CY2309NZSI-1HT. Added Note "Not recommended for new designs." Updated template.
*F	2904715	CXQ	04/05/10	Removed parts CY2309NZSC-1H,CY2309NZSC-1HT from Ordering Information. Updated Package Diagram
*G	3082147	CXQ	11/10/2010	Maximum Rating section on page 2, change the following from: "DC Input Voltage (Except REF) -0.5 V to VDD + 0.5 V" "DC Input Voltage REF-0.5 V to 7.0 V" to: "DC Input Voltage-0.5 V to 7.0 V" Updated footnotes Added Ordering Code Definitions . Added Acronyms and Units of Measure . Updated data sheet as per new template.
*H	4201460	CINM	11/25/2013	Updated Package Diagram : spec 51-85068 – Changed revision from *C to *E. Updated in new template. Completing Sunset Review.
*I	4578443	TAVA	11/25/2014	Added related documentation hyperlink in page 1.

Sales, Solutions, and Legal Information

Worldwide Sales and Design Support

Cypress maintains a worldwide network of offices, solution centers, manufacturer's representatives, and distributors. To find the office closest to you, visit us at [Cypress Locations](#).

Products

Automotive	cypress.com/go/automotive
Clocks & Buffers	cypress.com/go/clocks
Interface	cypress.com/go/interface
Lighting & Power Control	cypress.com/go/powerpsoc cypress.com/go/plc
Memory	cypress.com/go/memory
PSoC	cypress.com/go/psoc
Touch Sensing	cypress.com/go/touch
USB Controllers	cypress.com/go/USB
Wireless/RF	cypress.com/go/wireless

PSoC[®] Solutions

[psoc.cypress.com/solutions](#)
[PSoC 1](#) | [PSoC 3](#) | [PSoC 4](#) | [PSoC 5LP](#)

Cypress Developer Community

[Community](#) | [Forums](#) | [Blogs](#) | [Video](#) | [Training](#)

Technical Support

[cypress.com/go/support](#)

© Cypress Semiconductor Corporation, 2001-2014. The information contained herein is subject to change without notice. Cypress Semiconductor Corporation assumes no responsibility for the use of any circuitry other than circuitry embodied in a Cypress product. Nor does it convey or imply any license under patent or other rights. Cypress products are not warranted nor intended to be used for medical, life support, life saving, critical control or safety applications, unless pursuant to an express written agreement with Cypress. Furthermore, Cypress does not authorize its products for use as critical components in life-support systems where a malfunction or failure may reasonably be expected to result in significant injury to the user. The inclusion of Cypress products in life-support systems application implies that the manufacturer assumes all risk of such use and in doing so indemnifies Cypress against all charges.

Any Source Code (software and/or firmware) is owned by Cypress Semiconductor Corporation (Cypress) and is protected by and subject to worldwide patent protection (United States and foreign), United States copyright laws and international treaty provisions. Cypress hereby grants to licensee a personal, non-exclusive, non-transferable license to copy, use, modify, create derivative works of, and compile the Cypress Source Code and derivative works for the sole purpose of creating custom software and or firmware in support of licensee product to be used only in conjunction with a Cypress integrated circuit as specified in the applicable agreement. Any reproduction, modification, translation, compilation, or representation of this Source Code except as specified above is prohibited without the express written permission of Cypress.

Disclaimer: CYPRESS MAKES NO WARRANTY OF ANY KIND, EXPRESS OR IMPLIED, WITH REGARD TO THIS MATERIAL, INCLUDING, BUT NOT LIMITED TO, THE IMPLIED WARRANTIES OF MERCHANTABILITY AND FITNESS FOR A PARTICULAR PURPOSE. Cypress reserves the right to make changes without further notice to the materials described herein. Cypress does not assume any liability arising out of the application or use of any product or circuit described herein. Cypress does not authorize its products for use as critical components in life-support systems where a malfunction or failure may reasonably be expected to result in significant injury to the user. The inclusion of Cypress' product in a life-support systems application implies that the manufacturer assumes all risk of such use and in doing so indemnifies Cypress against all charges.

Use may be limited by and subject to the applicable Cypress software license agreement.

AMEYA360

Components Supply Platform

Authorized Distribution Brand :



Website :

Welcome to visit www.ameya360.com

Contact Us :

➤ Address :

401 Building No.5, JiuGe Business Center, Lane 2301, Yishan Rd
Minhang District, Shanghai , China

➤ Sales :

Direct +86 (21) 6401-6692

Email amall@ameya360.com

QQ 800077892

Skype [ameyasales1](#) [ameyasales2](#)

➤ Customer Service :

Email service@ameya360.com

➤ Partnership :

Tel +86 (21) 64016692-8333

Email mkt@ameya360.com