

DRA73, DRA74, DRA124, DRA125 & DRA127 Series High Power Density, High Efficiency Shielded Inductors for Automotive Applications

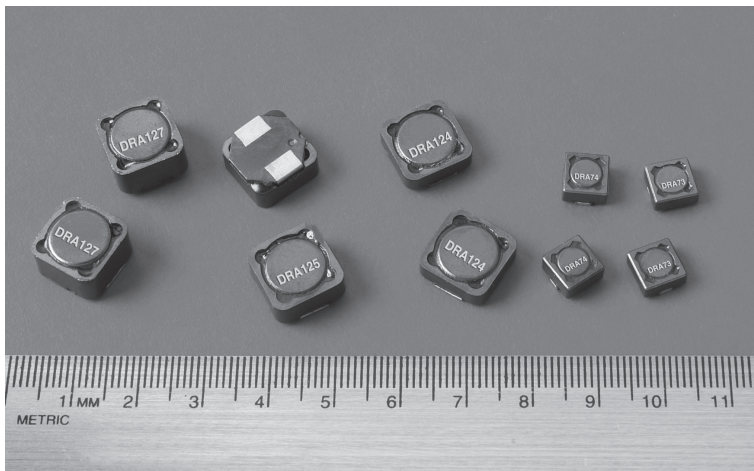

Applications

- Automotive electronics (under hood, interior/ exterior)
- Telematics
- GPS
- LED Lighting
- LCD Display
- Portable media devices

Environmental data

- Storage temperature range (component): -40°C to +165°C
- Operating temperature range: -40°C to +165°C (ambient + self-temperature rise)
- Solder reflow temperature: J-STD-020D compliant
- Complies with AEC-Q200 standard

Packaging

- Supplied in tape-and-reel packaging on a 13 inch diameter reel

Description

- Halogen free, lead free, RoHS compliant
- 165°C Maximum total temperature operation
- Five different mechanical sizes available
- Magnetically shielded-reduces EMI
- Ferrite core material
- Inductance range from 0.28 μ H to 1000 μ H
- Current range up to 56 amps
- Rugged construction for high shock and vibration environments



Powering Business Worldwide



The Coiltronics brand of magnetics (formerly of the Bussmann Division of Cooper Industries) is now part of Eaton's Electrical Group, Electronics Division.

Coiltronics is now part of Eaton
Same great products plus even more.

Product specifications

DRA73 Series - 7.6 x 7.6 x 3.55mm

Part Number ⁶	OCL ¹ ±20% (µH)	I _{rms} ² (Amps)	I _{sat} 1 ³ (Amps)	I _{sat} 2 ⁴ (Amps)	DCR (Ω) @ 25°C Typical	DCR (Ω) @ 25°C Maximum	K-Factor ⁵
DRA73-R33-R	0.29	8.42	14.8	11.8	0.0040	0.0048	636.5
DRA73-1R0-R	0.91	6.50	8.22	6.58	0.0067	0.0080	353.6
DRA73-1R5-R	1.36	5.39	6.73	5.38	0.0097	0.0117	289.3
DRA73-2R2-R	2.52	4.18	4.93	3.95	0.016	0.019	212.2
DRA73-3R3-R	3.18	3.59	4.35	3.48	0.022	0.026	187.2
DRA73-4R7-R	4.86	2.92	3.52	2.82	0.033	0.040	151.6
DRA73-6R8-R	6.63	2.62	2.96	2.37	0.041	0.049	127.3
DRA73-8R2-R	8.06	2.30	2.74	2.19	0.053	0.064	117.9
DRA73-100-R	10.27	2.11	2.39	1.91	0.064	0.077	102.7
DRA73-150-R	14.98	1.74	2.00	1.60	0.094	0.112	86.0
DRA73-220-R	22.39	1.42	1.64	1.32	0.141	0.170	70.7
DRA73-330-R	31.84	1.25	1.35	1.08	0.183	0.219	57.9
DRA73-470-R	47.83	1.02	1.10	0.884	0.275	0.330	47.5
DRA73-680-R	66.89	0.845	0.937	0.749	0.397	0.476	40.3
DRA73-820-R	83.77	0.731	0.851	0.680	0.530	0.636	36.6
DRA73-101-R	101.7	0.682	0.763	0.610	0.609	0.731	32.8
DRA73-151-R	151.1	0.551	0.632	0.506	0.932	1.12	27.2
DRA73-221-R	218.8	0.479	0.510	0.408	1.23	1.48	21.9
DRA73-331-R	326.4	0.391	0.423	0.338	1.85	2.22	18.2
DRA73-471-R	472.6	0.326	0.354	0.283	2.67	3.20	15.2
DRA73-681-R	682.9	0.270	0.297	0.238	3.89	4.66	12.8
DRA73-821-R	825.3	0.252	0.267	0.214	4.46	5.35	11.5
DRA73-102-R	991.9	0.235	0.239	0.192	5.15	6.18	10.3

1. Open Circuit Inductance (OCL) Test Parameters: 100kHz, 0.25V_{rms}, 0.0Adc @ 25°C
2. I_{rms}: DC current for an approximate temperature rise of 40°C without core loss. Derating is necessary for AC currents. PCB layout, trace thickness and width, air-flow and proximity of other heat generating components will affect the temperature rise. It is recommended that the temperature of the part not exceed 165°C under worst case operating conditions verified in the end application.
3. I_{sat}1: Peak current for approximately 30% rolloff at +25°C.

4. I_{sat}2: Peak current for approximately 40% rolloff at +125°C.
5. K-factor: Used to determine Bp-p for core loss (see graph). $B_{p-p} = K * L * \Delta I$. B_{p-p}:(Gauss), K: (K-factor from table), L: (Inductance in µH), ΔI (peak-to-peak ripple current in amps).
6. Part Number Definition: DRAxxx-yyy-R
 - DRAxxx = Product code and size
 - yyy= Inductance value in uH, R = decimal point, if no R is present then third character = number of zeros.
 - -R suffix = RoHS compliant1

DRA73, DRA74, DRA124, DRA125 and DRA127 Series

Product specifications

DRA74 Series - 7.6 x 7.6 x 4.35mm

Part Number ⁶	OCL ¹ ±20% (µH)	I _{rms} ² (Amps)	I _{sat} 1 ³ (Amps)	I _{sat} 2 ⁴ (Amps)	DCR (Ω) @ 25°C Typical	DCR (Ω) @ 25°C Maximum	K-Factor ⁵
DRA74-R33-R	0.29	7.26	18.4	14.7	0.0054	0.0064	547.9
DRA74-1R0-R	0.90	6.01	10.2	8.18	0.0078	0.0094	304.4
DRA74-1R5-R	1.31	5.55	8.36	6.69	0.0092	0.0110	249.0
DRA74-2R2-R	2.33	4.82	6.13	4.91	0.012	0.015	182.6
DRA74-3R3-R	3.05	4.16	5.41	4.33	0.016	0.020	161.1
DRA74-4R7-R	4.68	3.41	4.38	3.50	0.024	0.029	130.4
DRA74-6R8-R	6.51	2.91	3.68	2.94	0.034	0.040	109.6
DRA74-8R2-R	8.51	2.66	3.17	2.54	0.040	0.048	94.5
DRA74-100-R	9.62	2.56	2.97	2.37	0.043	0.052	88.4
DRA74-150-R	15.14	2.06	2.36	1.89	0.067	0.080	70.2
DRA74-220-R	22.25	1.68	1.96	1.57	0.100	0.120	58.3
DRA74-330-R	33.21	1.37	1.61	1.29	0.151	0.181	48.1
DRA74-470-R	46.56	1.14	1.37	1.10	0.219	0.263	40.9
DRA74-680-R	68.37	0.996	1.11	0.887	0.286	0.343	33.0
DRA74-820-R	81.45	0.879	1.03	0.827	0.367	0.440	30.8
DRA74-101-R	98.50	0.822	0.929	0.743	0.419	0.503	27.7
DRA74-151-R	150.9	0.661	0.748	0.598	0.648	0.780	22.3
DRA74-221-R	218.9	0.544	0.626	0.501	0.960	1.15	18.6
DRA74-331-R	328.9	0.435	0.514	0.411	1.50	1.79	15.3
DRA74-471-R	471.5	0.383	0.420	0.336	1.93	2.31	12.5
DRA74-681-R	682.8	0.315	0.352	0.282	2.86	3.43	10.5
DRA74-821-R	815.0	0.279	0.327	0.262	3.63	4.35	9.7
DRA74-102-R	1001.7	0.260	0.292	0.234	4.19	5.02	8.7

1. Open Circuit Inductance (OCL) Test Parameters: 100kHz, 0.25V_{rms}, 0.0Adc @ 25°C
2. I_{rms}: DC current for an approximate temperature rise of 40°C without core loss. Derating is necessary for AC currents. PCB layout, trace thickness and width, air-flow and proximity of other heat generating components will affect the temperature rise. It is recommended that the temperature of the part not exceed 165°C under worst case operating conditions verified in the end application.
3. I_{sat}1: Peak current for approximately 30% rolloff at +25°C.

4. I_{sat}2: Peak current for approximately 40% rolloff at +125°C.
5. K-factor: Used to determine Bp-p for core loss (see graph). $B_{p-p} = K * L * \Delta I$. B_{p-p}:(Gauss), K: (K-factor from table), L: (Inductance in µH), ΔI (peak-to-peak ripple current in amps).
6. Part Number Definition: DRAxxx-yyy-R
 - DRAxxx = Product code and size
 - yyy= Inductance value in uH, R = decimal point, if no R is present then third character = number of zeros.
 - -R suffix = RoHS compliant1

Product specifications

DRA124 Series - 12.5 x 12.5 x 4.5mm

Part Number ⁶	OCL ¹ ±20% (µH)	I _{rms} ² (Amps)	I _{sat} 1 ³ (Amps)	I _{sat} 2 ⁴ (Amps)	DCR (Ω) @ 25°C Typical	DCR (Ω) @ 25°C Maximum	K-Factor ⁵
DRA124-R47-R	0.42	13.5	30.8	24.6	0.0024	0.0028	196.9
DRA124-1R0-R	0.82	11.7	22.0	17.6	0.0031	0.0038	140.7
DRA124-1R5-R	1.36	9.36	17.1	13.7	0.0049	0.0058	109.4
DRA124-2R2-R	2.04	7.64	14.0	11.2	0.0070	0.0090	89.5
DRA124-3R3-R	2.79	6.94	11.9	9.48	0.0090	0.011	75.7
DRA124-4R7-R	4.74	5.47	9.06	7.25	0.014	0.017	57.9
DRA124-6R8-R	7.28	4.46	7.33	5.87	0.021	0.026	46.9
DRA124-8R2-R	8.88	3.87	6.70	5.36	0.028	0.034	42.8
DRA124-100-R	10.37	3.67	6.16	4.93	0.031	0.038	39.4
DRA124-150-R	14.10	3.10	5.31	4.25	0.044	0.053	34.0
DRA124-220-R	23.00	2.44	4.16	3.33	0.071	0.086	26.6
DRA124-330-R	34.13	1.98	3.42	2.74	0.108	0.130	21.9
DRA124-470-R	46.27	1.78	2.91	2.33	0.134	0.160	18.6
DRA124-680-R	69.77	1.45	2.37	1.90	0.201	0.241	15.1
DRA124-820-R	80.57	1.29	2.23	1.79	0.257	0.309	14.3
DRA124-101-R	98.80	1.20	2.00	1.60	0.296	0.355	12.8
DRA124-151-R	151.7	0.967	1.62	1.30	0.454	0.550	10.4
DRA124-221-R	209.6	0.865	1.36	1.09	0.568	0.680	8.7
DRA124-331-R	326.9	0.690	1.09	0.874	0.892	1.070	7.0
DRA124-471-R	473.0	0.568	0.911	0.729	1.32	1.58	5.8
DRA124-681-R	682.1	0.466	0.759	0.607	1.96	2.35	4.9
DRA124-821-R	826.7	0.406	0.697	0.557	2.57	3.09	4.5
DRA124-102-R	1001.0	0.380	0.629	0.503	2.94	3.52	4.0

1. Open Circuit Inductance (OCL) Test Parameters: 100kHz, 0.25V_{rms}, 0.0Adc @ 25°C
2. I_{rms}: DC current for an approximate temperature rise of 40°C without core loss. Derating is necessary for AC currents. PCB layout, trace thickness and width, air-flow and proximity of other heat generating components will affect the temperature rise. It is recommended that the temperature of the part not exceed 165°C under worst case operating conditions verified in the end application.
3. I_{sat} 1: Peak current for approximately 30% rolloff at +25°C.

4. I_{sat} 2: Peak current for approximately 40% rolloff at +125°C.
5. K-factor: Used to determine B_{p-p} for core loss (see graph). $B_{p-p} = K * L * \Delta I$. B_{p-p}:(Gauss), K: (K-factor from table), L: (Inductance in µH), ΔI (peak-to-peak ripple current in amps).
6. Part Number Definition: DRAXxx-yyy-R
 - DRAXxx = Product code and size
 - yyy= Inductance value in µH, R = decimal point, if no R is present then third character = number of zeros.
 - -R suffix = RoHS compliant1

Product specifications

DRA125 Series - 12.5 x 12.5 x 6.0mm

Part Number ⁶	OCL ¹ ±20% (µH)	I _{rms} ² (Amps)	I _{sat} 1 ³ (Amps)	I _{sat} 2 ⁴ (Amps)	DCR (Ω) @ 25°C Typical	DCR (Ω) @ 25°C Maximum	K-Factor ⁵
DRA125-R47-R	0.45	14.7	33.2	26.6	0.0025	0.0030	176.9
DRA125-1R0-R	0.85	12.7	23.7	19.0	0.0034	0.0042	126.4
DRA125-1R5-R	1.41	12.9	18.4	14.8	0.0033	0.0039	98.3
DRA125-2R2-R	2.12	10.6	15.1	12.1	0.0048	0.0058	80.4
DRA125-3R3-R	2.89	8.63	12.8	10.2	0.0073	0.0087	68.0
DRA125-4R7-R	4.90	7.67	9.76	7.81	0.0092	0.011	52.0
DRA125-6R8-R	6.23	6.81	8.74	6.99	0.012	0.014	46.6
DRA125-8R2-R	7.49	6.41	7.90	6.32	0.013	0.016	42.1
DRA125-100-R	9.22	5.57	7.22	5.77	0.017	0.021	38.5
DRA125-150-R	14.67	4.45	5.72	4.58	0.027	0.033	30.5
DRA125-220-R	20.65	3.95	4.74	3.79	0.035	0.042	25.3
DRA125-330-R	31.47	3.19	3.86	3.09	0.053	0.064	20.6
DRA125-470-R	47.83	2.59	3.13	2.51	0.081	0.097	16.7
DRA125-680-R	68.48	2.13	2.64	2.11	0.120	0.144	14.0
DRA125-820-R	80.86	2.01	2.41	1.93	0.135	0.162	12.8
DRA125-101-R	97.60	1.75	2.21	1.77	0.178	0.214	11.8
DRA125-151-R	150.0	1.41	1.79	1.43	0.273	0.330	9.5
DRA125-221-R	222.8	1.14	1.47	1.18	0.416	0.500	7.8
DRA125-331-R	325.1	1.00	1.19	0.96	0.543	0.650	6.4
DRA125-471-R	466.3	0.826	1.01	0.805	0.790	0.950	5.4
DRA125-681-R	683.3	0.673	0.834	0.667	1.200	1.440	4.4
DRA125-821-R	813.6	0.632	0.758	0.606	1.360	1.630	4.0
DRA125-102-R	992.8	0.552	0.695	0.556	1.780	2.130	3.7

1. Open Circuit Inductance (OCL) Test Parameters: 100kHz, 0.25V_{rms}, 0.0A_{dc} @ 25°C
2. I_{rms}: DC current for an approximate temperature rise of 40°C without core loss. Derating is necessary for AC currents. PCB layout, trace thickness and width, air-flow and proximity of other heat generating components will affect the temperature rise. It is recommended that the temperature of the part not exceed 165°C under worst case operating conditions verified in the end application.
3. I_{sat}1: Peak current for approximately 30% rolloff at +25°C.

4. I_{sat}2: Peak current for approximately 40% rolloff at +125°C.
5. K-factor: Used to determine B_{p-p} for core loss (see graph). $B_{p-p} = K * L * \Delta I$. B_{p-p}:(Gauss), K: (K-factor from table), L: (Inductance in µH), ΔI (peak-to-peak ripple current in amps).
6. Part Number Definition: DRAXxx-yyy-R
 - DRAXxx = Product code and size
 - yyy= Inductance value in µH, R = decimal point, if no R is present then third character = number of zeros.
 - -R suffix = RoHS compliant1

Product specifications

DRA127 Series - 12.5 x 12.5 x 8.0mm

Part Number ⁶	OCL ¹ ±20% (µH)	I _{rms} ² (Amps)	I _{sat} 1 ³ (Amps)	I _{sat} 2 ⁴ (Amps)	DCR (Ω) @ 25°C Typical	DCR (Ω) @ 25°C Maximum	K-Factor ⁵
DRA127-R47-R	0.41	15.9	56.0	44.8	0.0024	0.0030	120.0
DRA127-1R0-R	0.77	13.6	40.0	32.0	0.0034	0.0040	85.7
DRA127-1R5-R	1.27	12.2	31.1	24.9	0.0043	0.0051	66.7
DRA127-2R2-R	1.92	12.5	25.5	20.4	0.0040	0.0048	54.6
DRA127-3R3-R	3.51	8.54	18.7	14.9	0.0086	0.0104	40.0
DRA127-4R7-R	4.58	8.14	16.5	13.2	0.0094	0.011	35.3
DRA127-6R8-R	6.72	6.52	13.3	10.7	0.015	0.018	28.6
DRA127-8R2-R	8.33	6.33	12.2	9.74	0.016	0.019	26.1
DRA127-100-R	9.63	6.02	11.2	8.96	0.017	0.021	24.0
DRA127-150-R	14.90	4.83	9.03	7.23	0.027	0.032	19.4
DRA127-220-R	21.47	3.98	7.57	6.05	0.040	0.047	16.2
DRA127-330-R	32.01	3.22	6.22	4.98	0.060	0.072	13.3
DRA127-470-R	47.91	2.62	5.09	4.07	0.091	0.110	10.9
DRA127-680-R	68.22	2.33	4.18	3.34	0.115	0.138	9.0
DRA127-820-R	83.91	2.01	3.84	3.07	0.155	0.186	8.2
DRA127-101-R	100.8	1.89	3.46	2.77	0.175	0.210	7.4
DRA127-151-R	151.2	1.52	2.83	2.26	0.269	0.320	6.1
DRA127-221-R	219.8	1.25	2.35	1.88	0.398	0.480	5.0
DRA127-331-R	328.3	1.01	1.93	1.54	0.612	0.730	4.1
DRA127-471-R	474.5	0.827	1.62	1.29	0.910	1.10	3.5
DRA127-681-R	676.6	0.736	1.33	1.06	1.15	1.39	2.8
DRA127-821-R	824.6	0.637	1.22	0.978	1.54	1.85	2.6
DRA127-102-R	998.7	0.598	1.10	0.878	1.75	2.10	2.4

1. Open Circuit Inductance (OCL) Test Parameters: 100kHz, 0.25V_{rms}, 0.0Adc @ 25°C
2. I_{rms}²: DC current for an approximate temperature rise of 40°C without core loss. Derating is necessary for AC currents. PCB layout, trace thickness and width, air-flow and proximity of other heat generating components will affect the temperature rise. It is recommended that the temperature of the part not exceed 165°C under worst case operating conditions verified in the end application.
3. I_{sat} 1³: Peak current for approximately 30% rolloff at +25°C.

4. I_{sat} 2⁴: Peak current for approximately 40% rolloff at +125°C.
5. K-factor: Used to determine Bp-p for core loss (see graph). $B_{p-p} = K * L * \Delta I$. B_{p-p}:(Gauss), K: (K-factor from table), L: (Inductance in µH), ΔI (peak-to-peak ripple current in amps).
6. Part Number Definition: DRAxxyy-R
 - DRAxxyy = Product code and size
 - yyy= Inductance value in µH, R = decimal point, if no R is present then third character = number of zeros.
 - -R suffix = RoHS compliant1

Temperature rise vs. total loss

DRA73

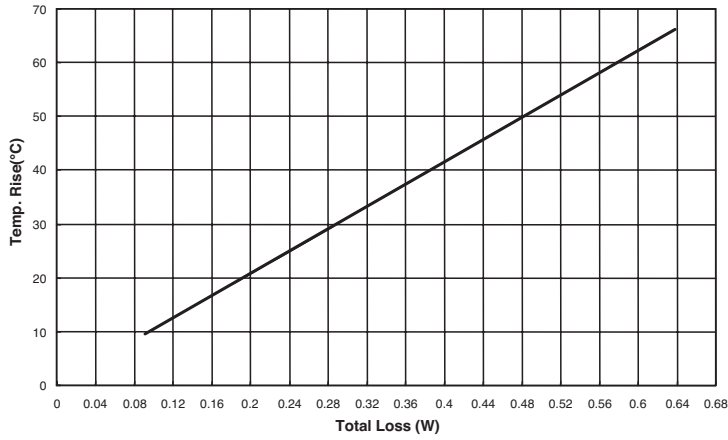

DRA74

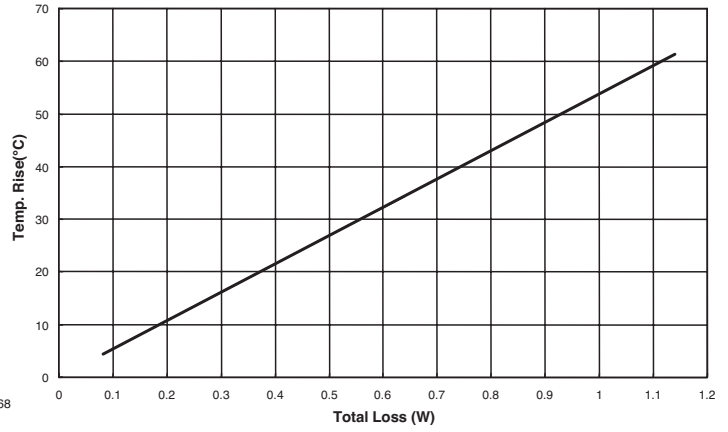

DRA124

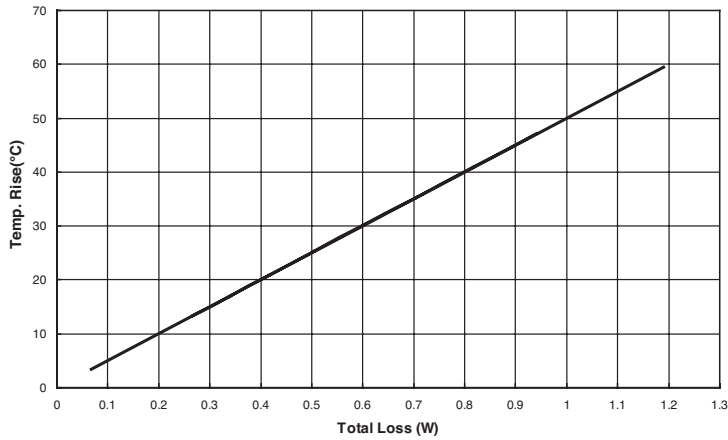

DRA125

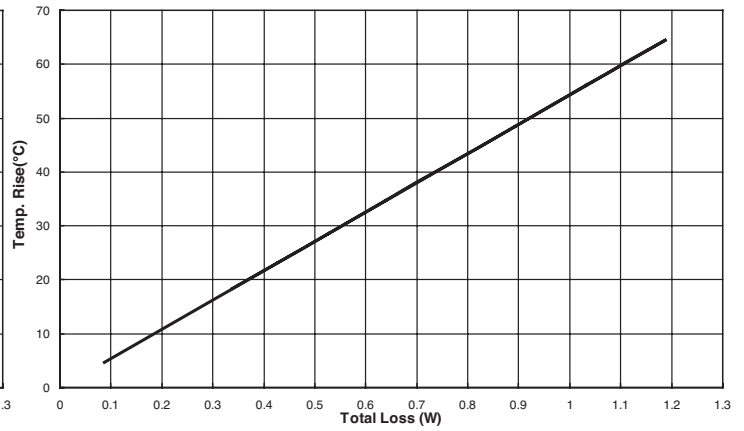

DRA127

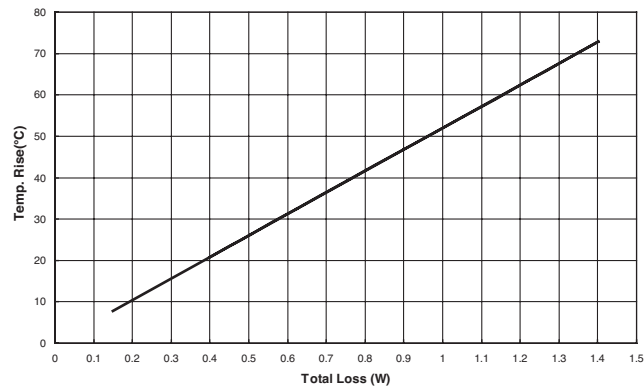

Core loss

DRA73

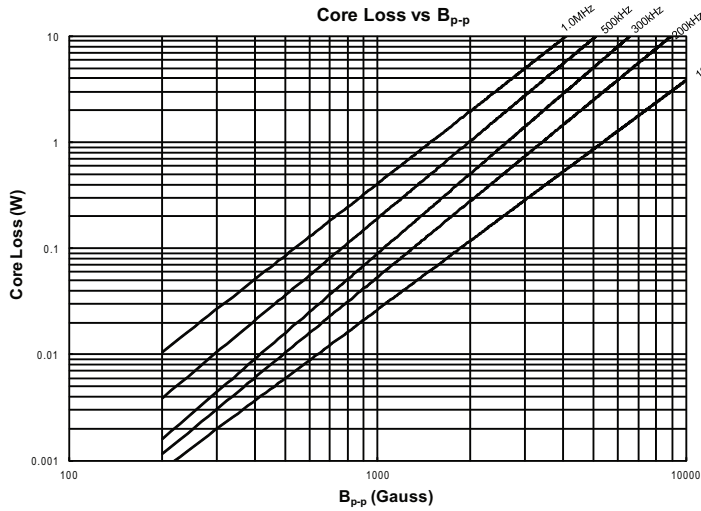

DRA74

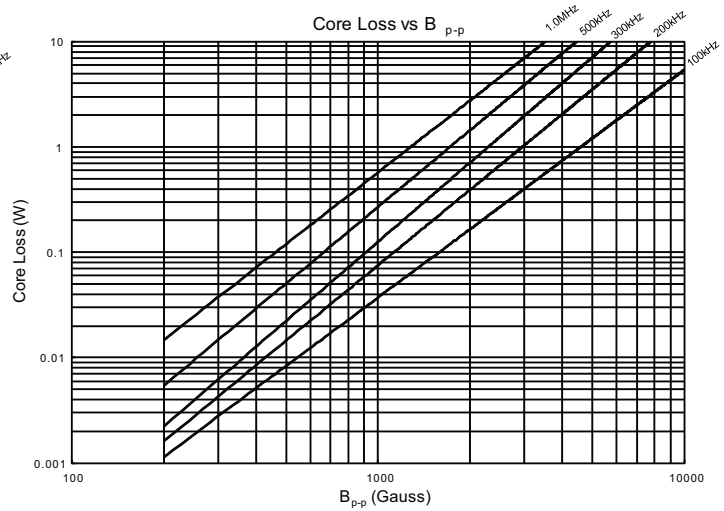

DRA124

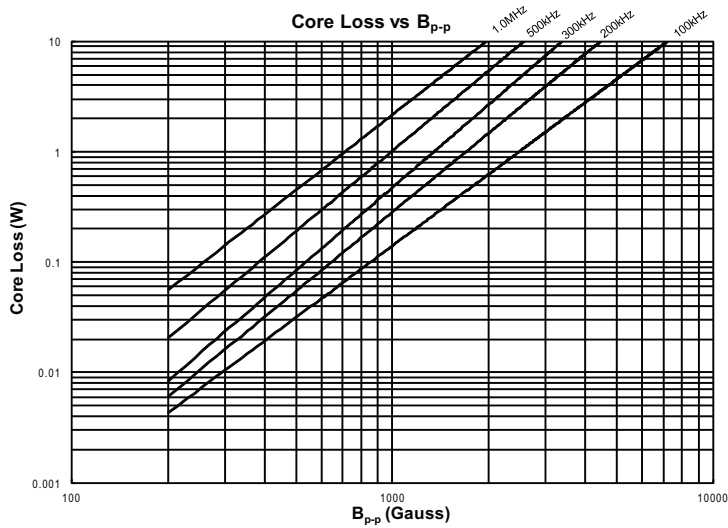

DRA125

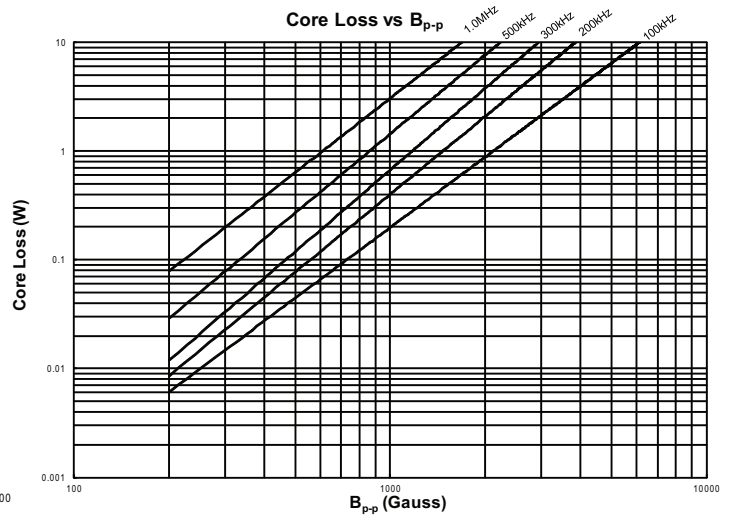

DRA127

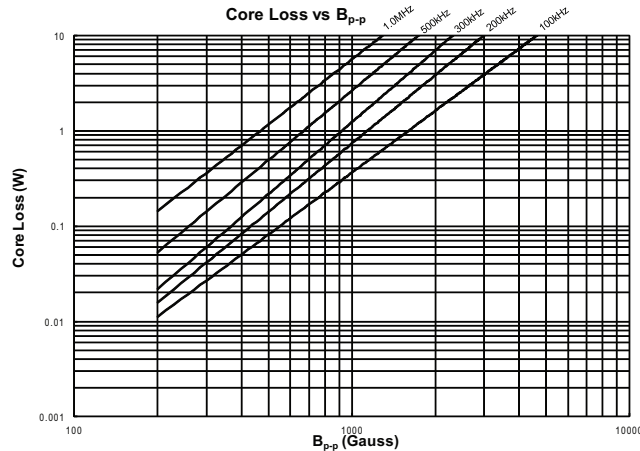

Inductance characteristics

DRA73

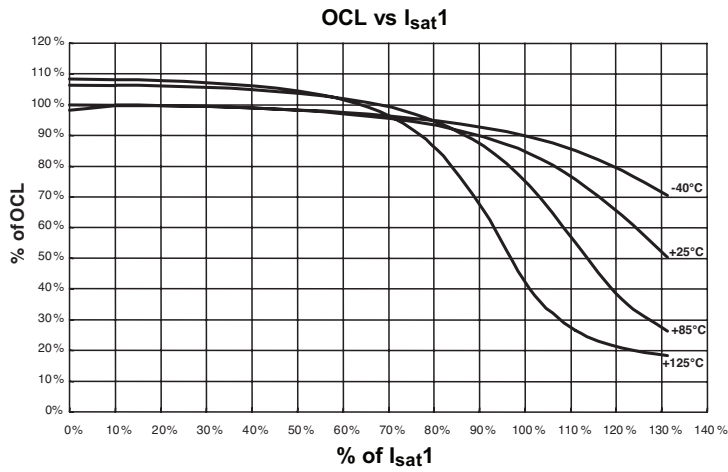

DRA74

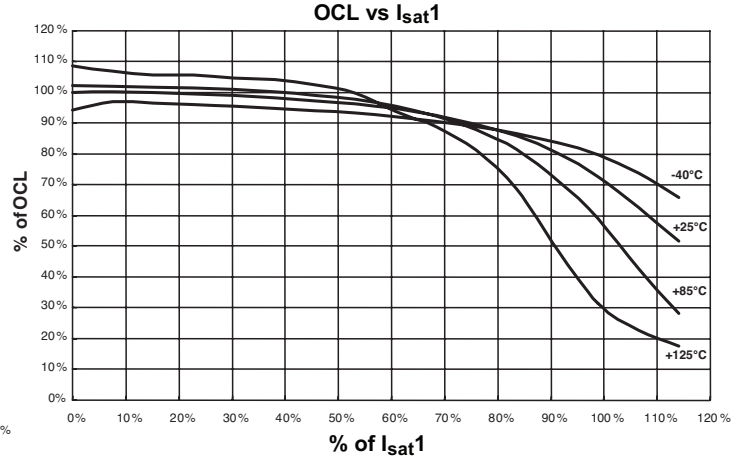

DRA124

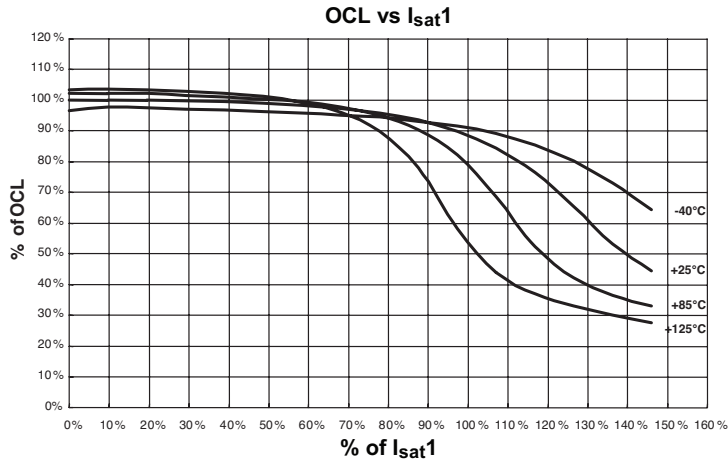

DRA125

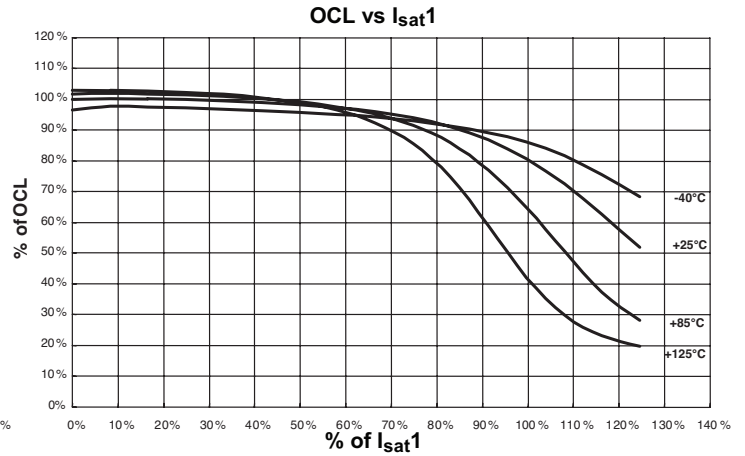

DRA127

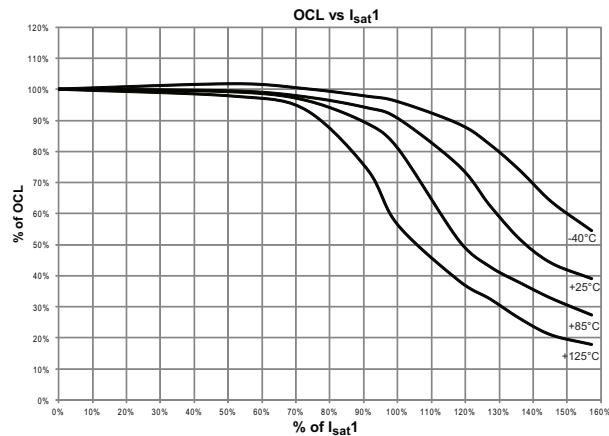

Dimensions - mm

DRA73 & DRA74

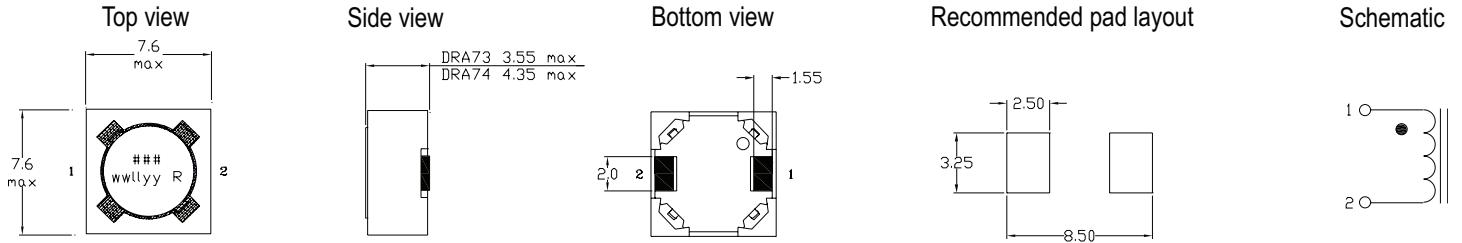

Part Marking: ### = inductance value in μH , R = decimal point; if no R is present, then 3rd digit equals number of zeros
wlllyy = Date code, R = revision level
All soldering surfaces to be coplanar within 0.10 millimeters
Tolerances are ± 0.2 millimeters unless stated otherwise.

DRA124, DRA125 & DRA127

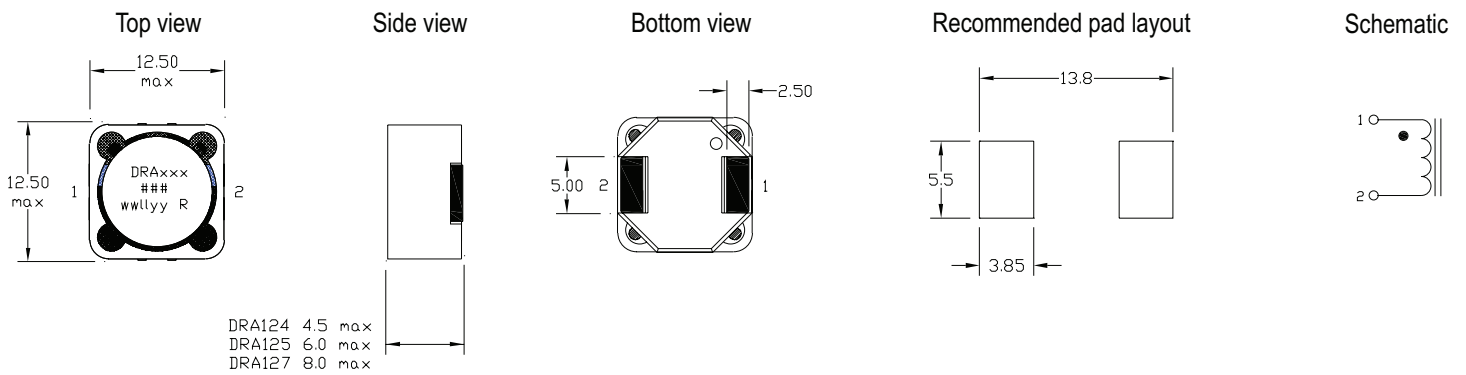

Part Marking: DRAxx, xx = 124, 125 or 127, ### = inductance value in μH , R = decimal point; if no R is present, then 3rd digit equals number of zeros
wlllyy = Date code, R = revision level
All soldering surfaces to be coplanar within 0.10 millimeters
Tolerances are ± 0.2 millimeters unless stated otherwise.

Packaging information - mm

DRA73 & DRA74

Supplied in tape and reel packaging, on a 13" diameter reel:

- DRA73 - 1350 pieces
- DRA74 - 1100 pieces

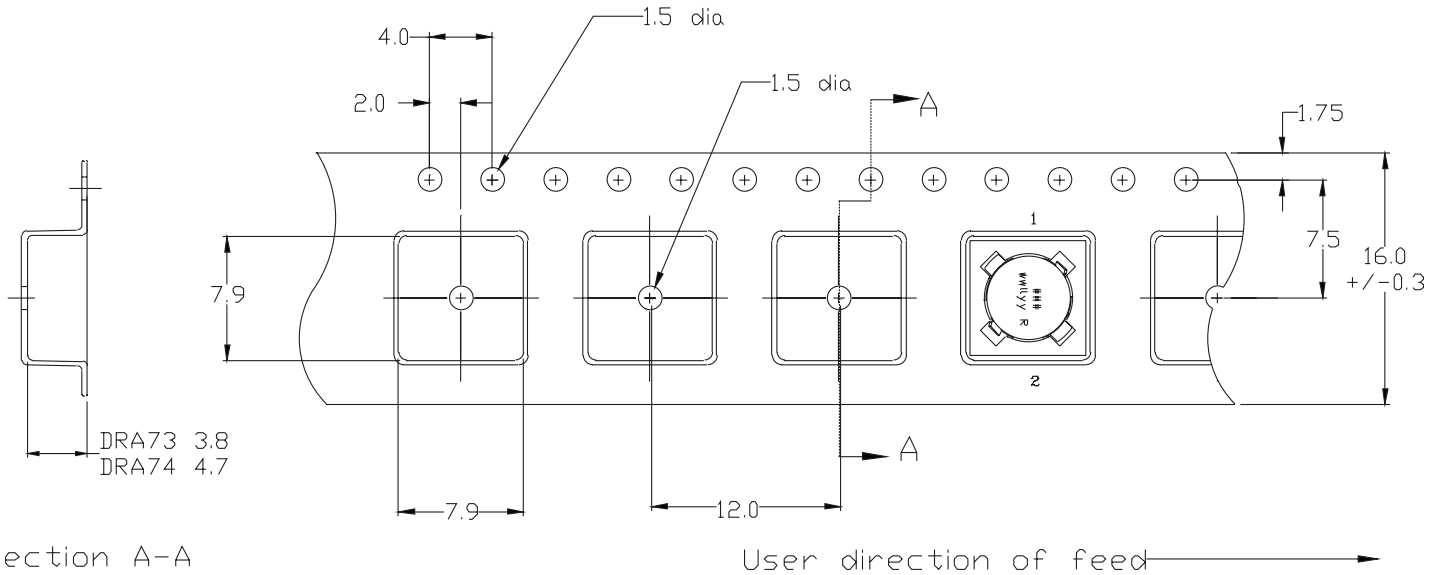

DRA124, DRA125 & DRA127

Supplied in tape and reel packaging, on a 13" diameter reel:

- DRA124 - 750 pieces
- DRA125 - 600 pieces
- DRA127 - 350 pieces

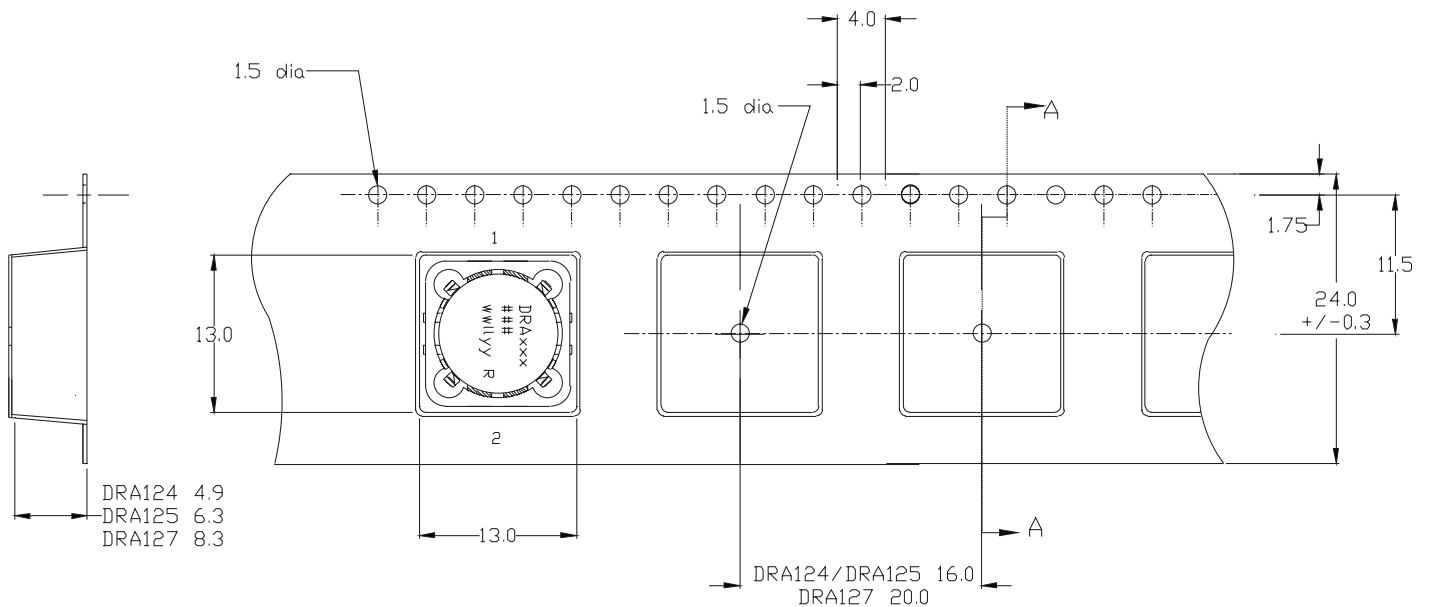

Solder reflow profile

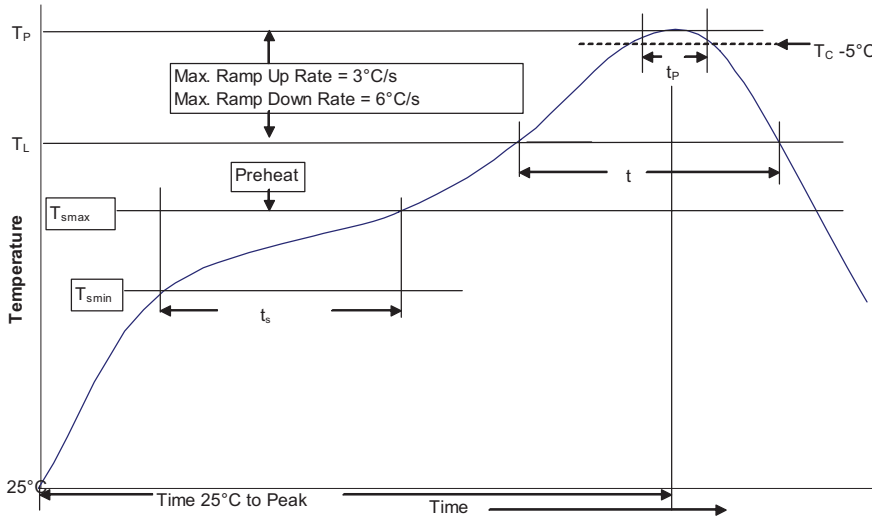

Table 1 - Standard SnPb Solder (T_C)

Package Thickness	Volume mm^3 <350	Volume mm^3 ≥ 350
<2.5mm	235°C	220°C
$\geq 2.5\text{mm}$	220°C	220°C

Table 2 - Lead (Pb) Free Solder (T_C)

Package Thickness	Volume mm^3 <350	Volume mm^3 350 - 2000	Volume mm^3 >2000
<1.6mm	260°C	260°C	260°C
1.6 – 2.5mm	260°C	250°C	245°C
>2.5mm	250°C	245°C	245°C

Reference JDEC J-STD-020D

Profile Feature	Standard SnPb Solder	Lead (Pb) Free Solder
Preheat and Soak		
• Temperature min. (T_{smin})	100°C	150°C
• Temperature max. (T_{smax})	150°C	200°C
• Time (T_{smin} to T_{smax}) (t_s)	60-120 Seconds	60-120 Seconds
Average ramp up rate T_{smax} to T_p	3°C/ Second Max.	3°C/ Second Max.
Liquidous temperature (T_L)	183°C	217°C
Time at liquidous (t_L)	60-150 Seconds	60-150 Seconds
Peak package body temperature (T_p)*	Table 1	Table 2
Time (t_p)** within 5 °C of the specified classification temperature (T_C)	20 Seconds**	30 Seconds**
Average ramp-down rate (T_p to T_{smax})	6°C/ Second Max.	6°C/ Second Max.
Time 25°C to Peak Temperature	6 Minutes Max.	8 Minutes Max.

* Tolerance for peak profile temperature (T_p) is defined as a supplier minimum and a user maximum.

** Tolerance for time at peak profile temperature (t_p) is defined as a supplier minimum and a user maximum.

North America

Eaton's Electrical Group
Electronics Division
1225 Broken Sound Parkway NW
Suite F
Boca Raton, FL 33487-3533
Tel: 1-561-998-4100
Fax: 1-561-241-6640
Toll Free: 1-888-414-2645

Eaton's Electrical Group
Electronics Division
P.O. Box 14460
St. Louis, MO 63178-4460
Tel: 1-636-394-2877
Fax: 1-636-527-1607

Europe

Eaton's Electrical Group
Electronics Division
Burton-on-the-Wolds
Leicestershire, LE 12 5th UK
Phone: +44 (0) 1509 882 600
Fax: +44 (0) 1509 882 786

Eaton's Electrical Group
Electronics Division
Avda Santa Eulalia, 290
Terrassa, Barcelona 08223 Spain
Phone: +34-93-736-2813
Fax: +34-93-783-5055

Asia Pacific

Eaton's Electrical Group
Electronics Division
No.2, #06-01
Serangoon North Avenue 5
Singapore 554911
Tel: +65 6645 9888
Fax: +65 6728 3155

The only controlled copy of this Data Sheet is the electronic read-only version located on the Bussmann Network Drive. All other copies of this document are by definition uncontrolled. This bulletin is intended to clearly present comprehensive product data and provide technical information that will help the end user with design applications. Bussmann reserves the right, without notice, to change design or construction of any products and to discontinue or limit distribution of any products. Bussmann also reserves the right to change or update, without notice, any technical information contained in this bulletin. Once a product has been selected, it should be tested by the user in all possible applications.

Life Support Policy: Bussmann does not authorize the use of any of its products for use in life support devices or systems without the express written approval of an officer of the Company. Life support systems are devices which support or sustain life, and whose failure to perform, when properly used in accordance with instructions for use provided in the labeling, can be reasonably expected to result in significant injury to the user.

**Eaton's Electrical Group
Electronics Division**
114 Old State Road
Ellisville, MO 63021
United States
www.eaton.com/elx

© 2014 Eaton
All Rights Reserved
Publication No. 4319 — BU-SB14110
January 2014

Eaton is a registered trademark.

All other trademarks are property of their respective owners.



Powering Business Worldwide

www.eaton.com/elx

AMEYA360

Components Supply Platform

Authorized Distribution Brand :



Website :

Welcome to visit www.ameya360.com

Contact Us :

➤ Address :

401 Building No.5, JiuGe Business Center, Lane 2301, Yishan Rd
Minhang District, Shanghai , China

➤ Sales :

Direct +86 (21) 6401-6692

Email amall@ameya360.com

QQ 800077892

Skype [ameyasales1](#) [ameyasales2](#)

➤ Customer Service :

Email service@ameya360.com

➤ Partnership :

Tel +86 (21) 64016692-8333

Email mkt@ameya360.com