

CoolMOS™ 1) Power MOSFET

with Series Schottky Diode and
Ultra Fast Antiparallel Diode

in High Voltage ISOPLUS i4-PAC™

$V_{DSS} = 600\text{ V}$
 $I_{D25} = 41\text{ A}$
 $R_{DS(on) \text{ typ.}} = 60\text{ m}\Omega$
 $t_{rr} = 70\text{ ns}$

Preliminary data

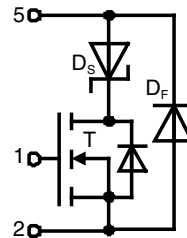

ISOPLUS i4-PAC™

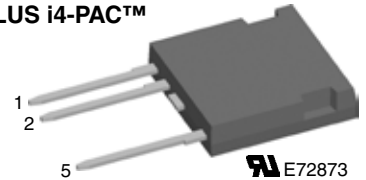

MOSFET T					
Symbol	Conditions	Maximum Ratings			
V_{DSS}	$T_{VJ} = 25^\circ\text{C to } 150^\circ\text{C}$	600	V		
V_{GS}		± 20	V		
I_{D25}	$T_C = 25^\circ\text{C}$	41	A		
I_{D90}	$T_C = 90^\circ\text{C}$	29	A		
Symbol	Conditions	Characteristic Values			
($T_{VJ} = 25^\circ\text{C}$, unless otherwise specified)					
		min.	typ.	max.	
R_{DSon}	MOSFET 'T' only:				
	$V_{GS} = 10\text{ V}; I_D = 25\text{ A}$		60	70	$\text{m}\Omega$
		$T_{VJ} = 25^\circ\text{C}$			
		$T_{VJ} = 125^\circ\text{C}$		135	$\text{m}\Omega$
	MOSFET 'T & D_S ' in series (pin 5, pin 2):				
	$V_{GS} = 10\text{ V}; I_D = 10\text{ A}$	$T_{VJ} = 25^\circ\text{C}$	120		$\text{m}\Omega$
	$T_{VJ} = 125^\circ\text{C}$	170		$\text{m}\Omega$	
	$V_{GS} = 10\text{ V}; I_D = 25\text{ A}$	$T_{VJ} = 25^\circ\text{C}$	85		$\text{m}\Omega$
	$T_{VJ} = 125^\circ\text{C}$	145		$\text{m}\Omega$	
$V_{GS(th)}$	$V_{DS} = 20\text{ V}; I_D = 3\text{ mA}$	2.1		3.9	V
I_{DSS}	$V_{DS} = V_{DSS}; V_{GS} = 0\text{ V}$			0.3	mA
			1		mA
I_{GSS}	$V_{GS} = \pm 20\text{ V}; V_{DS} = 0\text{ V}$			100	nA
Q_g	$V_{GS} = 10\text{ V}; V_{DS} = 350\text{ V}; I_D = 50\text{ A}$		250		nC
Q_{gs}			25		nC
Q_{gd}			120		nC
$t_{d(on)}$	Inductive load $V_{GS} = 10\text{ V}; V_{DS} = 380\text{ V}$ $I_D = 25\text{ A}; R_G = 10\ \Omega$	$T_{VJ} = 125^\circ\text{C}$		30	ns
t_r				18	ns
$t_{d(off)}$				500	ns
t_f				50	ns
E_{on}				0.7	mJ
E_{off}				0.3	mJ
$E_{rec(off)}$				0.22	mJ
R_{thJC}			with heatsink compound (IXYS test setup)		0.45
R_{thJH}	0.5	0.7		K/W	

Features

- fast CoolMOS™ 1) power MOSFET 3rd generation
 - high blocking voltage
 - low on resistance
 - low thermal resistance due to reduced chip thickness
- Series Schottky diode prevents current flow through MOSFET's body diode
 - very low forward voltage
 - fast switching
- Ultra fast HiPerFRED™ anti parallel diode
 - low operating forward voltage
 - fast and soft reverse recovery
 - low switching losses
- ISOPLUS i4-PAC™ high voltage package
 - isolated back surface
 - low coupling capacity between pins and heatsink
 - enlarged creepage towards heatsink
 - enlarged creepage betw. high voltage pins
 - application friendly pinout
 - high reliability
 - industry standard outline
 - UL registered E 72873

Applications

- Converters with
- circuit operation leading to current flow through switches in reverse direction - e. g.
 - phaseleg with inductive load
 - resonant circuits
 - high switching frequency

Examples

- switched mode power supplies (SMPS)
- uninterruptable power supplies (UPS)
- DC-DC converters
- welding converters
- converters for inductive heating
- drive converters

1) CoolMOS™ is a trademark of Infineon Technologies AG.

Series Schottky Diode D_s

Symbol	Conditions	Maximum Ratings		
I _{F25}	T _C = 25°C		77	A
I _{F90}	T _C = 90°C		45	A

Symbol	Conditions	Characteristic Values		
(T _{VJ} = 25°C, unless otherwise specified)				
		min.	typ.	max.
V _F	I _F = 20 A; T _C = 25°C			0.71
			0.5	V
	T _C = 125°C			V
V _{T0}	} T _{VJ} = 150°C for power loss calculation only			0.42
r _T				4.1
				mΩ
R _{thJC}	with heatsink compound (IXYS test setup)			2.2
R _{thJH}		2.8		3.5
				K/W
				K/W

Free Wheeling Diode D_F

Symbol	Conditions	Maximum Ratings		
I _{F25}	T _C = 25°C		40	A
I _{F90}	T _C = 90°C		23	A

Symbol	Conditions	Characteristic Values		
(T _{VJ} = 25°C, unless otherwise specified)				
		typ.	max.	
V _F	I _F = 30 A; T _C = 25°C	2.1	2.5	V
		1.4		V
	T _C = 125°C			
V _{T0}	} T _{VJ} = 150°C for power loss calculation only		1.0	V
r _T			17.3	mΩ
I _{RM}	} I _F = 25 A; di _F /dt = -400 A/μs; T _{VJ} = 125°C	15		A
t _{rr}		} V _R = 380 V; V _{GE} = 0 V	110	
R _{thJC}	with heatsink compound (IXYS test setup)		1.8	K/W
R _{thJH}		2.3	2.5	K/W

Component

Symbol	Conditions	Maximum Ratings		
T _{VJ}	operating		-40...+150	°C
T _{stg}	storage		-40...+125	°C
V _{ISOL}	I _{ISOL} = 1 mA, 50/60 Hz, t = 1 min		3000	V~
F _C	mounting force with clip		20-120	N

Symbol	Conditions	Characteristic Values		
		min.	typ.	max.
C _p	coupling capacity between shorted pins and mounting tab in the case		40	pF
d _s , d _A	D pin - S pin	7		mm
d _s , d _A	pin - backside metal	5.5		mm
Weight			6	g

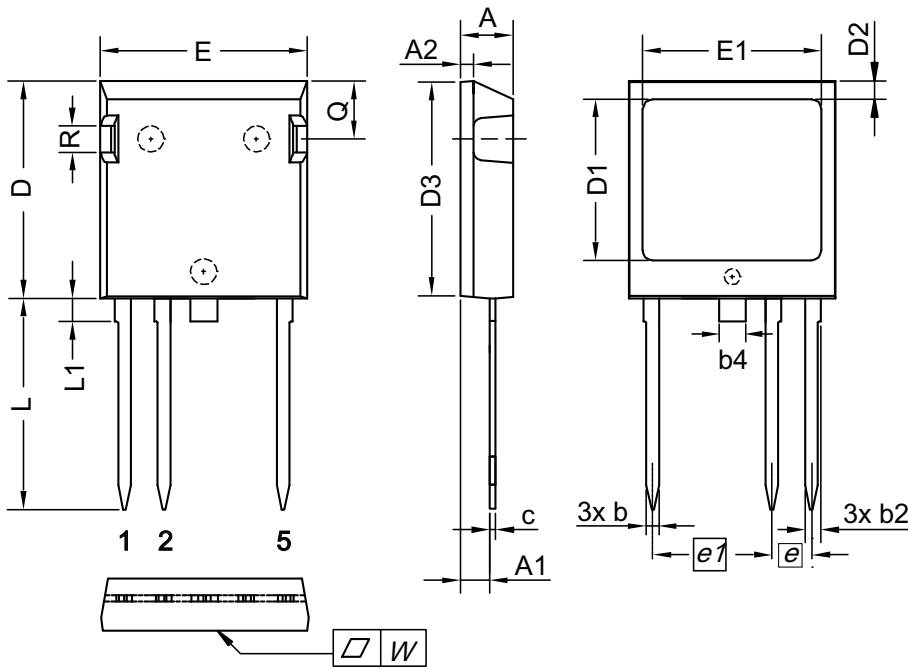
ISOPLUS i4-PAC™ Outline

Dim.	Millimeter		Inches	
	min	max	min	max
A	4.83	5.21	0.190	0.205
A1	2.59	3.00	0.102	0.118
A2	1.17	2.16	0.046	0.085
b	1.14	1.40	0.045	0.055
b2	1.47	1.73	0.058	0.068
b4	2.54	2.79	0.100	0.110
c	0.51	0.74	0.020	0.029
D	20.80	21.34	0.819	0.840
D1	14.99	15.75	0.590	0.620
D2	1.65	2.03	0.065	0.080
D3	20.30	20.70	0.799	0.815
E	19.56	20.29	0.770	0.799
E1	16.76	17.53	0.660	0.690
e	3.81 BSC		0.150 BSC	
e1	11.43 BSC		0.450 BSC	
L	19.81	21.34	0.780	0.840
L1	2.11	2.59	0.083	0.102
Q	5.33	6.20	0.210	0.244
R	2.54	4.57	0.100	0.180
W	-	0.10	-	0.004

Die konvexe Form des Substrates ist typ. < 0.05 mm über der Kunststoffoberfläche der Bauteilunterseite
 The convex bow of substrate is typ. < 0.05 mm over plastic surface level of device bottom side

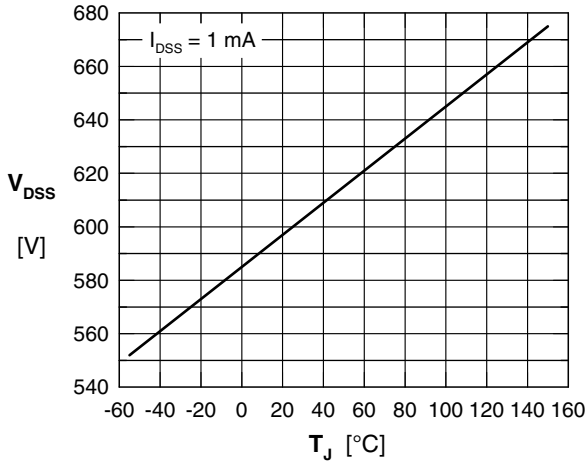

Fig. 1 Drain source breakdown voltage V_{DSS} vs. junction temperature T_J

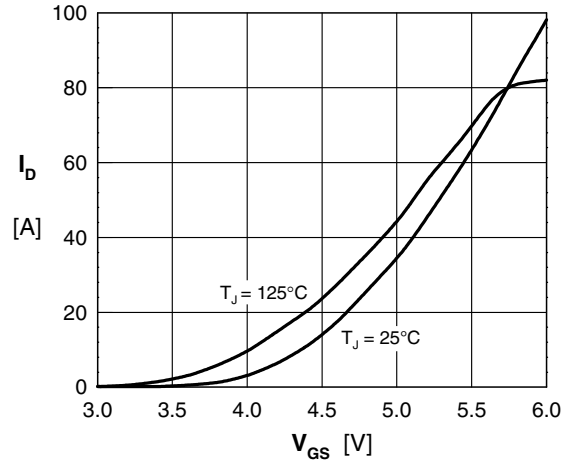

Fig. 2 Typical transfer characteristic

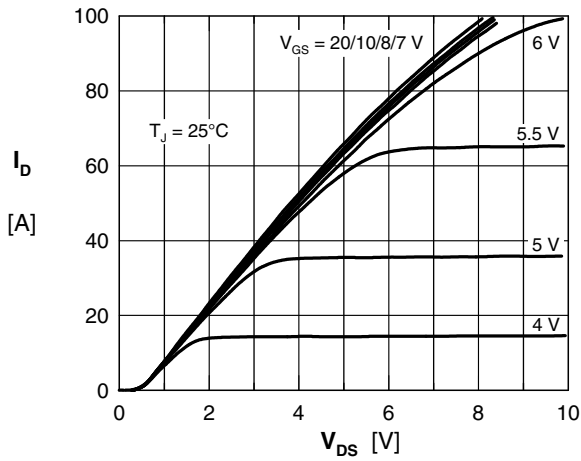

Fig. 3 Typical output characteristic (between pin 5 and pin 2)

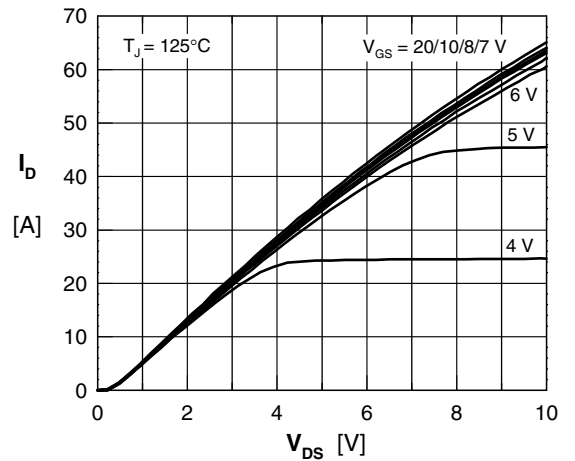

Fig. 4 Typical output characteristic (between pin 5 and pin 2)

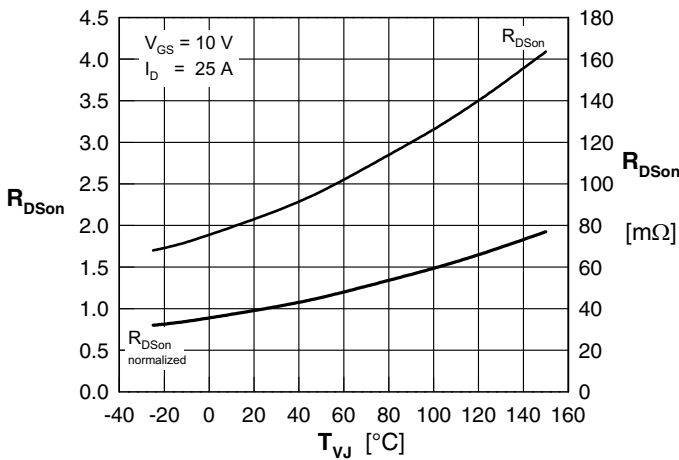

Fig. 5 Drain source on-state resistance $R_{DS(on)}$ versus junction temperature T_J (between pin 5 and pin 2)

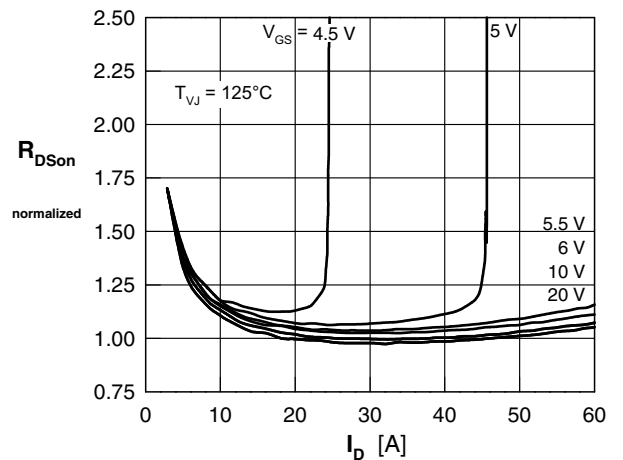

Fig. 6 Drain source on-state resistance $R_{DS(on)}$ versus I_D (between pin 5 and pin 2)

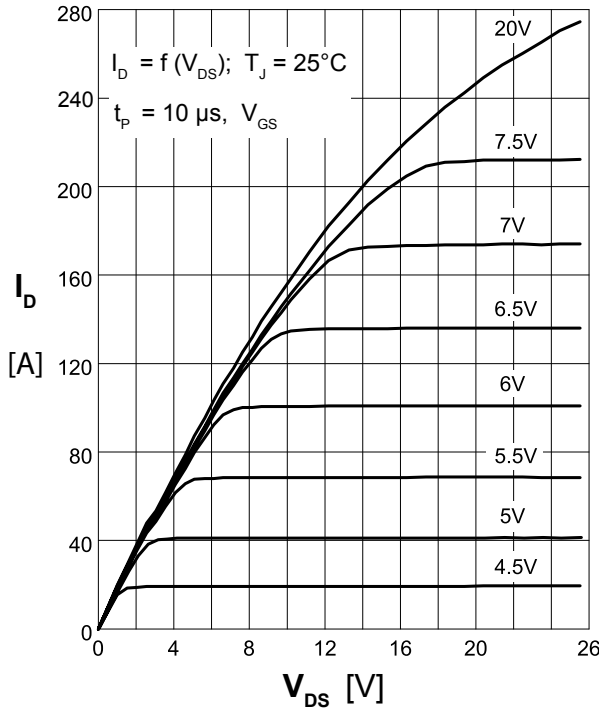

Fig. 7 Typical output characteristic (MOSFET only)

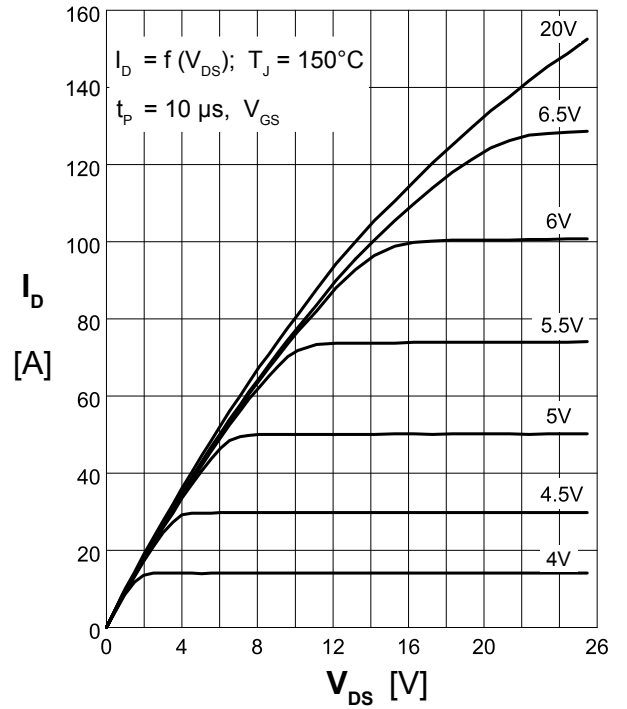

Fig. 8 Typical output characteristic (MOSFET only)

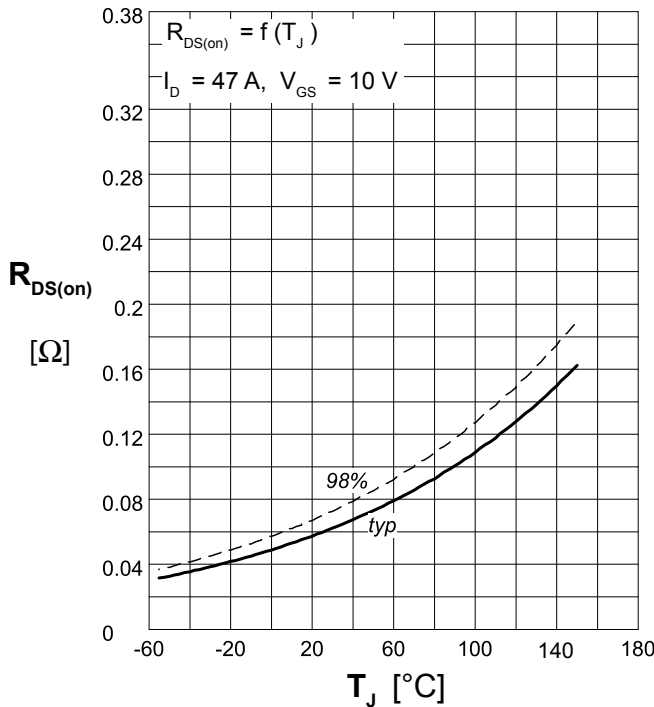

Fig. 9 Drain source on-state resistance $R_{DS(on)}$ versus junction temperature T_J (MOSFET only)

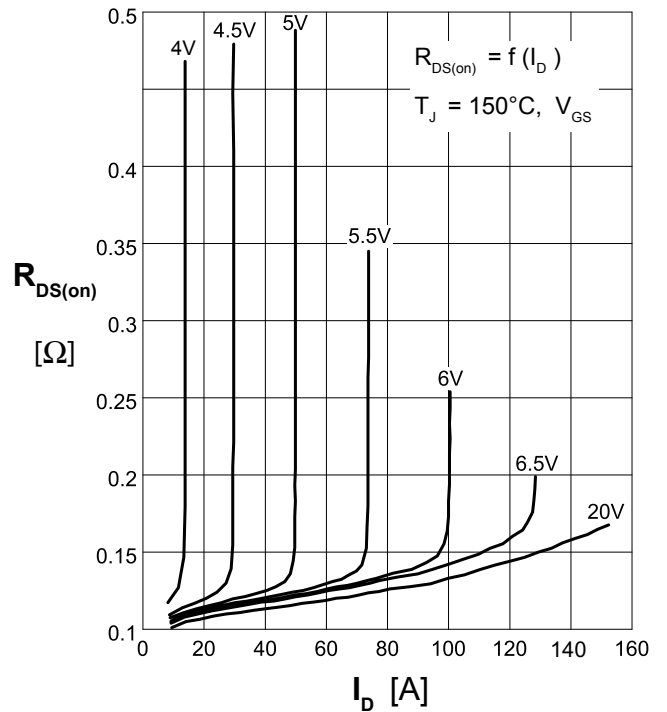

Fig. 10 Drain source on-state resistance $R_{DS(on)}$ versus I_D (MOSFET only)

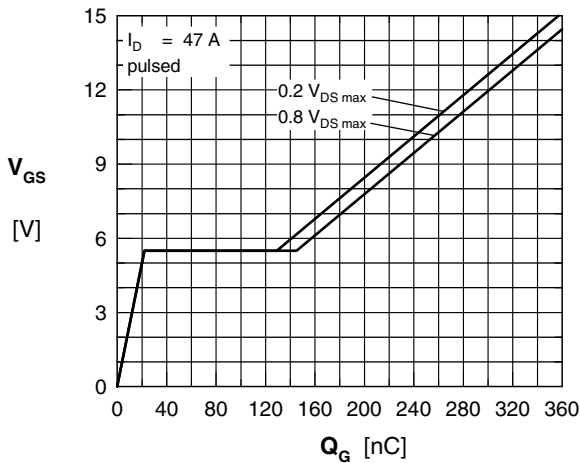

Fig. 11 Gate charge characteristic

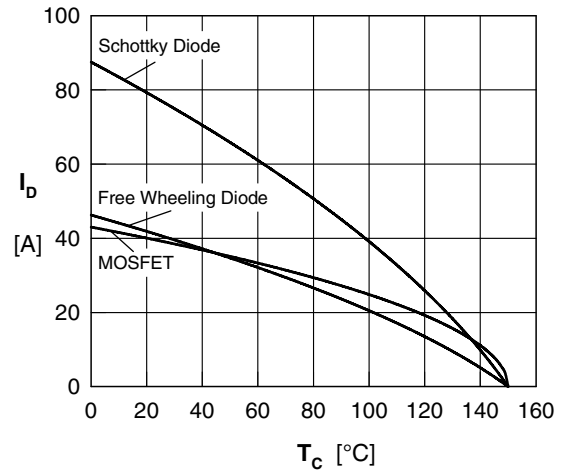

Fig. 12 Drain current I_D vs. case temperature T_C

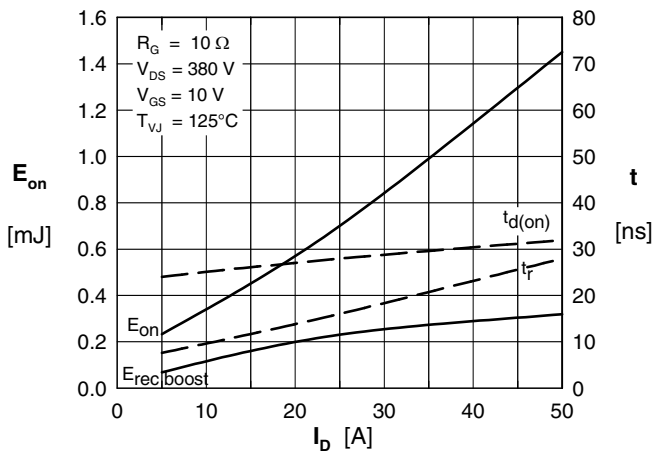

Fig. 13 Typ. turn-on energy & switching times vs. collector current, inductive switching

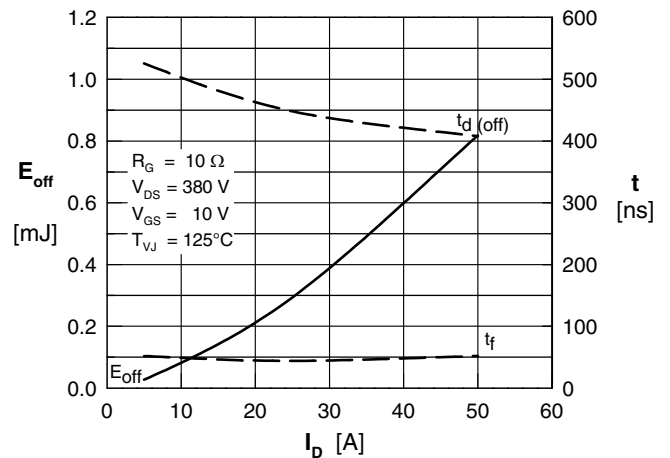

Fig. 14 Typ. turn-off energy & switching times vs. collector current, inductive switching

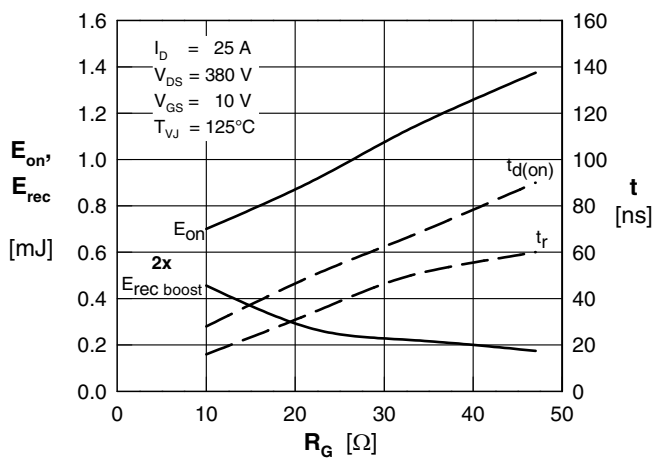

Fig. 15 Typ. turn-on energy & switching times vs. gate resistor, inductive switching

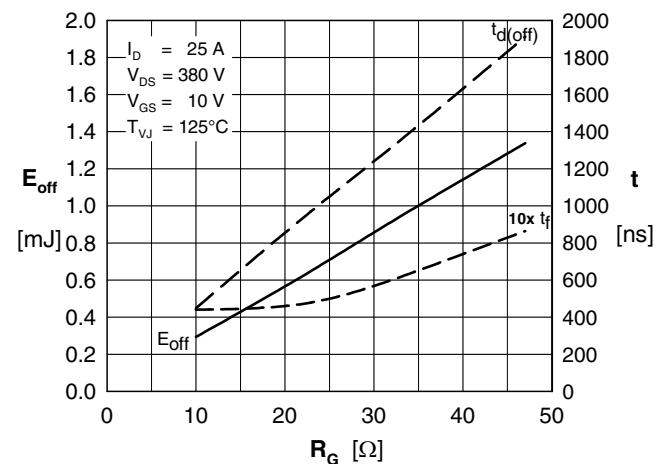

Fig. 16 Typ. turn-off energy & switching times vs. gate resistor, inductive switching

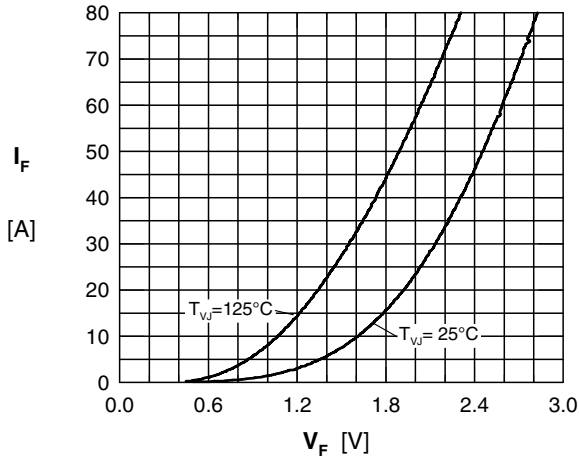

Fig. 17 Typ. forward characteristics of reverse diode

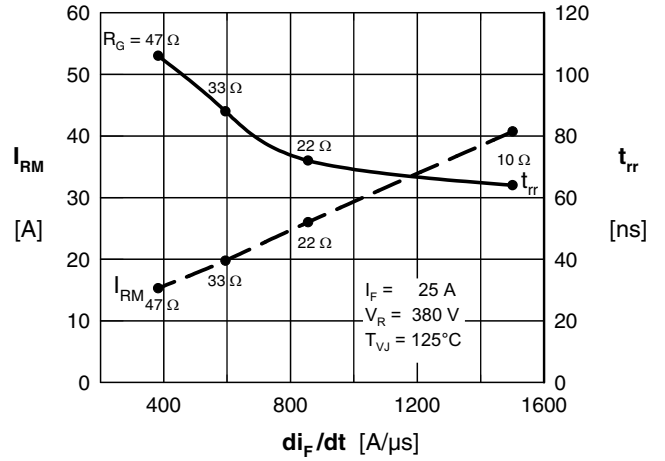

Fig. 18 Typ. reverse recovery characteristics of antiparallel diode

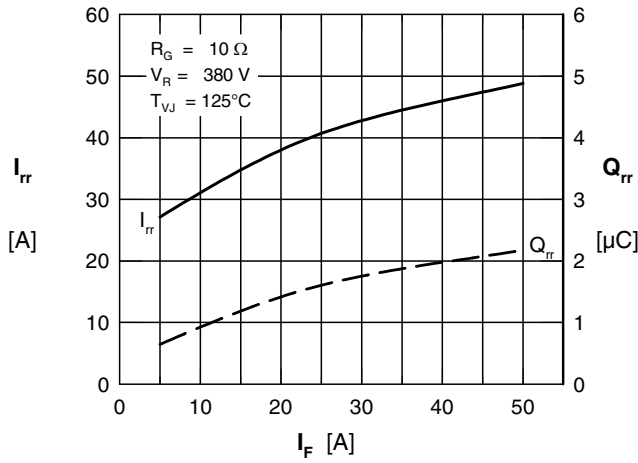

Fig. 19 Typ. reverse recovery characteristics

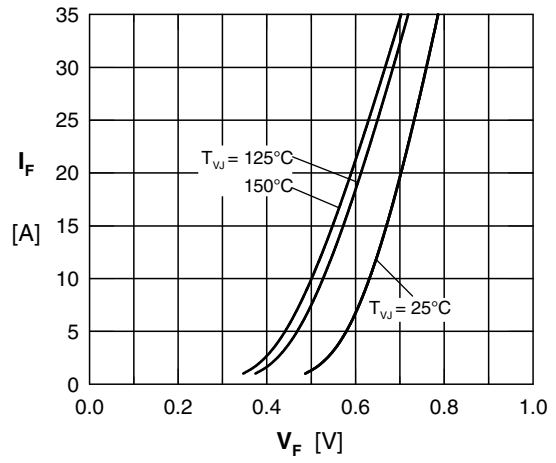

Fig. 20 Typ. forward characteristics of diode D_s

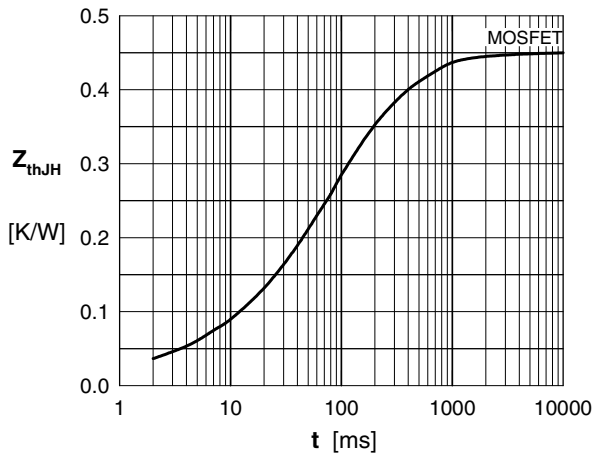

Fig. 21 Typ. thermal impedance junction to heatsink Z_{thJH} of the MOSFET with heat transfer paste

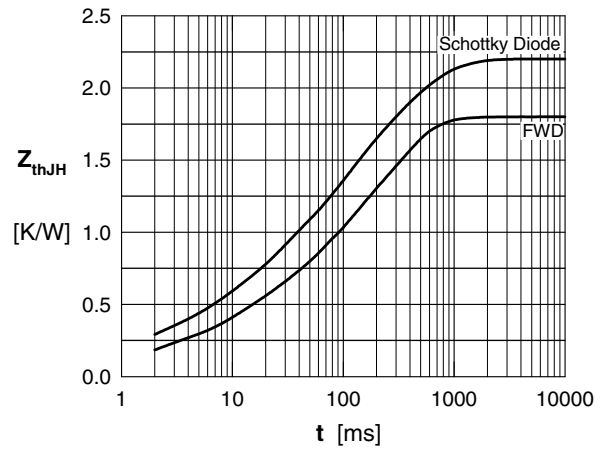

Fig. 22 Typ. thermal impedance junction to heatsink Z_{thJH} of the Diodes with heat transfer paste

AMEYA360

Components Supply Platform

Authorized Distribution Brand :



Website :

Welcome to visit www.ameya360.com

Contact Us :

➤ Address :

401 Building No.5, JiuGe Business Center, Lane 2301, Yishan Rd
Minhang District, Shanghai , China

➤ Sales :

Direct +86 (21) 6401-6692

Email amall@ameya360.com

QQ 800077892

Skype [ameyasales1](#) [ameyasales2](#)

➤ Customer Service :

Email service@ameya360.com

➤ Partnership :

Tel +86 (21) 64016692-8333

Email mkt@ameya360.com