

Features

- Low Forward Voltage Drop
- Guard Ring Construction for Transient Protection
- Negligible Reverse Recovery Time
- Low Capacitance
- Ultra-small Surface Mount Package
- **Lead Free/RoHS Compliant Version (Note 1)**
- **“Green” Device (Note 2)**

Mechanical Data

- Case: SOD323
- Case Material: Molded Plastic. UL Flammability Classification Rating 94V-0
- Moisture Sensitivity: Level 1 per J-STD-020
- Polarity: Cathode Band
- Leads: Matte Tin Finish annealed over Alloy 42 leadframe (Lead Free Plating). Solderable per MIL-STD-202, Method 208
- Weight: 0.004 grams (approximate)



Top View

Ordering Information (Note 3)

Part Number	Case	Packaging
SD101AWS-7-F	SOD323	3000/Tape & Reel
SD101BWS-7-F	SOD323	3000/Tape & Reel
SD101CWS-7-F	SOD323	3000/Tape & Reel

- Notes:
1. No purposefully added lead.
 2. Diodes Inc.'s "Green" policy can be found on our website at <http://www.diodes.com/>
 3. For packaging details, go to our website at <http://www.diodes.com>.

Marking Information

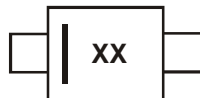

xx = Product Type Marking Code
 S1 or SK = SD101AWS
 S2 or SK = SD101BWS
 S3 or SC or SK = SD101CWS

Maximum Ratings @T_A = 25°C unless otherwise specified

Characteristic	Symbol	SD101AWS	SD101BWS	SD101CWS	Unit
Peak Repetitive Reverse Voltage	V _{RRM}				
Working Peak Reverse Voltage	V _{RWM}	60	50	40	V
DC Blocking Voltage	V _R				
RMS Reverse Voltage	V _{R(RMS)}	42	35	28	V
Forward Continuous Current (Note 4)	I _{FM}		15		mA
Non-Repetitive Peak Forward Surge Current	I _{FSM}		50		mA
	@ t ≤ 1.0s		2.0		
	@ t = 10μs				

Thermal Characteristics

Characteristic	Symbol	Value	Unit
Power Dissipation (Note 4)	P _D	200	mW
Thermal Resistance, Junction to Ambient Air (Note 4)	R _{θJA}	625	°C/W
Operating and Storage Temperature Range	T _J , T _{STG}	-65 to +125	°C

Electrical Characteristics @T_A = 25°C unless otherwise specified

Characteristic	Symbol	Min	Typ	Max	Unit	Test Conditions
Reverse Breakdown Voltage (Note 5)	SD101AWS	60	—	—	V	I _R = 10μA
	SD101BWS	50	—	—		I _R = 10μA
	SD101CWS	40	—	—		I _R = 10μA
Forward Voltage Drop	SD101AWS	—	—	0.41	V	I _F = 1.0mA
	SD101BWS	—	—	0.40		I _F = 1.0mA
	SD101CWS	—	—	0.39		I _F = 1.0mA
	SD101AWS	—	—	1.00		I _F = 15mA
	SD101BWS	—	—	0.95		I _F = 15mA
	SD101CWS	—	—	0.90		I _F = 15mA
Peak Reverse Current (Note 5)	SD101AWS	—	—	200	nA	V _R = 50V
	SD101BWS	—	—	200		V _R = 40V
	SD101CWS	—	—	200		V _R = 30V
Total Capacitance	SD101AWS	—	—	2.0	pF	V _R = 0V, f = 1.0MHz
	SD101BWS	—	—	2.1		V _R = 0V, f = 1.0MHz
	SD101CWS	—	—	2.2		V _R = 0V, f = 1.0MHz
Reverse Recovery Time	t _{rr}	—	—	1.0	ns	I _F = I _R = 5.0mA, I _{rr} = 0.1 x I _R , R _L = 100Ω

Notes: 4. Part mounted on FR-4 PC board with recommended pad layout, which can be found on our website at <http://www.diodes.com>.
5. Short duration pulse test used to minimize self-heating effect.

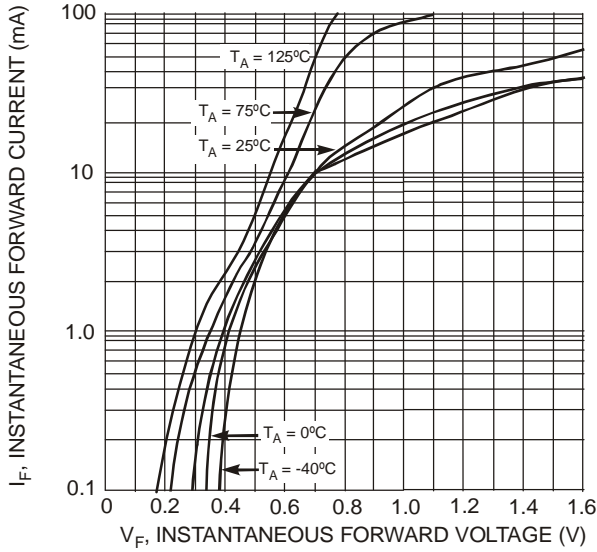

Fig. 1 Typical Forward Characteristics

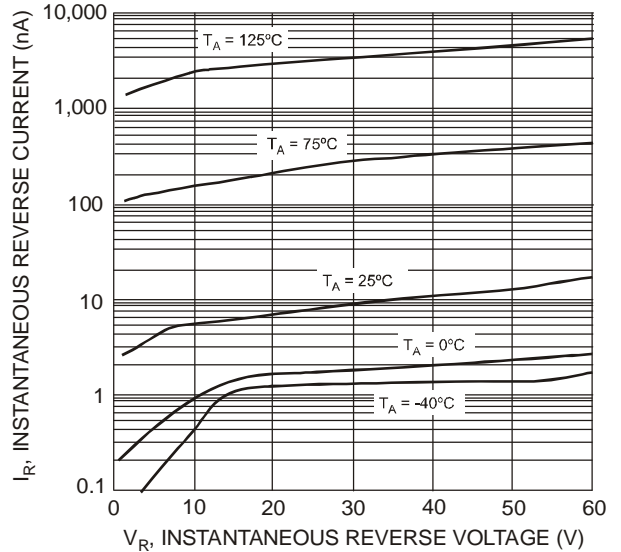

Fig. 2 Typical Reverse Characteristics

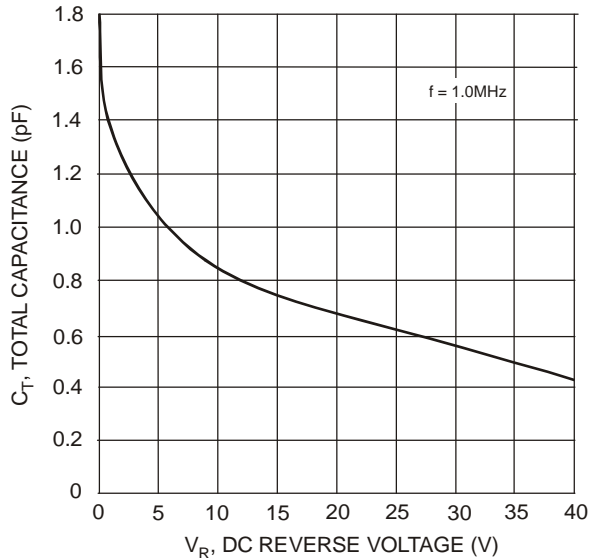

Fig. 3 Total Capacitance vs. Reverse Voltage

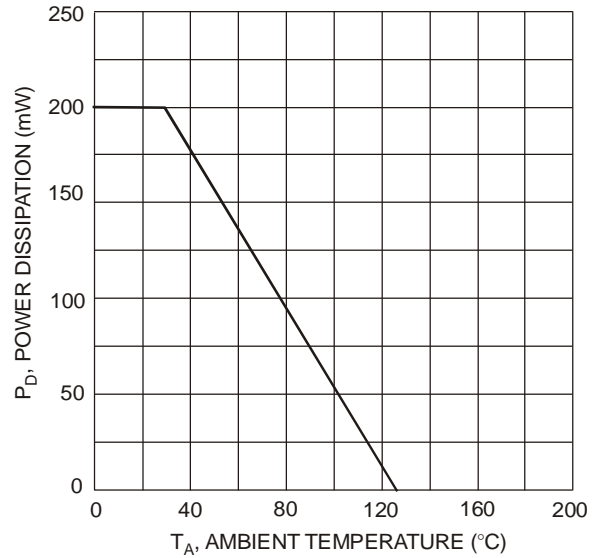
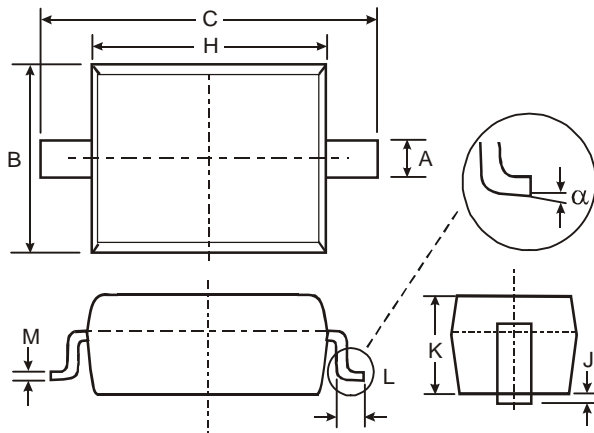

Fig. 4 Power Derating Curve

Package Outline Dimensions



SOD323		
Dim	Min	Max
A	0.25	0.35
B	1.20	1.40
C	2.30	2.70
H	1.60	1.80
J	0.00	0.10
K	1.0	1.1
L	0.20	0.40
M	0.10	0.15
α	0°	8°
All Dimensions in mm		

Suggested Pad Layout

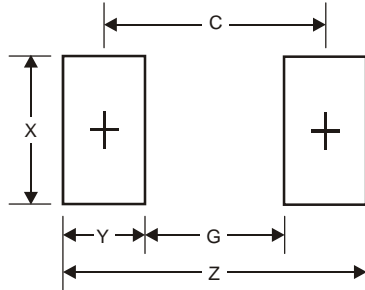

Dimensions	Value (in mm)
Z	3.75
G	1.05
X	0.65
Y	1.35
C	2.40

IMPORTANT NOTICE

DIODES INCORPORATED MAKES NO WARRANTY OF ANY KIND, EXPRESS OR IMPLIED, WITH REGARDS TO THIS DOCUMENT, INCLUDING, BUT NOT LIMITED TO, THE IMPLIED WARRANTIES OF MERCHANTABILITY AND FITNESS FOR A PARTICULAR PURPOSE (AND THEIR EQUIVALENTS UNDER THE LAWS OF ANY JURISDICTION).

Diodes Incorporated and its subsidiaries reserve the right to make modifications, enhancements, improvements, corrections or other changes without further notice to this document and any product described herein. Diodes Incorporated does not assume any liability arising out of the application or use of this document or any product described herein; neither does Diodes Incorporated convey any license under its patent or trademark rights, nor the rights of others. Any Customer or user of this document or products described herein in such applications shall assume all risks of such use and will agree to hold Diodes Incorporated and all the companies whose products are represented on Diodes Incorporated website, harmless against all damages.

Diodes Incorporated does not warrant or accept any liability whatsoever in respect of any products purchased through unauthorized sales channel. Should Customers purchase or use Diodes Incorporated products for any unintended or unauthorized application, Customers shall indemnify and hold Diodes Incorporated and its representatives harmless against all claims, damages, expenses, and attorney fees arising out of, directly or indirectly, any claim of personal injury or death associated with such unintended or unauthorized application.

Products described herein may be covered by one or more United States, international or foreign patents pending. Product names and markings noted herein may also be covered by one or more United States, international or foreign trademarks.

LIFE SUPPORT

Diodes Incorporated products are specifically not authorized for use as critical components in life support devices or systems without the express written approval of the Chief Executive Officer of Diodes Incorporated. As used herein:

A. Life support devices or systems are devices or systems which:

1. are intended to implant into the body, or
2. support or sustain life and whose failure to perform when properly used in accordance with instructions for use provided in the labeling can be reasonably expected to result in significant injury to the user.

B. A critical component is any component in a life support device or system whose failure to perform can be reasonably expected to cause the failure of the life support device or to affect its safety or effectiveness.

Customers represent that they have all necessary expertise in the safety and regulatory ramifications of their life support devices or systems, and acknowledge and agree that they are solely responsible for all legal, regulatory and safety-related requirements concerning their products and any use of Diodes Incorporated products in such safety-critical, life support devices or systems, notwithstanding any devices- or systems-related information or support that may be provided by Diodes Incorporated. Further, Customers must fully indemnify Diodes Incorporated and its representatives against any damages arising out of the use of Diodes Incorporated products in such safety-critical, life support devices or systems.

Copyright © 2012, Diodes Incorporated

www.diodes.com

AMEYA360

Components Supply Platform

Authorized Distribution Brand :



Website :

Welcome to visit www.ameya360.com

Contact Us :

➤ Address :

401 Building No.5, JiuGe Business Center, Lane 2301, Yishan Rd
Minhang District, Shanghai , China

➤ Sales :

Direct +86 (21) 6401-6692

Email amall@ameya360.com

QQ 800077892

Skype [ameyasales1](#) [ameyasales2](#)

➤ Customer Service :

Email service@ameya360.com

➤ Partnership :

Tel +86 (21) 64016692-8333

Email mkt@ameya360.com