

NCP81051

IMVP7.0 Compatible Synchronous Buck MOSFET Driver

The NCP81051 is a high performance dual MOSFET gate driver optimized to drive the gates of both high-side and low-side power MOSFETs in a synchronous buck converter. It can drive up to 3 nF load with a 25 ns propagation delay and 20 ns transition time.

Adaptive anti-cross-conduction and power saving operation circuit can provide a low switching loss and high efficiency solution for notebook systems.

The UVLO function guarantees the outputs are low when the supply voltage is low.

Features

- Faster Rise and Fall Times
- Adaptive Anti-Cross-Conduction Circuit
- Zero Cross Detection function
- Output Disable Control Turns Off Both MOSFETs
- Undervoltage Lockout
- Power Saving Operation Under Light Load Conditions
- Direct Interface to NCP6131 and Other Compatible PWM Controllers
- Thermally Enhanced Package
- These Devices are Pb-Free and are RoHS Compliant*

Typical Applications

- Power Management Solutions for Notebook systems



ON Semiconductor®

<http://onsemi.com>

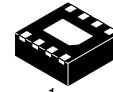

DFN8
CASE 506AA

MARKING DIAGRAM

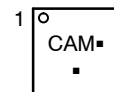

CA = Specific Device Code

M = Date Code

▪ = Pb-Free Package

(Note: Microdot may be in either location)

PINOUT DIAGRAM

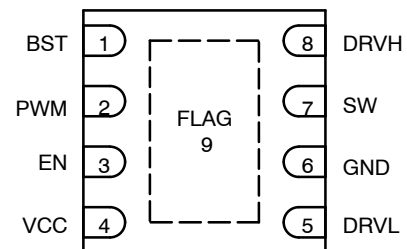

ORDERING INFORMATION

Device	Package	Shipping†
NCP81051MNTBG	DFN8 (Pb-Free)	3000 / Tape & Reel

†For information on tape and reel specifications, including part orientation and tape sizes, please refer to our Tape and Reel Packaging Specifications Brochure, BRD8011/D.

*For additional information on our Pb-Free strategy and soldering details, please download the ON Semiconductor Soldering and Mounting Techniques Reference Manual, SOLDERRM/D.

NCP81051

ABSOLUTE MAXIMUM RATINGS

ELECTRICAL INFORMATION

Symbol	Pin Name	V _{MAX}	V _{MIN}
V _{CC}	Main Supply Voltage Input	6.5 V	-0.3 V
BST	Bootstrap Supply Voltage	35 V wrt/ GND 40 V ≤ 50 ns wrt/ GND 6.5 V wrt/ SW	-0.3 V wrt/SW
SW	Switching Node (Bootstrap Supply Return)	35 V 40 V ≤ 50 ns	-5 V -10 V (200 ns)
DRVH	High Side Driver Output	BST + 0.3 V	-0.3 V wrt/SW -2 V (< 200 ns) wrt/SW
DRVL	Low Side Driver Output	V _{CC} + 0.3 V	-0.3 V DC -5 V (< 200 ns)
PWM	DRVH and DRVL Control Input	6.5 V	-0.3 V
EN	Enable Pin	6.5 V	-0.3 V
GND	Ground	0 V	0 V

Stresses exceeding Maximum Ratings may damage the device. Maximum Ratings are stress ratings only. Functional operation above the Recommended Operating Conditions is not implied. Extended exposure to stresses above the Recommended Operating Conditions may affect device reliability.

*All signals referenced to AGND unless noted otherwise.

THERMAL INFORMATION

Symbol	Parameter	Value	Unit
R _{θJA}	Thermal Characteristic QFN Package (Note 1)	119	°C/W
T _J	Operating Junction Temperature Range (Note 2)	0 to 150	°C
T _A	Operating Ambient Temperature Range	-40 to +100	°C
T _{STG}	Maximum Storage Temperature Range	-55 to +150	°C
MSL	Moisture Sensitivity Level – QFN Package	1	

*The maximum package power dissipation must be observed.

- 1 in² Cu, 1 oz. thickness.
- JESD 51-7 (1S2P Direct-Attach Method) with 1 LFM.

NCP81051

NCP81051 ELECTRICAL CHARACTERISTICS ($-40^{\circ}\text{C} < T_A < +100^{\circ}\text{C}$; $4.5\text{ V} < V_{\text{CC}} < 5.5\text{ V}$, $4.5\text{ V} < \text{BST-SWN} < 5.5\text{ V}$, $4.5\text{ V} < \text{BST} < 30\text{ V}$, $0\text{ V} < \text{SWN} < 21\text{ V}$, unless otherwise noted)

Parameter	Test Conditions	Min	Typ	Max	Unit
-----------	-----------------	-----	-----	-----	------

SUPPLY VOLTAGE

VCC Operation Voltage		4.5		5.5	V
-----------------------	--	-----	--	-----	---

UNDERVOLTAGE LOCKOUT

VCC Start Threshold		3.8	4.35	4.5	V
VCC UVLO Hysteresis		150	200	250	mV

SUPPLY CURRENT

Shutdown Mode	$I_{\text{CC}} + I_{\text{BST}}$, EN = GND		15	30	μA
Normal Mode	$I_{\text{CC}} + I_{\text{BST}}$, EN = 5 V, PWM = OSC		5.0		mA
Standby Current	$I_{\text{CC}} + I_{\text{BST}}$, EN = HIGH, PWM = LOW, No loading on DRVH & DRVL		0.9		mA
Standby Current	$I_{\text{CC}} + I_{\text{BST}}$, EN = HIGH, PWM = HIGH, No loading on DRVH & DRVL		1.1		mA

BOOTSTRAP DIODE

Forward Voltage	$V_{\text{CC}} = 5\text{ V}$, forward bias current = 2 mA	0.1	0.4	0.6	V
-----------------	--	-----	-----	-----	---

PWM INPUT

PWM Input High		3.4			V
PWM Mid-State		1.3		2.7	V
PWM Input Low				0.7	V
ZCD Blanking Timer			350		ns

HIGH SIDE DRIVER

Output Impedance, Sourcing Current	$V_{\text{BST}} - V_{\text{SW}} = 5\text{ V}$		0.9	2.0	Ω
Output Impedance, Sinking Current	$V_{\text{BST}} - V_{\text{SW}} = 5\text{ V}$		0.7	2.0	Ω
DRVH Rise Time t_{rDRVH}	$V_{\text{CC}} = 5\text{ V}$, 3 nF load, $V_{\text{BST}} - V_{\text{SW}} = 5\text{ V}$		16	25	ns
DRVH Fall Time t_{fDRVH}	$V_{\text{CC}} = 5\text{ V}$, 3 nF load, $V_{\text{BST}} - V_{\text{SW}} = 5\text{ V}$		11	18	ns
DRVH Turn-Off Propagation Delay $t_{\text{pd}1\text{DRVH}}$	$C_{\text{LOAD}} = 3\text{ nF}$	10		30	ns
DRVH Turn-On Propagation Delay $t_{\text{pd}h\text{DRVH}}$	$C_{\text{LOAD}} = 3\text{ nF}$	15		45	ns
SW Pulldown Resistance	SW to PGND		45		k Ω
DRVH Pulldown Resistance	DRVH to SW, BST-SW = 0 V		45		k Ω

LOW SIDE DRIVER

Output Impedance, Sourcing Current			0.9	2.0	Ω
Output Impedance, Sinking Current			0.4	1.0	Ω
DRVL Rise Time t_{rDRVL}	$C_{\text{LOAD}} = 3\text{ nF}$		16	25	ns
DRVL Fall Time t_{fDRVL}	$C_{\text{LOAD}} = 3\text{ nF}$		11	15	ns
DRVL Turn-Off Propagation Delay $t_{\text{pd}1\text{DRVL}}$	$C_{\text{LOAD}} = 3\text{ nF}$	10		30	ns
DRVL Turn-On Propagation Delay $t_{\text{pd}h\text{DRVL}}$	$C_{\text{LOAD}} = 3\text{ nF}$	5.0		25	ns
DRVL Pulldown Resistance	DRVL to PGND, $V_{\text{CC}} = \text{PGND}$		45		k Ω

NCP81051

NCP81051 ELECTRICAL CHARACTERISTICS ($-40^{\circ}\text{C} < T_A < +100^{\circ}\text{C}$; $4.5\text{ V} < V_{CC} < 5.5\text{ V}$, $4.5\text{ V} < \text{BST-SWN} < 5.5\text{ V}$, $4.5\text{ V} < \text{BST} < 30\text{ V}$, $0\text{ V} < \text{SWN} < 21\text{ V}$, unless otherwise noted)

Parameter	Test Conditions	Min	Typ	Max	Unit
EN INPUT					
Input Voltage High		3.3			V
Input Voltage Mid		1.35		1.8	V
Input Voltage Low				0.6	V
Input bias current		-1.0		1.0	μA
Propagation Delay Time			20	40	ns
SW NODE					
SW Node Leakage Current				20	μA
Zero Cross Detection Threshold Voltage			-6.0		mV

NCP81051

Table 1. DECODER TRUTH TABLE

Input	ZCD	DRVL	DRVH
PWM High (Enable High)	ZCD Reset	Low	High
PWM Mid (Enable High)	Positive Current Through the Inductor	High	Low
PWM Mid (Enable High)	Zero Current Through the Inductor	Low	Low
PWM Low (Enable High)	ZCD Reset	High	Low
Enable at Mid	X	Low	Low

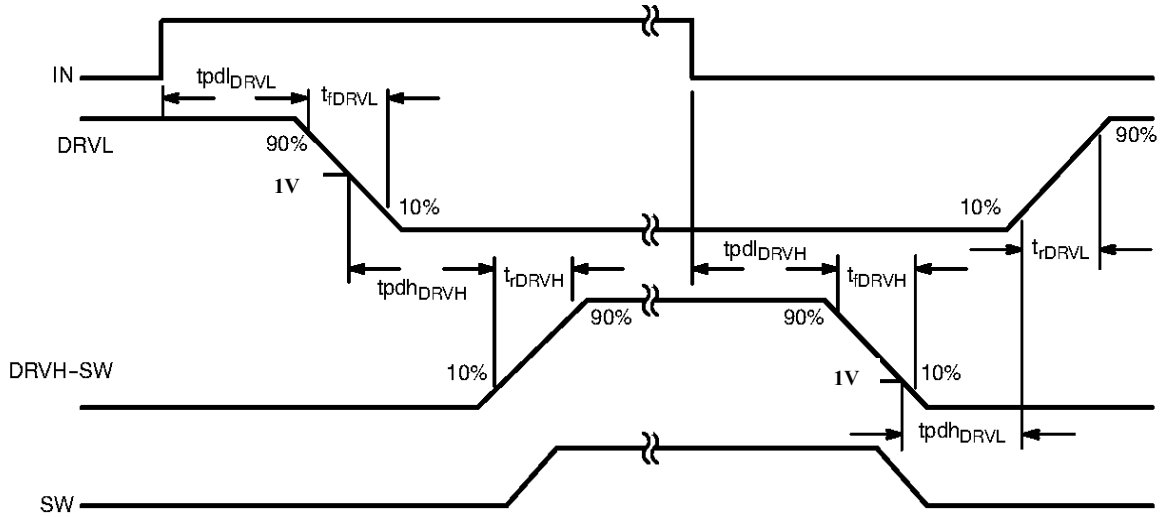

Figure 3.

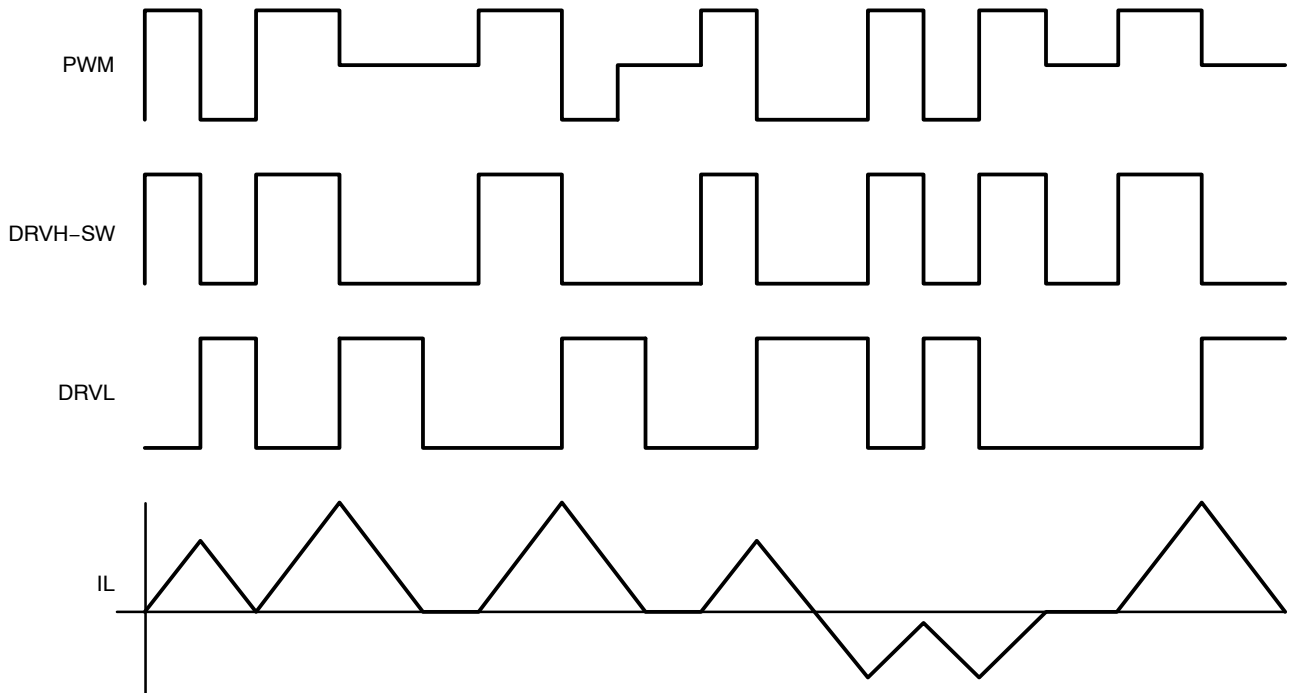

Figure 4. Timing Diagram

APPLICATION INFORMATION

The NCP81051 gate driver is a single phase MOSFET driver designed for driving N-channel MOSFETs in a synchronous buck converter topology. The NCP81051 is designed to work with ON Semiconductor’s NCP6131 multi-phase controller. This gate driver is optimized for notebook applications.

Undervoltage Lockout

DRVH and DRVL are held low until VCC reaches 4.5 V during startup. The PWM signal will control the gate status when VCC threshold is exceeded.

Three-State EN Signal

When EN is set to the mid state, both DRVH and DRVL are set low, to force diode mode operation.

PWM Input and Zero Cross Detect (ZCD)

The PWM input, along with EN and ZCD, control the state of DRVH and DRVL.

When PWM is set high, DRVH will be set high after the adaptive non-overlap delay. When PWM is set low, DRVL will be set high after the adaptive non-overlap delay.

When PWM is set to the mid state, DRVH will be set low, and after the adaptive non-overlap delay, DRVL will be set high. DRVL remains high during the ZCD blanking time. When the timer has expired, the SW pin will be monitored for zero cross detection. After the detection, DRVL will be set low.

Adaptive Non-overlap

Adaptive dead time control is used to avoid shoot-through damage of the power MOSFETs. When the PWM signal pulls high, DRVL will be set low and the driver will monitor the gate voltage of the low side MOSFET. When the DRVL voltage falls below the gate threshold, DRVH will be set to

high after the tpdhDRVH delay. When PWM is set low, the driver will monitor the gate voltage of the high side MOSFET. When the DRVH-SWN voltage falls below the top gate drive threshold, DRVL will be set to high after the tpdhDRVL delay.

Layout Guidelines

The layout for a DC-DC converter is very important. The bootstrap and VCC bypass capacitors should be placed close to the driver IC.

Connect the GND pin to a local ground plane. The ground plane can provide a good return path for gate drives and reduce the ground noise. The thermal slug should be tied to the ground plane for good heat dissipation. To minimize the ground loop for the low side MOSFET, the driver GND pin should be close to the low-side MOSFET source pin. The gate drive trace should be routed to minimize its length. The minimum width is 20 mils.

Gate Driver Power Loss Calculation

The gate driver power loss consists of the gate drive loss and quiescent power loss.

The equation below can be used to calculate the power dissipation of the gate driver. QGMF is the total gate charge for each main MOSFET and QGSF is the total gate charge for each synchronous MOSFET.

$$P_{DRV} = \left[\frac{f_{SW}}{2 \times n} \times (n_{MF} \times Q_{GMF} + n_{SF} \times Q_{GSF}) + I_{CC} \right] \times V_{CC} \quad (\text{eq. 1})$$

Also shown is the standby dissipation factor (ICC x VCC) of the driver.

NCP81051

PACKAGE DIMENSIONS

DFN8 2x2
CASE 506AA-01
ISSUE E

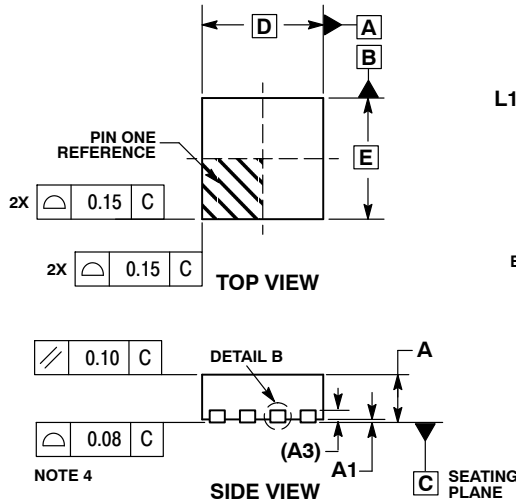

NOTES:

1. DIMENSIONING AND TOLERANCING PER ASME Y14.5M, 1994 .
2. CONTROLLING DIMENSION: MILLIMETERS.
3. DIMENSION b APPLIES TO PLATED TERMINAL AND IS MEASURED BETWEEN 0.15 AND 0.20 MM FROM TERMINAL TIP.
4. COPLANARITY APPLIES TO THE EXPOSED PAD AS WELL AS THE TERMINALS.

DIM	MILLIMETERS	
	MIN	MAX
A	0.80	1.00
A1	0.00	0.05
A3	0.20 REF	
b	0.20	0.30
D	2.00 BSC	
D2	1.10	1.30
E	2.00 BSC	
E2	0.70	0.90
e	0.50 BSC	
K	0.30 REF	
L	0.25	0.35
L1	---	0.10

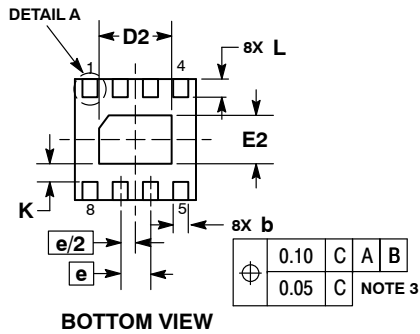

RECOMMENDED SOLDERING FOOTPRINT*

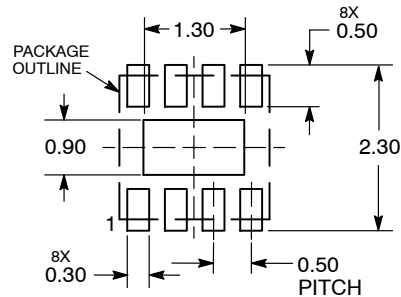

DIMENSIONS: MILLIMETERS

*For additional information on our Pb-Free strategy and soldering details, please download the ON Semiconductor Soldering and Mounting Techniques Reference Manual, SOLDERRM/D.

ON Semiconductor and are registered trademarks of Semiconductor Components Industries, LLC (SCILLC). SCILLC reserves the right to make changes without further notice to any products herein. SCILLC makes no warranty, representation or guarantee regarding the suitability of its products for any particular purpose, nor does SCILLC assume any liability arising out of the application or use of any product or circuit, and specifically disclaims any and all liability, including without limitation special, consequential or incidental damages. "Typical" parameters which may be provided in SCILLC data sheets and/or specifications can and do vary in different applications and actual performance may vary over time. All operating parameters, including "Typicals" must be validated for each customer application by customer's technical experts. SCILLC does not convey any license under its patent rights nor the rights of others. SCILLC products are not designed, intended, or authorized for use as components in systems intended for surgical implant into the body, or other applications intended to support or sustain life, or for any other application in which the failure of the SCILLC product could create a situation where personal injury or death may occur. Should Buyer purchase or use SCILLC products for any such unintended or unauthorized application, Buyer shall indemnify and hold SCILLC and its officers, employees, subsidiaries, affiliates, and distributors harmless against all claims, costs, damages, and expenses, and reasonable attorney fees arising out of, directly or indirectly, any claim of personal injury or death associated with such unintended or unauthorized use, even if such claim alleges that SCILLC was negligent regarding the design or manufacture of the part. SCILLC is an Equal Opportunity/Affirmative Action Employer. This literature is subject to all applicable copyright laws and is not for resale in any manner.

PUBLICATION ORDERING INFORMATION

LITERATURE FULFILLMENT:
Literature Distribution Center for ON Semiconductor
P.O. Box 5163, Denver, Colorado 80217 USA
Phone: 303-675-2175 or 800-344-3860 Toll Free USA/Canada
Fax: 303-675-2176 or 800-344-3867 Toll Free USA/Canada
Email: orderlit@onsemi.com

N. American Technical Support: 800-282-9855 Toll Free
USA/Canada
Europe, Middle East and Africa Technical Support:
Phone: 421 33 790 2910
Japan Customer Focus Center
Phone: 81-3-5773-3850

ON Semiconductor Website: www.onsemi.com
Order Literature: <http://www.onsemi.com/orderlit>
For additional information, please contact your local Sales Representative

AMEYA360

Components Supply Platform

Authorized Distribution Brand :



Website :

Welcome to visit www.ameya360.com

Contact Us :

➤ Address :

401 Building No.5, JiuGe Business Center, Lane 2301, Yishan Rd
Minhang District, Shanghai , China

➤ Sales :

Direct +86 (21) 6401-6692

Email amall@ameya360.com

QQ 800077892

Skype [ameyasales1](#) [ameyasales2](#)

➤ Customer Service :

Email service@ameya360.com

➤ Partnership :

Tel +86 (21) 64016692-8333

Email mkt@ameya360.com