

THIS DRAWING IS UNPUBLISHED.

RELEASED FOR PUBLICATION

12JUN2012

© COPYRIGHT 2012

BY Tyco Electronics Japan G.K.

ALL RIGHTS RESERVED.

LOC J DIST -

REVISIONS

P	LTR	DESCRIPTION	DATE	DWN	APVD
A		RELEASED	06DEC2013	T.S	N.Y
B		ADD ITEM	18NOV2014	T.S	N.Y

- 1. -1 : TYPE I , INSULATION DIAMETER 1.05-1.15mm
- 1- -1 : TYPE II, INSULATION DIAMETER 1.05-1.15mm
- 2 : TYPE I , INSULATION DIAMETER 0.93-1.05mm
- 1- -2 : TYPE II, INSULATION DIAMETER 0.93-1.05mm
- 3 : TYPE I , INSULATION DIAMETER 0.93-1.05mm IPC, 1.05-1.15mm IPC
- 4 : TYPE I , INSULATION DIAMETER 1.1-1.2mm

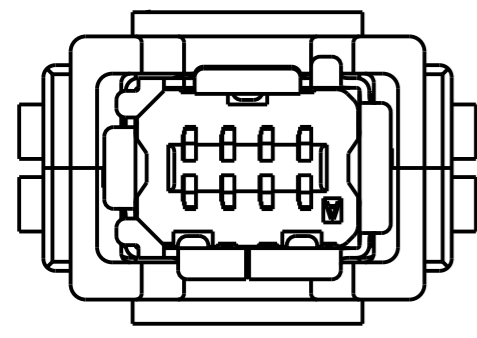
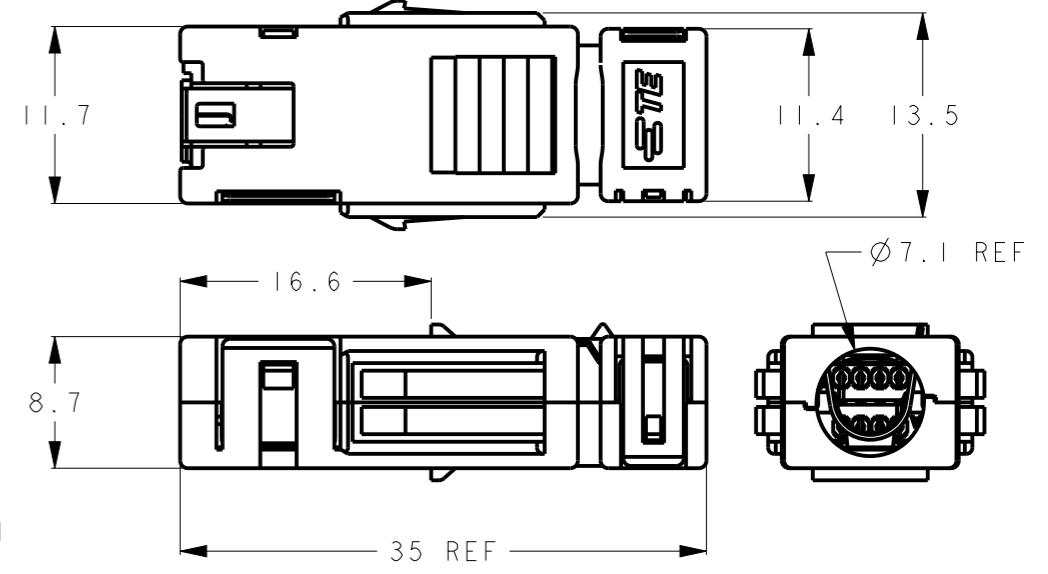
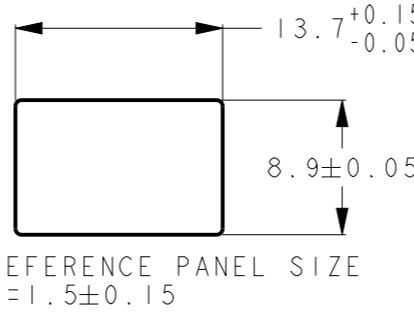

MATING SHAPE : TYPE I
2201864-1/-2-3
SCALE 4:1

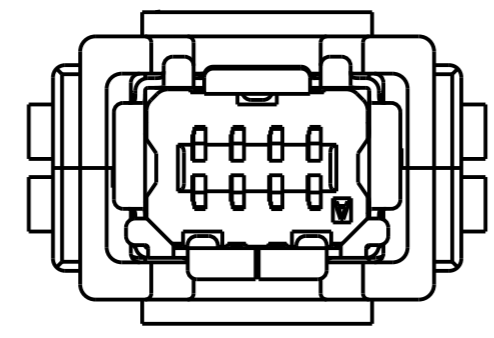

MATING SHAPE : TYPE II
1-2201864-1/-2
SCALE 4:1

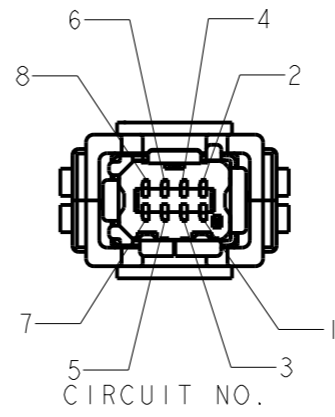

CIRCUIT NO.

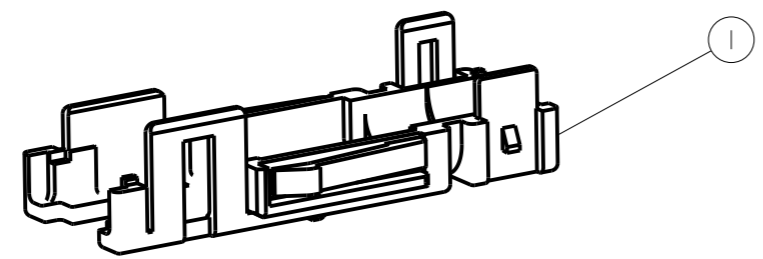
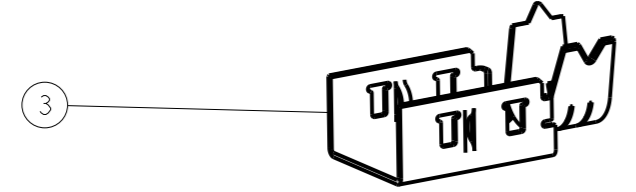
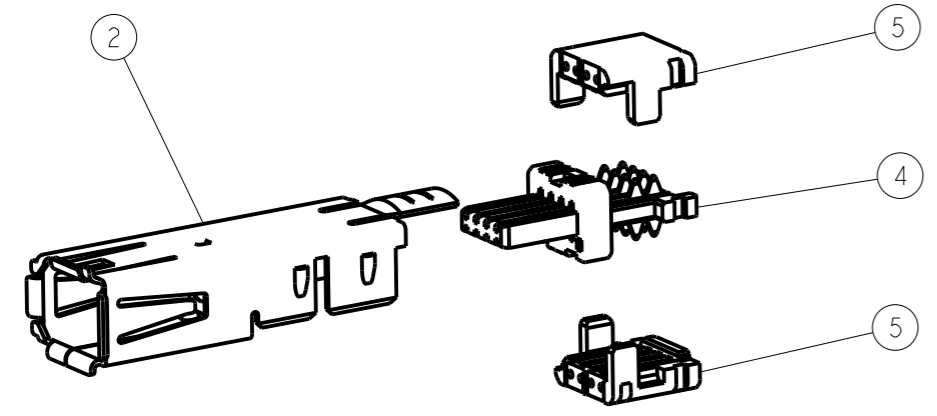
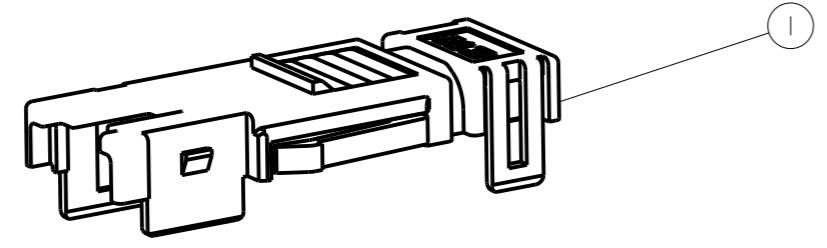

2	-	-	-	-	-				
-	1	2	2	-	-	THERMO PLASTIC	CABLE HSG Ø1.1-1.2 COLOR : GREEN		
-	1	-	-	2	2		CABLE HSG Ø0.93-1.05 COLOR : RED	5	
							CABLE HSG Ø1.05-1.15 COLOR : BLUE		
1	1	1	1	1	1	HSG MATERIAL:THERMO PLASTIC			
						CONTACT MATERIAL:COPPER ALLOY FINISH:NI PLATING ALL OVER CONTACT AREA Au PLATING TERMINATION AREA Au PLATING	REC SUB ASSY	4	
1	1	1	1	1	1	MATERIAL:COPPER ALLOY FINISH:NICKEL PLATING	BOTTOM SHELL	3	
-	-	1	-	1	-	MATERIAL:COPPER ALLOY FINISH:NICKEL PLATING	REC TOP SHELL TYPE II		
1	1	-	1	-	1	MATERIAL:COPPER ALLOY FINISH:NICKEL PLATING	REC TOP SHELL TYPE I	2	
2	2	2	2	2	2	THERMO PLASTIC	REC COVER HSG	1	
-4	-3	1-	-2	-2	1-	-1	MATERIAL/FINISH	PART NAME	ITEM

THIS DRAWING IS A CONTROLLED DOCUMENT.

DWN 06DEC2013 T.SHIMOYASU
CHK 06DEC2013 M.HARASAWA
APVD 06DEC2013 N.YAMASAKI

STE TE Connectivity

NAME INDUSTRIAL MINI I/O PIERCING REC CONNECTOR KIT

PRODUCT SPEC 108-78955
APPLICATION SPEC 114-5506
WEIGHT -

SIZE A3 CAGE CODE 00779 DRAWING NO C-2201864 RESTRICTED TO -

CUSTOMER DRAWING SCALE 2:1 SHEET 1 OF 1 REV B

Authorized Distribution Brand :



Website :

Welcome to visit www.ameya360.com

Contact Us :

➤ Address :

401 Building No.5, JiuGe Business Center, Lane 2301, Yishan Rd
Minhang District, Shanghai , China

➤ Sales :

Direct +86 (21) 6401-6692

Email amall@ameya360.com

QQ 800077892

Skype ameyasales1 ameyasales2

➤ Customer Service :

Email service@ameya360.com

➤ Partnership :

Tel +86 (21) 64016692-8333

Email mkt@ameya360.com