

## 12-W, 3.3/5-V INPUT, WIDE OUTPUT ADJUSTABLE BOOST CONVERTER

Check for Samples: [PTN04050C](#)

### FEATURES

- Up to 12 W Output Power
- Wide Input Voltage Range (2.95 V to 5.5 V)
- Wide Output Voltage Adjust (5 V to 15 V)
- High Efficiency (Up to 90%)
- Operating Temperature:  $-40^{\circ}\text{C}$  to  $85^{\circ}\text{C}$
- Surface Mount Package Available

### APPLICATIONS

- Telecommunications, Instrumentation, and General-Purpose Applications

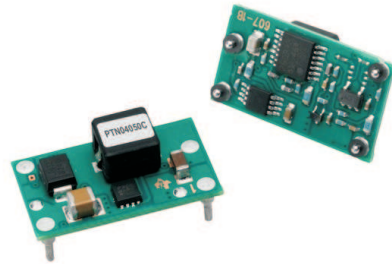

### DESCRIPTION

The PTN04050C is a 4-pin boost-voltage regulator product. In new designs it should be considered in place of the PT5040 series of positive step-up products. The PTN04050C is smaller and lighter than its predecessors, and has either similar or improved electrical performance characteristics. The case-less, double-sided package, also exhibits improved thermal characteristics, and is compatible with TI's roadmap for RoHS and lead-free compliance.

Operating over a 2.95V to 5.5V input range, the PTN04050C provides high-efficiency, step-up voltage conversion for loads of up to 12W. The output voltage is set using a single external resistor. The PTN04050C may be set to any value within the range, 5V to 15V. The output voltage of the PTN04050C can be as little as 0.5V higher than the input, allowing an output voltage of 5V, with an input voltage of 4.5V.

The PTN04050C modules are suited to a wide variety of general-purpose applications that operate off 3.3-V or 5-V dc power.

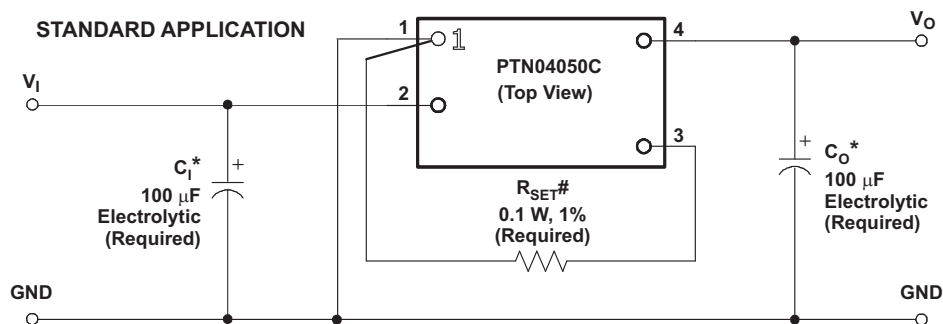

\* See the *Application Information* section for capacitor recommendations.

# See the *Application Information* section for  $R_{\text{SET}}$  values.



Please be aware that an important notice concerning availability, standard warranty, and use in critical applications of Texas Instruments semiconductor products and disclaimers thereto appears at the end of this data sheet.



These devices have limited built-in ESD protection. The leads should be shorted together or the device placed in conductive foam during storage or handling to prevent electrostatic damage to the MOS gates.

### ORDERING INFORMATION

For the most current package and ordering information, see the Package Option Addendum at the end of this datasheet, or see the TI website at [www.ti.com](http://www.ti.com).

### ABSOLUTE MAXIMUM RATINGS <sup>(1)</sup>

over operating free-air temperature range unless otherwise noted  
all voltages with respect to GND (pin 1),

			UNIT
$T_A$	Operating free-air temperature	Over $V_I$ range	–40°C to 85°C
	Leaded temperature (H suffix)	5 seconds	260°C <sup>(2)</sup>
	Solder reflow temperature (S suffix)	Surface temperature of module body or pins	235°C
	Solder reflow temperature (Z suffix) <sup>(3)</sup>	Surface temperature of module body or pins	260°C <sup>(3)</sup>
$T_{stg}$	Storage temperature		–55°C to 125°C
$P_O$	Output power		12 W

- (1) Stresses beyond those listed under absolute maximum ratings may cause permanent damage to the device. These are stress ratings only, and functional operation of the device at these or any other conditions beyond those indicated under recommended operating conditions is not implied. Exposure to absolute-maximum-rated conditions for extended periods may affect device reliability.
- (2) This model is NOT compatible with surface-mount reflow solder process.
- (3) Moisture Sensitivity Level (MSL) Rating Level-3-260C-168HR

### RECOMMENDED OPERATING CONDITIONS

		MIN	MAX	UNIT
$V_I$	Input voltage	2.95	5.5	V
$T_A$	Operating free-air temperature	–40	85	°C

### PACKAGE SPECIFICATIONS

PTN04050Cx (Suffix AH, AS, and AZ)			
Weight			2.8 grams
Flammability	Meets UL 94 V-O		
Mechanical shock	Per Mil-STD-883D, Method 2002.3, 1 ms, 1/2 sine, mounted		500 G <sup>(1)</sup>
Mechanical vibration	Mil-STD-883D, Method 2007.2, 20-2000 Hz	Horizontal T/H (suffix AH)	20 G <sup>(1)</sup>
		Horizontal SMD (suffix AS and AZ)	15 G <sup>(1)</sup>

- (1) Qualification limit.

## ELECTRICAL CHARACTERISTICS

 operating at 25°C free-air temperature,  $V_I = 5\text{ V}$ ,  $V_O = 12\text{ V}$ ,  $I_O = I_O(\text{max})$ ,  $C_I = 100\text{ }\mu\text{F}$ ,  $C_O = 100\text{ }\mu\text{F}$  (unless otherwise noted)

PARAMETER		TEST CONDITIONS	PTN04050C				
			MIN	TYP	MAX	UNIT	
$I_O$	Output current	Over $V_I$ Range $V_O = 15\text{ V}$ $V_O = 12\text{ V}$ $V_O = 9\text{ V}$ $V_O = 5\text{ V}$	0.1 <sup>(1)</sup>		0.8	A	
			0.1 <sup>(1)</sup>		1.0		
			0.1 <sup>(1)</sup>		1.3		
			0.1 <sup>(1)</sup>		2.4		
$V_I$	Input voltage range	Over $I_O$ range	2.95		5.5 <sup>(2)</sup>	V	
$V_O$	Output adjust range		5		15	V	
	Set-point voltage tolerance	$T_A = 25^\circ\text{C}$			$\pm 2$ <sup>(3)</sup>	% $V_O$	
	Temperature variation	$-40^\circ\text{C}$ to $85^\circ\text{C}$			$\pm 0.5$	% $V_O$	
	Line regulation	Over $V_I$ range			$\pm 0.5$	% $V_O$	
	Load regulation	Over $I_O$ range			$\pm 0.5$	% $V_O$	
	Total Output Voltage Variation	Includes set point, line, load $-40^\circ\text{C} < T_A < 85^\circ\text{C}$			$\pm 3$ <sup>(3)</sup>	% $V_O$	
$\eta$	Efficiency	$V_I = 5\text{ V}$ , $R_{\text{SET}} = 60.4\text{ }\Omega$ , $V_O = 15\text{ V}$			88%		
		$V_I = 5\text{ V}$ , $R_{\text{SET}} = 1.33\text{ k}\Omega$ , $V_O = 12\text{ V}$			89%		
		$V_I = 5\text{ V}$ , $R_{\text{SET}} = 4.53\text{ k}\Omega$ , $V_O = 9\text{ V}$			90%		
		$V_I = 3.3\text{ V}$ , $R_{\text{SET}} = \text{OPEN}$ , $V_O = 5\text{ V}$			87%		
	Output voltage ripple (peak-to-peak)	20-MHz bandwidth			1.5	3	% $V_O$
	Transient response	1 A/ $\mu\text{s}$ load step from 50% to 100% $I_{O\text{max}}$					
		Recovery time			500		$\mu\text{s}$
		$V_O$ over/undershoot			2.5		% $V_O$
$I_{\text{lim}}$	Current limit				150 <sup>(4)</sup>		% $I_{O\text{max}}$
$I_{\text{ir}}$	Inrush current				2 <sup>(5)</sup>		A
$t_{\text{ir}}$	Inrush current time duration				1		ms
$F_S$	Switching frequency	Over $V_I$ and $I_O$ ranges	450	525	600		kHz
$C_I$	External input capacitance		100 <sup>(6)</sup>				$\mu\text{F}$
$C_O$	External output capacitance	Nonceramic	100 <sup>(7)</sup>		560 <sup>(8)</sup>		$\mu\text{F}$
		Ceramic	0		100 <sup>(9)</sup>		
		Equivalent series resistance (nonceramic)	10 <sup>(10)</sup>				m $\Omega$
MTBF	Calculated reliability	Per Telcordia SR-332, 50% stress, $T_A = 40^\circ\text{C}$ , ground benign	8.9				$10^6\text{ Hr}$

- (1) Operation at no load is not recommended.
- (2) The maximum  $V_I$  is 5.5V or ( $V_O - 0.5\text{V}$ ) whichever is less. If the difference in  $V_O$  to  $V_{\text{IN}}$  is  $\geq 0.5\text{V}$  and  $\leq 1.4\text{V}$ , the device will operate in asynchronous mode. In this condition, there may be multiple output voltage ripple frequencies and the total output voltage variation may increase by up to 2%.
- (3) The set-point voltage tolerance is affected by the tolerance and stability of  $R_{\text{SET}}$ . The stated limit is unconditionally met if  $R_{\text{SET}}$  has a tolerance of 1% with 100 ppm/ $^\circ\text{C}$  or better temperature stability.
- (4) Boost-topology switching regulators are not short-circuit protected.
- (5) The inrush current stated is in addition to the normal input current for the associated output load.
- (6) An external input capacitor is required across the input ( $V_I$  and GND) for proper operation. See the application information for further guidance.
- (7) An external output capacitance is required for proper operation. See the application information for further guidance.
- (8) The minimum ESR limitation may result in a lower value for the output capacitance. See the application information for further guidance.
- (9) When using ceramic capacitors equivalent to 100  $\mu\text{F}$ , a 100  $\mu\text{F}$  bulk electrolytic is also required.
- (10) This is the minimum ESR for all the electrolytic (nonceramic) output capacitance. Use 17 m $\Omega$  as the minimum when using maximum ESR values to calculate.

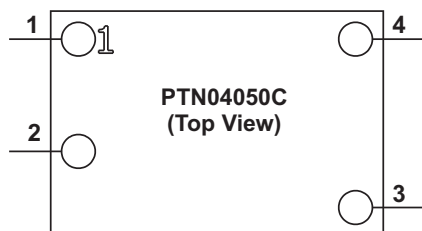
**PIN ASSIGNMENT****PIN FUNCTIONS**

PIN		I/O	DESCRIPTION
NAME	NO.		
GND	1	I/O	This is the common ground connection for the $V_I$ and $V_O$ power connections. It is also the $0 V_{dc}$ reference for the $V_O$ Adjust control input.
$V_I$	2	I	The positive input voltage power node to the module, which is referenced to common GND.
$V_O$ Adjust	3	I	A 1% resistor must be connected between this pin and GND (pin 1) to set the output voltage. If left open-circuit, the output voltage will default to its minimum adjust value. The temperature stability of the resistor should be 100 ppm/°C (or better). The set-point range is 5 V to 15 V. The standard resistor value for a number of common output voltages is provided in the application information.
$V_O$	4	O	The regulated positive power output with respect to the GND node.

TYPICAL CHARACTERISTICS (3.3-V INPUT)<sup>(1) (2)</sup>

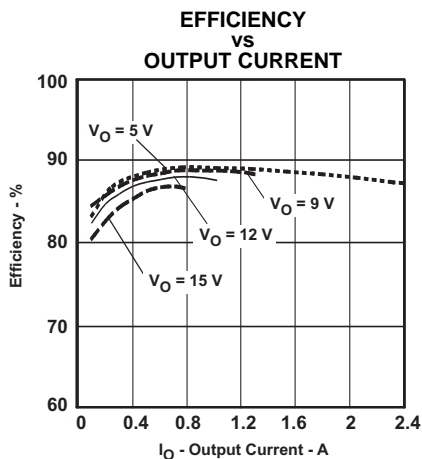

Figure 1.

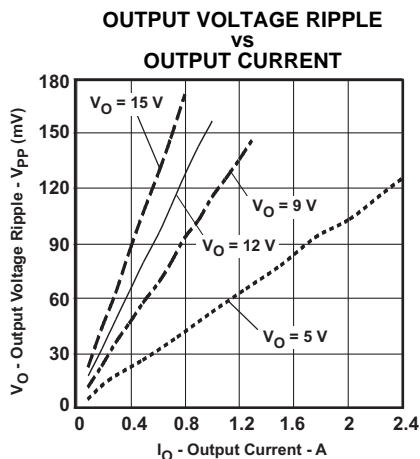

Figure 2.

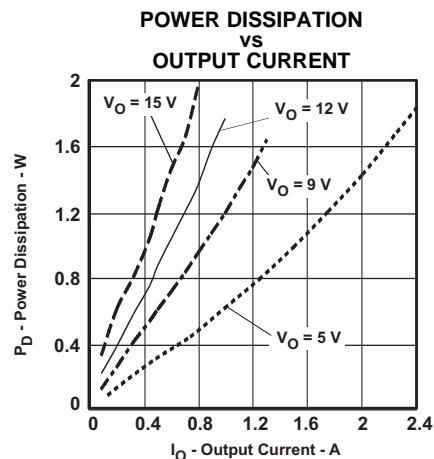

Figure 3.

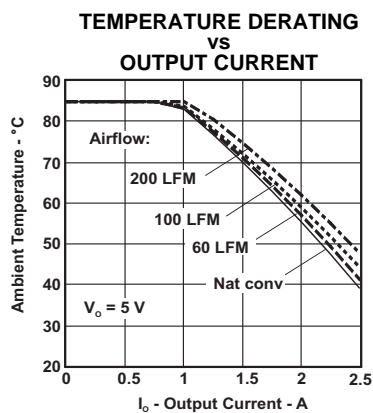

Figure 4.

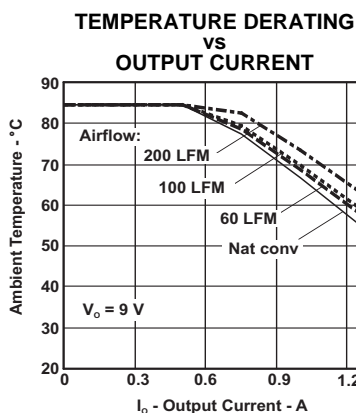

Figure 5.

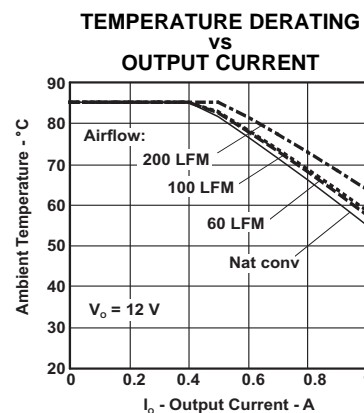

Figure 6.

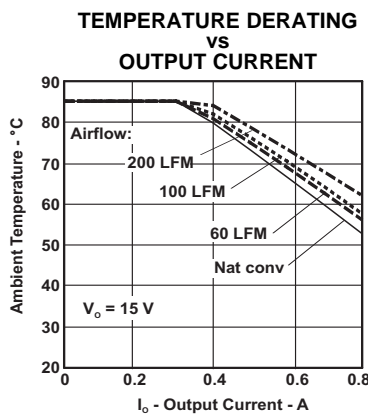

Figure 7.

- (1) The electrical characteristic data has been developed from actual products tested at 25°C. This data is considered typical for the converter. Applies to [Figure 1](#), [Figure 2](#), and [Figure 3](#).
- (2) The Safe Operating Area curves represent the conditions at which internal components are at or below the manufacturer's maximum operating temperatures. Derating limits apply to modules soldered directly to a 100 mm x 100 mm double-sided PCB with 2 oz. copper. Applies to [Figure 4](#), [Figure 5](#), [Figure 6](#), and [Figure 7](#).

TYPICAL CHARACTERISTICS (5-V INPUT)<sup>(1) (2)</sup>

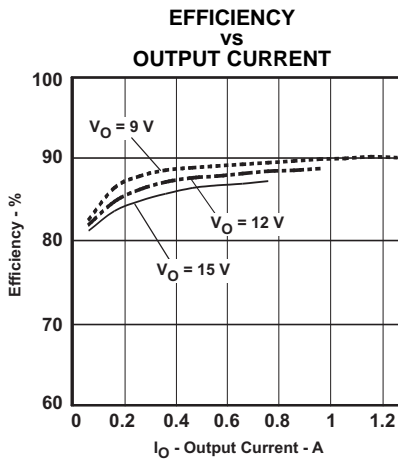

Figure 8.

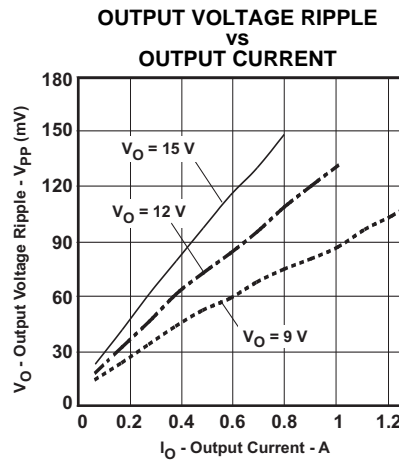

Figure 9.

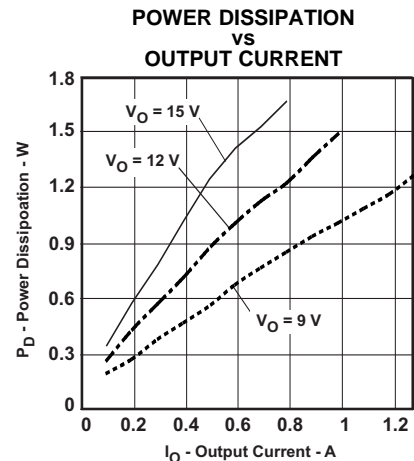

Figure 10.

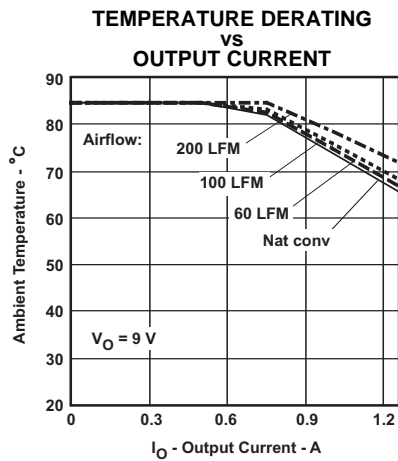

Figure 11.

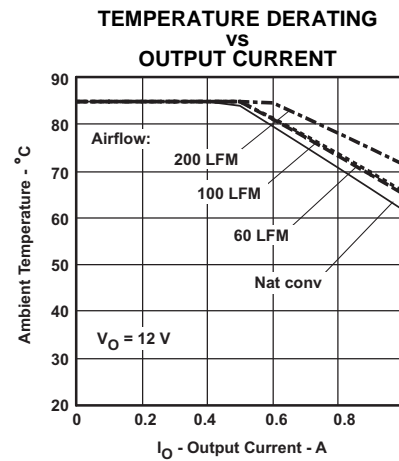

Figure 12.

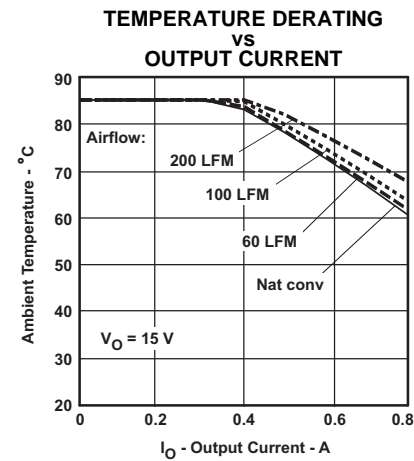

Figure 13.

- (1) The electrical characteristic data has been developed from actual products tested at 25°C. This data is considered typical for the converter. Applies to [Figure 8](#), [Figure 9](#), and [Figure 10](#).
- (2) The Safe Operating Area curves represent the conditions at which internal components are at or below the manufacturer's maximum operating temperatures. Derating limits apply to modules soldered directly to a 100-mm x 100-mm, double-sided PCB with 2 oz. copper. Applies to [Figure 11](#), [Figure 12](#), and [Figure 13](#).

## APPLICATION INFORMATION

### Adjusting the Output Voltage of the PTN04050C Wide-Output Adjust Power Modules

#### General

A resistor must be connected between the  $V_O$  Adjust control (pin 3) and GND (pin 1) to set the output voltage of the PTN04050C product. The adjustment range is from 5 V to 15 V. If pin 3 is left open, the output voltage defaults to the lowest value.

Table 1 gives the standard resistor value for several common voltages, along with the actual output voltage that the value provides. For other output voltages, the value of the required resistor can be calculated using Equation 1. Alternatively,  $R_{SET}$  can be simply selected from the range of values given in Table 2. Figure 14 shows the placement of the required resistor.

$$R_{SET} = 15 \text{ k}\Omega \times \frac{2 \text{ V}}{V_O - 5 \text{ V}} - 2.94 \text{ k}\Omega \quad (1)$$

**Table 1. Standard Values of  $R_{SET}$  for Common Output Voltages**

$V_O$ (Required)	$R_{SET}$ (Standard Value)	$V_O$ (Actual)
5.0 V	Open	5.00 V
9.0 V	4.53 k $\Omega$	9.01 V
12.0 V	1.33 k $\Omega$	12.03 V
15.0 V	60.4 $\Omega$	14.99 V

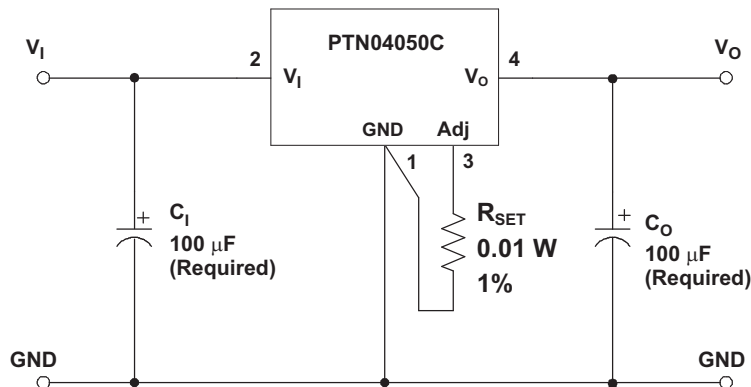

- (1) A 0.05-W rated resistor may be used. The tolerance should be 1%, with a temperature stability of 100 ppm/ $^{\circ}$ C (or better). Place the resistor as close to the regulator as possible. Connect the resistor directly between pins 3 and 1 using dedicated PCB traces.
- (2) Never connect capacitors from  $V_O$  Adjust to GND or  $V_O$ . Any capacitance added to the  $V_O$  Adjust pin affects the stability of the regulator.

**Figure 14. PTN04050C  $V_O$  Adjust Resistor Placement**

**Table 2. PTN04050C Output Voltage Set-Point Resistor Values**

$V_O$	$R_{SET}$	$V_O$	$R_{SET}$	$V_O$	$R_{SET}$
5 V	Open	10 V	3.06 k $\Omega$	12.6 V	1.01 k $\Omega$
5.2 V	147 k $\Omega$	10.1 V	2.94 k $\Omega$	12.7 V	956 $\Omega$
5.4 V	72 k $\Omega$	10.2 V	2.83 k $\Omega$	12.8 V	906 $\Omega$
5.6 V	47 k $\Omega$	10.3 V	2.72 k $\Omega$	12.9 V	857 $\Omega$
5.8 V	34.5 k $\Omega$	10.4 V	2.62 k $\Omega$	13 V	810 $\Omega$
6 V	27 k $\Omega$	10.5 V	2.52 k $\Omega$	13.1 V	764 $\Omega$
6.2 V	22 k $\Omega$	10.6 V	2.42 k $\Omega$	13.2 V	719 $\Omega$
6.4 V	18.5 k $\Omega$	10.7 V	2.32 k $\Omega$	13.3 V	674 $\Omega$
6.6 V	15.8 k $\Omega$	10.8 V	2.23 k $\Omega$	13.4 V	631 $\Omega$
6.8 V	13.7 k $\Omega$	10.9 V	2.15 k $\Omega$	13.5 V	589 $\Omega$
7 V	12 k $\Omega$	11 V	2.06 k $\Omega$	13.6 V	548 $\Omega$
7.2 V	10.7 k $\Omega$	11.1 V	1.98 k $\Omega$	13.7 V	508 $\Omega$
7.4 V	9.56 k $\Omega$	11.2 V	1.89 k $\Omega$	13.8 V	469 $\Omega$
7.6 V	8.60 k $\Omega$	11.3 V	1.82 k $\Omega$	13.9 V	431 $\Omega$
7.8 V	7.77 k $\Omega$	11.4 V	1.75 k $\Omega$	14 V	393 $\Omega$
8 V	7.06 k $\Omega$	11.5 V	1.67 k $\Omega$	14.1 V	357 $\Omega$
8.2 V	6.44 k $\Omega$	11.6 V	1.60 k $\Omega$	14.2 V	321 $\Omega$
8.4 V	5.88 k $\Omega$	11.7 V	1.54 k $\Omega$	14.3 V	286 $\Omega$
8.6 V	5.39 k $\Omega$	11.8 V	1.47 k $\Omega$	14.4 V	251 $\Omega$
8.8 V	4.95 k $\Omega$	11.9 V	1.41 k $\Omega$	14.5 V	218 $\Omega$
9 V	4.56 k $\Omega$	12 V	1.35 k $\Omega$	14.6 V	185 $\Omega$
9.2 V	4.20 k $\Omega$	12.1 V	1.29 k $\Omega$	14.7 V	153 $\Omega$
9.4 V	3.88 k $\Omega$	12.2 V	1.23 k $\Omega$	14.8 V	121 $\Omega$
9.6 V	3.58 k $\Omega$	12.3 V	1.17 k $\Omega$	14.9 V	90 $\Omega$
9.8 V	3.31 k $\Omega$	12.4 V	1.11 k $\Omega$	15 V	60 $\Omega$
9.9 V	3.18 k $\Omega$	12.5 V	1.06 k $\Omega$		



## CAPACITOR RECOMMENDATIONS FOR PTN04050C WIDE-OUTPUT ADJUST POWER MODULES

### Input Capacitor

The minimum required input capacitance is 100  $\mu\text{F}$ . The minimum ripple current rating for any nonceramic capacitance must be greater than 250 mA rms. The ripple current rating of electrolytic capacitors is a major consideration when they are used at the input. This ripple current requirement can be reduced by placing ceramic capacitors at the input, in addition to the minimum required capacitance.

When specifying regular tantalum capacitors for use at the input, a minimum voltage rating of 2 X (maximum dc voltage + ac ripple) is highly recommended. This is standard practice to ensure reliability. Polymer-tantalum capacitors are not affected by this requirement. (Please verify voltage derating for the polymer-tantalum capacitors from the vendors.)

### Output Capacitor

The minimum capacitance required to insure stability is a 100  $\mu\text{F}$ . A combination of both ceramic and electrolytic-type capacitors should be used. The minimum ripple current rating for the nonceramic capacitance must be at least 150 mA rms. When using ceramic capacitors equivalent to 100  $\mu\text{F}$ , a 100  $\mu\text{F}$  bulk electrolytic is also required. The stability of the module and voltage tolerances are compromised if the capacitor is not placed near the output pin. A high-quality, computer-grade electrolytic capacitor is adequate. Ceramic capacitance should also be located within 0.5 inches (1,27 cm) of the output pin.

For applications with load transients (sudden changes in load current), the regulator response improves with additional capacitance. Additional electrolytic capacitors should be located close to the load circuit. These capacitors provide decoupling over the frequency range, 2 kHz to 150 kHz. Aluminum electrolytic capacitors are suitable for ambient temperatures above 0°C. For operation below 0°C, tantalum or OS-CON type capacitors are recommended. When using one or more nonceramic capacitors, the calculated equivalent ESR should be no lower than 10 m $\Omega$  (17 m $\Omega$  using the manufacturer's maximum ESR for a single capacitor). A list of capacitors and vendors are identified in [Table 3](#), the recommended capacitor table.

### Ceramic Capacitors

Above 150 kHz the performance of aluminum electrolytic capacitors becomes less effective. To further reduce the reflected input ripple current, or the output transient response, multilayer ceramic capacitors must be added. Ceramic capacitors have low ESR and their resonant frequency is higher than the bandwidth of the regulator. When placed at the output, their combined ESR is not critical as long as the total value of ceramic capacitance does not exceed 100  $\mu\text{F}$ .

*Note: If only ceramics are used on the output bus, then a 100  $\mu\text{F}$  electrolytic is required for stabilization.*

### Tantalum Capacitors

Tantalum type capacitors may be used at the output, and are recommended for applications where the ambient operating temperature can be less than 0°C. The AVX TPS, Sprague 593D/594/595, and Kemet T495/T510/T520 capacitors series are suggested over many other tantalum types due to their rated surge, power dissipation, and ripple current capability. As a caution, many general-purpose tantalum capacitors have considerably higher ESR, reduced power dissipation, and lower ripple current capability. These capacitors are also less reliable as they have lower power dissipation and surge current ratings. Tantalum capacitors that do not have a stated ESR or surge current rating are not recommended for power applications. When specifying OS-CON and polymer tantalum capacitors for the output, the minimum ESR limit is encountered well before the maximum capacitance value is reached.

### Capacitor Table

The capacitor table, [Table 3](#), identifies the characteristics of capacitors from various vendors with acceptable ESR and ripple current (rms) ratings. The recommended number of capacitors required at both the input and output buses is identified for each capacitor type. This is not an extensive capacitor list. Capacitors from other vendors are available with comparable specifications. Those listed are for guidance. The rms current rating and ESR (at 100 kHz) are critical parameters necessary to insure both optimum regulator performance and long capacitor life.

## Designing for Load Transients

The transient response of the dc/dc converter has been characterized using a load transient with a di/dt of 1 A/ $\mu$ s. The typical voltage deviation for this load transient is given in the data sheet specification table using the required value of output capacitance. As the di/dt of a transient is increased, the response of a converter's regulation circuit ultimately depends on its output capacitor decoupling network. This is an inherent limitation of any dc/dc converter once the speed of the transient exceeds its bandwidth capability. If the target application specifies a higher di/dt or lower voltage deviation, the requirement can only be met with additional output capacitor decoupling. In these cases, special attention must be paid to the type, value, and ESR of the capacitors selected.

If the transient performance requirements exceed those specified in the data sheet, the selection of output capacitors becomes more important. Obey the minimum ESR and maximum capacitance limits specified in the Electrical Characteristics table.

**Table 3. Recommended Input/Output Capacitors <sup>(1)</sup>**

CAPACITOR VENDOR/ COMPONENT SERIES	CAPACITOR CHARACTERISTICS					QUANTITY		VENDOR NUMBER
	WORKING VOLTAGE (V)	VALUE ( $\mu$ F)	EQUIVALENT SERIES RESISTANCE (ESR) ( $\Omega$ )	85°C MAXIMUM RIPPLE CURRENT ( $I_{rms}$ ) (mA)	PHYSICAL SIZE (mm)	INPUT BUS	OUTPUT BUS	
Panasonic FC( Radial)	25	180	0.117	555	8 X 11	1	1	EEUFC1E181
Panasonic FC (SMD)	25	100	0.30	450	8 X 10,2	1	1	EEVFC1E101P
United Chemi-Con PXA (SMD)	16	150	0.026	3430	10 X 7,7	1	1	PXA16VC151MJ80TP ( $V_O \leq 13V$ )
PS	25	100	0.020	4320	10 X 12,5	1	1	25PS100MJ12
LXZ	25	100	0.250	290	6,3 X 11,5	1	1	LXZ25VB101M6X11LL
MVY(SMD)	35	100	0.300	450	8 X 10	1	1	MVY35VC101MH10TP
Nichicon UWG (SMD)	50	100	0.300	500	10 X 10	1	1	UWG1H101MNR1GS
F559 (Tantalum)	10	100	0.055	2000	7,7 X 4,3	1	1 <sup>(2)</sup>	F551A107MN ( $V_O \leq 5V$ )
HD	25	100	0.130	405	6,3 X 11	1	1	UHD1E101MER
Sanyo OS-CON SVP (SMD)	20	100	0.024	2500	8 X 12	1	1	20SVP100M
SP	16	100	0.032	2890	10 X 5	1	1 <sup>(2)</sup>	16SP100M ( $V_O \leq 14V$ )
AVX Tantalum TPS (SMD)	20	100	0.085	1543	7,3X 6,1X 3.5	1	1 <sup>(2)</sup>	TPSV107M020R0085 ( $V_O \leq 10 V$ )
	20	100	0.200	> 817	7,3X 6,1X 3.5	1	1 <sup>(2)</sup>	TPSV107M020R0200 ( $V_O \leq 10 V$ )
Murata X5R Ceramic	6.3	100	0.002	>1000	3225	1	1 <sup>(2)</sup>	GRM32ER60J107M ( $V_O \leq 5.5 V$ )
TDK X5R Ceramic	6.3	100	0.002	>1000	3225	1	1 <sup>(2)</sup>	C3225X5R0J107MT ( $V_O \leq 5.5 V$ )
Murata X5R Ceramic	16	47	0.002	>1000	3225	2	$\leq 2$ <sup>(2)</sup>	GRM32ER61C476M
Kemet X5R Ceramic	6.3	47	0.002	>1000	3225	2	$\leq 2$ <sup>(2)</sup>	C1210C476K9PAC ( $V_O \leq 5.5 V$ )
TDK X5R Ceramic	6.3	47	0.002	>1000	3225	2	$\leq 2$ <sup>(2)</sup>	C3225X5R0J476MT ( $V_O \leq 5.5 V$ )
Murata X5R Ceramic	6.3	47	0.002	>1000	3225	2	$\leq 2$ <sup>(2)</sup>	GRM422X5R476M6.3 ( $V_O \leq 5.5 V$ )
TDK X5R Ceramic	16	22	0.002	>1000	3225	5	$\leq 5$ <sup>(2)</sup>	C3225X5R1E2265KT/MT
Murata X7R Ceramic	25	22	0.002	>1000	3225	5	$\leq 5$	GRM32ER61C226K
Kemet X7R Ceramic	16	22	0.002	>1000	3225	5	$\leq 5$ <sup>(2)</sup>	C1210C226K3PAC

### (1) Capacitor Supplier Verification

1. Verify availability of capacitors identified in this table. Capacitor suppliers may recommend alternative part numbers because of limited availability or obsolete products. In some instances, the capacitor product life cycle may be in decline and have short-term consideration for obsolescence.

#### RoHS, Lead-free and Material Details

2. Consult capacitor suppliers regarding material composition, RoHS status, lead-free status, and manufacturing process requirements. Component designators or part number deviations may occur if material composition or soldering requirements change.

(2) The maximum voltage rating of the capacitor must be selected for the desired set-point voltage ( $V_O$ ). To operate at a higher output voltage, select a capacitor with a higher voltage rating.

## Power-Up Characteristics

When configured per the standard application, the PTN04050C power module produces a regulated output voltage following the application of a valid input source voltage. During power up, internal soft-start circuitry slows the rate that the output voltage rises, thereby limiting the amount of in-rush current drawn from the input source. Figure 15 shows the power-up waveforms for a PTN04050C, operating from a 5-V input and with the output voltage adjusted to 12 V. The waveforms were measured with a 1-A resistive load.

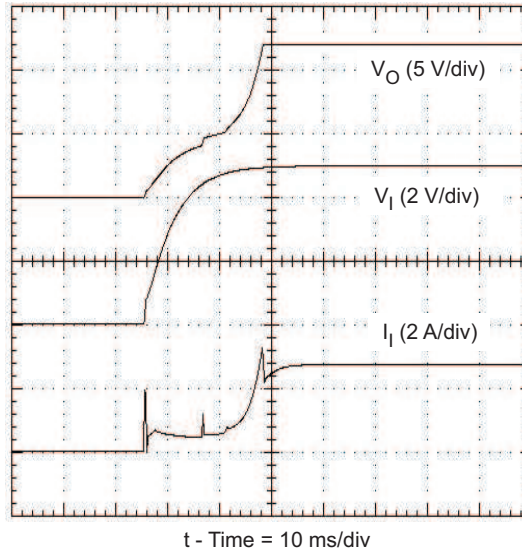

**Figure 15. Power-Up Waveforms**

## Overtemperature Protection

A thermal shutdown mechanism protects the module's internal circuitry against excessively high temperatures. A rise in temperature may be the result of a drop in airflow, a high ambient temperature, or a sustained overcurrent condition. If the junction temperature of the internal control IC rises excessively, the module turns its boost operation off. Although the module is off, an output voltage of approximately ( $V_I - 300$  mV) is still present. The module restarts boost operation when the sensed temperature decreases by approximately 10 degrees.

**Note:** *Overtemperature protection is a last resort mechanism to prevent damage to the module. It should not be relied on as permanent protection against thermal stress. Always operate the module within its temperature derated limits, for the worst-case operating conditions of output current, ambient temperature, and airflow. Operating the module above these limits, albeit below the thermal shutdown temperature, reduces the long-term reliability of the module.*

## Boost Topology

With boost regulators an output voltage of approximately ( $V_I - 300\text{ mV}$ ) is present whenever the input voltage to the module is below the minimum input voltage range, or during an overtemperature condition. Also, a boost regulator cannot provide inherent short-circuit protection. This is due to the fact that there is a dc path from the input to the output even when the PWM and FET are not operating. This is shown in the boost topology diagram in Figure 16.

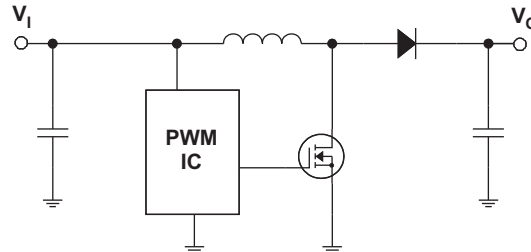

Figure 16. Typical Boost Converter Topology

## Optional Input/Output Filters

Power modules include internal input and output ceramic capacitors in all their designs. However, some applications require much lower levels of either input reflected or output ripple/noise. This section describes various filters and design techniques found to be successful in reducing both input and output ripple/noise.

### Input/Output Capacitors

A first step toward reducing output ripple and noise is to add one or more 22- $\mu\text{F}$  ceramic capacitors, such as C4 shown in Figure 17. Ceramic capacitors should be placed close to the output power terminals. A single 22- $\mu\text{F}$  capacitor reduces the output ripple/noise by 10% to 30% for modules with a rated output current of less than 3 A. (Note: C3 is recommended to improve the regulators transient response and does not reduce output ripple and noise.)

Switching regulators draw current from the input line in pulses at their operating frequency. The amount of reflected (input) ripple/noise generated is directly proportional to the equivalent source impedance of the power source including the impedance of any input lines. The addition of C1, minimum 22- $\mu\text{F}$  ceramic capacitor, near the input power pins, reduces reflected conducted ripple/noise by 30% to 50%.

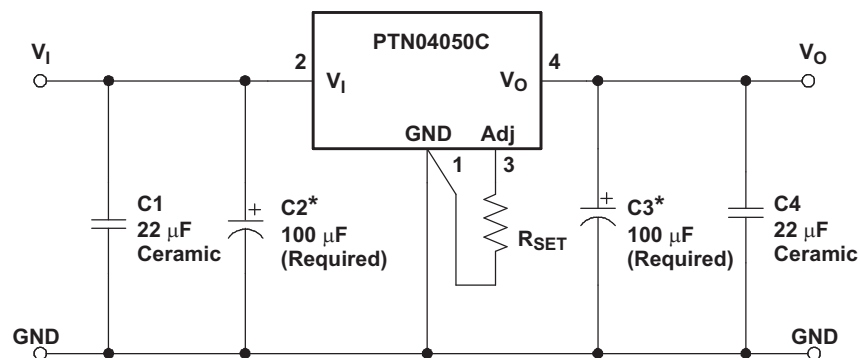

\* See the *Application Information* section for suggested value and type.

Figure 17. Adding High-Frequency Bypass Capacitors To The Input and Output

**π Filters**

If a further reduction in ripple/noise level is required for an application, higher order filters must be used. A π (pi) filter, employing a ferrite bead (Fair-Rite Part Number 2673000701 or equivalent) in series with the input or output terminals of the regulator reduces the ripple/noise by at least 20 db (see Figure 18 and Figure 19). In order for the inductor to be effective in reduction of ripple and noise, ceramic capacitors are required. (Note: for additional information on vendors and component suggestions, see the capacitor recommendations for the PTN04050C.)

These inductors plus ceramic capacitors form an excellent filter because of the rejection at the switching frequency (650 kHz - 1 MHz). The placement of this filter is critical. It must be located as close as possible to the input or output pins to be effective. The ferrite bead is small (12,5 mm X 3 mm) and has low dc resistance. Fair-Rite also manufactures a surface-mount bead (Part No. 2773021447), through hole (Part Number 2673000701) rated to 5 A. Inductors in the range of 1 μH to 5 μH can be used in place of the ferrite inductor bead.

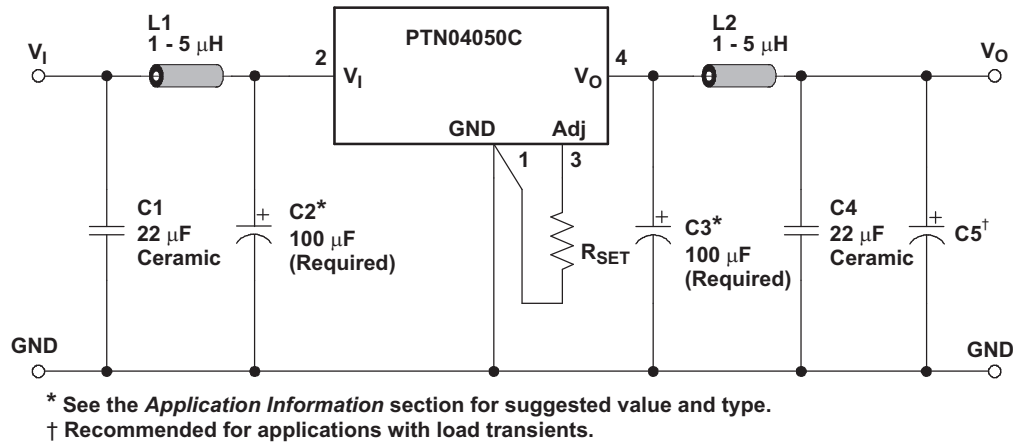

**Figure 18. Adding π Filters**

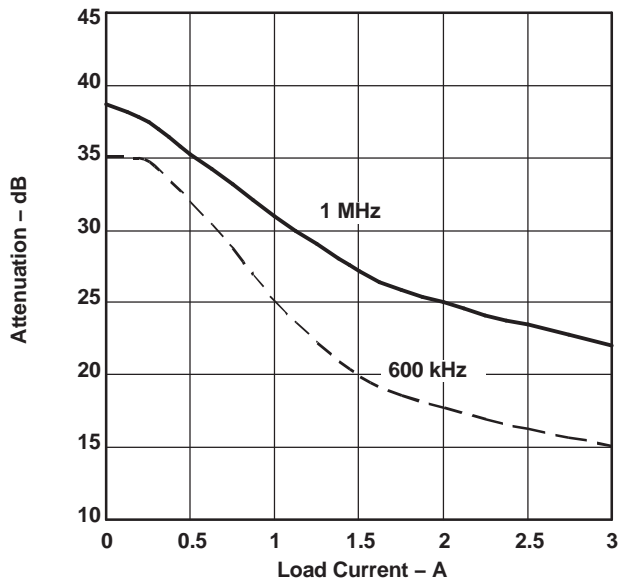

**Figure 19. π-Filter Attenuation vs. Load Current**

### REVISION HISTORY

<b>Changes from Original (September 2005) to Revision A</b>	<b>Page</b>
• Changed the Abs Max Ratings Storage temperature from: -40°C to 125°C To: -55°C to 125°C .....	<a href="#">2</a>
• Changed Note 2 of the ELECTRICAL CHARACTERISTICS table .....	<a href="#">3</a>

**PACKAGING INFORMATION**

Orderable Device	Status (1)	Package Type	Package Drawing	Pins	Package Qty	Eco Plan (2)	Lead/Ball Finish	MSL Peak Temp (3)	Op Temp (°C)	Top-Side Markings (4)	Samples
PTN04050CAD	ACTIVE	Through-Hole Module	EUU	4	56	Pb-Free (RoHS)	SN	N / A for Pkg Type	-40 to 85		<a href="#">Samples</a>
PTN04050CAH	ACTIVE	Through-Hole Module	EUU	4	56	Pb-Free (RoHS)	SN	N / A for Pkg Type	-40 to 85		<a href="#">Samples</a>
PTN04050CAS	ACTIVE	Surface Mount Module	EUV	4	56	TBD	SNPB	Level-1-235C-UNLIM/ Level-3-260C-168HRS	-40 to 85		<a href="#">Samples</a>
PTN04050CAST	ACTIVE	Surface Mount Module	EUV	4	250	TBD	SNPB	Level-1-235C-UNLIM/ Level-3-260C-168HRS	-40 to 85		<a href="#">Samples</a>
PTN04050CAZ	ACTIVE	Surface Mount Module	EUV	4	56	Pb-Free (RoHS)	SNAGCU	Level-3-260C-168 HR	-40 to 85		<a href="#">Samples</a>
PTN04050CAZT	ACTIVE	Surface Mount Module	EUV	4	250	Pb-Free (RoHS)	SNAGCU	Level-3-260C-168 HR	-40 to 85		<a href="#">Samples</a>

(1) The marketing status values are defined as follows:

**ACTIVE:** Product device recommended for new designs.

**LIFEBUY:** TI has announced that the device will be discontinued, and a lifetime-buy period is in effect.

**NRND:** Not recommended for new designs. Device is in production to support existing customers, but TI does not recommend using this part in a new design.

**PREVIEW:** Device has been announced but is not in production. Samples may or may not be available.

**OBSOLETE:** TI has discontinued the production of the device.

(2) Eco Plan - The planned eco-friendly classification: Pb-Free (RoHS), Pb-Free (RoHS Exempt), or Green (RoHS & no Sb/Br) - please check <http://www.ti.com/productcontent> for the latest availability information and additional product content details.

**TBD:** The Pb-Free/Green conversion plan has not been defined.

**Pb-Free (RoHS):** TI's terms "Lead-Free" or "Pb-Free" mean semiconductor products that are compatible with the current RoHS requirements for all 6 substances, including the requirement that lead not exceed 0.1% by weight in homogeneous materials. Where designed to be soldered at high temperatures, TI Pb-Free products are suitable for use in specified lead-free processes.

**Pb-Free (RoHS Exempt):** This component has a RoHS exemption for either 1) lead-based flip-chip solder bumps used between the die and package, or 2) lead-based die adhesive used between the die and leadframe. The component is otherwise considered Pb-Free (RoHS compatible) as defined above.

**Green (RoHS & no Sb/Br):** TI defines "Green" to mean Pb-Free (RoHS compatible), and free of Bromine (Br) and Antimony (Sb) based flame retardants (Br or Sb do not exceed 0.1% by weight in homogeneous material)

(3) MSL, Peak Temp. -- The Moisture Sensitivity Level rating according to the JEDEC industry standard classifications, and peak solder temperature.

(4) Multiple Top-Side Markings will be inside parentheses. Only one Top-Side Marking contained in parentheses and separated by a "~" will appear on a device. If a line is indented then it is a continuation of the previous line and the two combined represent the entire Top-Side Marking for that device.

**Important Information and Disclaimer:** The information provided on this page represents TI's knowledge and belief as of the date that it is provided. TI bases its knowledge and belief on information provided by third parties, and makes no representation or warranty as to the accuracy of such information. Efforts are underway to better integrate information from third parties. TI has taken and continues to take reasonable steps to provide representative and accurate information but may not have conducted destructive testing or chemical analysis on incoming materials and chemicals. TI and TI suppliers consider certain information to be proprietary, and thus CAS numbers and other limited information may not be available for release.

In no event shall TI's liability arising out of such information exceed the total purchase price of the TI part(s) at issue in this document sold by TI to Customer on an annual basis.



**EUU (R-PDSS-T4)**

**DOUBLE SIDED MODULE**

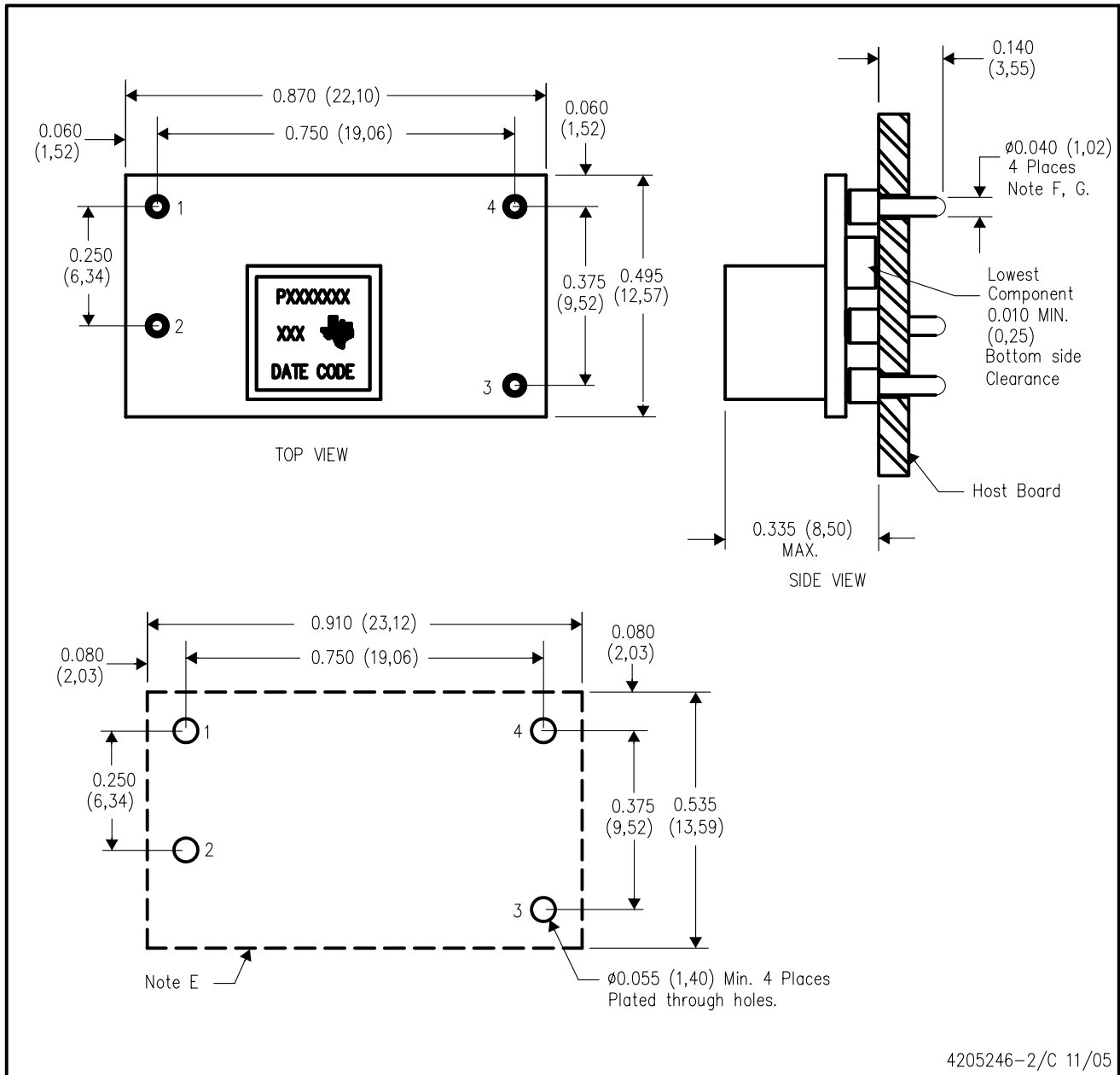

4205246-2/C 11/05

- NOTES:
- A. All linear dimensions are in inches (mm).
  - B. This drawing is subject to change without notice.
  - C. 2 place decimals are  $\pm 0.030$  ( $\pm 0,76\text{mm}$ ).
  - D. 3 place decimals are  $\pm 0.010$  ( $\pm 0,25\text{mm}$ ).
  - E. Recommended keep out area for user components.
  - F. Pins are 0.040" (1,02) diameter with 0.070" (1,78) diameter standoff shoulder.
  - G. All pins: Material - Copper Alloy  
Finish - Tin (100%) over Nickel plate

**EUV (R-PDSS-B4)**

**DOUBLE SIDED MODULE**

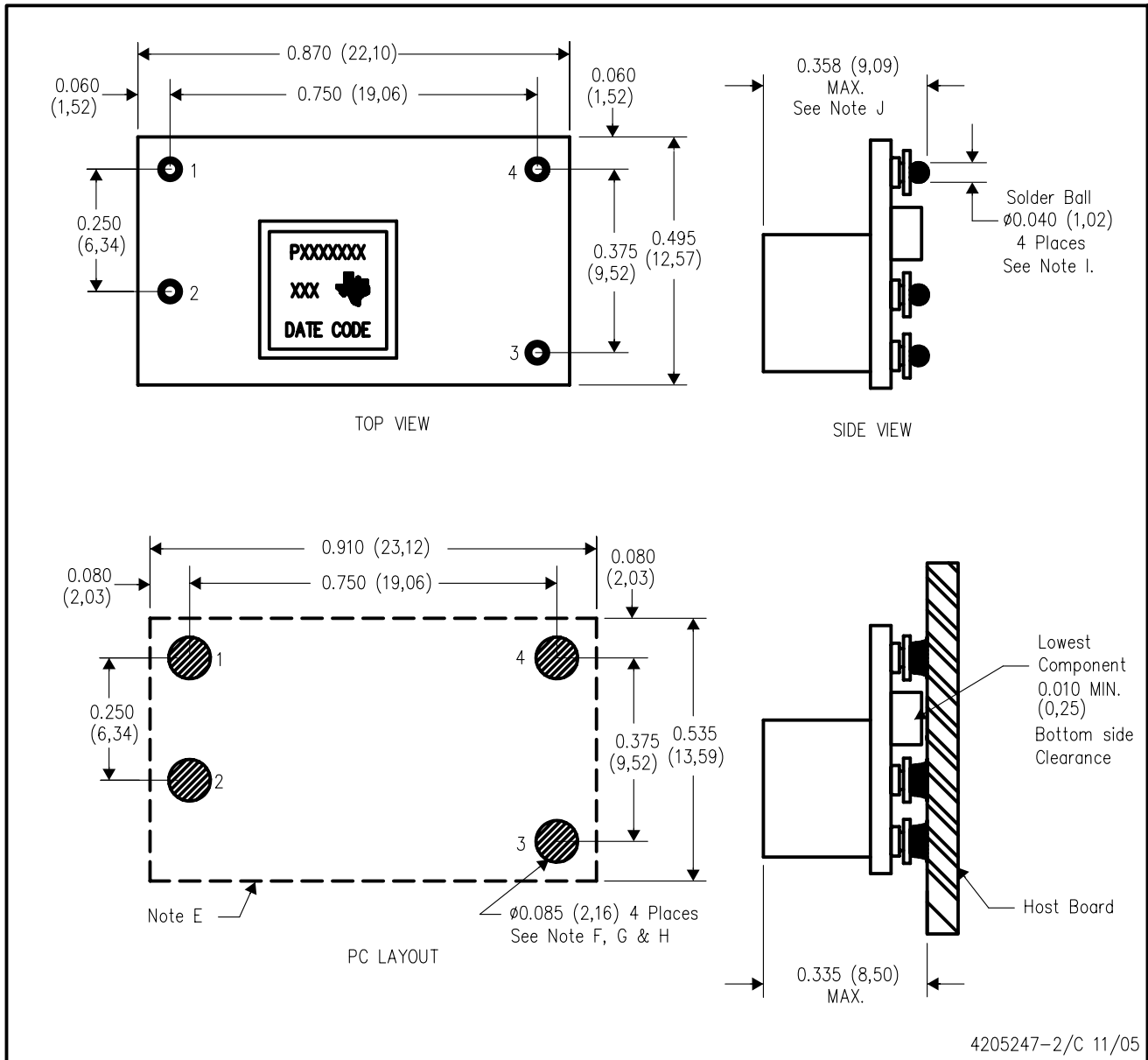

4205247-2/C 11/05

- NOTES:
- A. All linear dimensions are in inches (mm).
  - B. This drawing is subject to change without notice.
  - C. 2 place decimals are  $\pm 0.030$  ( $\pm 0,76$ mm).
  - D. 3 place decimals are  $\pm 0.010$  ( $\pm 0,25$ mm).
  - E. Recommended keep out area for user components.
  - F. Power pin connection should utilize two or more vias to the interior power plane of 0.025 (0,63) I.D. per input, ground and output pin (or the electrical equivalent).
  - G. Paste screen opening: 0.080 (2,03) to 0.085 (2,16). Paste screen thickness: 0.006 (0,15).
  - H. Pad type: Solder mask defined.
  - I. All pins: Material - Copper Alloy  
Finish - Tin (100%) over Nickel plate  
Solder Ball - See product data sheet.
  - J. Dimension prior to reflow solder.

## IMPORTANT NOTICE

Texas Instruments Incorporated and its subsidiaries (TI) reserve the right to make corrections, enhancements, improvements and other changes to its semiconductor products and services per JESD46, latest issue, and to discontinue any product or service per JESD48, latest issue. Buyers should obtain the latest relevant information before placing orders and should verify that such information is current and complete. All semiconductor products (also referred to herein as "components") are sold subject to TI's terms and conditions of sale supplied at the time of order acknowledgment.

TI warrants performance of its components to the specifications applicable at the time of sale, in accordance with the warranty in TI's terms and conditions of sale of semiconductor products. Testing and other quality control techniques are used to the extent TI deems necessary to support this warranty. Except where mandated by applicable law, testing of all parameters of each component is not necessarily performed.

TI assumes no liability for applications assistance or the design of Buyers' products. Buyers are responsible for their products and applications using TI components. To minimize the risks associated with Buyers' products and applications, Buyers should provide adequate design and operating safeguards.

TI does not warrant or represent that any license, either express or implied, is granted under any patent right, copyright, mask work right, or other intellectual property right relating to any combination, machine, or process in which TI components or services are used. Information published by TI regarding third-party products or services does not constitute a license to use such products or services or a warranty or endorsement thereof. Use of such information may require a license from a third party under the patents or other intellectual property of the third party, or a license from TI under the patents or other intellectual property of TI.

Reproduction of significant portions of TI information in TI data books or data sheets is permissible only if reproduction is without alteration and is accompanied by all associated warranties, conditions, limitations, and notices. TI is not responsible or liable for such altered documentation. Information of third parties may be subject to additional restrictions.

Resale of TI components or services with statements different from or beyond the parameters stated by TI for that component or service voids all express and any implied warranties for the associated TI component or service and is an unfair and deceptive business practice. TI is not responsible or liable for any such statements.

Buyer acknowledges and agrees that it is solely responsible for compliance with all legal, regulatory and safety-related requirements concerning its products, and any use of TI components in its applications, notwithstanding any applications-related information or support that may be provided by TI. Buyer represents and agrees that it has all the necessary expertise to create and implement safeguards which anticipate dangerous consequences of failures, monitor failures and their consequences, lessen the likelihood of failures that might cause harm and take appropriate remedial actions. Buyer will fully indemnify TI and its representatives against any damages arising out of the use of any TI components in safety-critical applications.

In some cases, TI components may be promoted specifically to facilitate safety-related applications. With such components, TI's goal is to help enable customers to design and create their own end-product solutions that meet applicable functional safety standards and requirements. Nonetheless, such components are subject to these terms.

No TI components are authorized for use in FDA Class III (or similar life-critical medical equipment) unless authorized officers of the parties have executed a special agreement specifically governing such use.

Only those TI components which TI has specifically designated as military grade or "enhanced plastic" are designed and intended for use in military/aerospace applications or environments. Buyer acknowledges and agrees that any military or aerospace use of TI components which have **not** been so designated is solely at the Buyer's risk, and that Buyer is solely responsible for compliance with all legal and regulatory requirements in connection with such use.

TI has specifically designated certain components as meeting ISO/TS16949 requirements, mainly for automotive use. In any case of use of non-designated products, TI will not be responsible for any failure to meet ISO/TS16949.

### Products

Audio	<a href="http://www.ti.com/audio">www.ti.com/audio</a>
Amplifiers	<a href="http://amplifier.ti.com">amplifier.ti.com</a>
Data Converters	<a href="http://dataconverter.ti.com">dataconverter.ti.com</a>
DLP® Products	<a href="http://www.dlp.com">www.dlp.com</a>
DSP	<a href="http://dsp.ti.com">dsp.ti.com</a>
Clocks and Timers	<a href="http://www.ti.com/clocks">www.ti.com/clocks</a>
Interface	<a href="http://interface.ti.com">interface.ti.com</a>
Logic	<a href="http://logic.ti.com">logic.ti.com</a>
Power Mgmt	<a href="http://power.ti.com">power.ti.com</a>
Microcontrollers	<a href="http://microcontroller.ti.com">microcontroller.ti.com</a>
RFID	<a href="http://www.ti-rfid.com">www.ti-rfid.com</a>
OMAP Applications Processors	<a href="http://www.ti.com/omap">www.ti.com/omap</a>
Wireless Connectivity	<a href="http://www.ti.com/wirelessconnectivity">www.ti.com/wirelessconnectivity</a>

### Applications

Automotive and Transportation	<a href="http://www.ti.com/automotive">www.ti.com/automotive</a>
Communications and Telecom	<a href="http://www.ti.com/communications">www.ti.com/communications</a>
Computers and Peripherals	<a href="http://www.ti.com/computers">www.ti.com/computers</a>
Consumer Electronics	<a href="http://www.ti.com/consumer-apps">www.ti.com/consumer-apps</a>
Energy and Lighting	<a href="http://www.ti.com/energy">www.ti.com/energy</a>
Industrial	<a href="http://www.ti.com/industrial">www.ti.com/industrial</a>
Medical	<a href="http://www.ti.com/medical">www.ti.com/medical</a>
Security	<a href="http://www.ti.com/security">www.ti.com/security</a>
Space, Avionics and Defense	<a href="http://www.ti.com/space-avionics-defense">www.ti.com/space-avionics-defense</a>
Video and Imaging	<a href="http://www.ti.com/video">www.ti.com/video</a>

### TI E2E Community

[e2e.ti.com](http://e2e.ti.com)

# AMEYA360

## Components Supply Platform

Authorized Distribution Brand :



Website :

Welcome to visit [www.ameya360.com](http://www.ameya360.com)

Contact Us :

➤ Address :

401 Building No.5, JiuGe Business Center, Lane 2301, Yishan Rd  
Minhang District, Shanghai , China

➤ Sales :

Direct +86 (21) 6401-6692

Email [amall@ameya360.com](mailto:amall@ameya360.com)

QQ 800077892

Skype [ameyasales1](#) [ameyasales2](#)

➤ Customer Service :

Email [service@ameya360.com](mailto:service@ameya360.com)

➤ Partnership :

Tel +86 (21) 64016692-8333

Email [mkt@ameya360.com](mailto:mkt@ameya360.com)