

## 10 A Synchronous DC-DC Step down Regulator with low quiescent power mode ( $V_{IN} = 4.5\text{ V to }24\text{ V}$ , $V_{OUT} = 0.75\text{ V to }3.6\text{ V}$ )

### FEATURES

- High-Speed Response DC-DC Step Down Regulator Circuit that employs Hysteretic Control System
- Hi-side 20 mΩ (Typ), Low-side 6 mΩ (Typ) MOSFETs for High efficiency at 10 A
- Low Power Mode (discontinuous) for Light Load Efficiency
- Maximum Output Current : 10 A
- Input Voltage Range :  $AV_{IN} = 4.5\text{ V to }24\text{ V}$ ,  
 $PV_{IN} = 4.5\text{ V to }24\text{ V}$ ,  
 $V_5 = 4.5\text{ V to }5.5\text{ V}$
- Output Voltage Range : 0.75 V to 3.6 V
- Selectable Switching Frequency 430 kHz / 630 kHz
- Built-in Feed Back Resistors for 1.2 V / 1.05 V Output Voltage (Also configurable using External Resistors)
- Adjustable Soft Start
- Selectable Low Operating and Standby Quiescent Current to achieve light load efficiency
- Open Drain Power Good Indication for Output Over / Under Voltage
- Built-in Under Voltage Lockout (UVLO), Thermal Shut Down (TSD), Under Voltage Detection (UVD), Over Voltage Detection (OVD), Short Circuit Protection (SCP), Over Current Protection (OCP),
- 24 pin Plastic Quad Flat Non-leded Package Heat Slug Down (QFN Type)  
(Size : 4 mm × 4 mm × 0.7 mm, 0.5 mm pitch)

### DESCRIPTION

NN30332A is a synchronous DC-DC Step down Regulator (1-ch) comprising of a Controller IC and two power MOSFETs and employs the hysteretic control system.

By this system, when load current changes suddenly, it responds at high speed and minimizes the changes of output voltage.

Since it is possible to use capacitors with small capacitance and it is unnecessary to add external parts for system phase compensation, this IC realizes downsizing of set and reducing in the number of external parts. Output voltage is adjustable by user. Maximum current is 10 A.

### APPLICATIONS

High Current Distributed Power Systems such as

- PCs
- HDDs (Hard Disk Drives)
- SSDs (Solid State Drives)
- Game consoles
- Servers
- Security Cameras
- Network TVs
- Home Appliances
- OA Equipment etc.

### SIMPLIFIED APPLICATION

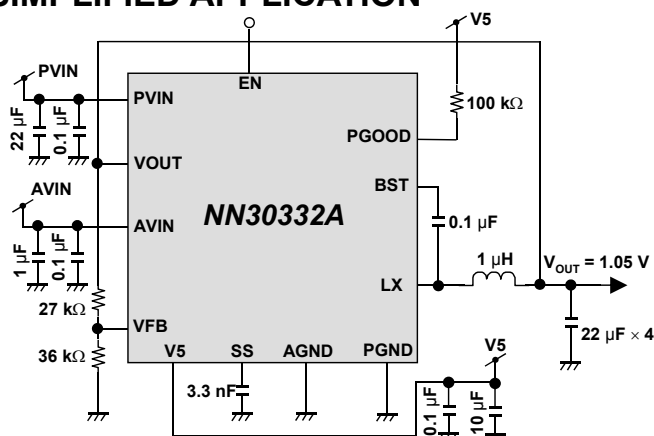

Note : The application circuit is an example. The operation of the mass production set is not guaranteed. Sufficient evaluation and verification is required in the design of the mass production set. The Customer is fully responsible for the incorporation of the above illustrated application circuit in the design of the equipment.

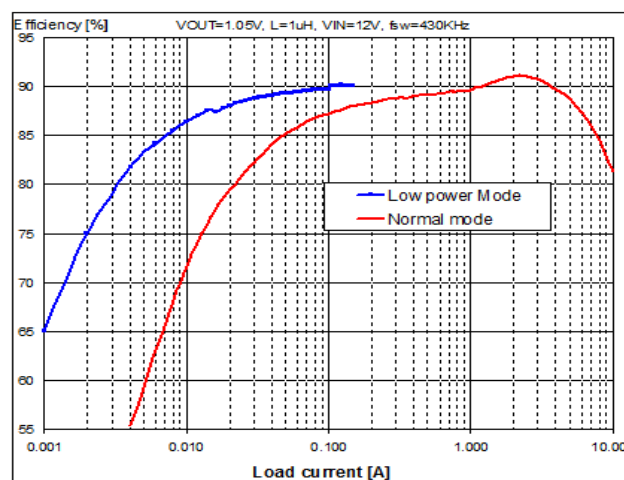

Condition :  
 $V_{IN} = 12\text{ V}$ ,  $V_{OUT}$  Setting = 1.05 V,  
 Switching Frequency = 430 kHz, Low Power Mode / Normal Mode,  
 $L_O = 1\text{ }\mu\text{H}$ ,  $C_O = 88\text{ }\mu\text{F}$  (22  $\mu\text{F} \times 4$ ) #Including V5 current

**ORDERING INFORMATION**

Order Number	Feature	Package	Output Supply
NN30332A-VB	Maximum Output Current : 10 A	24 pin HQFN	Emboss Taping

**ABSOLUTE MAXIMUM RATINGS**

Parameter	Symbol	Rating	Unit	Notes
Supply voltage 1	$V_{IN}$	30	V	*1
Supply voltage 2	$V_5$	6	V	*1
Operating free-air temperature	$T_{opr}$	- 40 to + 85	°C	*2
Operating junction temperature	$T_j$	- 40 to + 150	°C	*2
Storage temperature	$T_{stg}$	- 55 to + 150	°C	*2
Input Voltage Range	$V_{LP}, V_{FSEL}, V_{OUT}, V_{FB}$	- 0.3 to ( $V_5 + 0.3$ )	V	*1 *3
	$V_{EN}$	- 0.3 to 6.0	V	*1
Output Voltage Range	$V_{PGOOD}$	- 0.3 to ( $V_5 + 0.3$ )	V	*1 *3
	$V_{LX}$	- 0.3 to ( $V_{IN} + 0.3$ )	V	*1 *4
ESD	HBM	2	kV	—

Notes : This product may sustain permanent damage if subjected to conditions higher than the above stated absolute maximum rating. This rating is the maximum rating and device operating at this range is not guaranteed as it is higher than our stated recommended operating range.

When subjected under the absolute maximum rating for a long time, the reliability of the product may be affected.

$V_{IN}$  is voltage for AVIN, PVIN.  $V_{IN} = AV_{IN} = PV_{IN}$ .

Do not apply external currents and voltages to any pin not specifically mentioned.

\*1 : The values under the condition not exceeding the above absolute maximum ratings and the power dissipation.

\*2 : Except for the power dissipation, operating ambient temperature, and storage temperature, all ratings are for  $T_a = 25$  °C.

\*3 : ( $V_5 + 0.3$ ) V must not exceed 6 V.

\*4 : ( $V_{IN} + 0.3$ ) V must not exceed 30 V.

**POWER DISSIPATION RATING**

Package	$\theta_{j-a}$	$\theta_{j-c}$	PD (Ta = 25 °C)	PD (Ta = 85 °C)	Notes
24 pin Plastic Quad Flat Non-leaded Package Heat Slug Down (QFN Type)	50.4 °C / W	4.5 °C / W	2.480 W	1.290 W	*1
	33.3 °C / W	3.6 °C / W	3.754 W	1.858 W	*2

Notes : For the actual usage, please follow the power supply voltage, load and ambient temperature conditions to ensure that there is enough margin and the thermal design does not exceed the allowable value.

\*1:Glass Epoxy Substrate (4 Layers) [50 × 50 × 0.8 t (mm)]

\*2:Glass Epoxy Substrate (4 Layers) [50 × 50 × 1.57 t (mm)]



**CAUTION**

Although this IC has built-in ESD protection circuit, it may still sustain permanent damage if not handled properly. Therefore, proper ESD precautions are recommended to avoid electrostatic damage to the MOS gates.

**RECOMMENDED OPERATING CONDITIONS**

Parameter	Symbol	Min	Typ	Max	Unit	Notes
Supply voltage range	AV <sub>IN</sub>	4.5	12.0	24.0	V	—
	PV <sub>IN</sub>	4.5	12.0	24.0	V	—
	V <sub>5</sub>	4.5	5.0	5.5	V	—
Input Voltage Range	V <sub>LP</sub>	-0.3	—	V <sub>5</sub> + 0.3	V	*1
	V <sub>FSEL</sub>	-0.3	—	V <sub>5</sub> + 0.3	V	*1
	V <sub>EN</sub>	-0.3	—	5.0	V	—
Output Voltage Range	V <sub>PGOOD</sub>	-0.3	—	V <sub>5</sub> + 0.3	V	*1
	V <sub>LX</sub>	-0.3	—	V <sub>IN</sub> + 0.3	V	*2

Notes : Voltage values, unless otherwise specified, are with respect to GND.

GND is voltage for AGND, PGND. AGND = PGND

V<sub>IN</sub> is voltage for AVIN, PVIN. V<sub>IN</sub> = AV<sub>IN</sub> = PV<sub>IN</sub>.

Do not apply external currents or voltages to any pin not specifically mentioned.

\*1 : (V<sub>5</sub> + 0.3) V must not exceed 6 V.

\*2 : (V<sub>IN</sub> + 0.3) V must not exceed 30 V.

**ELECTRICAL CHARACTERISTICS**

$C_O = 22 \mu\text{F} \times 4$ ,  $L_O = 1 \mu\text{H}$ ,  $V_{OUT}$  Setting = 1.05 V,  $V_{IN} = AV_{IN} = PV_{IN} = 12 \text{ V}$ ,  $V_5 = 5 \text{ V}$ ,  
Switching Frequency = 430 kHz,  $V_{LP} = 1 \text{ V}$  (Normal Mode),  
 $T_a = 25 \text{ }^\circ\text{C} \pm 2 \text{ }^\circ\text{C}$  unless otherwise noted.

Parameter	Symbol	Condition	Limits			Unit	Note
			Min	Typ	Max		
<b>Current Consumption</b>							
Consumption current at active (Normal Mode)	$I_{VDDACTN}$	$V_{EN} = 5 \text{ V}$ , $I_{OUT} = 0 \text{ A}$ $R_{FB1} = 27 \text{ k}\Omega$ $R_{FB2} = 36 \text{ k}\Omega$ $V_{LP} = 1 \text{ V}$ , $V_{FB} = 0.62 \text{ V}$	—	450	900	$\mu\text{A}$	—
Consumption current at active (Low Power Mode)	$I_{VDDACTL}$	$V_{EN} = 5 \text{ V}$ , $I_{OUT} = 0 \text{ A}$ $R_{FB1} = 27 \text{ k}\Omega$ $R_{FB2} = 36 \text{ k}\Omega$ $V_{LP} = 0 \text{ V}$ , $V_{FB} = 0.62 \text{ V}$	—	80	130	$\mu\text{A}$	—
V5 Consumption current at standby	$I_{V5STB}$	$V_5 = 5 \text{ V}$ , $V_{EN} = 0 \text{ V}$	—	2	4	$\mu\text{A}$	—
AVIN/PVIN Consumption current at standby	$I_{VINSTB}$	$AV_{IN} = PV_{IN} = 7.4 \text{ V}$ $V_{EN} = 0 \text{ V}$	—	1	2	$\mu\text{A}$	—
<b>Logic Pin Characteristics</b>							
EN pin Low-level input voltage	$V_{ENL}$	—	—	—	0.3	V	—
EN pin High-level input voltage	$V_{ENH}$	—	1.5	—	5.0	V	—
EN pin leakage current	$I_{LEAKEN}$	$V_{EN} = 5 \text{ V}$	—	3	7	$\mu\text{A}$	—
LP pin Low-level input voltage	$V_{LPL}$	—	—	—	0.49	V	—
LP pin High-level input voltage	$V_{LPH}$	—	0.72	—	$V_5$	V	—
LP pin leakage current	$I_{LEAKLP}$	$V_{LP} = 1 \text{ V}$	—	2	4	$\mu\text{A}$	—
FSEL pin Low-level input voltage	$V_{FSELL}$	—	—	—	0.3	V	—
FSEL pin High-level input voltage	$V_{FSELH}$	—	$V_5$ $\times 0.7$	—	$V_5$	V	—
FSEL pin leakage current	$I_{LEAKFS}$	$V_{FSEL} = 5 \text{ V}$	—	5	10	$\mu\text{A}$	—

**ELECTRICAL CHARACTERISTICS (Continued)**

$C_O = 22 \mu\text{F} \times 4$ ,  $L_O = 1 \mu\text{H}$ ,  $V_{\text{OUT}} \text{ Setting} = 1.05 \text{ V}$ ,  $V_{\text{IN}} = AV_{\text{IN}} = PV_{\text{IN}} = 12 \text{ V}$ ,  $V_5 = 5 \text{ V}$ ,

Switching Frequency = 430 kHz,  $V_{\text{LP}} = 1 \text{ V}$  (Normal Mode),

$T_a = 25 \text{ }^\circ\text{C} \pm 2 \text{ }^\circ\text{C}$  unless otherwise noted.

Parameter	Symbol	Condition	Limits			Unit	Note
			Min	Typ	Max		
<b>VFB Characteristics</b>							
VFB comparator threshold	$V_{\text{FBTH}}$	—	0.594	0.600	0.606	V	—
VFB pin leakage current 1	$I_{\text{LEAKFB1}}$	$V_{\text{FB}} = 0 \text{ V}$	-1	—	1	$\mu\text{A}$	—
VFB pin leakage current 2	$I_{\text{LEAKFB2}}$	$V_{\text{FB}} = 6 \text{ V}$	-1	—	1	$\mu\text{A}$	—
<b>Under Voltage Lock Out</b>							
UVLO shutdown voltage	$V_{\text{UVLODE}}$	$V_5 = 5 \text{ V to } 0 \text{ V}$	4.15	4.20	4.25	V	—
UVLO wakeup voltage	$V_{\text{UVLORE}}$	$V_5 = 0 \text{ V to } 5 \text{ V}$	4.35	4.40	4.45	V	—
UVLO hysteresis	$\Delta V_{\text{UVLO}}$	—	150	200	250	mV	—
<b>PGOOD</b>							
PGOOD Threshold 1 (VFB ratio for UVD detect)	$V_{\text{PGUV}}$	PGOOD : High to Low	77	85	93	%	—
PGOOD Hysteresis 1 (VFB ratio for UVD release)	$\Delta V_{\text{PGUV}}$	PGOOD : Low to High	3.5	5.0	6.5	%	—
PGOOD Threshold 2 (VFB ratio for OVD detect)	$V_{\text{PGOV}}$	PGOOD : High to Low	107	115	123	%	—
PGOOD Hysteresis 2 (VFB ratio for OVD release)	$\Delta V_{\text{PGOV}}$	PGOOD : Low to High	3.5	5.0	6.5	%	—
PGOOD start up delay time (After reached $V_{\text{FB}} = 0.6 \text{ V}$ )	$V_{\text{PDT}}$	—	0.4	1.0	1.6	ms	—
PGOOD ON resistance	$R_{\text{PG}}$	—	—	10	15	$\Omega$	—

**ELECTRICAL CHARACTERISTICS (Continued)**

$C_O = 22 \mu\text{F} \times 4$ ,  $L_O = 1 \mu\text{H}$ ,  $V_{\text{OUT}} \text{ Setting} = 1.05 \text{ V}$ ,  $V_{\text{IN}} = AV_{\text{IN}} = PV_{\text{IN}} = 12 \text{ V}$ ,  $V_5 = 5 \text{ V}$ ,  
Switching Frequency = 430 kHz,  $V_{\text{LP}} = 1 \text{ V}$  (Normal Mode),  
 $T_a = 25 \text{ }^\circ\text{C} \pm 2 \text{ }^\circ\text{C}$  unless otherwise noted.

Parameter	Symbol	Condition	Limits			Unit	Note
			Min	Typ	Max		
DC-DC Characteristics							
Output voltage 1	$V_{o1}$	$R_{\text{FB1}} = 27 \text{ k}\Omega$ $R_{\text{FB2}} = 36 \text{ k}\Omega$ $I_{\text{OUT}} = 5 \text{ A}$	1.035	1.050	1.065	V	—
Output voltage 2	$V_{o2}$	$R_{\text{FB1}} = 30 \text{ k}\Omega$ $R_{\text{FB2}} = 30 \text{ k}\Omega$ $I_{\text{OUT}} = 5 \text{ A}$	1.182	1.200	1.218	V	—
Output voltage 3	$V_{o1}$	$V_{\text{FB}} = \text{float}$ , before $V_{\text{EN}} = 0 \text{ V to } 1.5 \text{ V}$ $I_{\text{OUT}} = 5 \text{ A}$	1.035	1.050	1.065	V	—
Output voltage 4	$V_{o2}$	$V_{\text{FB}} = V_5$ , before $V_{\text{EN}} = 0 \text{ V to } 1.5 \text{ V}$ $I_{\text{OUT}} = 5 \text{ A}$	1.182	1.200	1.218	V	—
Line regulation 1	$V_{\text{LIN1}}$	$PV_{\text{IN}} = 6 \text{ V to } 24 \text{ V}$ $I_{\text{OUT}} = 150 \text{ mA}$ , $V_{\text{LP}} = 0 \text{ V}$	—	0.25	0.75	%/V	—
Line regulation 2	$V_{\text{LIN2}}$	$PV_{\text{IN}} = 6 \text{ V to } 24 \text{ V}$ $I_{\text{OUT}} = 0.5 \text{ A}$	—	0.25	0.75	%/V	—
Load regulation 1	$V_{\text{LOA1}}$	$I_{\text{OUT}} = 10 \text{ mA to } 150 \text{ mA}$ $V_{\text{LP}} = 0\text{V}$	—	1.5	—	%	*1
Load regulation 2	$V_{\text{LOA2}}$	$I_{\text{OUT}} = 10 \text{ mA to } 10 \text{ A}$	—	2.0	—	%	*1
Output ripple voltage 1	$V_{\text{RL1}}$	$I_{\text{OUT}} = 10 \text{ mA}$ $V_{\text{LP}} = 0 \text{ V or } 1 \text{ V}$	—	40	—	mV [p-p]	*1
Output ripple voltage 2	$V_{\text{RL2}}$	$I_{\text{OUT}} = 4 \text{ A}$	—	15	—	mV [p-p]	*1
Load transient response 1	$\Delta V_{\text{TR1}}$	$I_{\text{OUT}} = 100 \text{ mA to } 4 \text{ A}$ $\Delta t = 0.5 \text{ A} / \mu\text{s}$	—	20	—	mV	*1
Load transient response 2	$\Delta V_{\text{TR2}}$	$I_{\text{OUT}} = 4 \text{ A to } 100 \text{ mA}$ $\Delta t = 0.5 \text{ A} / \mu\text{s}$	—	20	—	mV	*1
High Side Power MOSFET ON resistance	$R_{\text{ONH}}$	$V_{\text{GS}} = 5.0 \text{ V}$	—	20	40	$\text{m}\Omega$	—
Low Side Power MOSFET ON resistance	$R_{\text{ONL}}$	$V_{\text{GS}} = 5.0 \text{ V}$	—	6	10	$\text{m}\Omega$	—
Min Input and output voltage difference	$V_{\text{diff}}$	$V_{\text{diff}} = V_{\text{IN}} - V_{\text{OUT}}$	—	2.5	—	V	*1

Note : \*1 : Typical design value

**ELECTRICAL CHARACTERISTICS (Continued)**

$C_O = 22 \mu\text{F} \times 4$ ,  $L_O = 1 \mu\text{H}$ ,  $V_{\text{OUT}} \text{ Setting} = 1.05 \text{ V}$ ,  $V_{\text{IN}} = AV_{\text{IN}} = PV_{\text{IN}} = 12 \text{ V}$ ,  $V_5 = 5 \text{ V}$ ,

Switching Frequency = 430 kHz,  $V_{\text{LP}} = 1 \text{ V}$  (Normal Mode),

$T_a = 25 \text{ }^\circ\text{C} \pm 2 \text{ }^\circ\text{C}$  unless otherwise noted.

Parameter	Symbol	Condition	Limits			Unit	Note
			Min	Typ	Max		
<b>PROTECTION</b>							
DC-DC Over Current Protection Limit	$I_{\text{LMT}}$	—	—	12	—	A	*1
DC-DC Short Circuit Protection Threshold	$I_{\text{short}}$	$V_{\text{FB}} = 0.6 \text{ V to } 0.0 \text{ V}$	50	60	70	%	—
Thermal Shut Down (TSD) Threshold	$T_{\text{TSDTH}}$	—	—	130	—	$^\circ\text{C}$	*1
Thermal Shut Down (TSD) Hysteresis	$T_{\text{TSDHYS}}$	—	—	30	—	$^\circ\text{C}$	*1
<b>Soft-Start Timing</b>							
SS Charge Current	$I_{\text{SSCHG}}$	$V_{\text{SS}} = 0.3 \text{ V}$	1	2	4	$\mu\text{A}$	—
SS Discharge Resistance (Shut-down)	$R_{\text{SSDIS}}$	$V_{\text{EN}} = 0 \text{ V}$	—	5	10	$\text{k}\Omega$	—
<b>Switching Frequency</b>							
DC-DC Switching Frequency 1	$DD_{\text{FSW1}}$	$I_{\text{OUT}} = 3 \text{ A}$ , $V_{\text{FSEL}} = 0 \text{ V}$	—	430	—	kHz	*1
DC-DC Switching Frequency 2	$DD_{\text{FSW2}}$	$I_{\text{OUT}} = 3 \text{ A}$ , $V_{\text{FSEL}} = V_5$	—	630	—	kHz	*1

Note : \*1 : Typical design value

**PIN CONFIGURATION**

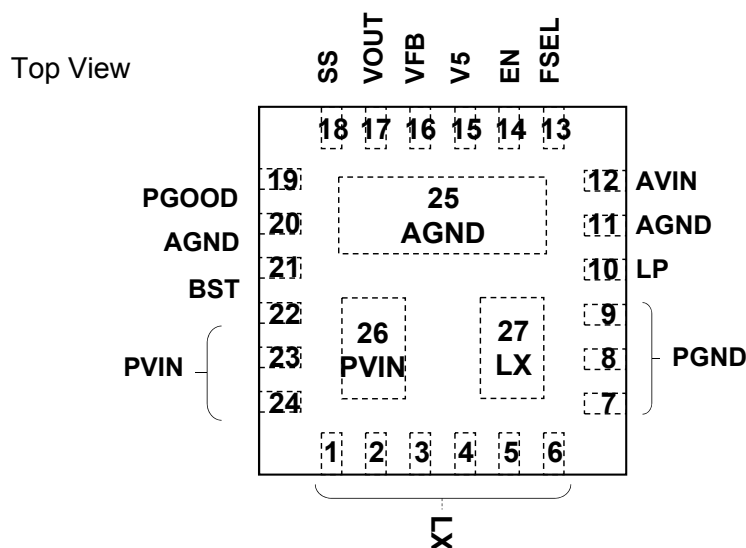

**PIN FUNCTIONS**

Pin No.	Pin name	Type	Description
1	LX	Output	Power MOSFET output pin
2			An inductor is connected and switching operation is carried out between $V_{IN}$ and GND.
3			Due to high current and large amplitude at this terminal, the parasitic inductance and impedance of the routing path can cause an increase in noise and a degradation in the efficiency.
4			Routing path should be kept as short as possible.
5			
6			
7	PGND	Ground	Ground pin for Power MOSFET
8			
9			
10	LP	Input	Low Power Mode / Normal Mode selection pin Low Power Mode is set at Low level input, Normal Mode is set at High level input.
11	AGND	Ground	Ground pin
20			
12	AVIN	Input	Power supply voltage sense pin Recommended rise time ( time to reach 90 % of set value ) setting is greater than or equal to 10 $\mu$ s and less than or equal to 1 s.
13	FSEL	Input	Frequency selection pin This is set to 430 kHz at Low level input, 630 kHz at High level input
14	EN	Input	ON / OFF control pin DC-DC is stopped at Low level input, and it is started at High level input.
15	V5	Power supply	5 V input pin (Power supply for internal control circuit)

Note : Detailed pin descriptions are provided in the OPERATION and APPLICATION INFORMATION section.

**PIN FUNCTIONS (Continued)**

Pin No.	Pin name	Type	Description
16	VFB	Input	Comparator negative input pin and 1.05 V / 1.2 V output voltage selection pin VFB terminal voltage is regulated to REF output (internal reference voltage). Since VFB is a high impedance terminal, it should not be routed near other noisy path (LX, BST, etc.) or an inductor Routing path should be kept as short as possible.
17	VOUT	Input	Output voltage sense pin Switching frequency is controlled by monitoring output voltage.
18	SS	Output	Soft start capacitor connect pin The output voltage at a start up is smoothly controlled by adjusting Soft Start time. Please connect capacitor between SS and GND.
19	PGOOD	Output	Power good open drain pin A pull up resistor between PGOOD and V5 terminal is necessary. Output is low during Over or Under Voltage Detection conditions.
21	BST	Output	High side Power MOSFET gate driver pin Bootstrap operation is carried out in order to drive the gate voltage of High side Power MOSFET. Please connect a capacitor between BST and LX. Routing path should be kept as short as possible to minimize noise.
22	PVIN	Power supply	Power supply pin for Power MOSFET Recommended rise time ( time to reach 90 % of set value ) setting is greater than or equal to 10 $\mu$ s and less than or equal to 1 s.
23			
24			
25	AGND	Ground	Ground pin for heat radiation
26	PVIN	Power supply	Power supply pin for heat radiation
27	LX	Output	Power MOSFET output pin for heat radiation

Note : Detailed pin descriptions are provided in the OPERATION and APPLICATION INFORMATION section.

**FUNCTIONAL BLOCK DIAGRAM**

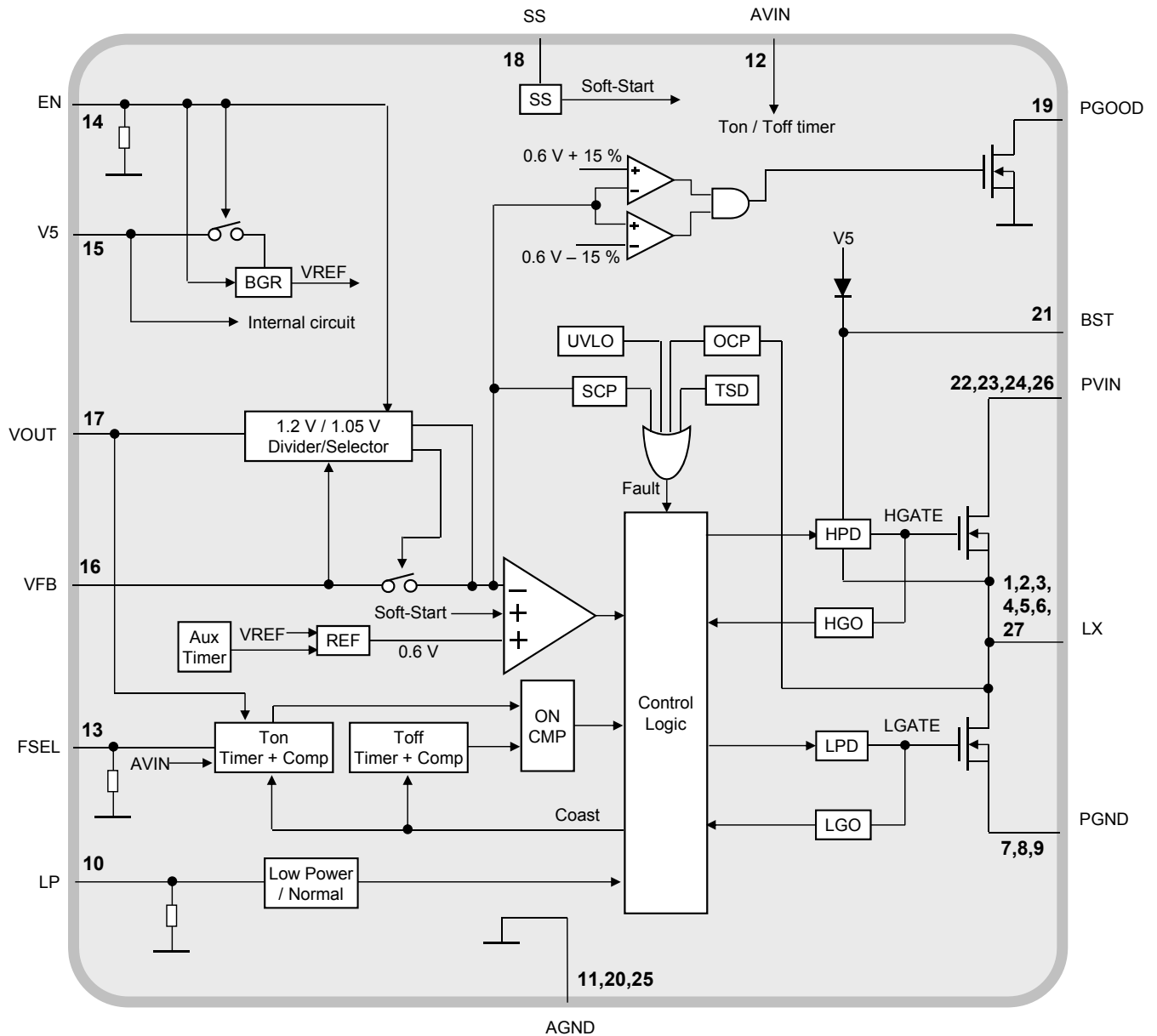

Note : This block diagram is for explaining functions. Part of the block diagram may be omitted, or it may be simplified.

## OPERATION

### 1. Protection

#### (1) Over Current Protection (OCP) and Short Circuit Protection (SCP)

- 1) The Over Current Protection is activated at about 12 A (Typ). This device uses pulse – by – pulse valley current protection method. When the low side power MOSFET is turned on, the voltage across the drain and source is monitored which is proportional to the inductor current. The high side power MOSFET is only allowed to turn on when the current flowing in the low side power MOSFET falls below the OCP level. Hence, during the OCP, the output voltage continues to drop at the specified current. OCP is a non – latch type protection.
- 2) The Short Circuit Protection function is implemented when the output voltage decreases and the VFB pin reaches to 60 % of the set voltage (0.6 V). If the VFB voltage stays below 70 % of the set voltage over 250  $\mu$ s after SCP triggers, both high side and low side power MOSFET will be latched off and the output will be discharged by internal MOSFET. Power reset or EN pin reset is necessary to activate the device again.

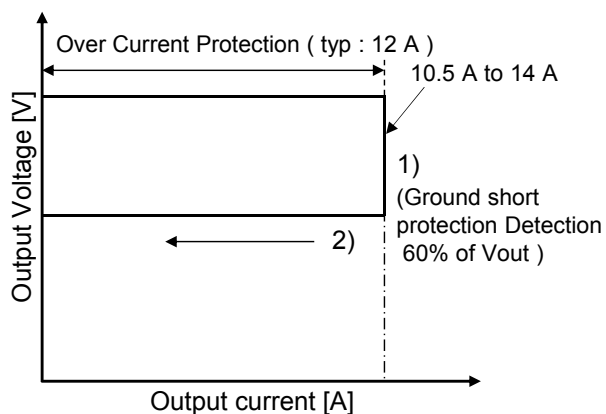

Figure : OCP and SCP Operation

#### (2) Over Voltage Detection (OVD)

If the VFB pin voltage exceeds 115 % of the set voltage (0.6 V) and lasts more than 10 ns, Over Voltage Detection will be triggered and PGOOD pin will be pulled down. Furthermore, in an over voltage condition, high side power MOSFET is turned off to stop PWM operation, and low side power MOSFET is turned on and held on until the inductor current starts to flow back to the device. If the VFB pin voltage drops below 110 % of the set voltage within 2.2 ms after Over Voltage Detection triggers, PGOOD pin will be pulled up again and PWM operation will resume. Otherwise, both high side and low side MOSFET will be latched off and the output will be discharged by internal MOSFET. Power reset or EN pin reset is necessary to activate the device again.

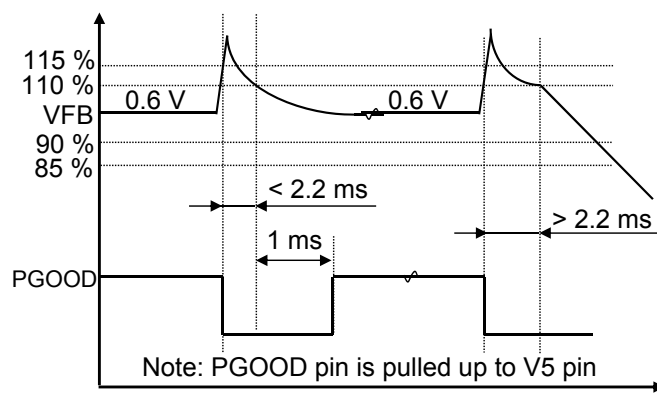

Figure : OVD Operation

#### (3) Output discharging function

When EN is low, the output is discharged by an internal MOSFET that is connected to VOUT pin. When EN is high, if the controller is turned off by Under Voltage Lock Out, or the controller is latched off by Over Voltage Detection or Short Circuit Protection, the output is discharged by the above said internal MOSFET.

The ON resistance of the internal MOSFET is 50  $\Omega$ .

**OPERATION (Continued)**

**1. Protection (Continued)**

**(4) Under Voltage Detection (UVD)**

During the operation, if the output voltage drops and VFB pin voltage reaches 85 % of the set voltage (0.6 V), the MOSFET, the drain of which is connected to PGOOD pin, will turn on and pull the voltage of PGOOD to be low. If the output voltage continues to drop and VFB pin voltage reaches 60 % of the set voltage (0.6 V), Short Circuit Protection (SCP) will be triggered. If the output voltage returns to 90 % of the set voltage (0.6 V) before triggering Short Circuit Protection, the MOSFET that is connected to PGOOD pin will turn off after 1 ms and PGOOD voltage will become logic high.

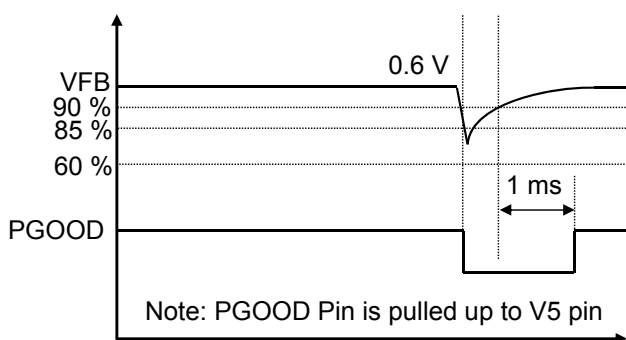

Figure : UVD Operation

**(5) Thermal Shut Down (TSD)**

When the IC internal temperature becomes more than about 130°C, TSD operates and DC-DC turns off.

**2. Pin Setting**

**(1) Operating LP Setting**

The IC can operate at two different modes : Low Power Mode and Normal Mode. In Low Power Mode, the IC is working under low current consumption to achieve light load efficiency ( $I_{OUT} < 150 \text{ mA}$ ). In Normal Mode, the IC is working at high current ability up to 10 A. The Operating Mode can be set by LP pin as follows.

LP pin	Mode
Low	Low Power Mode
High	Normal Mode

**(2) Switching Frequency Setting**

The IC can operate at two different frequency : 430 kHz and 630 kHz. The Switching Frequency can be set by FSEL pin as follows.

FSEL pin	Frequency [kHz]
Low	430
High	630

**OPERATION (Continued)**

**3. Output Voltage Setting**

The Output Voltage can be set by external resistance of VFB pin, and its calculation is as follows.

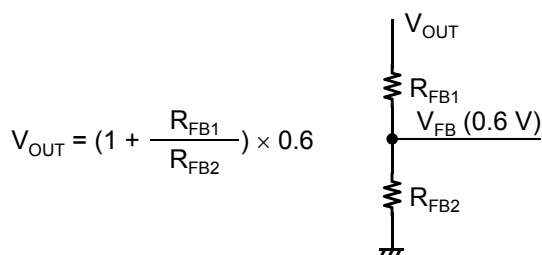

Below resistors are recommended for following popular output voltage.

V <sub>OUT</sub> [V]	R <sub>FB1</sub> [Ω]	R <sub>FB2</sub> [Ω]
3.3	54 k	12 k
1.8	36 k	18 k
1.35	30 k	24 k
1.2	30 k	30 k
1.05	27 k	36 k

VFB comparator threshold is adjusted to ± 1 %, but the actual output voltage accuracy becomes more than ± 1 % due to the influence from the circuits other than VFB comparator.

In the case of V<sub>OUT</sub> setting = 1.05 V, the actual output voltage accuracy becomes ± 1.5 %.

(V<sub>IN</sub> = 12 V, I<sub>OUT</sub> = 4 A, Switching Frequency = 430 kHz)

**4. Soft Start Setting**

Soft Start function maintains the smooth control of the output voltage during start up by adjusting soft start time. When the EN pin becomes High, the current (2 μA) begin to charge toward the external capacitor (C<sub>SS</sub>) of SS pin, and the voltage of SS pin increases straightly.

Because the voltage of VFB pin is controlled by the voltage of SS pin during start up, the voltage of VFB increase straightly to the regulation voltage (0.6 V) together with the voltage of SS pin and keep the regulation voltage after that. On the other hand, the voltage of SS pin increase to about 2.8 V and keep the voltage. The calculation of Soft Start Time is as follows.

$$\text{Soft Start Setting [s]} = \frac{0.6}{2\mu} \times C_{SS}$$

C<sub>SS</sub> : External capacitor value of SS pin

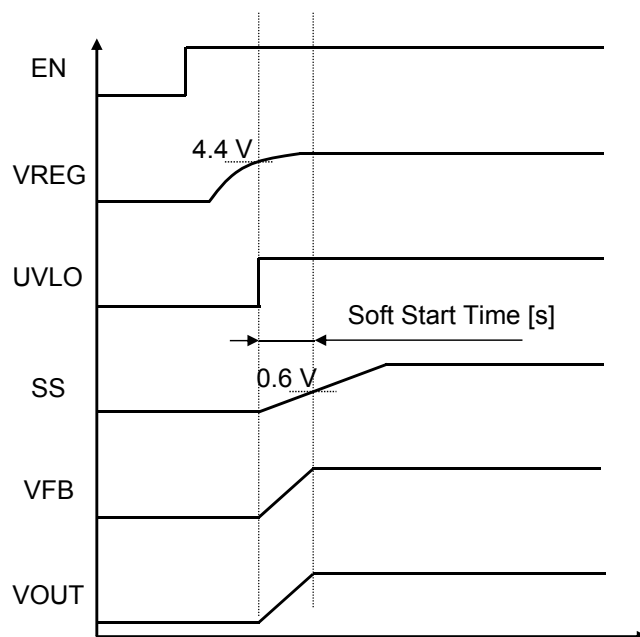

Figure : Soft Start Operation

**OPERATION (Continued)**

**5. Built-in Feed Back Resistors for 1.05 V / 1.2 V**

NN30332A has built-in feedback resistors for 1.05 V and 1.2 V output voltage.

At the timing of EN pin going from Low to High, depending on the state of VFB pin, the output voltage can be set as follows :

$V_{FB}$ [V]	$V_{OUT}$ [V]
$V_5$	1.2 V
FLOAT	1.05 V
Resistor divider	Adjustable between 0.75 V to 3.6 V

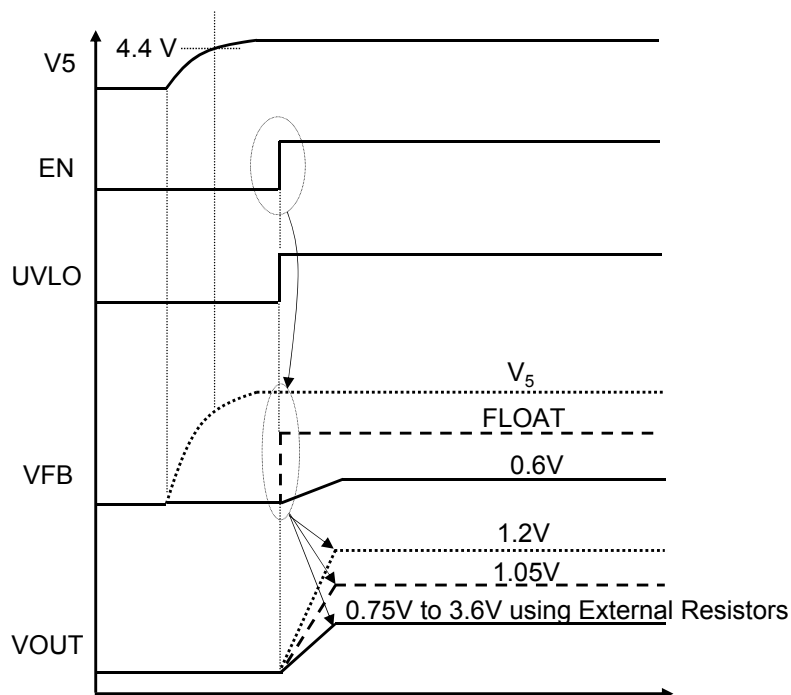
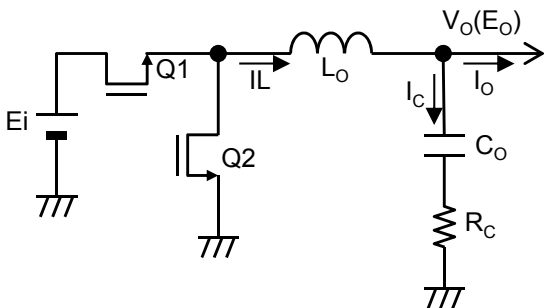
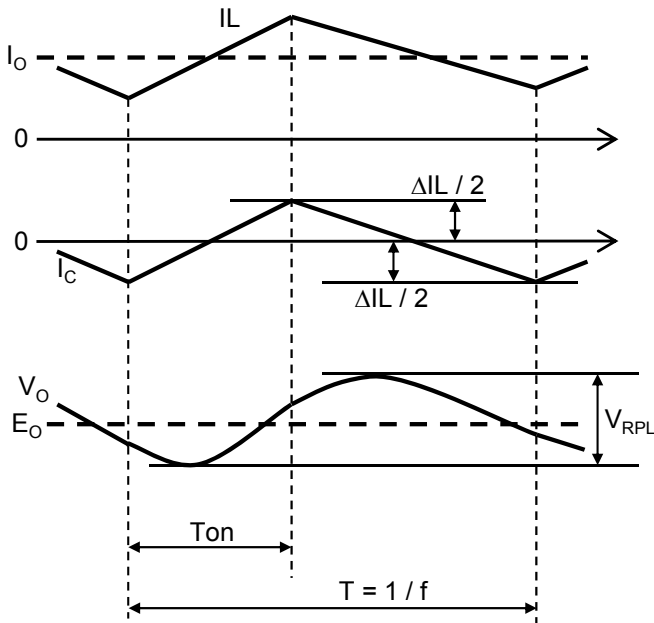

Figure : Timing chart of output voltage setting

**OPERATION (Continued)**

**6. Inductor and Output Capacitor Setting**



Given the desired input and output voltages, the inductor value and operating frequency determine the ripple current.

$$\Delta IL = \frac{E_o \cdot (E_i - E_o)}{E_i \cdot L_o \cdot f}$$

$$I_{ox} = \frac{\Delta IL}{2}$$

Highest efficiency operation is obtained at low frequency with small ripple current. However, achieving this requires a large inductor. There is a trade off among component size, efficiency and operating frequency. A reasonable starting point is to choose a ripple current that is about 40 % of  $I_o(\text{Max})$ . The largest ripple current occurs at the highest  $E_i$ . To guarantee that ripple current does not exceed a specified maximum, the inductance should be chosen according to:

$$L_o \geq \frac{E_o \cdot (E_i - E_o)}{2E_i \cdot I_{ox} \cdot f} \quad @ E_i = E_{i\_max}$$

And its maximum current rating is

$$I_{L\_max} = I_{o\_max} + \frac{\Delta IL}{2} \quad @ E_i = E_{i\_max}$$

The selection of  $C_o$  is primarily determined by the ESR ( $R_c$ ) required to minimize voltage ripple and load transients. The output ripple  $V_{RPL}$  is approximately bounded by:

$$\begin{aligned} V_{rpl} &= V_{op} - V_{ob} = E_i \cdot \frac{C_o \cdot R_c^2}{2L_o} + \frac{\Delta IL}{8C_o \cdot f} \\ &= E_i \cdot \frac{C_o \cdot R_c^2}{2L_o} + \frac{E_o \cdot (E_i - E_o)}{8E_i \cdot L_o \cdot C_o \cdot f^2} \end{aligned}$$

From the above equation, to achieve desired output ripple, low ESR ceramic capacitors are recommended, and its required RMS current rating is:

$$I_{c(\text{rms})\_max} = \frac{\Delta IL}{2\sqrt{3}} \quad @ E_i = E_{i\_max}$$

## TYPICAL CHARACTERISTICS CURVES

### 1. Output Ripple Voltage

Condition :  $V_{IN} = 12\text{ V}$ ,  $V_S = 5\text{ V}$ ,  $V_{OUT}$  Setting = 1.05 V, Switching Frequency = 430 kHz, Normal Mode,  
 $L_O = 1\text{ }\mu\text{H}$ ,  $C_O = 88\text{ }\mu\text{F}$  (22  $\mu\text{F}$  x 4)

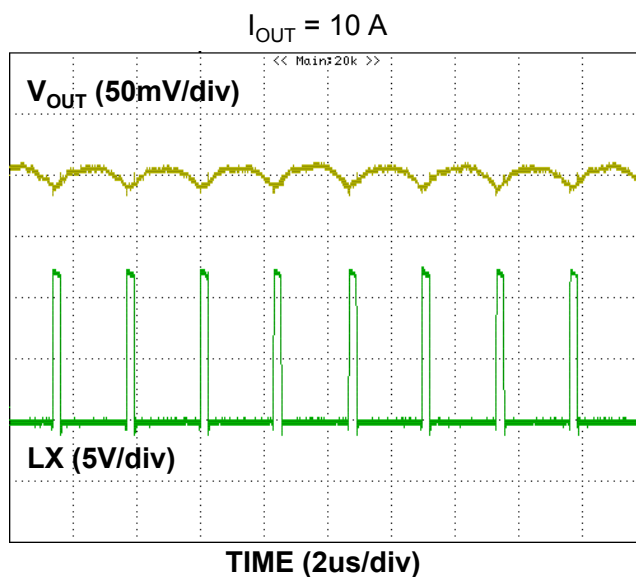
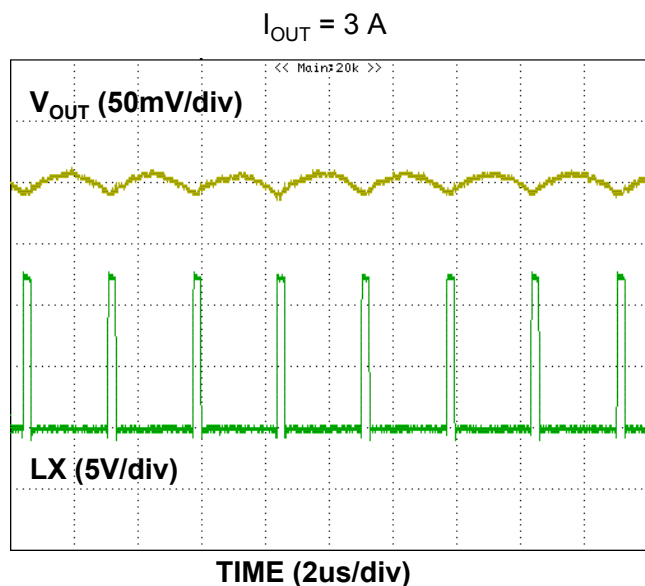
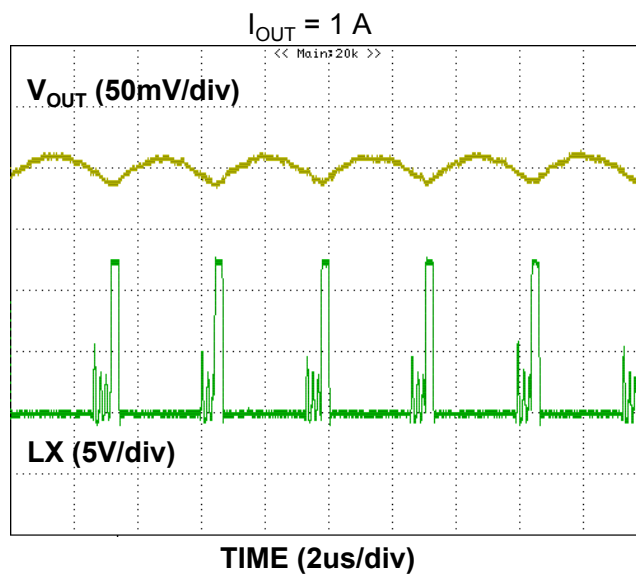
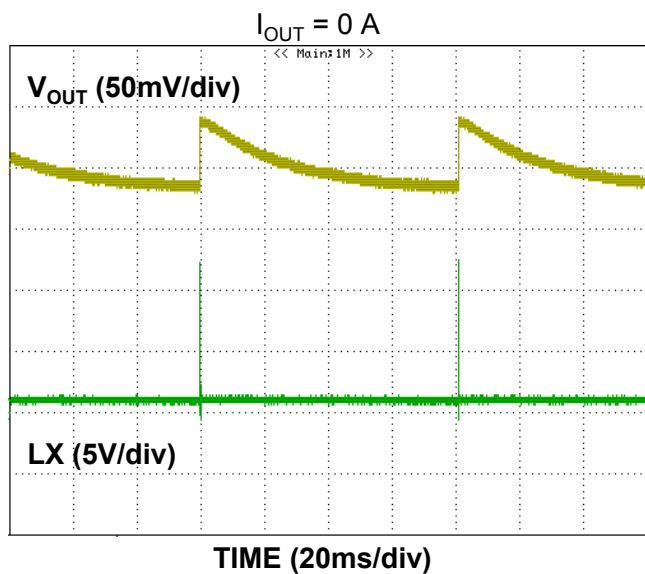

## TYPICAL CHARACTERISTICS CURVES (Continued)

### 1. Output Ripple Voltage (Continued)

Condition :  $V_{IN} = 12\text{ V}$ ,  $V_S = 5\text{ V}$ ,  $V_{OUT}$  Setting = 1.05 V, Switching Frequency = 430 kHz, Low Power Mode,  
 $L_O = 1\text{ }\mu\text{H}$ ,  $C_O = 88\text{ }\mu\text{F}$  (22  $\mu\text{F}$  x 4)

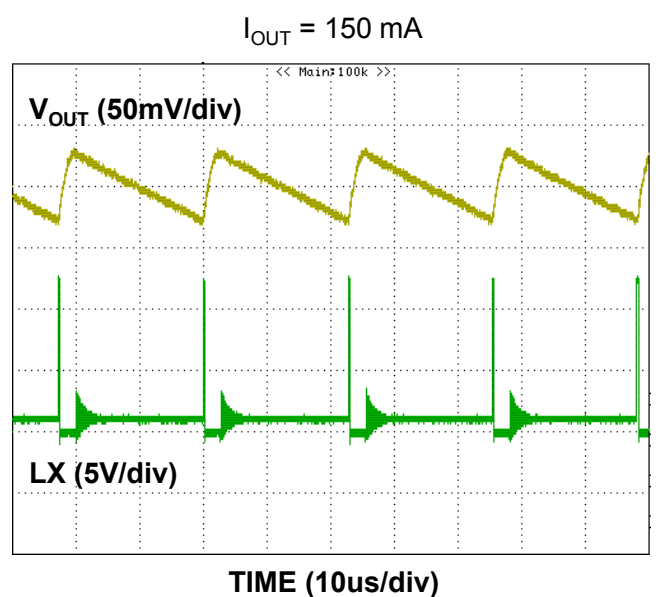
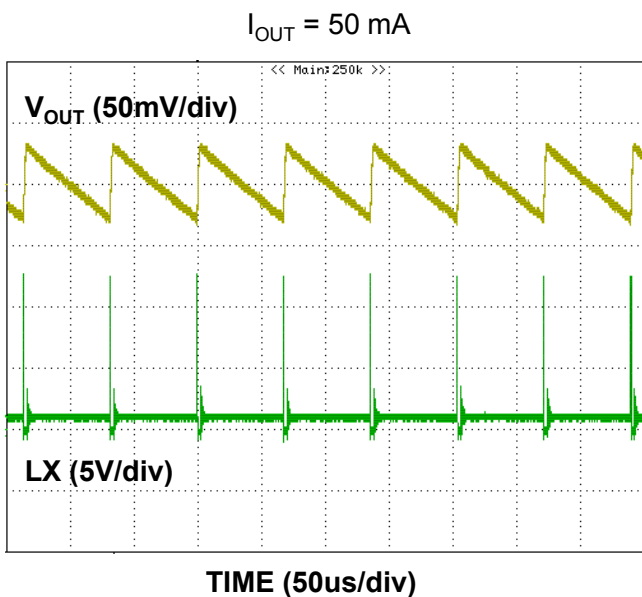
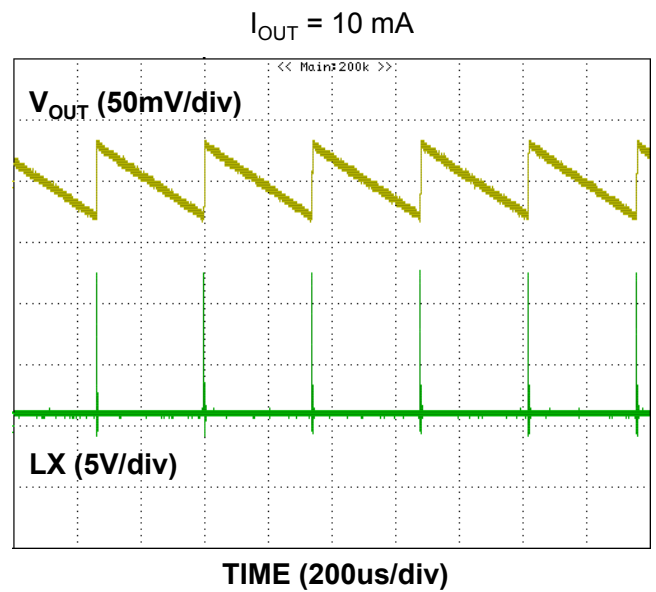
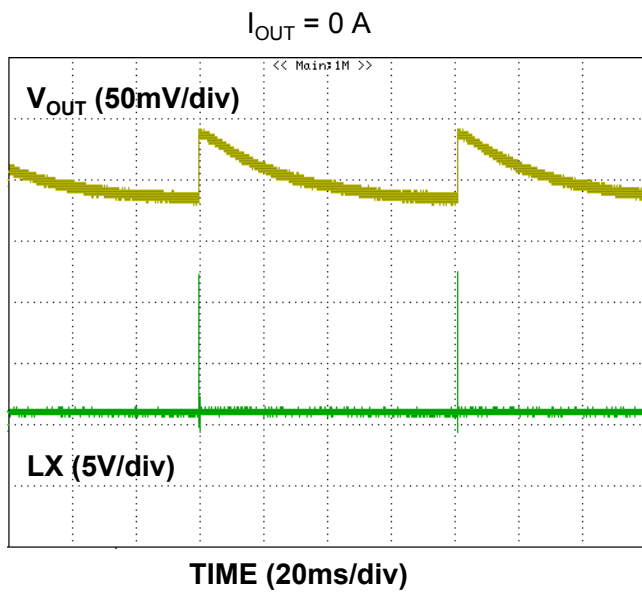

## TYPICAL CHARACTERISTICS CURVES (Continued)

### 1. Output Ripple Voltage (Continued)

Condition :  $V_{IN} = 12\text{ V}$ ,  $V_S = 5\text{ V}$ ,  $V_{OUT}$  Setting = 1.05 V, Switching Frequency = 630 kHz, Normal Mode,  
 $L_O = 1\text{ }\mu\text{H}$ ,  $C_O = 88\text{ }\mu\text{F}$  (22  $\mu\text{F}$  x 4)

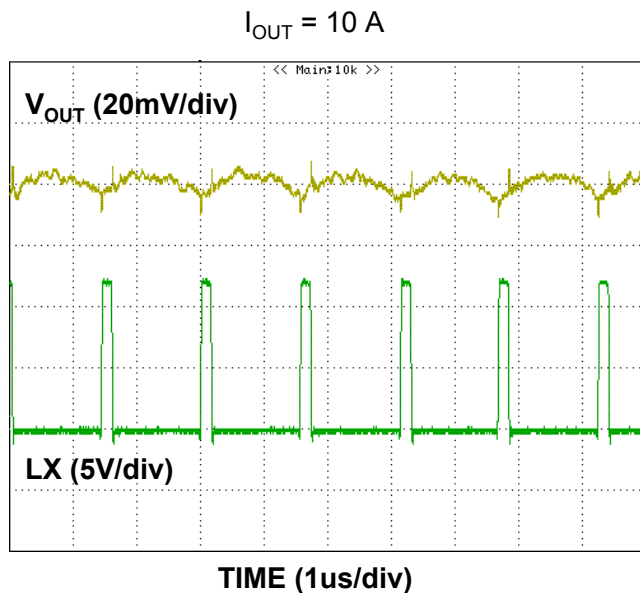
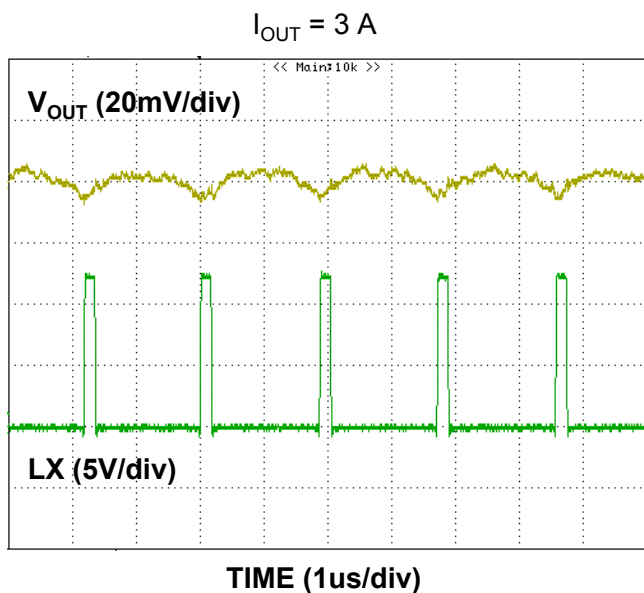
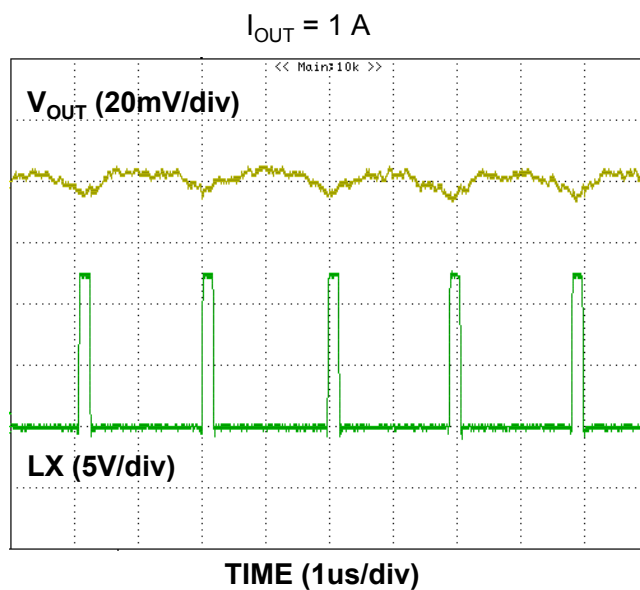
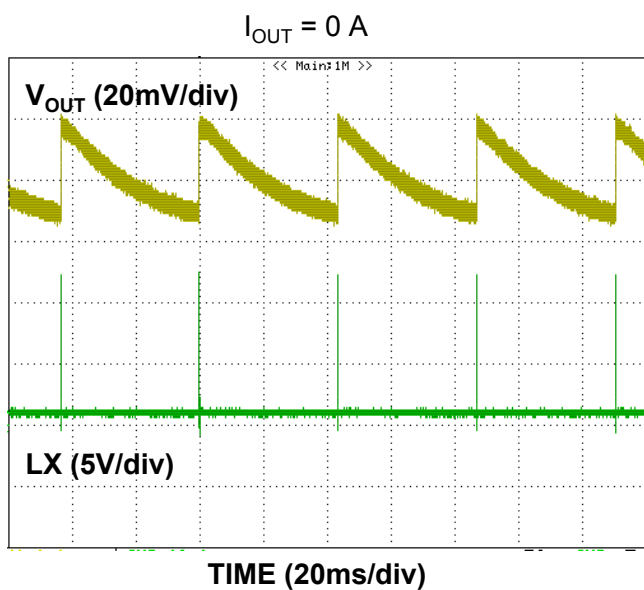

## TYPICAL CHARACTERISTICS CURVES (Continued)

### 1. Output Ripple Voltage (Continued)

Condition :  $V_{IN} = 12\text{ V}$ ,  $V_S = 5\text{ V}$ ,  $V_{OUT}$  Setting = 1.05 V, Switching Frequency = 630 kHz, Low Power Mode,  
 $L_O = 1\text{ }\mu\text{H}$ ,  $C_O = 88\text{ }\mu\text{F}$  (22  $\mu\text{F}$  x 4)

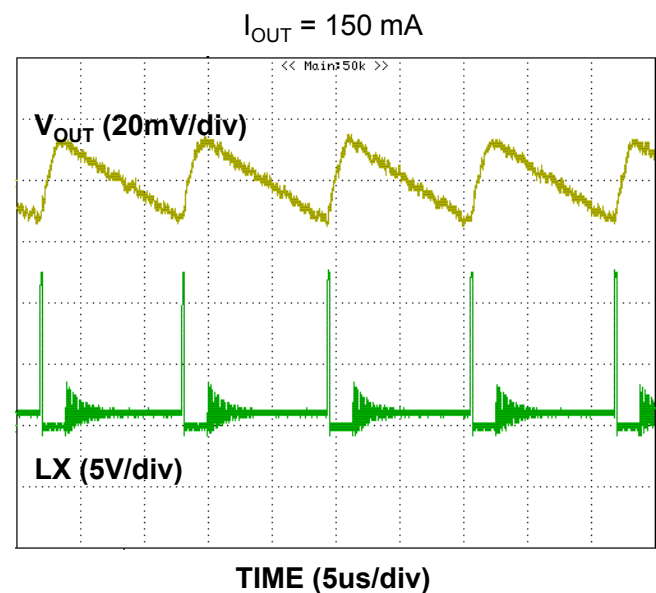
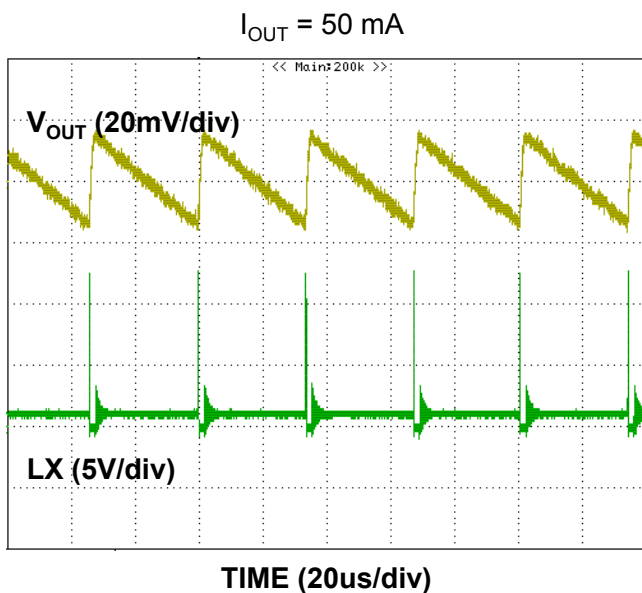
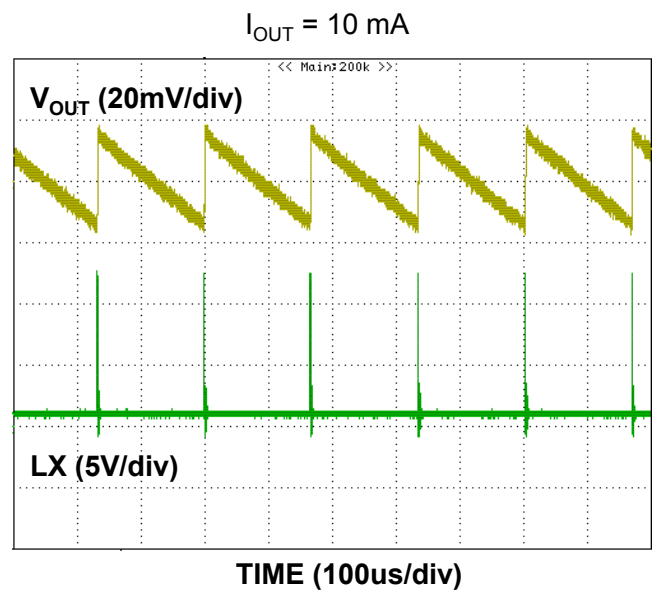
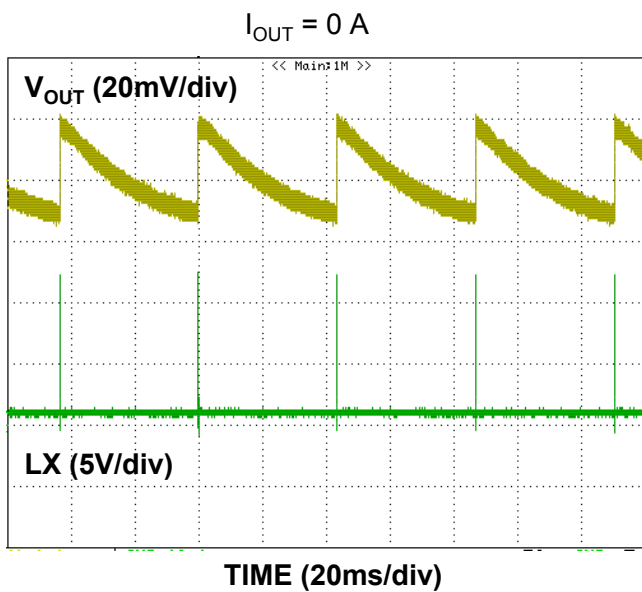

## TYPICAL CHARACTERISTICS CURVES (Continued)

### 2. Load transient response

Condition :  $V_{IN} = 12\text{ V}$ ,  $V_5 = 5\text{ V}$ ,  $V_{OUT}$  Setting =  $1.05\text{ V}$ , Switching Frequency =  $430\text{ kHz}$ , Normal Mode,  
 $L_O = 1\text{ }\mu\text{H}$ ,  $C_O = 88\text{ }\mu\text{F}$  ( $22\text{ }\mu\text{F} \times 4$ )

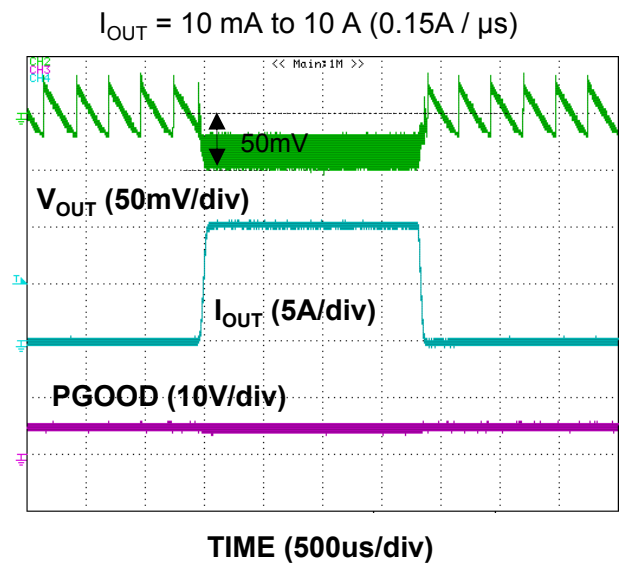
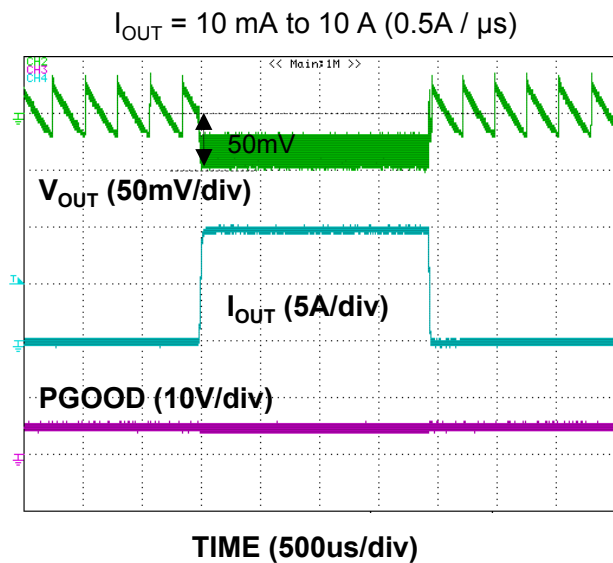

Condition :  $V_{IN} = 12\text{ V}$ ,  $V_5 = 5\text{ V}$ ,  $V_{OUT}$  Setting =  $1.05\text{ V}$ , Switching Frequency =  $430\text{ kHz}$ , Low Power Mode,  
 $L_O = 1\text{ }\mu\text{H}$ ,  $C_O = 88\text{ }\mu\text{F}$  ( $22\text{ }\mu\text{F} \times 4$ )

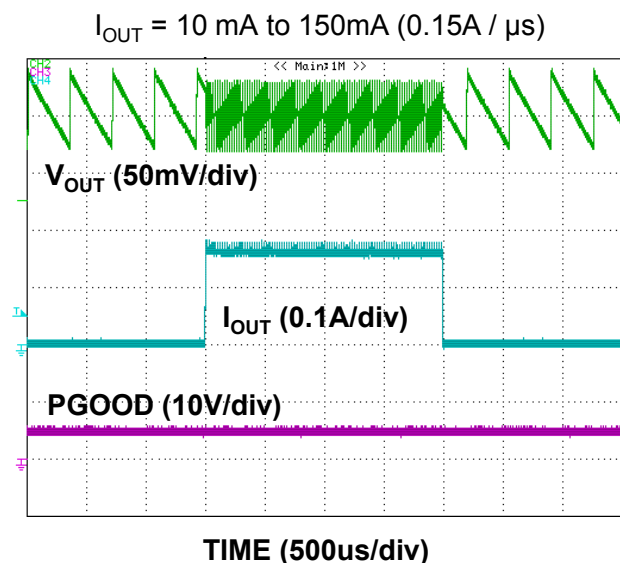
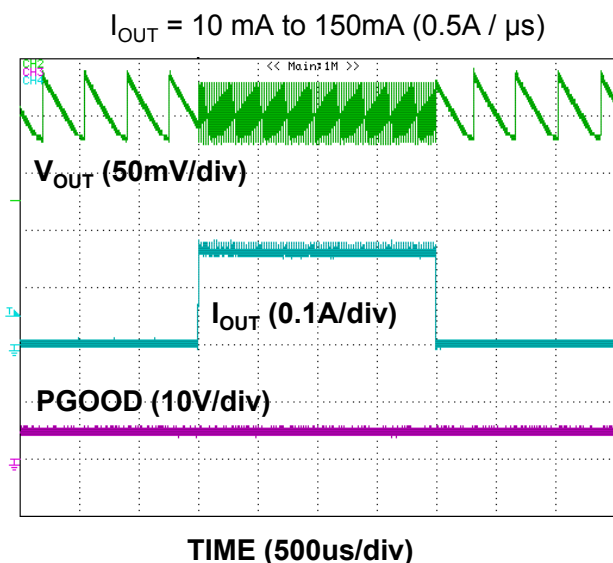

**TYPICAL CHARACTERISTICS CURVES (Continued)**

**2. Load transient response (Continued)**

Condition :  $V_{IN} = 12\text{ V}$ ,  $V_5 = 5\text{ V}$ ,  $V_{OUT}$  Setting =  $1.05\text{ V}$ , Switching Frequency =  $630\text{ kHz}$ , Normal Mode,  
 $L_O = 1\text{ }\mu\text{H}$ ,  $C_O = 88\text{ }\mu\text{F}$  ( $22\text{ }\mu\text{F} \times 4$ )

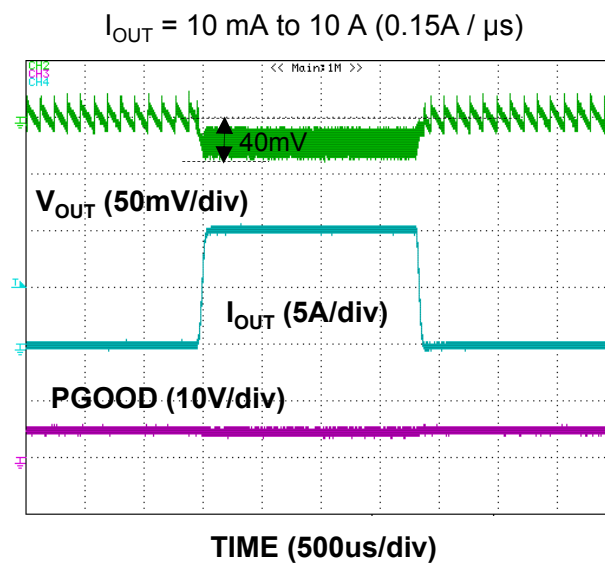
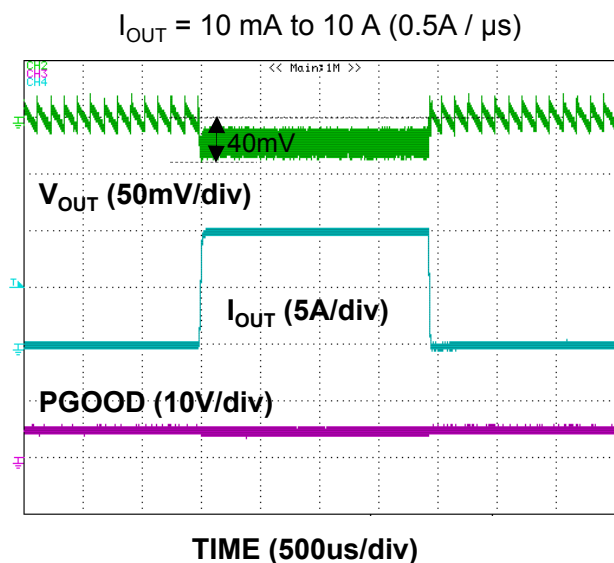

Condition :  $V_{IN} = 12\text{ V}$ ,  $V_5 = 5\text{ V}$ ,  $V_{OUT}$  Setting =  $1.05\text{ V}$ , Switching Frequency =  $630\text{ kHz}$ , Low Power Mode,  
 $L_O = 1\text{ }\mu\text{H}$ ,  $C_O = 88\text{ }\mu\text{F}$  ( $22\text{ }\mu\text{F} \times 4$ )

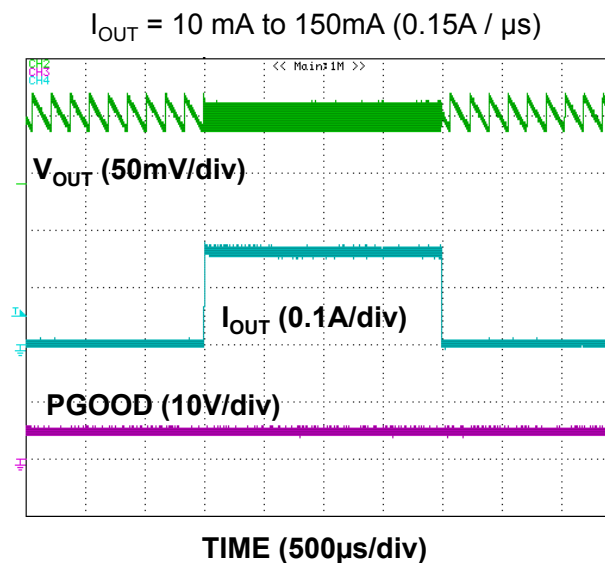
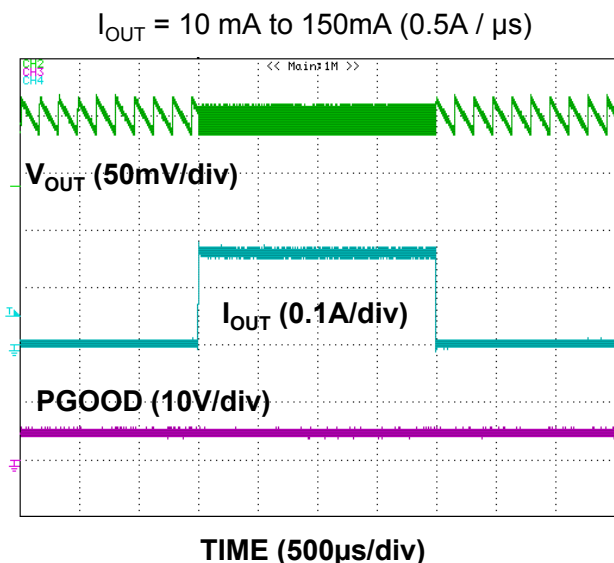

**TYPICAL CHARACTERISTICS CURVES (Continued)**

**3. Efficiency**

Condition :  $V_{IN} = 7.4\text{ V} / 12\text{ V} / 19\text{ V}$ ,  $V_5 = 5\text{ V}$ , Switching Frequency = 430 kHz, Normal Mode,  
 $C_O = 88\text{ }\mu\text{F}$  (22  $\mu\text{F}$  x 4) #Including  $V_5$  current

$V_{OUT} = 1.05\text{ V}$ ,  $L_o = 1\text{ }\mu\text{H}$

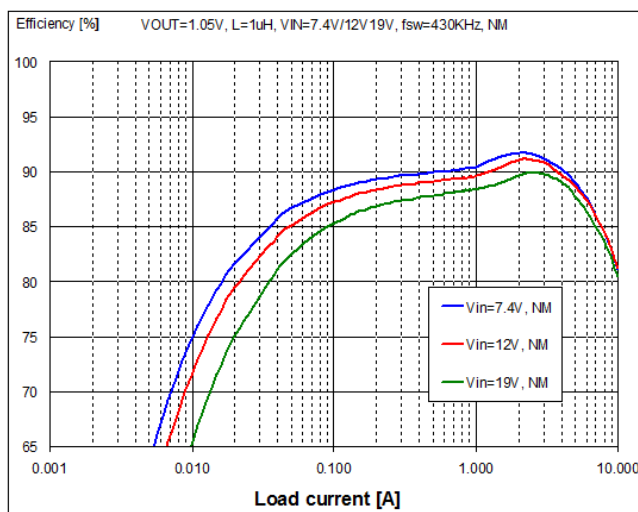

$V_{OUT} = 1.2\text{ V}$ ,  $L_o = 1\text{ }\mu\text{H}$

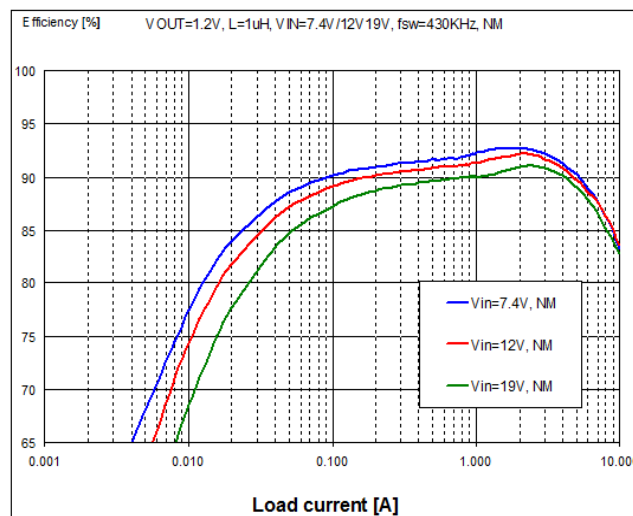

$V_{OUT} = 1.8\text{ V}$ ,  $L_o = 1\text{ }\mu\text{H}$

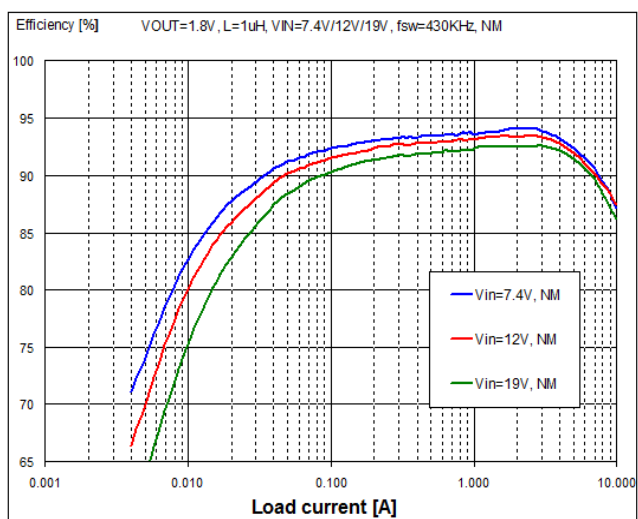

$V_{OUT} = 3.3\text{ V}$ ,  $L_o = 3.3\text{ }\mu\text{H}$

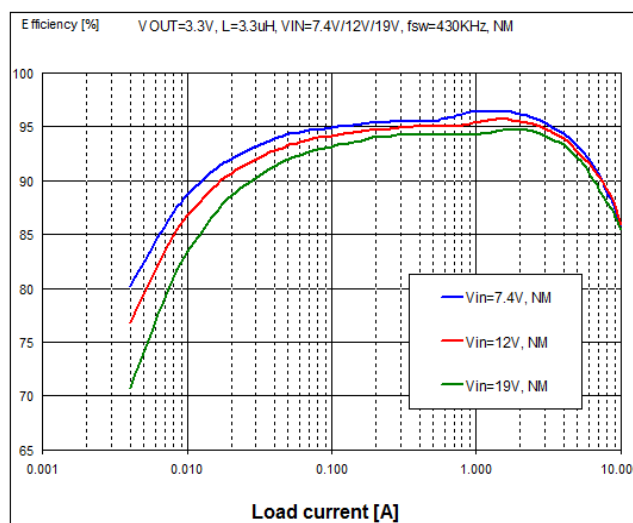

**TYPICAL CHARACTERISTICS CURVES (Continued)**

**3. Efficiency (Continued)**

Condition :  $V_{IN} = 7.4 \text{ V} / 12 \text{ V} / 19 \text{ V}$ ,  $V_5 = 5 \text{ V}$ , Switching Frequency = 430 kHz, Low Power Mode,  
 $C_O = 88 \mu\text{F}$  (22  $\mu\text{F} \times 4$ ) #Including  $V_5$  current

$V_{OUT} = 1.05 \text{ V}$ ,  $L_o = 1 \mu\text{H}$

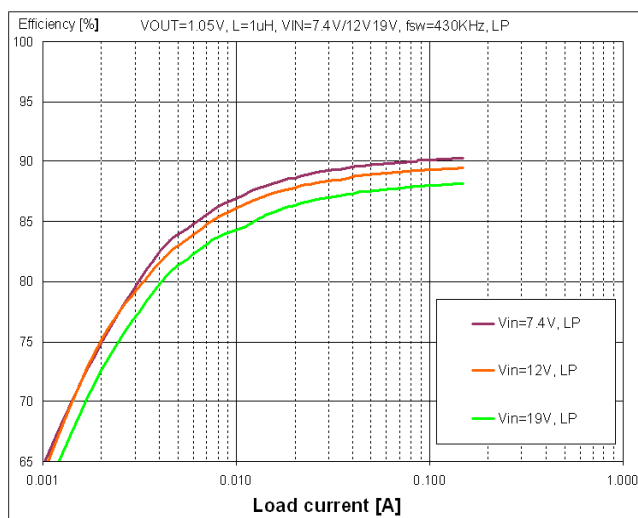

$V_{OUT} = 1.2 \text{ V}$ ,  $L_o = 1 \mu\text{H}$

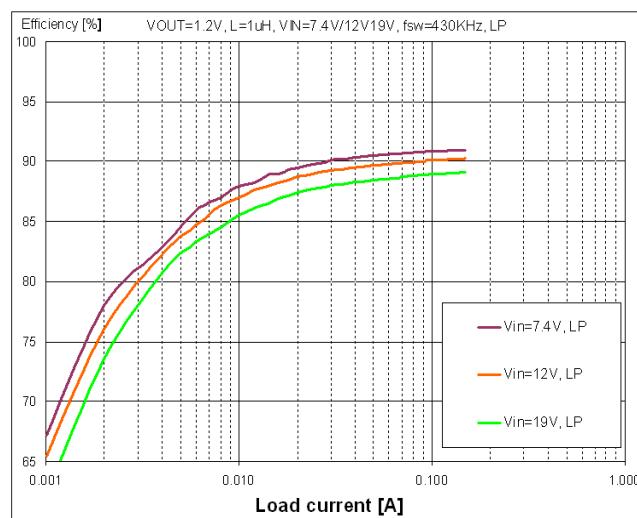

$V_{OUT} = 1.8 \text{ V}$ ,  $L_o = 1 \mu\text{H}$

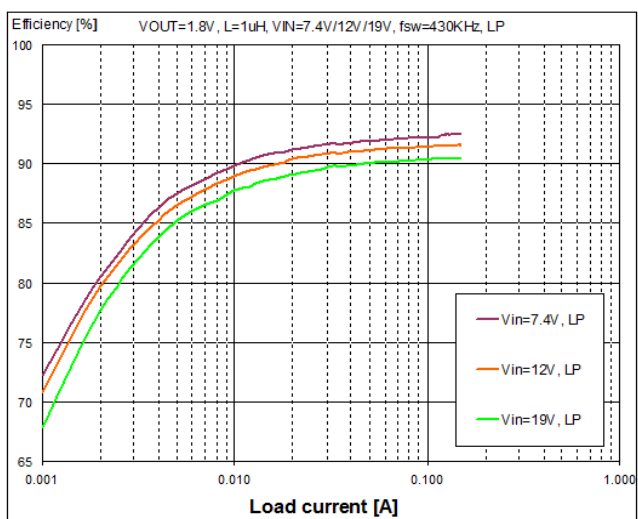

$V_{OUT} = 3.3 \text{ V}$ ,  $L_o = 3.3 \mu\text{H}$

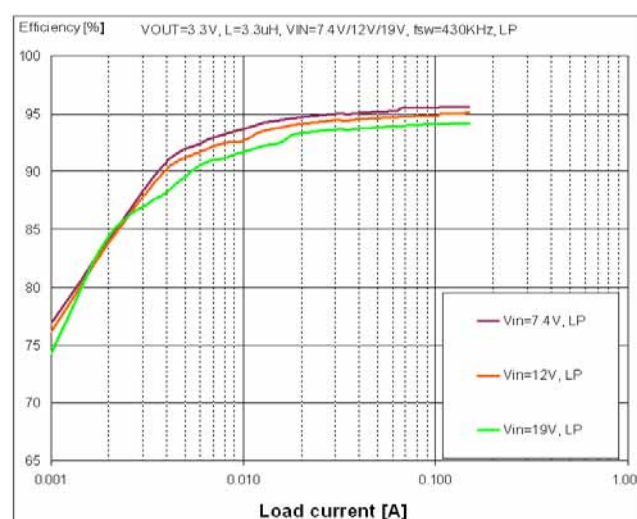

**TYPICAL CHARACTERISTICS CURVES (Continued)**

**3. Efficiency (Continued)**

Condition :  $V_{IN} = 7.4\text{ V} / 12\text{ V} / 19\text{ V}$ ,  $V_5 = 5\text{ V}$ , Switching Frequency = 630 kHz, Normal Mode,  
 $C_O = 88\text{ }\mu\text{F}$  (22  $\mu\text{F}$  x 4) #Including  $V_5$  current

$V_{OUT} = 1.05\text{ V}$ ,  $L_o = 1\text{ }\mu\text{H}$

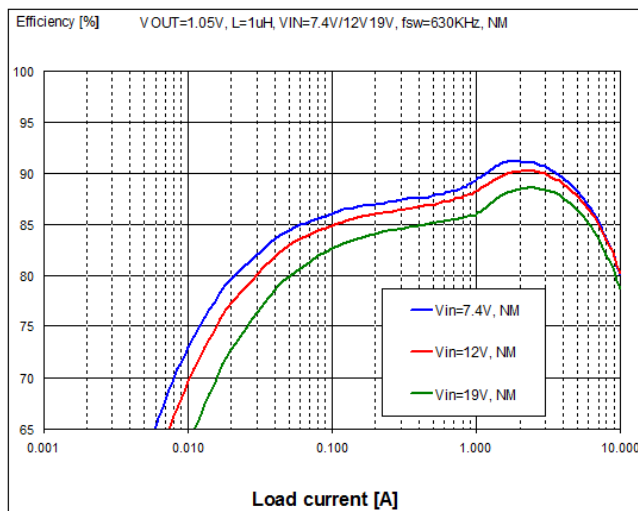

$V_{OUT} = 1.2\text{ V}$ ,  $L_o = 1\text{ }\mu\text{H}$

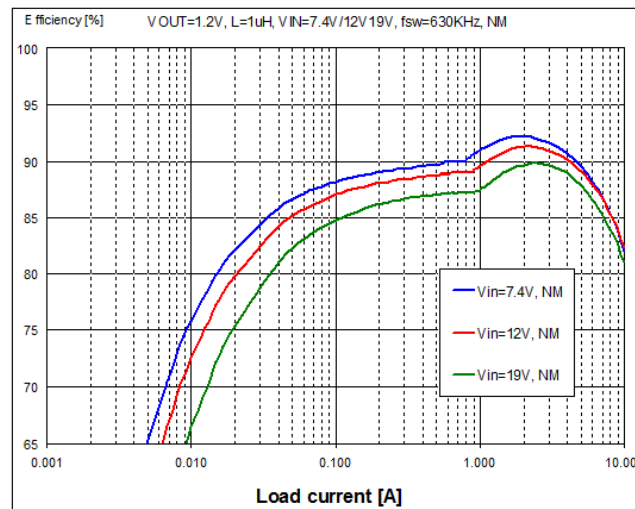

$V_{OUT} = 1.8\text{ V}$ ,  $L_o = 1\text{ }\mu\text{H}$

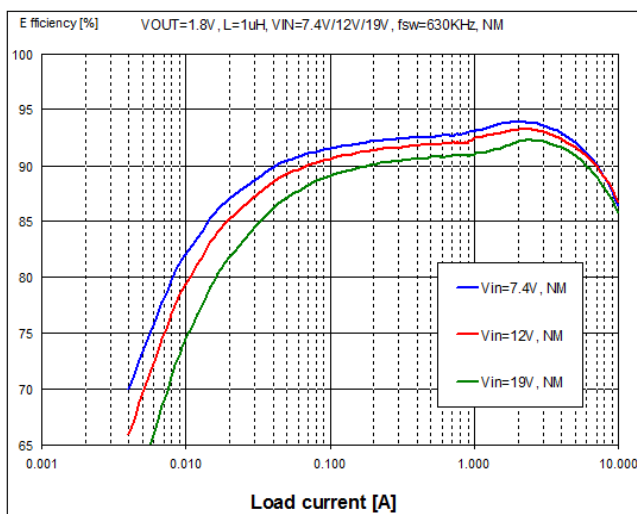

$V_{OUT} = 3.3\text{ V}$ ,  $L_o = 3.3\text{ }\mu\text{H}$

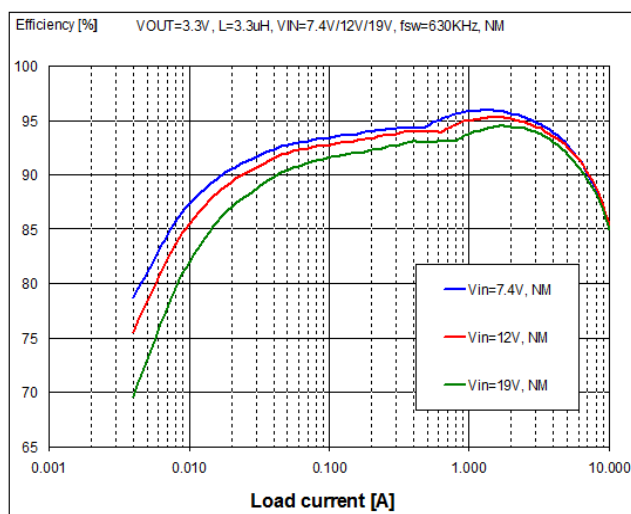

**TYPICAL CHARACTERISTICS CURVES (Continued)**

**3. Efficiency (Continued)**

Condition :  $V_{IN} = 7.4\text{ V} / 12\text{ V} / 19\text{ V}$ ,  $V_5 = 5\text{ V}$ , Switching Frequency = 630 kHz, Low Power Mode,  
 $C_O = 88\text{ }\mu\text{F}$  (22  $\mu\text{F}$  x 4) #Including  $V_5$  current

$V_{OUT} = 1.05\text{ V}$ ,  $L_o = 1\text{ }\mu\text{H}$

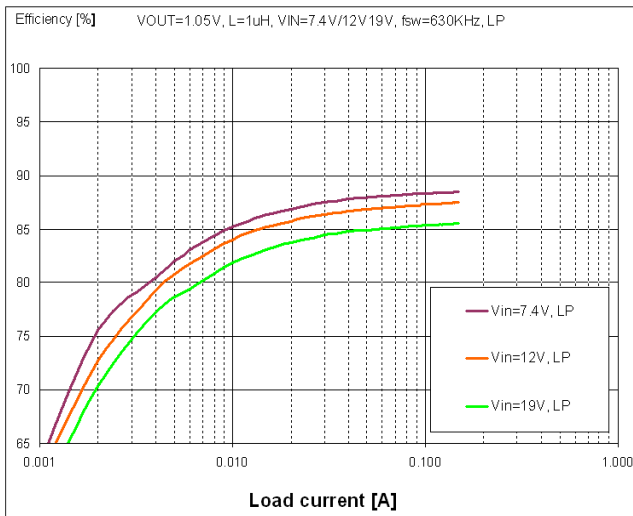

$V_{OUT} = 1.2\text{ V}$ ,  $L_o = 1\text{ }\mu\text{H}$

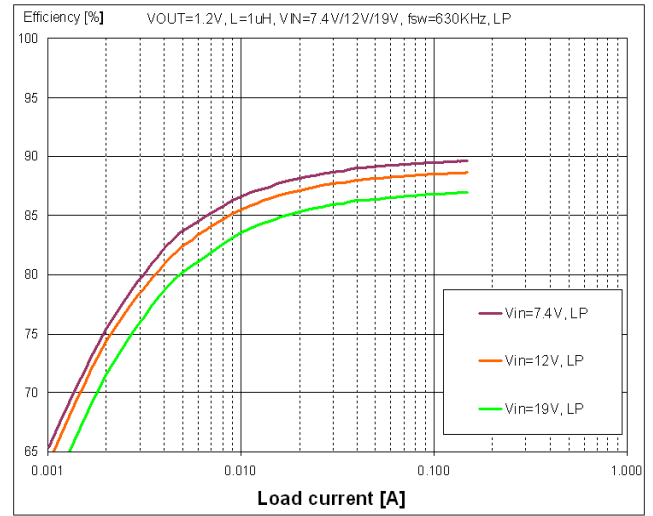

$V_{OUT} = 1.8\text{ V}$ ,  $L_o = 1\text{ }\mu\text{H}$

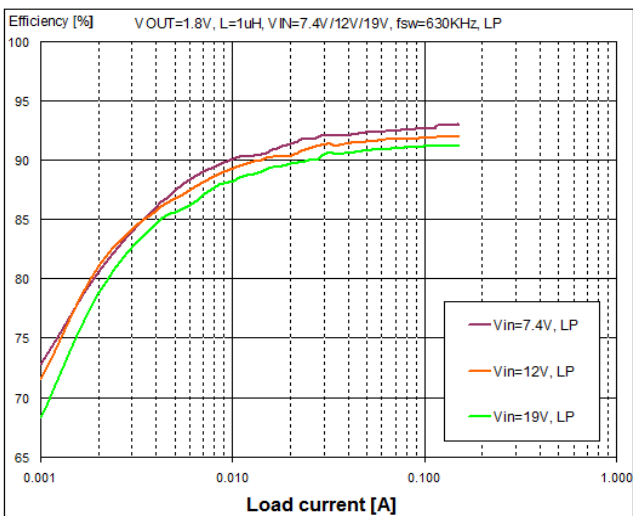

$V_{OUT} = 3.3\text{ V}$ ,  $L_o = 3.3\text{ }\mu\text{H}$

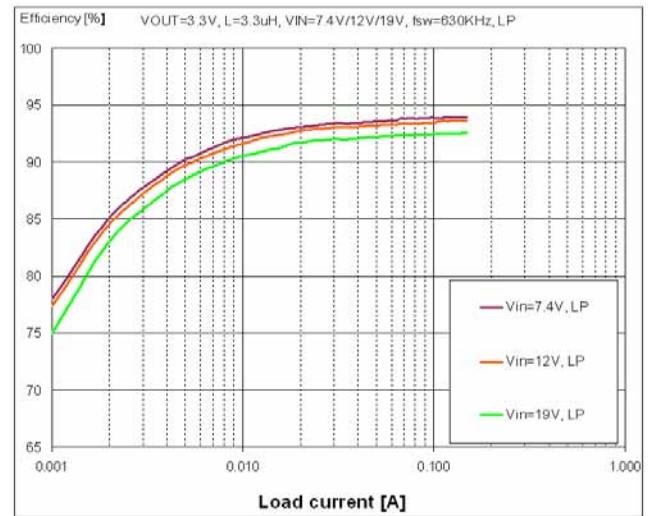

TYPICAL CHARACTERISTICS CURVES (Continued)

4. Load Regulation

Condition :  $V_{IN} = 12\text{ V}$ ,  $V_5 = 5\text{ V}$ ,  $V_{OUT}$  Setting = 1.05 V, Normal Mode,  $L_O = 1\ \mu\text{H}$ ,  $C_O = 88\ \mu\text{F}$  (22  $\mu\text{F} \times 4$ )

Frequency = 430 kHz

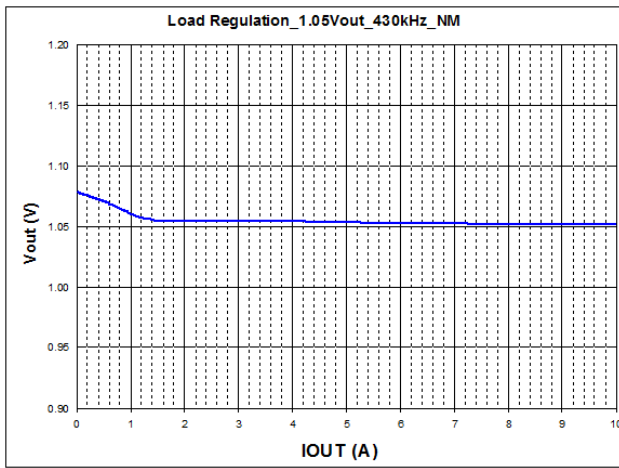

Frequency = 630 kHz

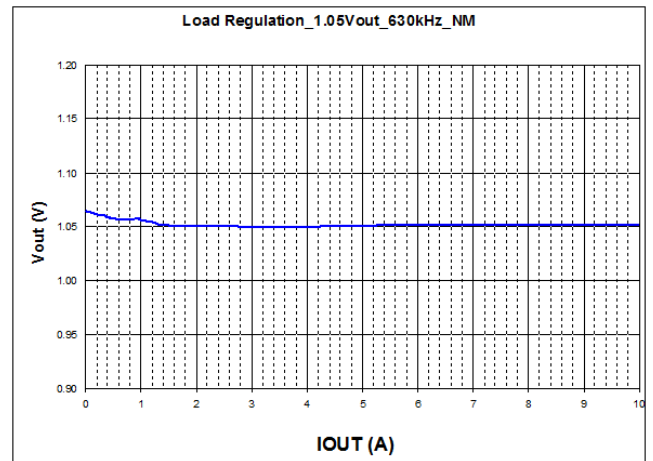

Condition :  $V_{IN} = 12\text{ V}$ ,  $V_5 = 5\text{ V}$ ,  $V_{OUT}$  Setting = 1.05 V, Low Power Mode,  $L_O = 1\ \mu\text{H}$ ,  $C_O = 88\ \mu\text{F}$  (22  $\mu\text{F} \times 4$ )

Frequency = 430 kHz

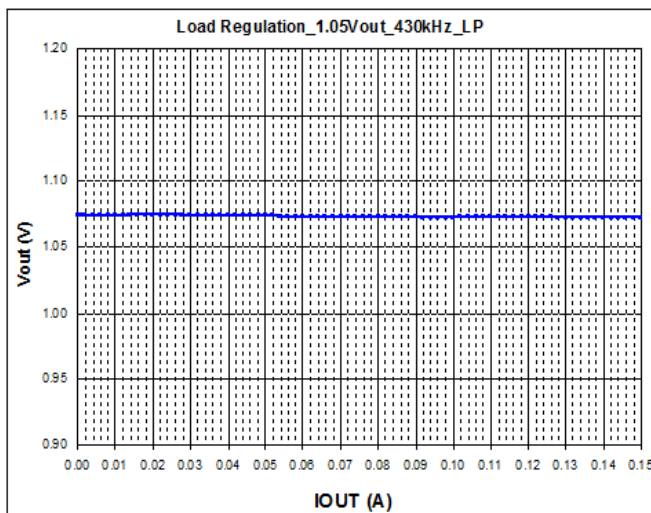

Frequency = 630 kHz

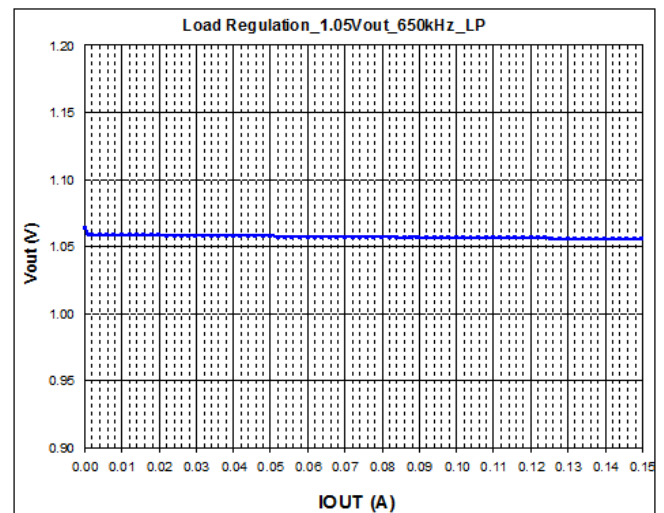

**TYPICAL CHARACTERISTICS CURVES (Continued)**

**5. Line Regulation**

Condition :  $V_5 = 5\text{ V}$ ,  $V_{\text{OUT}}$  Setting = 1.05 V, Normal Mode,  $I_{\text{OUT}} = 5\text{ A}$ ,  $L_O = 1\text{ }\mu\text{H}$ ,  $C_O = 88\text{ }\mu\text{F}$  (22  $\mu\text{F}$  x 4)

Frequency = 430 kHz

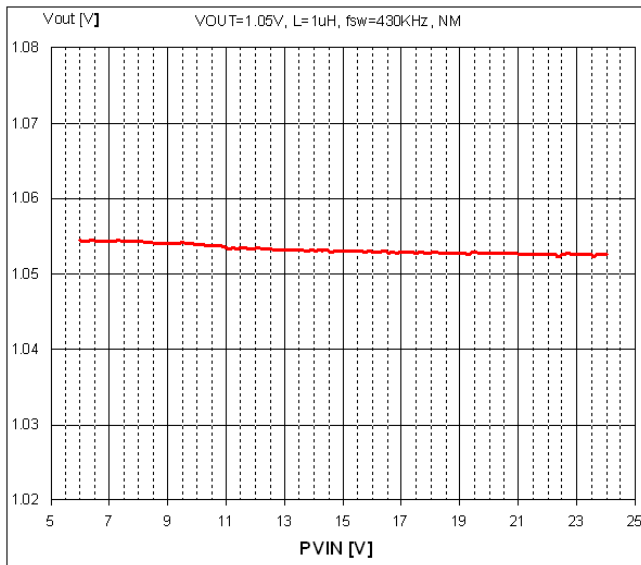

Frequency = 630 kHz

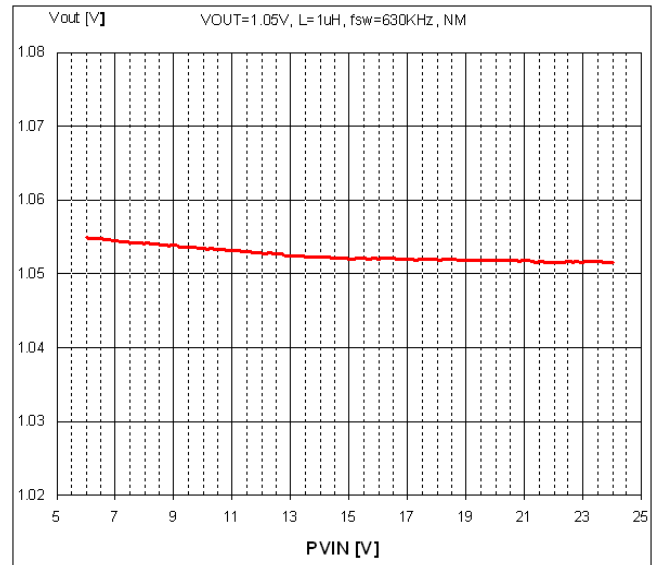

Condition :  $V_5 = 5\text{ V}$ ,  $V_{\text{OUT}}$  Setting = 1.05 V, Low Power Mode,  $I_{\text{OUT}} = 150\text{ mA}$ ,  $L_O = 1\text{ }\mu\text{H}$ ,  $C_O = 88\text{ }\mu\text{F}$  (22  $\mu\text{F}$  x 4)

Frequency = 430 kHz

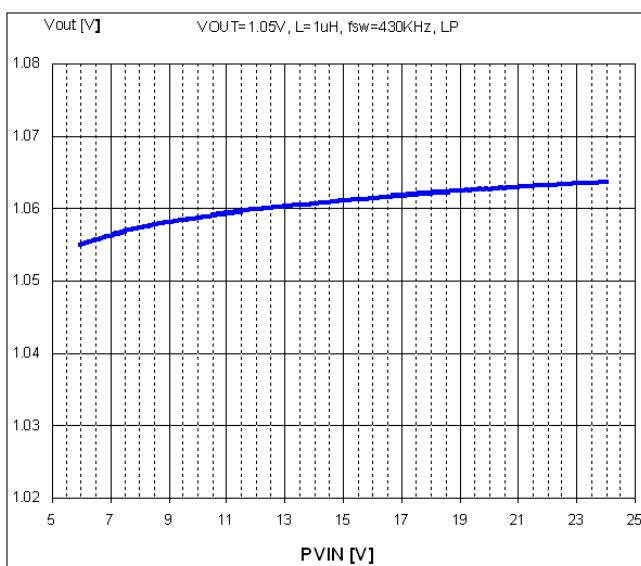

Frequency = 630 kHz

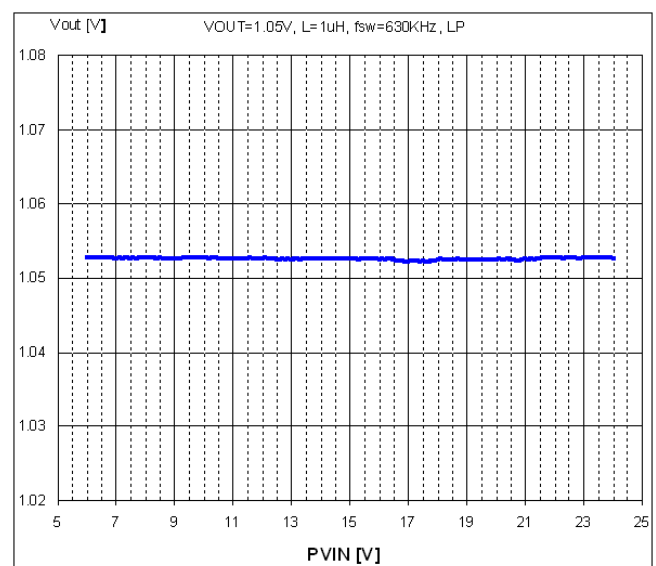

## TYPICAL CHARACTERISTICS CURVES (Continued)

### 6. Start / Shut Down

Condition :  $V_{IN} = 12\text{ V}$ ,  $V_S = 5\text{ V}$ ,  $V_{OUT}$  Setting = 1.05 V, Switching Frequency = 430 kHz, Normal Mode,  
 $I_{OUT} = 0\text{ A}$ ,  $L_O = 1\text{ }\mu\text{H}$ ,  $C_O = 88\text{ }\mu\text{F}$  (22  $\mu\text{F}$  x 4)

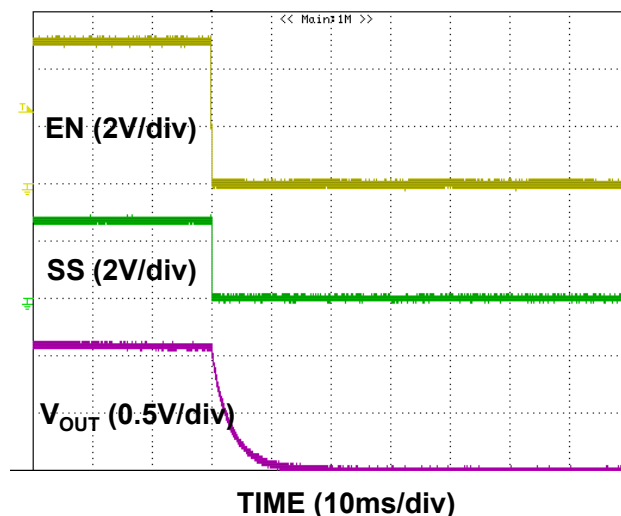
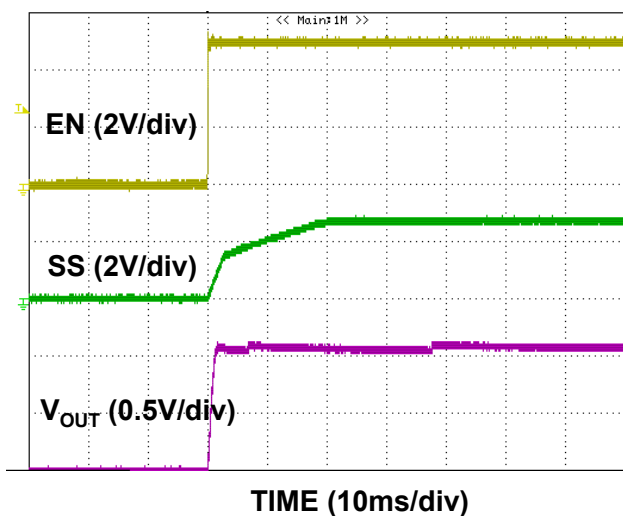

Condition :  $V_{IN} = 12\text{ V}$ ,  $V_S = 5\text{ V}$ ,  $V_{OUT}$  Setting = 1.05 V, Switching Frequency = 430 kHz, Low Power Mode,  
 $I_{OUT} = 0\text{ A}$ ,  $L_O = 1\text{ }\mu\text{H}$ ,  $C_O = 88\text{ }\mu\text{F}$  (22  $\mu\text{F}$  x 4)

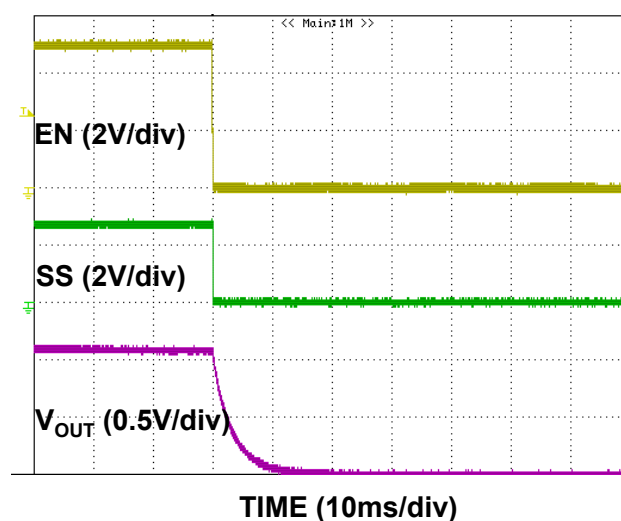
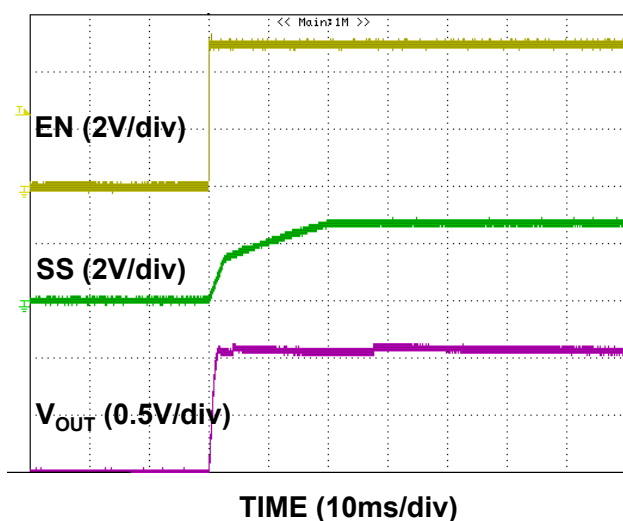

## TYPICAL CHARACTERISTICS CURVES (Continued)

### 6. Start / Shut Down (Continued)

Condition :  $V_{IN} = 12\text{ V}$ ,  $V_5 = 5\text{ V}$ ,  $V_{OUT}$  Setting = 1.05 V, Switching Frequency = 630 kHz, Normal Mode,  
 $I_{OUT} = 0\text{ A}$ ,  $L_O = 1\text{ }\mu\text{H}$ ,  $C_O = 88\text{ }\mu\text{F}$  (22  $\mu\text{F}$  x 4)

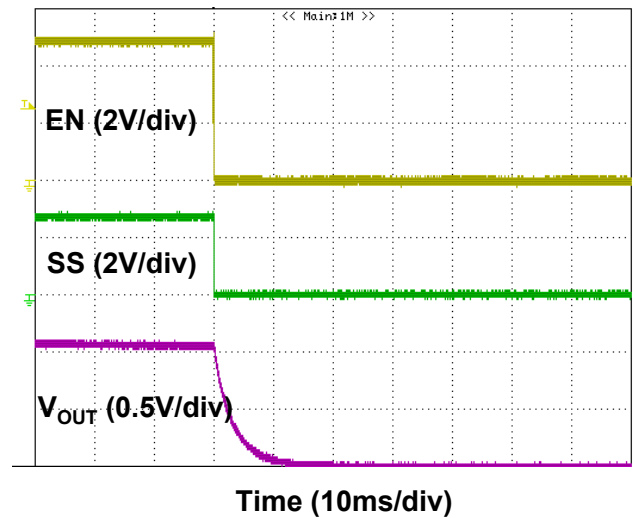
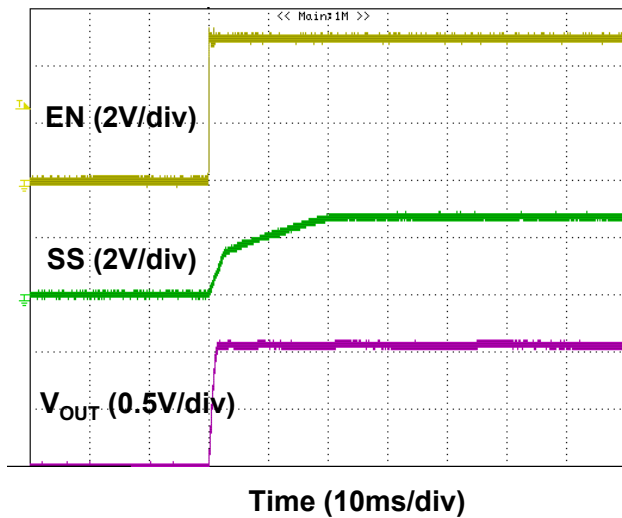

Condition :  $V_{IN} = 12\text{ V}$ ,  $V_5 = 5\text{ V}$ ,  $V_{OUT}$  Setting = 1.05 V, Switching Frequency = 630 kHz, Low Power Mode,  
 $I_{OUT} = 0\text{ A}$ ,  $L_O = 1\text{ }\mu\text{H}$ ,  $C_O = 88\text{ }\mu\text{F}$  (22  $\mu\text{F}$  x 4)

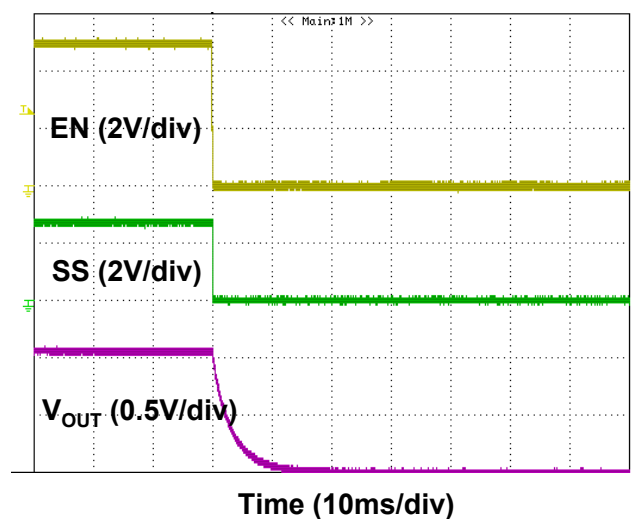
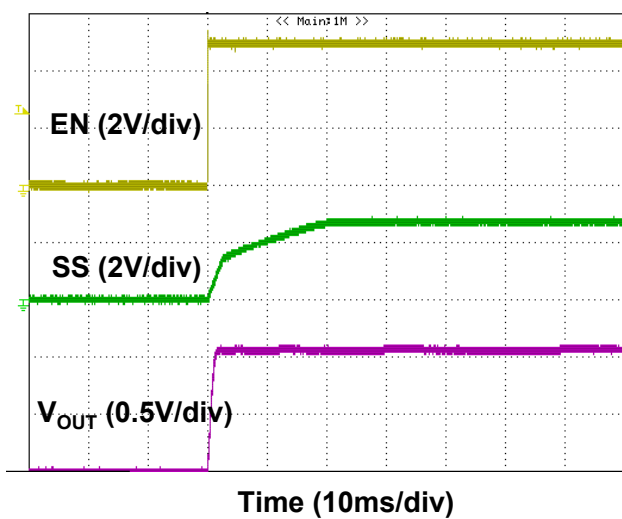

## TYPICAL CHARACTERISTICS CURVES (Continued)

### 6. Start / Shut Down (Continued)

Condition :  $V_{IN} = 12\text{ V}$ ,  $V_S = 5\text{ V}$ ,  $V_{OUT}$  Setting = 1.05 V (Built-in Feed Back Resistors),  
Switching Frequency = 430 kHz, Normal Mode,  $I_{OUT} = 0\text{ A}$ ,  $L_O = 1\text{ }\mu\text{H}$ ,  $C_O = 88\text{ }\mu\text{F}$  (22  $\mu\text{F}$  x 4)

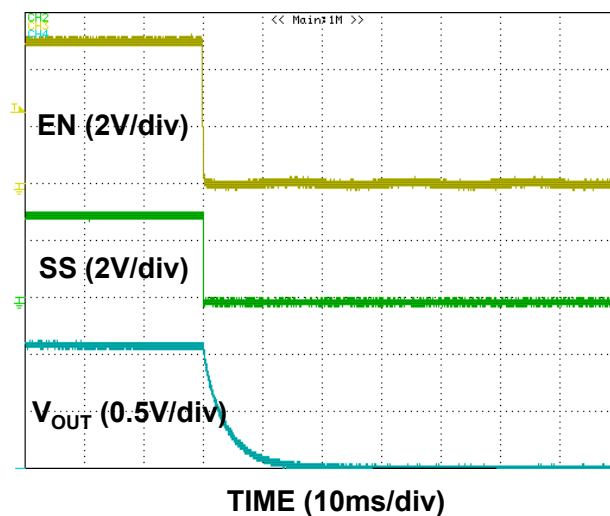
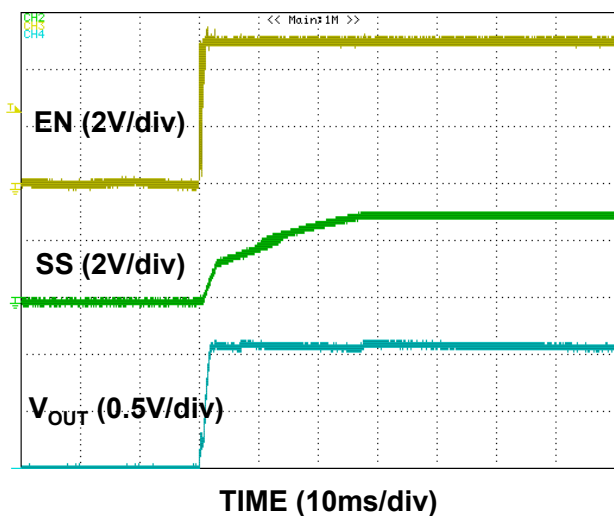

Condition :  $V_{IN} = 12\text{ V}$ ,  $V_S = 5\text{ V}$ ,  $V_{OUT}$  Setting = 1.05 V (Built-in Feed Back Resistors),  
Switching Frequency = 430 kHz, Low Power Mode,  $I_{OUT} = 0\text{ A}$ ,  $L_O = 1\text{ }\mu\text{H}$ ,  $C_O = 88\text{ }\mu\text{F}$  (22  $\mu\text{F}$  x 4)

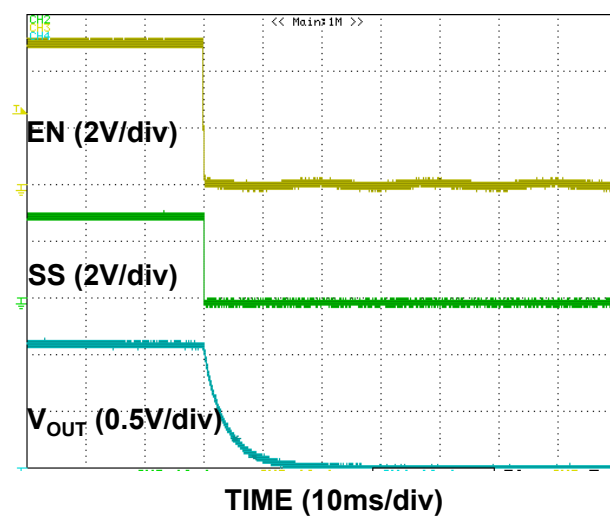
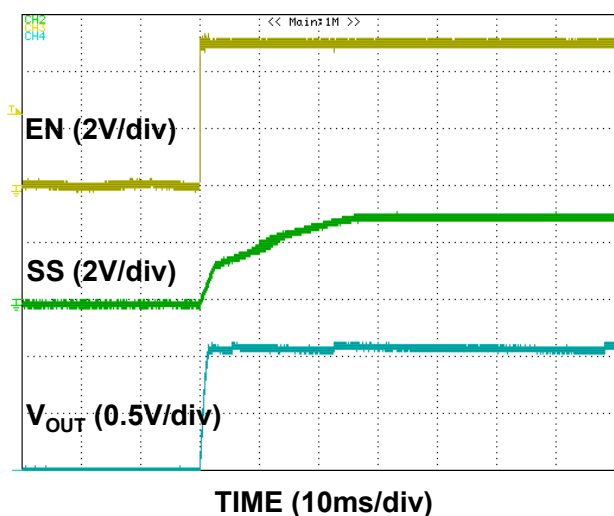

## TYPICAL CHARACTERISTICS CURVES (Continued)

### 6. Start / Shut Down (Continued)

Condition :  $V_{IN} = 12\text{ V}$ ,  $V_5 = 5\text{ V}$ ,  $V_{OUT}$  Setting = 1.05 V (Built-in Feed Back Resistors),  
Switching Frequency = 630 kHz, Normal Mode,  $I_{OUT} = 0\text{ A}$ ,  $L_O = 1\text{ }\mu\text{H}$ ,  $C_O = 88\text{ }\mu\text{F}$  (22  $\mu\text{F}$  x 4)

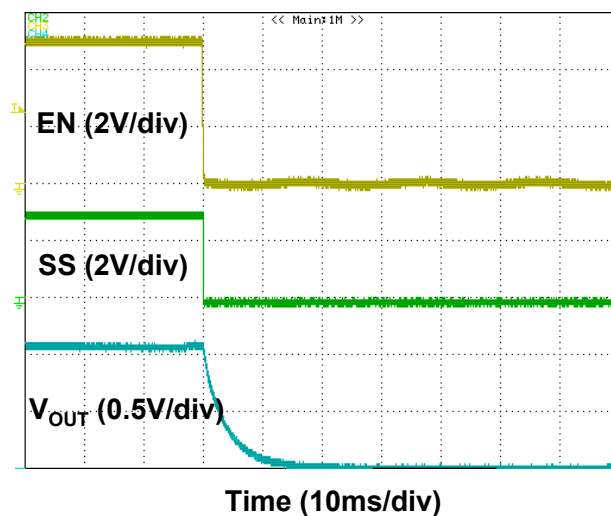
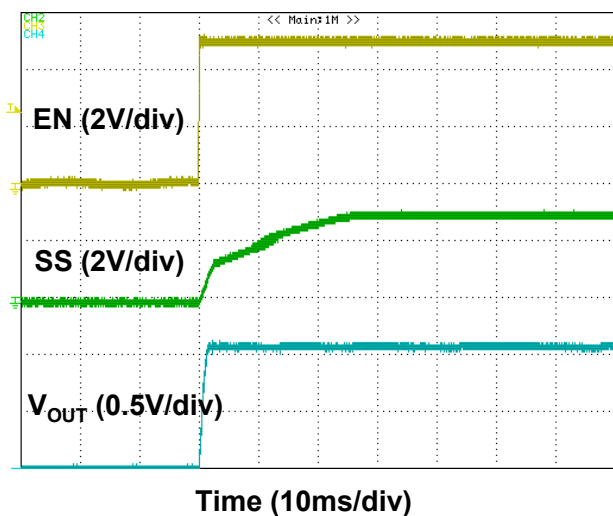

Condition :  $V_{IN} = 12\text{ V}$ ,  $V_5 = 5\text{ V}$ ,  $V_{OUT}$  Setting = 1.05 V (Built-in Feed Back Resistors),  
Switching Frequency = 630 kHz, Low Power Mode,  $I_{OUT} = 0\text{ A}$ ,  $L_O = 1\text{ }\mu\text{H}$ ,  $C_O = 88\text{ }\mu\text{F}$  (22  $\mu\text{F}$  x 4)

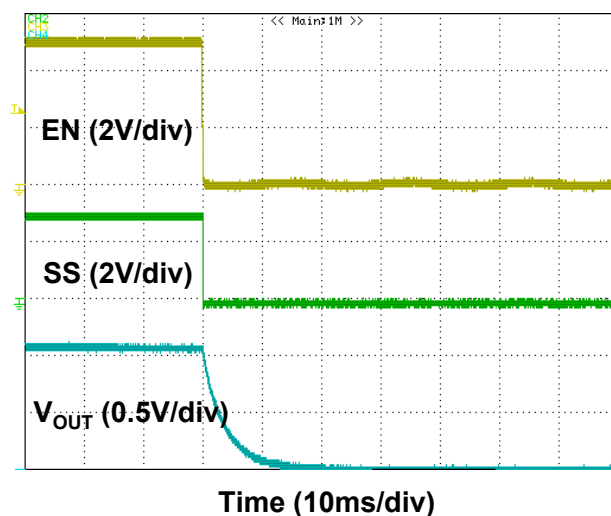
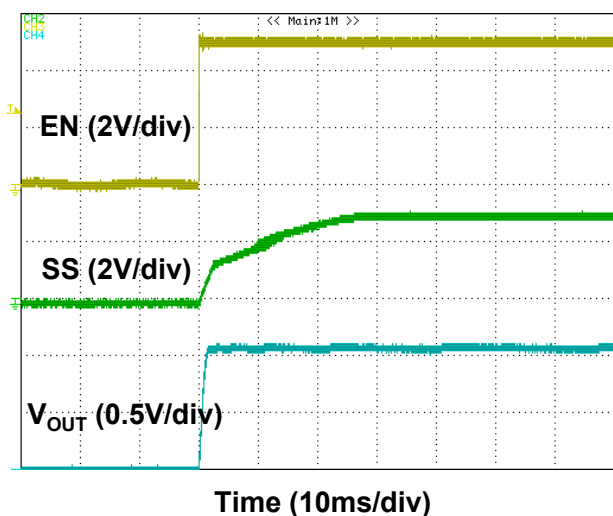

## TYPICAL CHARACTERISTICS CURVES (Continued)

### 6. Start / Shut Down (Continued)

Condition :  $V_{IN} = 12\text{ V}$ ,  $V_5 = 5\text{ V}$ ,  $V_{OUT}$  Setting =  $1.2\text{ V}$  (Built-in Feed Back Resistors),  
Switching Frequency =  $430\text{ kHz}$ , Normal Mode,  $I_{OUT} = 0\text{ A}$ ,  $L_O = 1\text{ }\mu\text{H}$ ,  $C_O = 88\text{ }\mu\text{F}$  ( $22\text{ }\mu\text{F} \times 4$ )

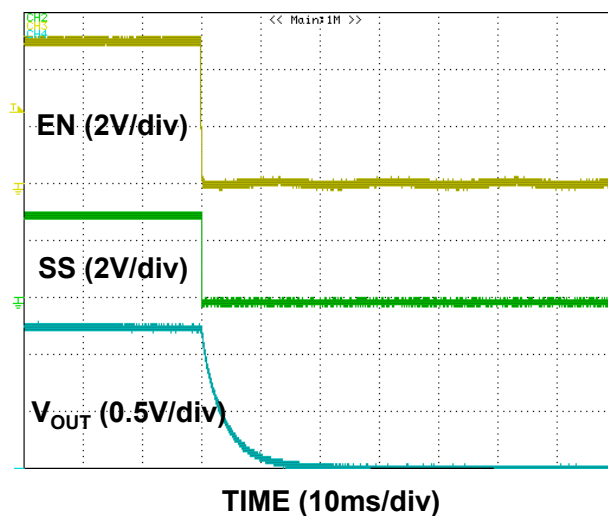
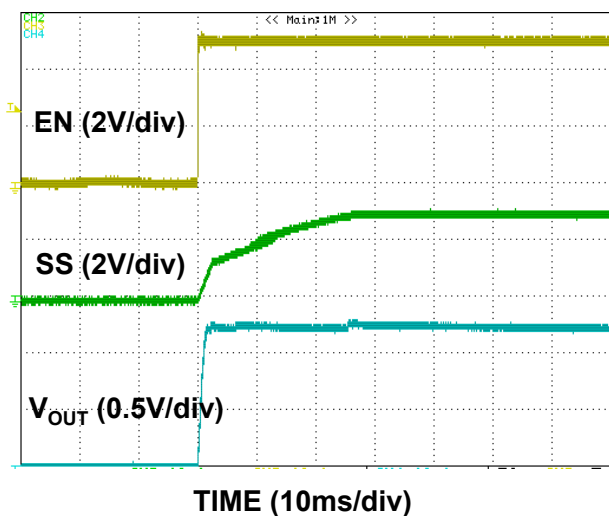

Condition :  $V_{IN} = 12\text{ V}$ ,  $V_5 = 5\text{ V}$ ,  $V_{OUT}$  Setting =  $1.2\text{ V}$  (Built-in Feed Back Resistors),  
Switching Frequency =  $430\text{ kHz}$ , Low Power Mode,  $I_{OUT} = 0\text{ A}$ ,  $L_O = 1\text{ }\mu\text{H}$ ,  $C_O = 88\text{ }\mu\text{F}$  ( $22\text{ }\mu\text{F} \times 4$ )

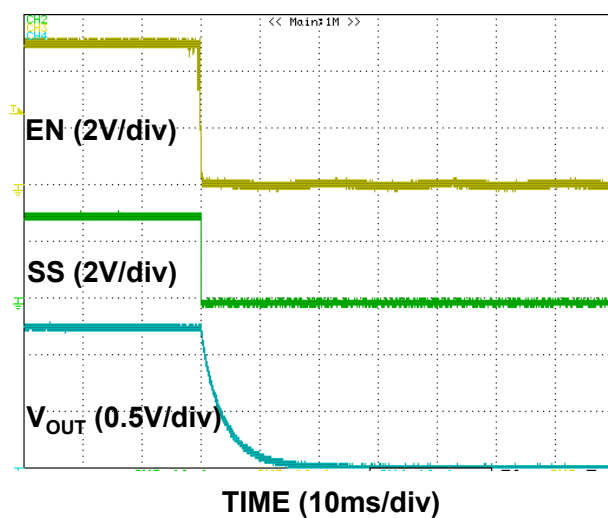
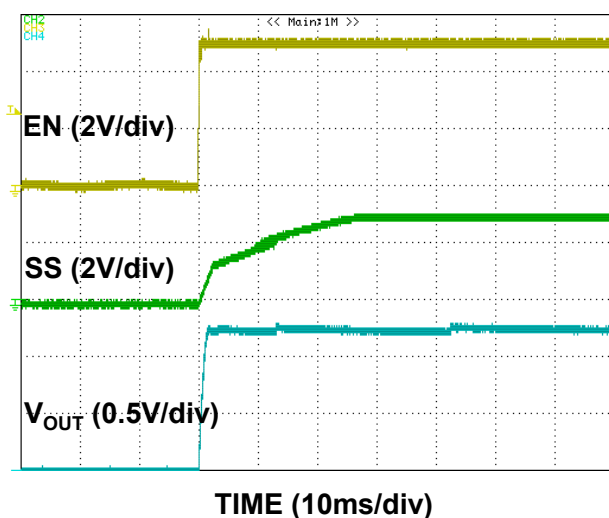

## TYPICAL CHARACTERISTICS CURVES (Continued)

### 6. Start / Shut Down (Continued)

Condition :  $V_{IN} = 12\text{ V}$ ,  $V_5 = 5\text{ V}$ ,  $V_{OUT}$  Setting =  $1.2\text{ V}$  (Built-in Feed Back Resistors),  
Switching Frequency =  $630\text{ kHz}$ , Normal Mode,  $I_{OUT} = 0\text{ A}$ ,  $L_O = 1\text{ }\mu\text{H}$ ,  $C_O = 88\text{ }\mu\text{F}$  ( $22\text{ }\mu\text{F} \times 4$ )

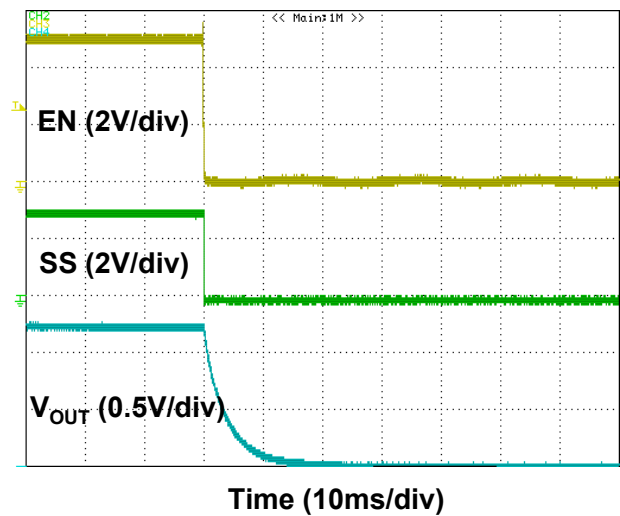
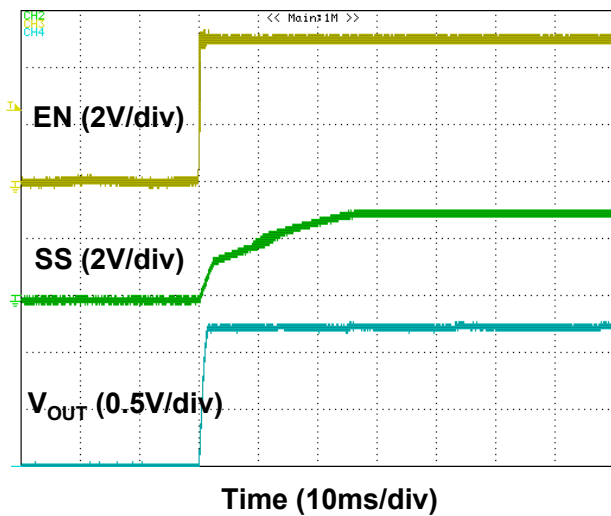

Condition :  $V_{IN} = 12\text{ V}$ ,  $V_5 = 5\text{ V}$ ,  $V_{OUT}$  Setting =  $1.2\text{ V}$  (Built-in Feed Back Resistors),  
Switching Frequency =  $630\text{ kHz}$ , Low Power Mode,  $I_{OUT} = 0\text{ A}$ ,  $L_O = 1\text{ }\mu\text{H}$ ,  $C_O = 88\text{ }\mu\text{F}$  ( $22\text{ }\mu\text{F} \times 4$ )

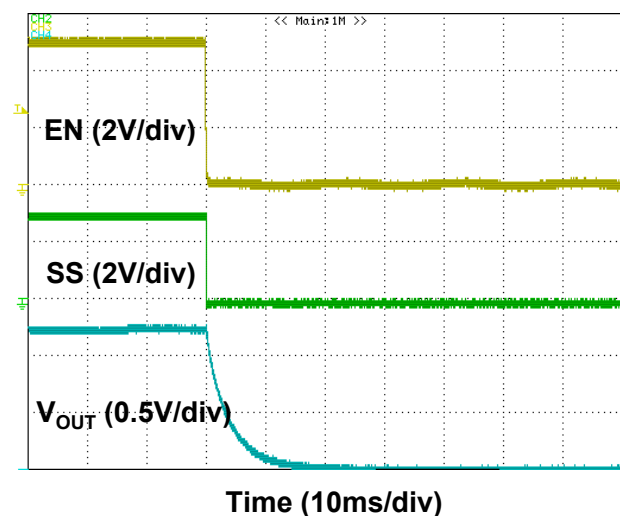
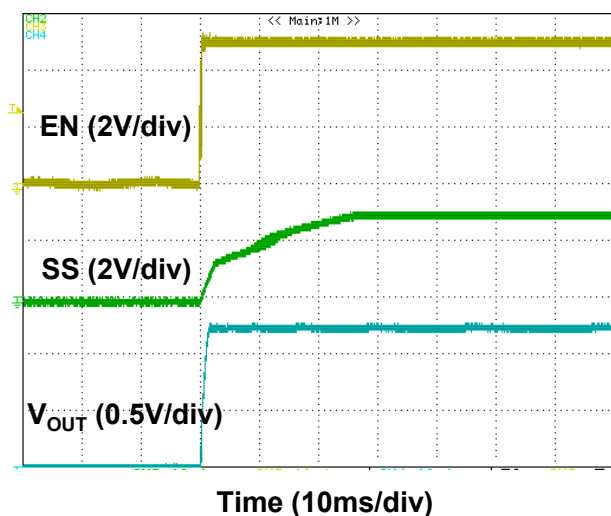

**TYPICAL CHARACTERISTICS CURVES (Continued)**

**7. Short Circuit Protection**

Condition :  $V_{IN} = 12\text{ V}$ ,  $V_5 = 5\text{ V}$ ,  $V_{OUT}$  Setting = 1.05 V, Switching Frequency = 430 kHz,  
 $L_O = 1\text{ }\mu\text{H}$ ,  $C_O = 88\text{ }\mu\text{F}$  (22  $\mu\text{F}$  x 4)

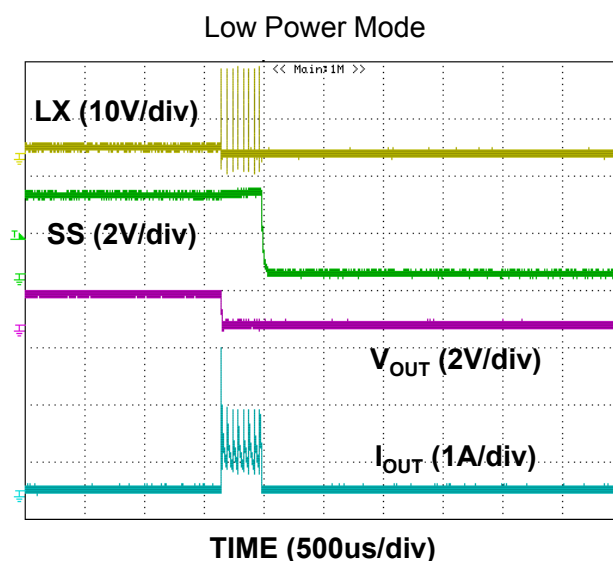
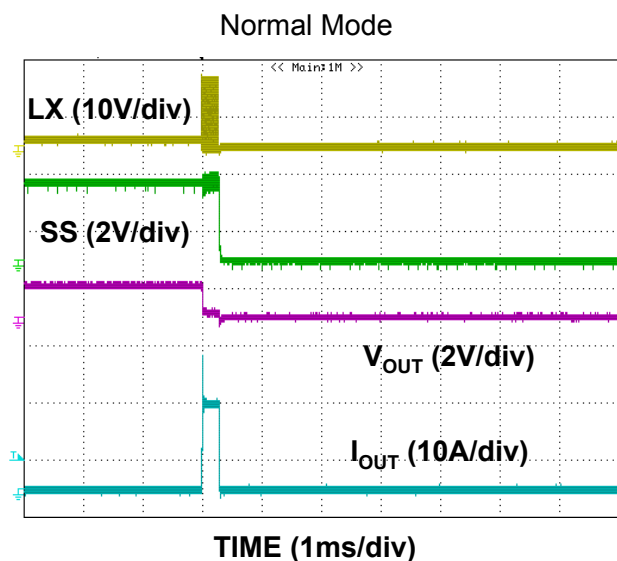

Condition :  $V_{IN} = 12\text{ V}$ ,  $V_5 = 5\text{ V}$ ,  $V_{OUT}$  Setting = 1.05 V, Switching Frequency = 630 kHz,  
 $L_O = 1\text{ }\mu\text{H}$ ,  $C_O = 88\text{ }\mu\text{F}$  (22  $\mu\text{F}$  x 4)

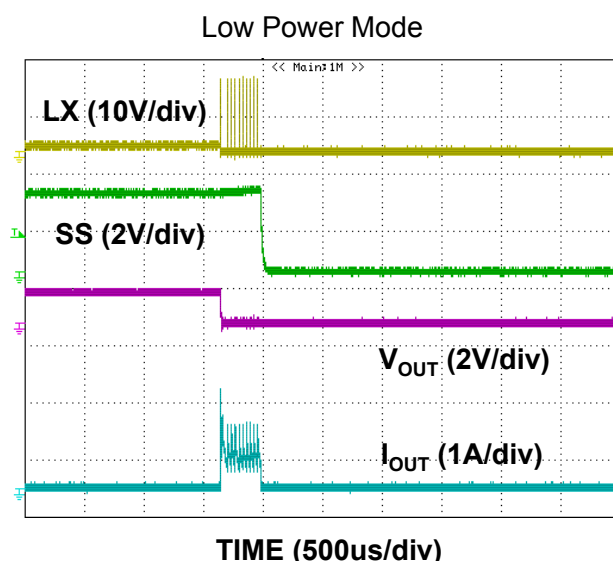
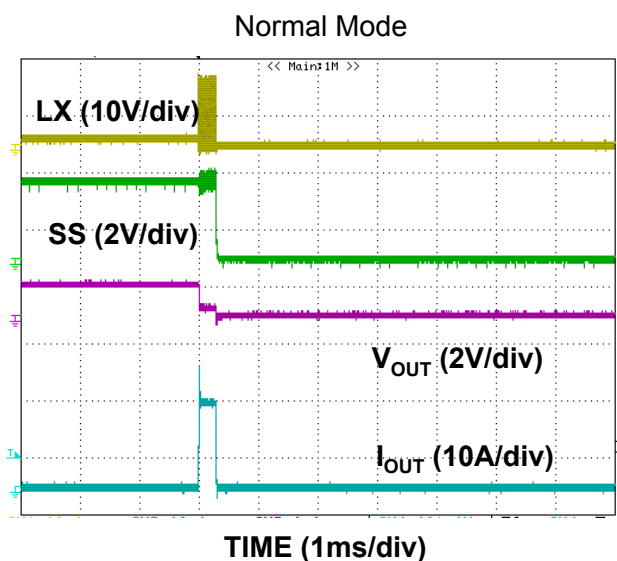

**TYPICAL CHARACTERISTICS CURVES (Continued)**

**8. Switching Frequency**

Condition :  $V_{IN} = 12\text{ V}$ ,  $V_5 = 5\text{ V}$ ,  $V_{OUT}$  Setting =  $1.05\text{ V}$ ,  $I_{OUT} = 10\text{ mA}$  to  $10\text{ A}$ ,  
 $L_O = 1\text{ }\mu\text{H}$ ,  $C_O = 88\text{ }\mu\text{F}$  ( $22\text{ }\mu\text{F} \times 4$ )

Frequency = 430 kHz

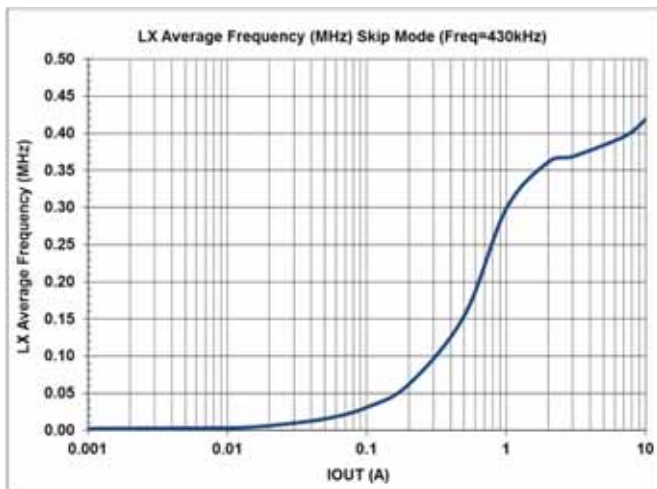

Frequency = 630 kHz

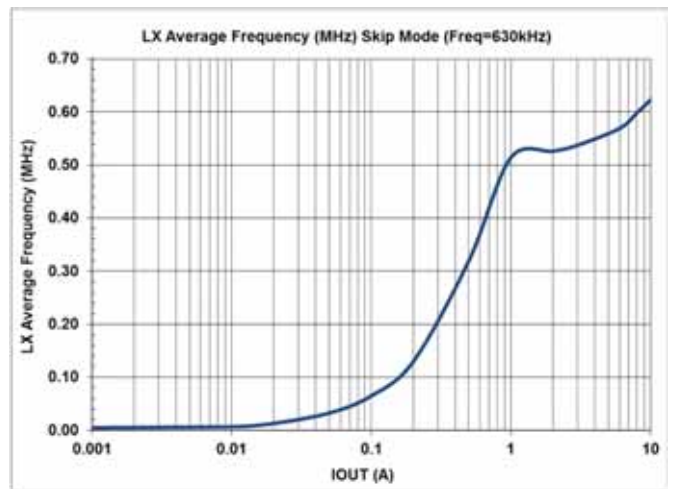

Condition :  $V_5 = 5\text{ V}$ ,  $V_{OUT}$  Setting =  $1.05\text{ V}$ ,  $I_{OUT} = 10\text{ A}$ ,  $V_{IN} = 4.5\text{ V}$  to  $24\text{ V}$ ,  
 $L_O = 1\text{ }\mu\text{H}$ ,  $C_O = 88\text{ }\mu\text{F}$  ( $22\text{ }\mu\text{F} \times 4$ )

Frequency = 430 kHz

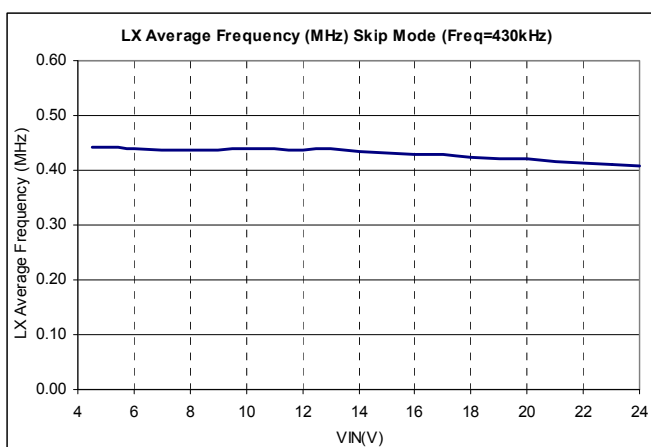

Frequency = 630 kHz

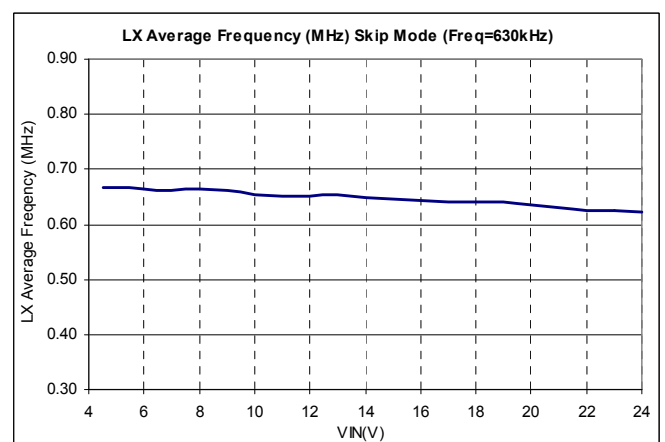

## TYPICAL CHARACTERISTICS CURVES (Continued)

### 9. Thermal Performance

Condition :  $V_{IN} = 12\text{ V}$ ,  $V_S = 5\text{ V}$ ,  $V_{OUT}$  Setting = 1.05 V, Switching Frequency = 430 kHz, Normal Mode,  
 $I_{OUT} = 10\text{ A}$ ,  $L_O = 1\text{ }\mu\text{H}$ ,  $C_O = 88\text{ }\mu\text{F}$  (22  $\mu\text{F}$  x 4)

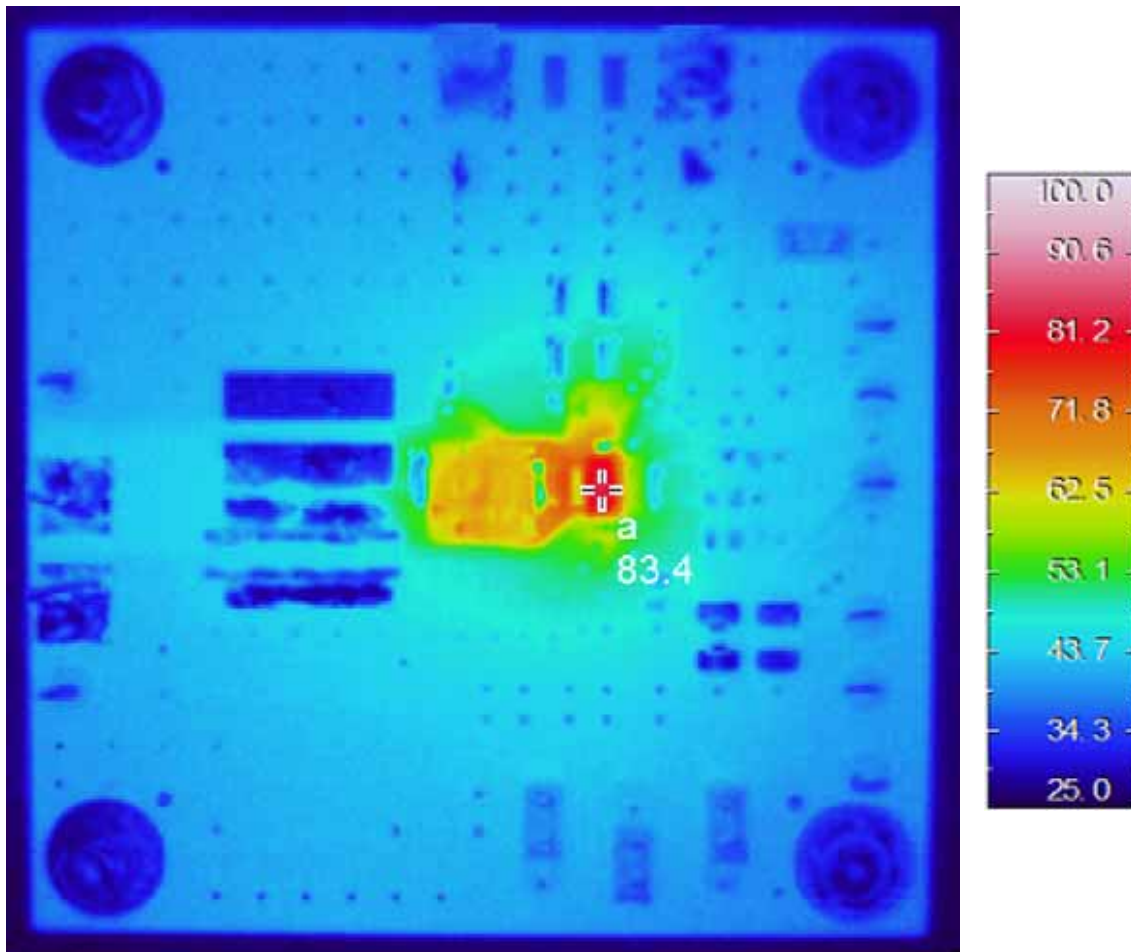

**APPLICATIONS INFORMATION**

**1. Evaluation Board Information**

Condition :  $V_{OUT}$  Setting = 1.05 V, Switching Frequency = 430 kHz, Low Power Mode

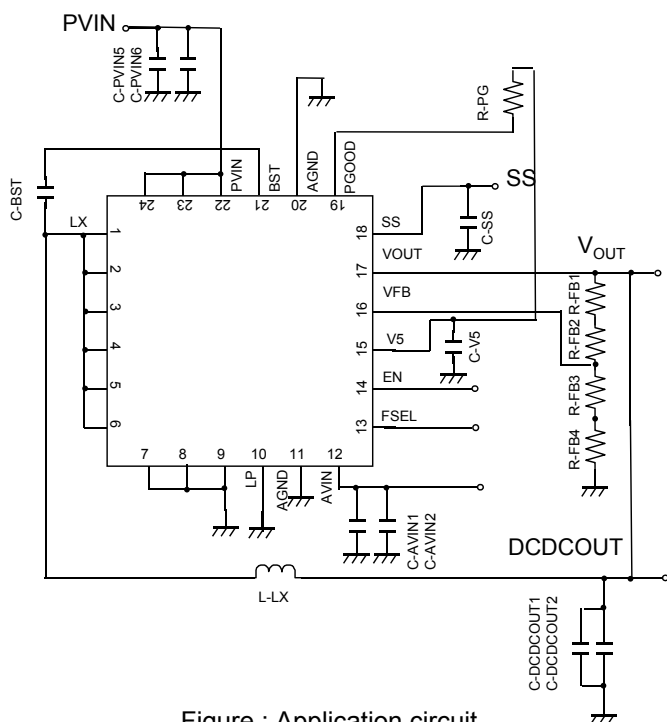

Figure : Application circuit

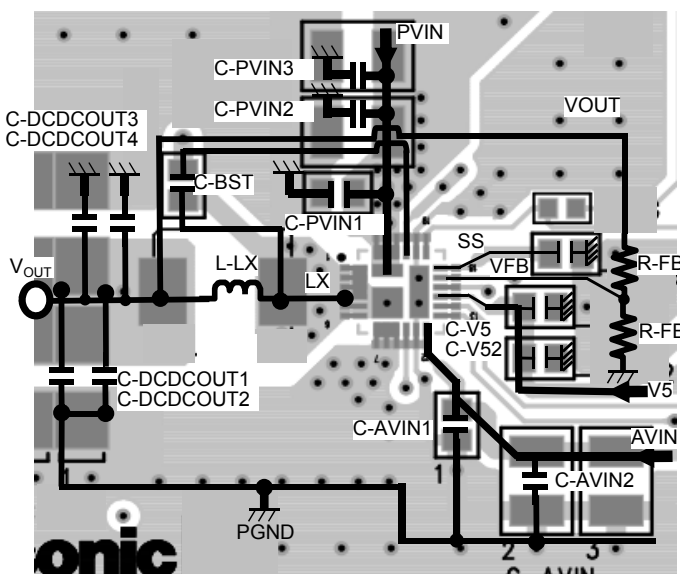

Figure : layout

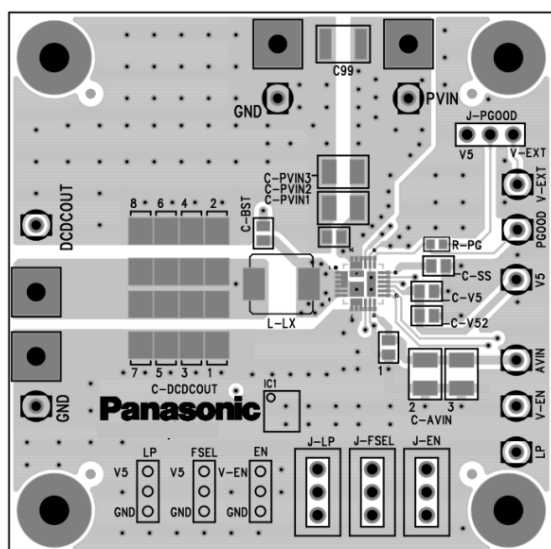

Figure : Top Layer with silk screen  
 (Top View) with Evaluation board

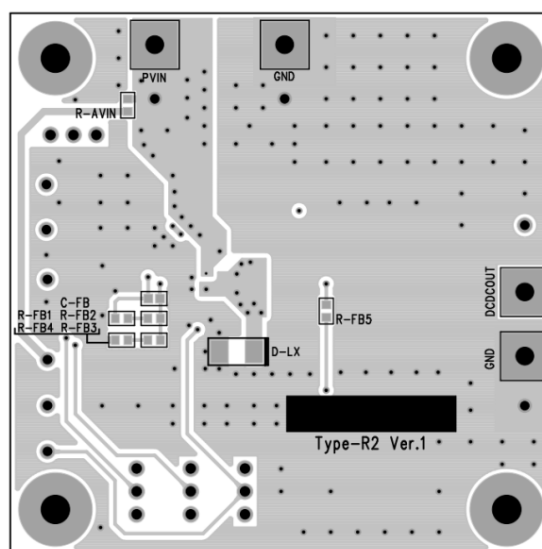

Figure : Bottom Layer with silk screen  
 (Bottom View) with Evaluation board

Notes) This application circuit and layout is an example. The operation of mass production set is not guaranteed. You should perform enough evaluation and verification on the design of mass production set. You are fully responsible for the incorporation of the above application circuit and information in the design of your equipment.

**APPLICATIONS INFORMATION (Continued)**

**2. Layout Recommendations**

Board layout considerations are necessary for stable operation of the DC-DC regulator. The following precautions must be used when designing the board layout.

- (a) The Input capacitor  $C_{IN}$  must be placed in such a way that the distance between PVIN and PGND is minimum, in order to suppress the switching noise. Stray inductance and impedance should be reduced as indicated by loop (1) in the figure below.
- (b) A single point ground connection (2) must be used to connect PGND and AGND to improve operation stability.
- (c) Output current line  $I_{OUT}$  and the output sense line VOUT must have small common impedance to reduce output load variations. Output sense line VOUT must be close to the output condenser  $C_O$  as indicated by (3) below.
- (d) Power Loss and output ripple voltage can be reduced by placing the inductor  $L_O$  and output capacitor  $C_O$  such that the stray inductance and the impedance of loop (4) is minimum. This is realized by :
  - i) Minimizing distance between inductor  $L_O$  and LX pin.
  - ii) Reducing distance between output capacitor  $C_O$  and (2) / (3)
- (e) Thick lines in the application circuit example represent lines with large current flow. These lines should be designed as thick as possible.
- (f) VFB / SS / V5 lines should be placed far away from LX line, BST line and inductor  $L_O$  to reduce the effects of switching noise. These lines should be designed as short as possible. This is especially true for the VFB line, which is a high impedance line.
- (g)  $R_{FB1}$  /  $R_{FB2}$  should also be placed as far away as possible from LX line, BST line and inductor  $L_O$  to minimize the effects of switching noise.  $R_{FB1}$  /  $R_{FB2}$  should be placed close to the VFB pin.
- (h) LX / BST lines are noisy lines. They should be designed as short as possible.

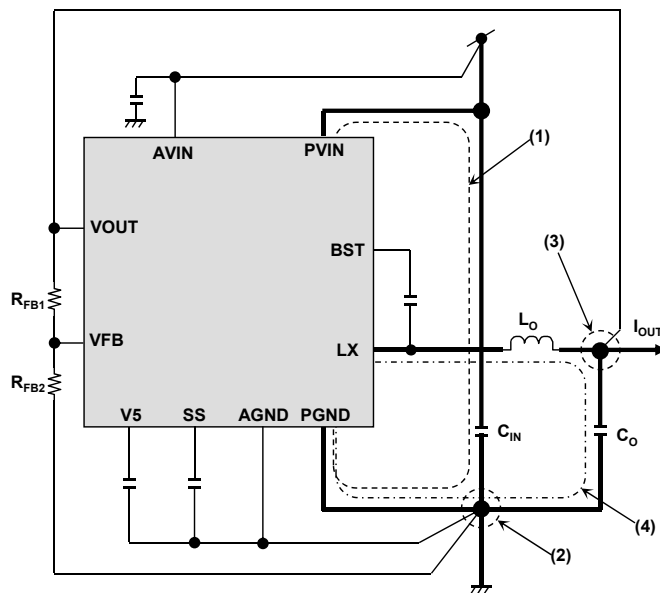

Figure : Application circuit diagram

Note : The application circuit diagram and layout diagram explained in this section, should be used as reference examples. The operation of the mass production set is not guaranteed. Sufficient evaluation and verification is required in the design of the mass production set. The Customer is fully responsible for the incorporation of the above illustrated application circuit and the information attached with it, in the design of the equipment.

**APPLICATIONS INFORMATION (Continued)**

**3. Recommended component**

Reference Designator	QTY	Value	Manufacturer	Part Number	Note
C-AVIN1	1	0.1 $\mu$ F	Murata	GRM188R72A104KA35L	—
C-AVIN2	1	1 $\mu$ F	Murata	GRM21BR71H105KA12L	—
C-BST	1	0.1 $\mu$ F	Murata	GRM188R72A104KA35L	—
C-DCDCOUT1 C-DCDCOUT2 C-DCDCOUT3 C-DCDCOUT4	4	22 $\mu$ F	Murata	GRM31CR70J226KE19L	—
C-PVIN1	1	0.1 $\mu$ F	Murata	GRM188R72A104KA35L	—
C-PVIN2, 3	2	10 $\mu$ F	TAIYO YUDEN	UMK325AB7106MM-T	—
C-SS	1	3.3 nF	Murata	GRM188R72A332KA01L	—
C-V5	1	0.1 $\mu$ F	Murata	GRM188R72A104KA35L	—
C-V52	1	4.7 $\mu$ F	Murata	GRM21BR71A475KA73	—
L-LX	1	1 $\mu$ H	ALPS GREEN DEVICE	GLMC1R003A	—
R-FB1	1	0 $\Omega$	Panasonic	ERJ3GEY0R00V	—
R-FB2	1	27 k $\Omega$	Panasonic	ERJ3EKF2702V	—
R-RB3	1	36 k $\Omega$	Panasonic	ERJ3EKF3602V	—
R-FB4	1	0 $\Omega$	Panasonic	ERJ3GEY0R00V	—
R-PG	1	100 k $\Omega$	Panasonic	ERJ3EKF1003V	—

**APPLICATIONS INFORMATION (Continued)**

**4. Special attention and precaution in using**

This IC is intended to be used for general electronic equipment. Ensure that the IC is used within the recommended safe operating region illustrated by the reference graph below. Do take note that thermal performance may varies with PCB design and PCB materials. You are encourage to use the graph only as a reference for your design and discuss further with our application engineer.

It is to be understood that our company shall not be held responsible for any damage incurred as a result of application beyond the recommended safe operating region.

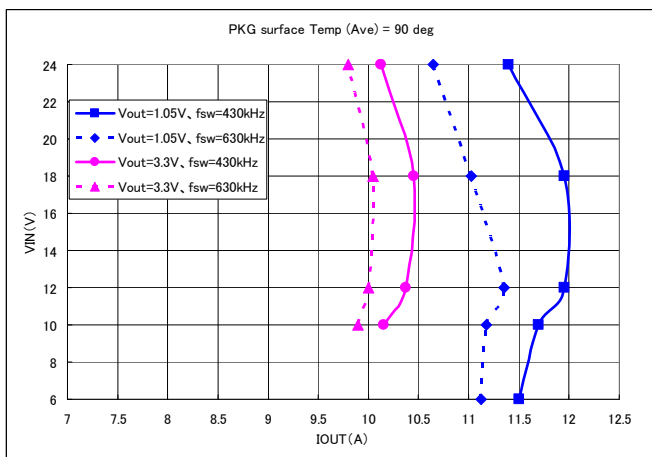
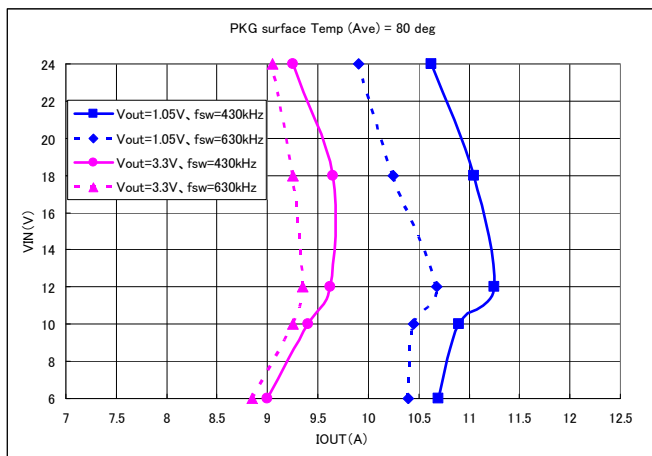

**PACKAGE INFORMATION**

**Outline Drawing**

Package Code : HQFN024-A3-0404DZF

Unit : mm

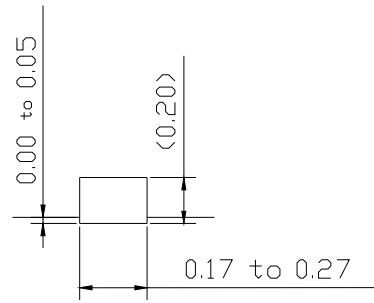
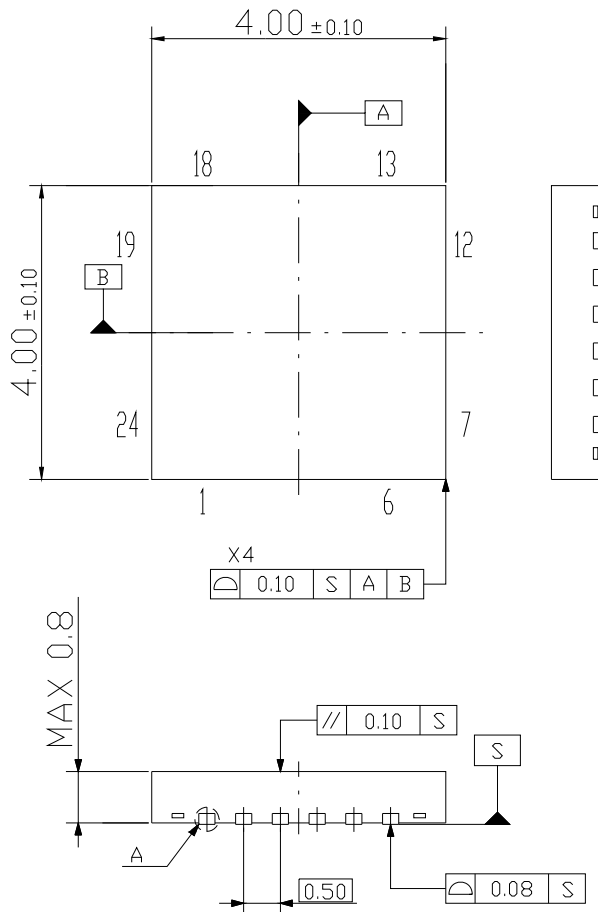

Detail \*A (Reference)

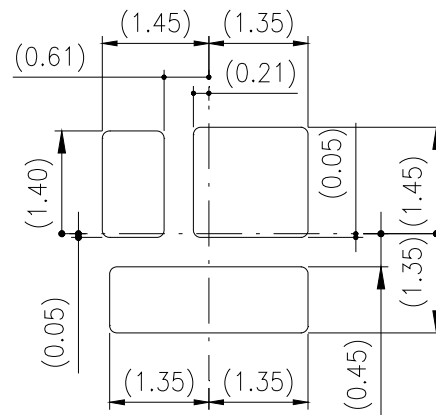

Detail Diepad Expose

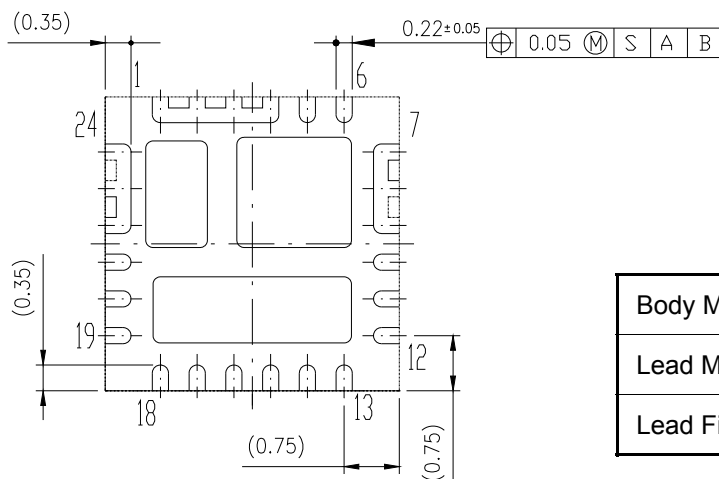

Body Material	: Br / Sb Free Epoxy Resin
Lead Material	: Cu Alloy
Lead Finish Method	: Pd Plating

## IMPORTANT NOTICE

1. When using the IC for new models, verify the safety including the long-term reliability for each product.
2. When the application system is designed by using this IC, please confirm the notes in this book.  
Please read the notes to descriptions and the usage notes in the book.
3. This IC is intended to be used for general electronic equipment.  
Consult our sales staff in advance for information on the following applications: Special applications in which exceptional quality and reliability are required, or if the failure or malfunction of this IC may directly jeopardize life or harm the human body. Any applications other than the standard applications intended.
  - (1) Space appliance (such as artificial satellite, and rocket)
  - (2) Traffic control equipment (such as for automotive, airplane, train, and ship)
  - (3) Medical equipment for life support
  - (4) Submarine transponder
  - (5) Control equipment for power plant
  - (6) Disaster prevention and security device
  - (7) Weapon
  - (8) Others : Applications of which reliability equivalent to (1) to (7) is requiredOur company shall not be held responsible for any damage incurred as a result of or in connection with the IC being used for any special application, unless our company agrees to the use of such special application.  
However, for the IC which we designate as products for automotive use, it is possible to be used for automotive.
4. This IC is neither designed nor intended for use in automotive applications or environments unless the IC is designated by our company to be used in automotive applications.  
Our company shall not be held responsible for any damage incurred by customers or any third party as a result of or in connection with the IC being used in automotive application, unless our company agrees to such application in this book.
5. Please use this IC in compliance with all applicable laws and regulations that regulate the inclusion or use of controlled substances, including without limitation, the EU RoHS Directive. Our company shall not be held responsible for any damage incurred as a result of our IC being used by our customers, not complying with the applicable laws and regulations.
6. Pay attention to the direction of the IC. When mounting it in the wrong direction onto the PCB (printed-circuit-board), it might be damaged.
7. Pay attention in the PCB (printed-circuit-board) pattern layout in order to prevent damage due to short circuit between pins. In addition, refer to the Pin Description for the pin configuration.
8. Perform visual inspection on the PCB before applying power, otherwise damage might happen due to problems such as solder-bridge between the pins of the IC. Also, perform full technical verification on the assembly quality, because the same damage possibly can happen due to conductive substances, such as solder ball, that adhere to the IC during transportation.
9. Take notice in the use of this IC that it might be damaged when an abnormal state occurs such as output pin-VCC short (Power supply fault), output pin-GND short (Ground fault), or output-to-output-pin short (load short). Safety measures such as installation of fuses are recommended because the extent of the above-mentioned damage will depend on the current capability of the power supply.
10. The protection circuit is for maintaining safety against abnormal operation. Therefore, the protection circuit should not work during normal operation.  
Especially for the thermal protection circuit, if the area of safe operation or the absolute maximum rating is momentarily exceeded due to output pin to VCC short (Power supply fault), or output pin to GND short (Ground fault), the IC might be damaged before the thermal protection circuit could operate.
11. Unless specified in the product specifications, make sure that negative voltage or excessive voltage are not applied to the pins because the IC might be damaged, which could happen due to negative voltage or excessive voltage generated during the ON and OFF timing when the inductive load of a motor coil or actuator coils of optical pick-up is being driven.
12. Product which has specified ASO (Area of Safe Operation) should be operated in ASO
13. Verify the risks which might be caused by the malfunctions of external components.
14. Connect the metallic plates (fins) on the back side of the IC with their respective potentials (AGND, PVIN, LX). The thermal resistance and the electrical characteristics are guaranteed only when the metallic plates (fins) are connected with their respective potentials.

## Request for your special attention and precautions in using the technical information and semiconductors described in this book

- (1) If any of the products or technical information described in this book is to be exported or provided to non-residents, the laws and regulations of the exporting country, especially, those with regard to security export control, must be observed.
- (2) The technical information described in this book is intended only to show the main characteristics and application circuit examples of the products. No license is granted in and to any intellectual property right or other right owned by Panasonic Corporation or any other company. Therefore, no responsibility is assumed by our company as to the infringement upon any such right owned by any other company which may arise as a result of the use of technical information described in this book.
- (3) The products described in this book are intended to be used for general applications (such as office equipment, communications equipment, measuring instruments and household appliances), or for specific applications as expressly stated in this book.  
Consult our sales staff in advance for information on the following applications:
  - Special applications (such as for airplanes, aerospace, automotive equipment, traffic signaling equipment, combustion equipment, life support systems and safety devices) in which exceptional quality and reliability are required, or if the failure or malfunction of the products may directly jeopardize life or harm the human body.It is to be understood that our company shall not be held responsible for any damage incurred as a result of or in connection with your using the products described in this book for any special application, unless our company agrees to your using the products in this book for any special application.
- (4) The products and product specifications described in this book are subject to change without notice for modification and/or improvement. At the final stage of your design, purchasing, or use of the products, therefore, ask for the most up-to-date Product Standards in advance to make sure that the latest specifications satisfy your requirements.
- (5) When designing your equipment, comply with the range of absolute maximum rating and the guaranteed operating conditions (operating power supply voltage and operating environment etc.). Especially, please be careful not to exceed the range of absolute maximum rating on the transient state, such as power-on, power-off and mode-switching. Otherwise, we will not be liable for any defect which may arise later in your equipment.  
Even when the products are used within the guaranteed values, take into the consideration of incidence of break down and failure mode, possible to occur to semiconductor products. Measures on the systems such as redundant design, arresting the spread of fire or preventing glitch are recommended in order to prevent physical injury, fire, social damages, for example, by using the products.
- (6) Comply with the instructions for use in order to prevent breakdown and characteristics change due to external factors (ESD, EOS, thermal stress and mechanical stress) at the time of handling, mounting or at customer's process. When using products for which damp-proof packing is required, satisfy the conditions, such as shelf life and the elapsed time since first opening the packages.
- (7) This book may be not reprinted or reproduced whether wholly or partially, without the prior written permission of our company.

# AMEYA360

## Components Supply Platform

### Authorized Distribution Brand :



### Website :

Welcome to visit [www.ameya360.com](http://www.ameya360.com)

### Contact Us :

#### ➤ Address :

401 Building No.5, JiuGe Business Center, Lane 2301, Yishan Rd  
Minhang District, Shanghai , China

#### ➤ Sales :

Direct +86 (21) 6401-6692

Email [amall@ameya360.com](mailto:amall@ameya360.com)

QQ 800077892

Skype [ameyasales1](#) [ameyasales2](#)

#### ➤ Customer Service :

Email [service@ameya360.com](mailto:service@ameya360.com)

#### ➤ Partnership :

Tel +86 (21) 64016692-8333

Email [mkt@ameya360.com](mailto:mkt@ameya360.com)