

NL17SV16

Ultra-Low Voltage Buffer

The NL17SV16XV5T2 is an ultra-high performance single Buffer fabricated in sub-micron silicon gate 0.35 μm technology with excellent performance down to 0.9 V. This device is ideal for extremely high-speed and high-drive applications. Additionally, limitations of board space are no longer a constraint. The very small SOT-553 makes this device fit most tight designs and spaces.

The internal circuit is composed of three stages; including a buffered output which provides high noise immunity and stable output. The NL17SV16XV5T2 input structure provides protection when voltages up to 3.6 V are applied.

Features

- Extremely High Speed: 1.5 ns (Typ) at $V_{CC} = 3.3\text{ V}$
- Designed for 0.9 V to 3.6 V Operation
- Overvoltage Tolerance (OVT)* Input Permits Logic Translation
- Balanced $\pm 24\text{ mA}$ Output Drive @ 3.3 Volts
- Near Zero Static Supply Current
- Ultra-Tiny SOT-553 5 Pin Package Only 1.6 x 1.6 mm Footprint
- Ultra-Tiny SOT-553 5-Pin Package, only 1.6 x 1.6 x 0.6 mm
- These Devices are Pb-Free and are RoHS Compliant

Typical Applications

- Cellular
- Digital Camera
- PDA
- Digital Video

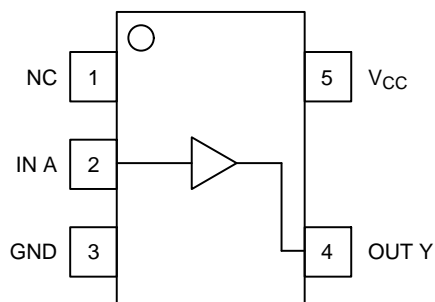

Figure 1. Pinout (Top View)

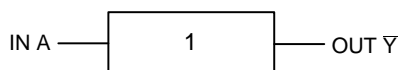

Figure 2. Logic Symbol



ON Semiconductor®

<http://onsemi.com>



SOT-553
CASE 463B

MARKING DIAGRAM

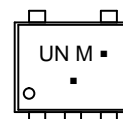

UN = Specific Device Code
M = Date Code
▪ = Pb-Free Package

(Note: Microdot may be in either location)

PIN ASSIGNMENT

PIN #	FUNCTION
1	NC
2	IN A
3	GND
4	OUT Y
5	V_{CC}

FUNCTION TABLE

Input A	Output Y
L	L
H	H

ORDERING INFORMATION

Device	Package	Shipping†
NL17SV16XV5T2G	SOT-553 (Pb-Free)	4000 / Tape & Reel

†For information on tape and reel specifications, including part orientation and tape sizes, please refer to our Tape and Reel Packaging Specifications Brochure, BRD8011/D.

*Overvoltage Tolerance (OVT) enables input pins to function outside (higher) of their operating voltages, with no damage to the devices or to signal integrity.

NL17SV16

MAXIMUM RATINGS

Symbol	Rating	Value	Units
V _{CC}	DC Supply Voltage	-0.5 to +4.6	V
V _I	DC Input Voltage	-0.5 to +4.6	V
V _O	DC Output Voltage	-0.5 to V _{CC} + 0.5	V
I _{IK}	DC Input Diode Current V _{IN} < 0 V	-50	mA
I _{OK}	DC Output Diode Current V _{OUT} < 0 V V _{OUT} > V _{CC}	-50 +50	mA
I _O	DC Output Sink Current	±50	mA
I _{CC}	DC Supply Current per Supply Pin	±50	mA
I _{GND}	DC Ground Current per Ground Pin	±50	mA
T _{STG}	Storage Temperature Range	-65 to +150	°C
T _L	Lead Temperature, 1.0 mm from Case for 10 seconds	260	°C
T _J	Junction Temperature Under Bias	+150	°C
θ _{JA}	Thermal Resistance (Note 1)	250	°C/W
P _D	Power Dissipation in Still Air at 85°C	250	mW
MSL	Moisture Sensitivity	Level 1	
F _R	Flammability Rating Oxygen index: 28 to 34	UL 94 V-0 @ 0125 in	
V _{ESD}	ESD Withstand Voltage Human Body Model (Note 2) Machine Model (Note 3)	2000 300	V

Stresses exceeding those listed in the Maximum Ratings table may damage the device. If any of these limits are exceeded, device functionality should not be assumed, damage may occur and reliability may be affected.

1. Measured with minimum pad spacing on an FR4 board, using 10 mm-by-1 inch, 2 ounce copper trace no air flow.
2. Tested to EIA/JESD22-A114-A.
3. Tested to EIA/JESD22-A115-A.

RECOMMENDED OPERATING CONDITIONS

Symbol	Parameter	Min	Max	Units
V _{CC}	Positive DC Supply Voltage	0.9	3.6	V
V _{IN}	Digital Input Voltage	0	3.6	V
V _{out}	Output Voltage	0	V _{CC}	V
I _{OH} /I _{OL}	Output Current V _{CC} = 3.0 V to 3.6 V V _{CC} = 2.3 V to 2.7 V V _{CC} = 1.65 V to 1.95 V V _{CC} = 1.4 V to 1.6 V V _{CC} = 1.1 V to 1.3 V V _{CC} = 0.9 V		±24 ±18 ±6 ±4 ±2 ±0.1	mA
t _A	Operating Temperature Range. All Package Types	-40	+85	°C
t _r , t _f	Input Rise or Fall Time V _{CC} = 3.3V ± 0.3 V	0	10	nS/V

Functional operation above the stresses listed in the Recommended Operating Ranges is not implied. Extended exposure to stresses beyond the Recommended Operating Ranges limits may affect device reliability.

NL17SV16

DC CHARACTERISTICS – Digital Section (Voltages Referenced to GND)

Symbol	Parameter	Condition	V _{CC}	T _A = 25°C		T _A = -40 to 85°C		Units
				Min	Max	Min	Max	
V _{IH}	High Level Input Voltage		0.90 1.10 ≤ V _{CC} ≤ 1.30 1.40 ≤ V _{CC} ≤ 1.60 1.65 ≤ V _{CC} ≤ 1.95 2.30 ≤ V _{CC} ≤ 2.70 2.70 ≤ V _{CC} ≤ 3.60	0.65 x V _{CC} 0.65 x V _{CC} 0.65 x V _{CC} 0.65 x V _{CC} 1.6 2.0		0.65 x V _{CC} 0.65 x V _{CC} 0.65 x V _{CC} 0.65 x V _{CC} 1.6 2.0		V
V _{IL}	Low Level Input Voltage		0.90 1.10 ≤ V _{CC} ≤ 1.30 1.40 ≤ V _{CC} ≤ 1.60 1.65 ≤ V _{CC} ≤ 1.95 2.30 ≤ V _{CC} ≤ 2.70 2.70 ≤ V _{CC} ≤ 3.60		0.35 x V _{CC} 0.35 x V _{CC} 0.35 x V _{CC} 0.35 x V _{CC} 0.7 0.8		0.35 x V _{CC} 0.35 x V _{CC} 0.35 x V _{CC} 0.35 x V _{CC} 0.7 0.8	V
V _{OH}	High Level Output Voltage	I _{OH} = -100 μA	0.90 1.10 ≤ V _{CC} ≤ 1.30 1.40 ≤ V _{CC} ≤ 1.60 1.65 ≤ V _{CC} ≤ 1.95 2.30 ≤ V _{CC} ≤ 2.70 2.70 ≤ V _{CC} ≤ 3.60	V _{CC} - 0.1 V _{CC} - 0.1 V _{CC} - 0.2 V _{CC} - 0.2 V _{CC} - 0.2 V _{CC} - 0.2		V _{CC} - 0.1 V _{CC} - 0.1 V _{CC} - 0.2 V _{CC} - 0.2 V _{CC} - 0.2 V _{CC} - 0.2		V
		I _{OH} = -2.0 mA	1.10 ≤ V _{CC} ≤ 1.30	0.75 x V _{CC}		0.75 x V _{CC}		
		I _{OH} = -4.0 mA	1.40 ≤ V _{CC} ≤ 1.60	0.75 x V _{CC}		0.75 x V _{CC}		
		I _{OH} = -6.0 mA	1.65 ≤ V _{CC} ≤ 1.95 2.30 ≤ V _{CC} ≤ 2.70	1.25 2.0		1.25 2.0		
		I _{OH} = -12 mA	2.30 ≤ V _{CC} ≤ 2.70 2.70 < V _{CC} ≤ 3.60	1.8 2.2		1.8 2.2		
		I _{OH} = -18 mA	2.30 ≤ V _{CC} ≤ 2.70 2.70 < V _{CC} ≤ 3.60	1.7 2.4		1.7 2.4		
		I _{OH} = -24 mA	2.70 ≤ V _{CC} ≤ 3.60	2.2		2.2		
V _{OL}	Low Level Output Voltage	I _{OL} = 100 μA	0.90 1.10 ≤ V _{CC} ≤ 1.30 1.40 ≤ V _{CC} ≤ 1.60 1.65 ≤ V _{CC} ≤ 1.95 2.30 ≤ V _{CC} ≤ 2.70 2.70 ≤ V _{CC} ≤ 3.60		0.1 0.1 0.2 0.2 0.2 0.2		0.1 0.1 0.2 0.2 0.2 0.2	V
		I _{OL} = 2.0 mA	1.10 ≤ V _{CC} ≤ 1.30		0.25 x V _{CC}		0.25 x V _{CC}	
		I _{OL} = 4.0 mA	1.40 ≤ V _{CC} ≤ 1.60		0.25 x V _{CC}		0.25 x V _{CC}	
		I _{OL} = 6.0 mA	1.65 ≤ V _{CC} ≤ 1.95		0.3		0.3	
		I _{OL} = 12 mA	2.30 ≤ V _{CC} ≤ 2.70 2.70 < V _{CC} ≤ 3.60		0.4 0.4		0.4 0.4	
		I _{OL} = 18 mA	2.30 ≤ V _{CC} ≤ 2.70 2.70 < V _{CC} ≤ 3.60		0.6 0.4		0.6 0.4	
		I _{OL} = 24 mA	2.70 ≤ V _{CC} ≤ 3.60		0.55		0.55	
I _{IN}	Input Leakage Current	0 = V _I = 3.6 V	0.90 to 3.60		±0.1		±0.9	μA
I _{OFF}	Power Off Leakage Current		0		1		5	μA
I _{CC}	Quiescent Supply Current	V _I = V _{CC} or GND	0.90 to 3.60		0.9		5	μA

NL17SV16

AC CHARACTERISTICS (Input $t_r = t_f = 3.0$ nS)

Symbol	Parameter	-40°C		25°C			85°C		Units
		Condition	V _{CC}	Min	Typ	Max	Min	Max	
T _{PHL} , T _{PLH}	Propagation Delay	C _L = 15 pF, R _L = 1.0 MΩ	0.90		20				nS
		C _L = 15 pF, R _L = 2.0 kΩ	1.10 ≤ V _{CC} ≤ 1.30 1.40 ≤ V _{CC} ≤ 1.60	2.0 1.0	6.0 3.2	13 6.1	1.0 1.0	16.9 7.0	nS
		C _L = 30 pF, R _L = 500 Ω	1.65 ≤ V _{CC} ≤ 1.95 2.30 ≤ V _{CC} ≤ 2.70 2.70 ≤ V _{CC} ≤ 3.60	1.0 0.8 0.7	2.0 1.2 1.0	5.2 3.7 3.3	1.0 0.7 0.6	6.2 4.4 3.8	nS
C _{IN}	Input Capacitance		0		2.0				pF
C _{OUT}	Output Capacitance		0		4.5				pF
C _{PD}	Power Dissipation Capacitance	V _I = 0 V or V _{CC} F = 10 MHz	0.90 to 3.60		20				pF

DEVICE JUNCTION TEMPERATURE VERSUS TIME TO 0.1% BOND FAILURES

Junction Temperature °C	Time, Hours	Time, Years
80	1,032,200	117.8
90	419,300	47.9
100	178,700	20.4
110	79,600	9.4
120	37,000	4.2
130	17,800	2.0
140	8,900	1.0

NL17SV16

PACKAGE DIMENSIONS

SOT-553, 5 LEAD CASE 463B ISSUE C

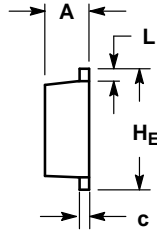
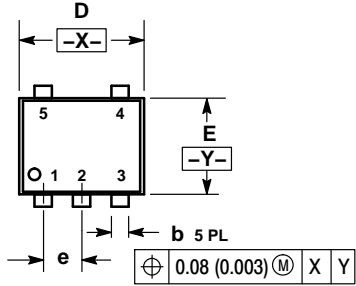

NOTES:

1. DIMENSIONING AND TOLERANCING PER ANSI Y14.5M, 1982.
2. CONTROLLING DIMENSION: MILLIMETERS
3. MAXIMUM LEAD THICKNESS INCLUDES LEAD FINISH THICKNESS. MINIMUM LEAD THICKNESS IS THE MINIMUM THICKNESS OF BASE MATERIAL.

DIM	MILLIMETERS			INCHES		
	MIN	NOM	MAX	MIN	NOM	MAX
A	0.50	0.55	0.60	0.020	0.022	0.024
b	0.17	0.22	0.27	0.007	0.009	0.011
c	0.08	0.13	0.18	0.003	0.005	0.007
D	1.55	1.60	1.65	0.061	0.063	0.065
E	1.15	1.20	1.25	0.045	0.047	0.049
e	0.50 BSC			0.020 BSC		
L	0.10	0.20	0.30	0.004	0.008	0.012
HE	1.55	1.60	1.65	0.061	0.063	0.065

RECOMMENDED SOLDERING FOOTPRINT*

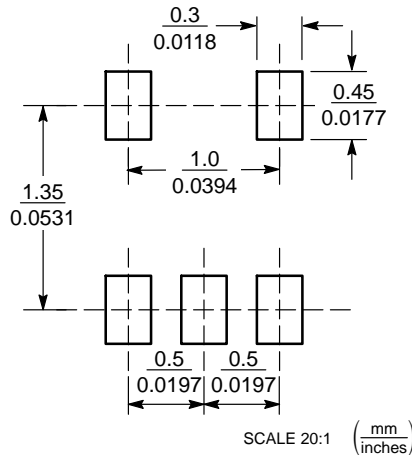

*For additional information on our Pb-Free strategy and soldering details, please download the ON Semiconductor Soldering and Mounting Techniques Reference Manual, SOLDERRM/D.

ON Semiconductor and  are registered trademarks of Semiconductor Components Industries, LLC (SCILLC). SCILLC owns the rights to a number of patents, trademarks, copyrights, trade secrets, and other intellectual property. A listing of SCILLC's product/patent coverage may be accessed at www.onsemi.com/site/pdf/Patent-Marking.pdf. SCILLC reserves the right to make changes without further notice to any products herein. SCILLC makes no warranty, representation or guarantee regarding the suitability of its products for any particular purpose, nor does SCILLC assume any liability arising out of the application or use of any product or circuit, and specifically disclaims any and all liability, including without limitation special, consequential or incidental damages. "Typical" parameters which may be provided in SCILLC data sheets and/or specifications can and do vary in different applications and actual performance may vary over time. All operating parameters, including "Typicals" must be validated for each customer application by customer's technical experts. SCILLC does not convey any license under its patent rights nor the rights of others. SCILLC products are not designed, intended, or authorized for use as components in systems intended for surgical implant into the body, or other applications intended to support or sustain life, or for any other application in which the failure of the SCILLC product could create a situation where personal injury or death may occur. Should Buyer purchase or use SCILLC products for any such unintended or unauthorized application, Buyer shall indemnify and hold SCILLC and its officers, employees, subsidiaries, affiliates, and distributors harmless against all claims, costs, damages, and expenses, and reasonable attorney fees arising out of, directly or indirectly, any claim of personal injury or death associated with such unintended or unauthorized use, even if such claim alleges that SCILLC was negligent regarding the design or manufacture of the part. SCILLC is an Equal Opportunity/Affirmative Action Employer. This literature is subject to all applicable copyright laws and is not for resale in any manner.

PUBLICATION ORDERING INFORMATION

LITERATURE FULFILLMENT:

Literature Distribution Center for ON Semiconductor
P.O. Box 5163, Denver, Colorado 80217 USA
Phone: 303-675-2175 or 800-344-3860 Toll Free USA/Canada
Fax: 303-675-2176 or 800-344-3867 Toll Free USA/Canada
Email: orderlit@onsemi.com

N. American Technical Support: 800-282-9855 Toll Free
USA/Canada
Europe, Middle East and Africa Technical Support:
Phone: 421 33 790 2910
Japan Customer Focus Center
Phone: 81-3-5817-1050

ON Semiconductor Website: www.onsemi.com

Order Literature: <http://www.onsemi.com/orderlit>

For additional information, please contact your local Sales Representative

AMEYA360

Components Supply Platform

Authorized Distribution Brand :



Website :

Welcome to visit www.ameya360.com

Contact Us :

➤ Address :

401 Building No.5, JiuGe Business Center, Lane 2301, Yishan Rd
Minhang District, Shanghai , China

➤ Sales :

Direct +86 (21) 6401-6692

Email amall@ameya360.com

QQ 800077892

Skype [ameyasales1](#) [ameyasales2](#)

➤ Customer Service :

Email service@ameya360.com

➤ Partnership :

Tel +86 (21) 64016692-8333

Email mkt@ameya360.com