

Using the TPS92010EVM-592 TRIAC Dimmable 6-W LED Driver

The TPS92010EVM-592 is a TRIAC dimmable LED driver. It can provide a 0.325-A constant current to four or five high-brightness LEDs. The EVM includes a five-LED load. It is powered from the mains which is rated at 100 Vrms to 130 Vrms. The output current can be modified for constant levels from 0.2 A to 0.7 A.

Contents

1	Description	2
2	Electrical Performance Specifications	2
3	Schematic	3
4	Test Setup	4
5	Test Procedure	7
6	Performance Data and Typical Characteristic Curves	9
7	List of Materials	10
8	References	11

List of Figures

1	TPS92010EVM-592 PSU (HPA594) Schematic	3
2	TPS92010EVM-592 LED Load Board Schematic	4
3	Resistor Locations Modify Output Current.....	5
4	Recommended Test Set-Up Using Internal Load.....	6
5	Recommended Test Set-Up using External Load	6
6	Recommended Test Set-Up Using TRIAC Dimmer	8
7	Efficiency vs. Input Voltage	9
8	Line Regulation.....	9
9	TPS92010EVM-592 Output Current vs Dimmer Phase Angle	9
10	TPS92010EVM-592 Output Current Ripple with Dimmer at 0% Dim	9

List of Tables

1	TPS92010EVM-592 Electrical Performance Specifications	2
2	Resistor Values to Modify Output Current	5
3	TPS92010EVM-592 List of Materials	10

1 Description

This EVM uses the TPS92010 high efficiency offline LED lighting driver controller. The power topology is a quasi resonant mode flyback. This makes for a cost competitive solution. This TPS92010 EVM implements a constant current, high efficiency, low ripple AC-DC LED lighting driver.

Current is sensed directly via a resistor and operational-amplifier. This in turn drives an opto-coupler which sets the PWM pulses via the TPS92010 to control the output current at a constant level. The design also incorporates a circuit to ensure compatibility with a large number of commonly available TRIAC based dimmers. This circuit monitors the line voltage for TRIAC operation. When the TRIAC is operating the line voltage is chopped. This information is used by the circuit to reduce the constant output current level thus dimming the LEDs. It also applies a current path at the input to ensure the TRIAC triggers correctly and maintains triggered condition.

1.1 Typical Applications

- Household light bulb replacement

1.2 Features

- TRIAC compatible dimming
- Low-cost line powered LED driver solution
- Includes 5 HB-LEDs as a sample load
- Allows easy use of user own LED load
- Test points for LED voltage and current
- Accurate current sensing to maintain constant current to LEDs
- Modifiable output current from 0.2 A to 0.7 A, 0.325 A is default

2 Electrical Performance Specifications

Table 1 gives the EVM performance specifications and qualifications.

Table 1. TPS92010EVM-592 Electrical Performance Specifications

SPECIFICATION		TEST CONDITIONS	MIN	TYP	MAX	UNITS
INPUT						
V_{IN}	Input voltage range		100		130	V_{RMS}
I_{MAX}	Maximum input current			132		mA_{RMS}
OUTPUT						
V_{OUT}	Output voltage		14		18	V_{DC}
I_{OUT}	Output current		310	325	340	mA_{DC}
SYSTEM						
η	Efficiency			84%		

3 Schematic

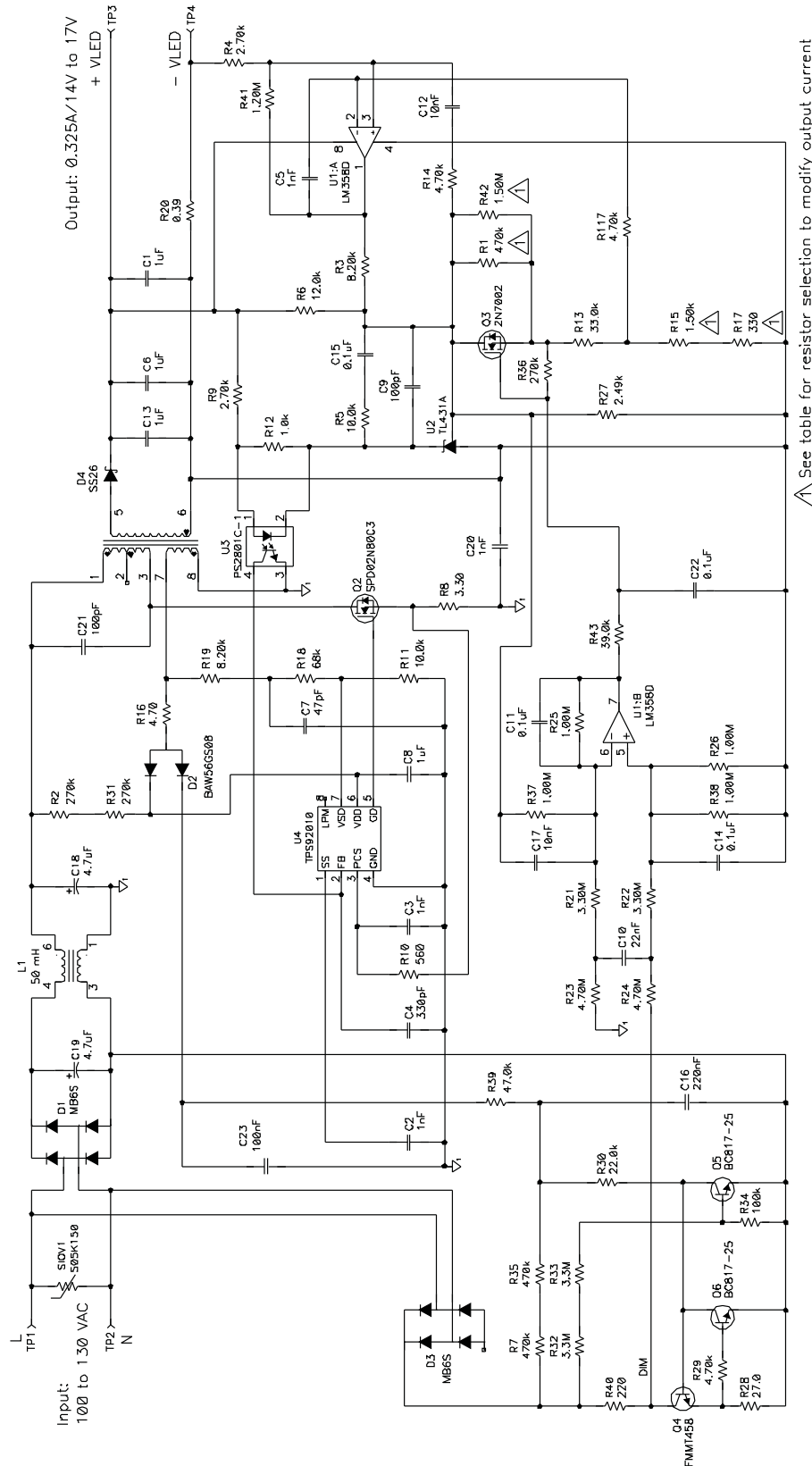
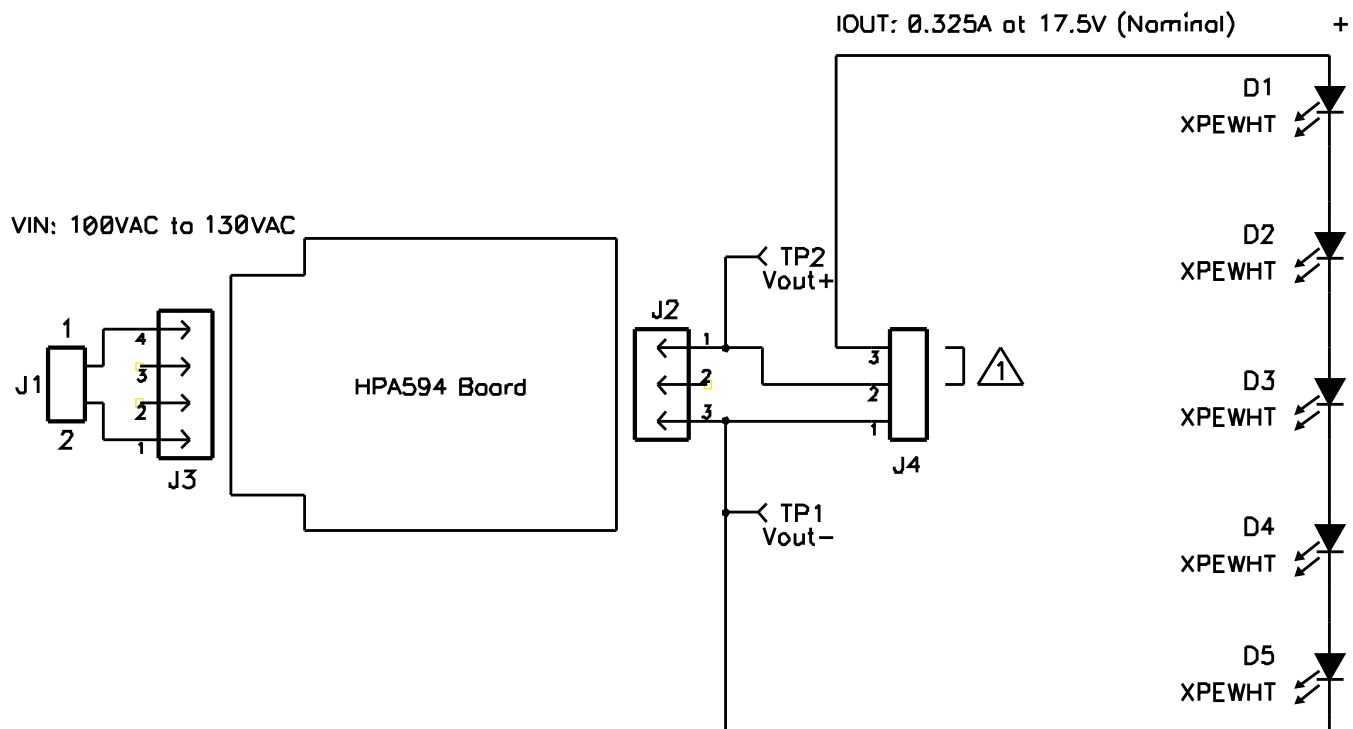

Figure 1. TPS92010EVM-592 PSU (HPA594) Schematic



 Short J4 pins 2 and 3 together to use on-board LEDs

Figure 2. TPS92010EVM-592 LED Load Board Schematic

4 Test Setup

4.1 Test Equipment

Connect test equipment and TPS51125AEVM board as shown in [Section 4.3](#).

4.1.1 Voltage Source

100 Vrms to 130 Vrms AC source.

4.1.2 Multimeters

Voltmeter for up to 20 Vdc and an ammeter for up to 1 A.

4.1.3 Output Load

Load provided or LED load that sinks 0.325 Adc and has a voltage drop between 14 Vdc to 18 Vdc.

4.1.4 Recommended Wire Gauge

18 AWG.

4.2 Configuring the Output Current

The TPS92010EVM-592 can be configured for different output current levels by soldering the 0402 parts. Table 2 below shows the resistor values necessary for various current levels. Figure 3 shows the location of these resistors on the top side of the PSU board.

Table 2. Resistor Values to Modify Output Current

MAXIMUM OUTPUT CURRENT (mA)	MINIMUM OUTPUT CURRENT (mA)	R15 (kΩ)	R17 (Ω)	R1 (kΩ)	R42 (MΩ)
200	10	1.00	150	330	1.00
225	10	1.20	86	390	1.00
250	10	1.20	220	470	1.00
275	10	1.00	560	680	0.68
300	10	1.50	220	680	0.68
325 ⁽¹⁾	10	1.50	330	470	1.50
350	10	1.00	1000	820	1.00
400	10	1.80	470	1000	1.00
450	10	2.20	390	1500	1.00
500	12	2.70	220	1500	1.00
600	12	3.30	150	1500	1.50
700	13	3.90	270	2200	1.50

⁽¹⁾ EVM default setting.

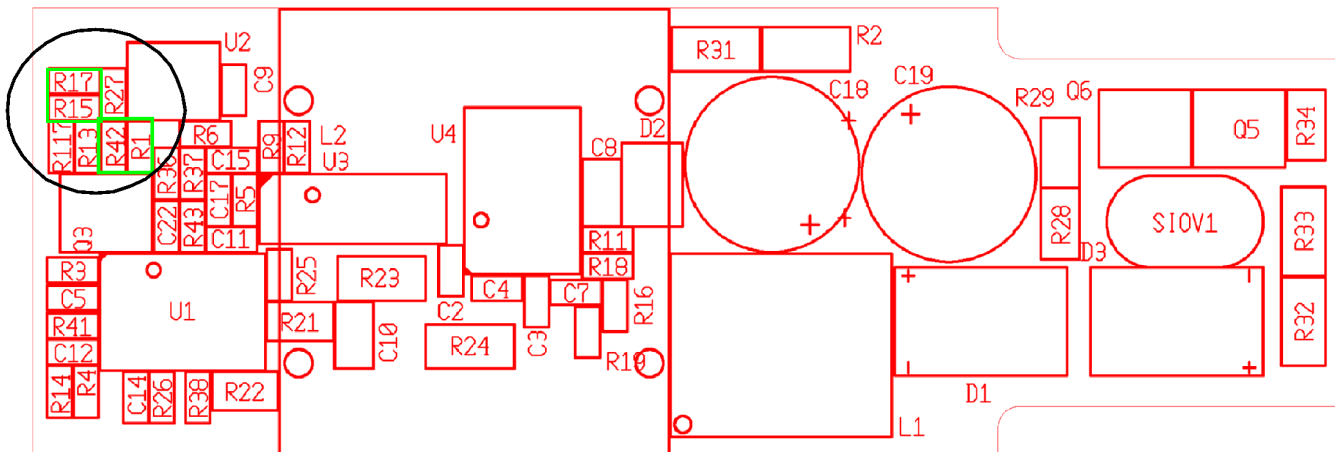

Figure 3. Resistor Locations Modify Output Current

4.3 Recommended Test Setup

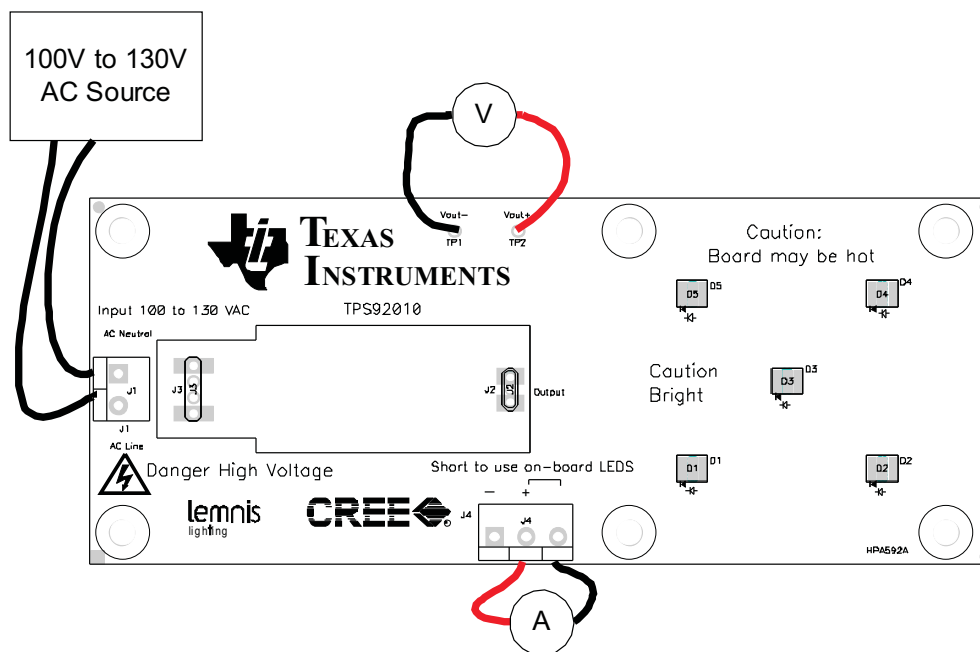

Figure 4. Recommended Test Set-Up Using Internal Load

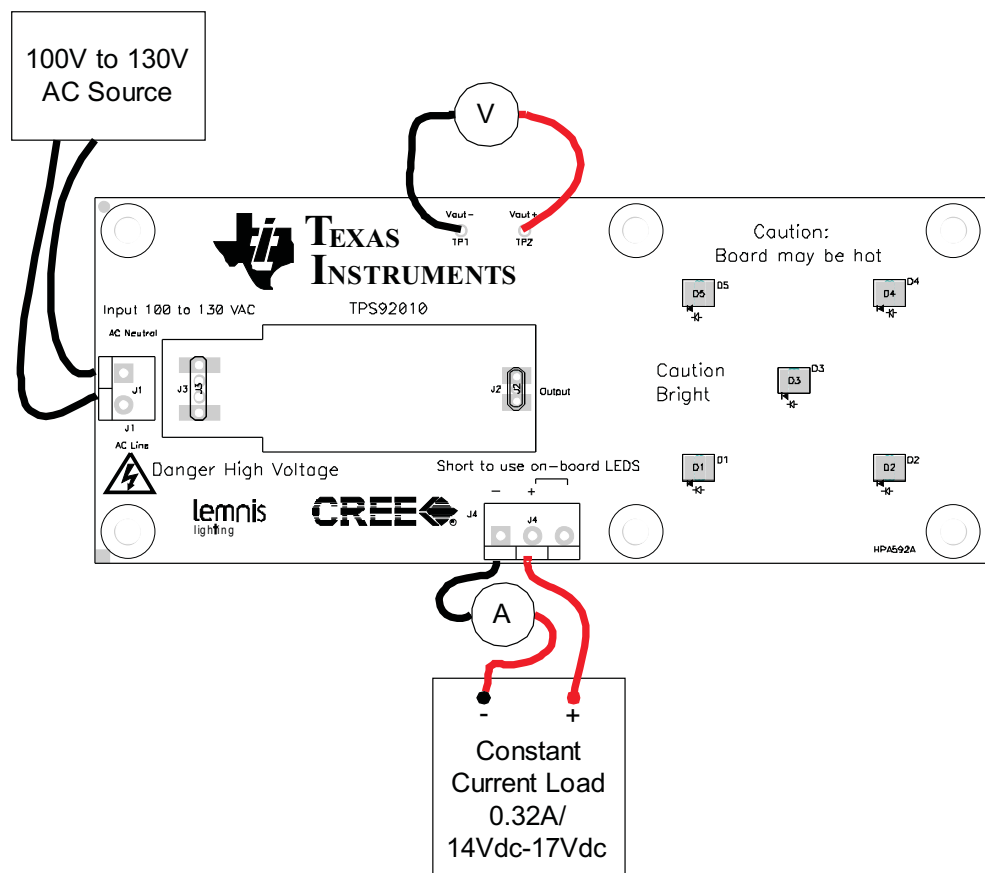

Figure 5. Recommended Test Set-Up using External Load

5 Test Procedure

CAUTION

High voltages exist on this EVM. Please handle with care. Do not touch EVM when powered

The user can set up the EVM in two different ways, with either an internal load or with an external load.

5.1 Internal Load

The EVM provides five on-board LEDs. A short or ammeter must be connected between pins 2 and 3 of J4, see [Figure 3](#).

5.2 External Load

To validate the EVM with an external load, pins 1 and 2 of J4 should be used. Any short between pins 2 and 3 should be removed to avoid damaging the EVM. See [Figure 5](#).

5.3 Line Regulation and Efficiency Measurement Procedure

1. Connect EVM per [Figure 4](#) or [Figure 5](#) .
2. Set AC source to 100 Vrms.
3. Turn on AC source.
4. Record output voltage reading from voltmeter and output current reading from ammeter
5. Increase output voltage by 5 Vrms
6. Repeat steps 4 and 5 until 130 Vrms is reached
7. Shutdown equipment per [Figure 5](#) .

5.4 Verifying Dimming Function

Figure 6 shows the recommended test set-up using the TRIAC dimmer.

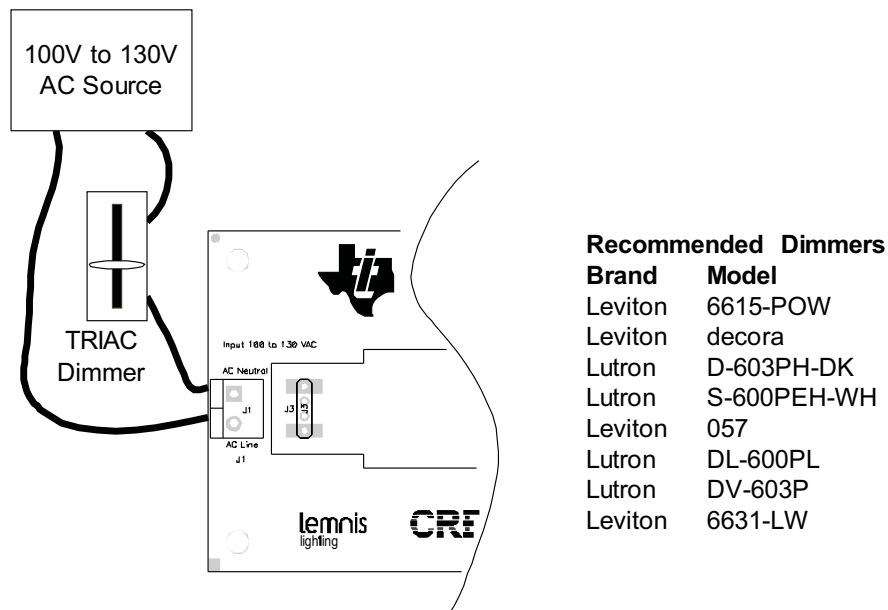

Figure 6. Recommended Test Set-Up Using TRIAC Dimmer

5.4.1 Equipment Start-Up

1. Set up the EVM per [Figure 4](#) or [Figure 5](#).
2. Add TRIAC dimmer to the input as shown in [Figure 6](#).
3. Set AC source to 120 Vrms.
4. Set TRIAC to maximum output.
5. Measure output current.
6. Slowly slide TRIAC dimmer to minimum output.
7. Observe output current reduces.

5.4.2 Equipment Shut-Down

1. Turn off AC source.
2. Wait several minutes before handling the EVM.

6 Performance Data and Typical Characteristic Curves

Figure 7 through Figure 10 show typical performance curves for the TPS92010EVM-592.

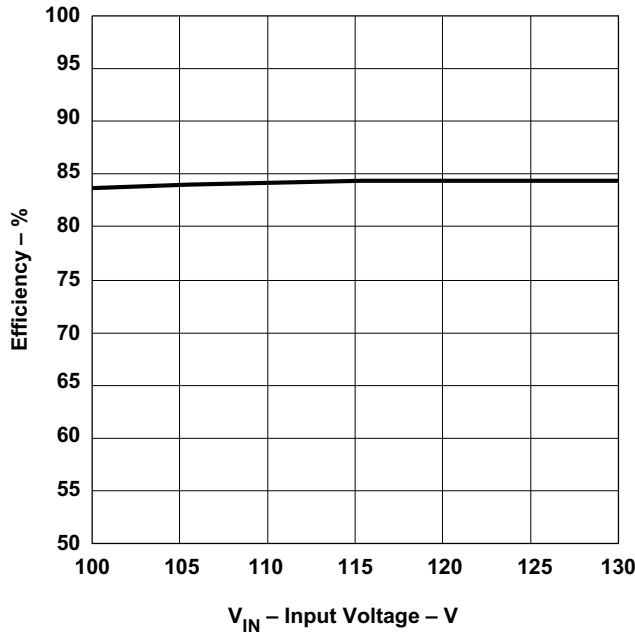

Figure 7. Efficiency vs. Input Voltage

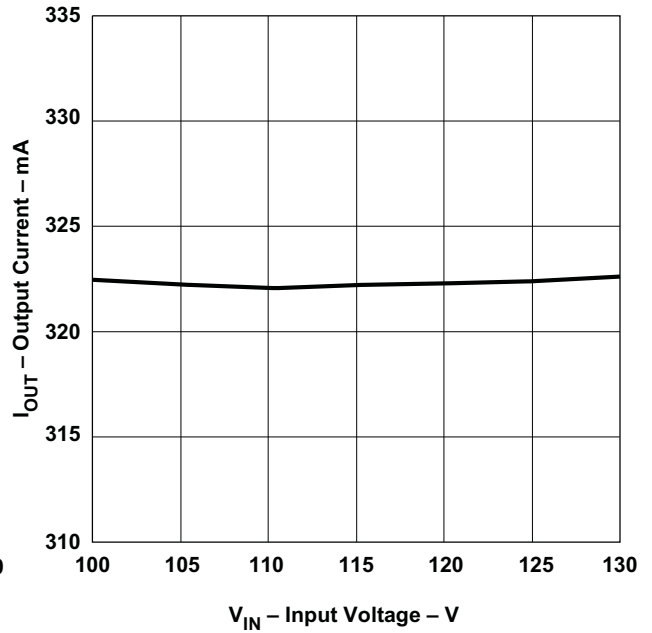

Figure 8. Line Regulation

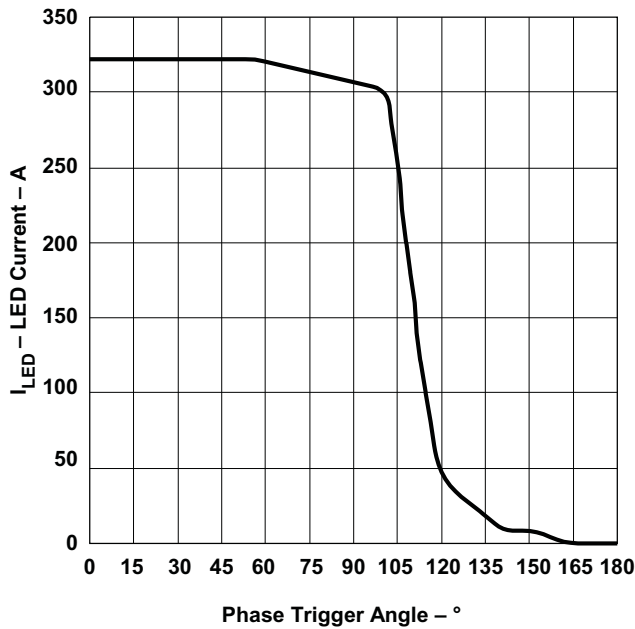

Figure 9. TPS92010EVM-592 Output Current vs Dimmer Phase Angle

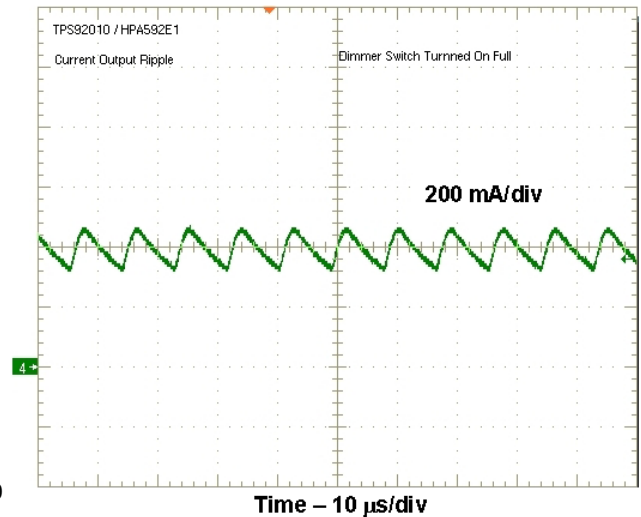

Figure 10. TPS92010EVM-592 Output Current Ripple with Dimmer at 0% Dim

7 List of Materials

List of materials for the TPS92010EVM-592.

Table 3. TPS92010EVM-592 List of Materials

REFERENCE DESIGNATOR	QTY	DESCRIPTION	MANUFAC	PART NUMBER
C1, C6, C13	3	Capacitor, ceramic, 1 μ F, 100 V, X7R, 10%, 1210	Std	Std
C2, C3, C5	3	Capacitor, ceramic, 1 nF, 50 V, X7R, 10%, 0402	Std	Std
C4	1	Capacitor, ceramic, 330 pF, 50 V, X7R, 10%, 0402	Std	Std
C7	1	Capacitor, ceramic, 47 pF, 50 V, COG, 5%, 0402	Std	Std
C8	1	Capacitor, ceramic, 1 μ F, 25 V, X7R, 10%, 0805	Std	Std
C9	1	Capacitor, ceramic, 100 pF, 50 V, COG, 5%, 0402	Std	Std
C10	1	Capacitor, ceramic, 22 nF, 100 V, X7R, 10%, 0805	Std	Std
C11, C14, C15	3	Capacitor, ceramic, 0.1 μ F, 16 V, X5R, 10%, 0402	Std	Std
C12, C17	2	Capacitor, ceramic, 10 nF, 50 V, X7R, 10%, 0402	Std	Std
C16	1	Capacitor, ceramic, 220 nF, 16 V, X7R, 10%, 0603	Std	Std
C18, C19	2	Capacitor, Aluminum, 4.7 μ F, \pm 20%, 250V, , 8 x 11.5 mm	Rubycon	250BXC4.7M8X11.5
C20	1	Capacitor, ceramic, 1 nF, X1Y2, 5kV, X7R, 10%, 1808	Std	Std
C21	1	Capacitor, ceramic, 100 pF, 1000 V, COG, 5%, 1206	Std	Std
C22	1	Capacitor, ceramic, 0.1 μ F, 100 V, X5R, 10%, 0402	Std	Std
C23	1	Capacitor, ceramic, 100 nF, 50 V, X7R, 10%, 0603	Std	Std
D1, D3	2	Diode, bridge rectifier, 0.5 A, x 00 V	Fairchild	MB6S
D2	1	Diode, dual , 250-mA, 70 V	Vishay-Liteon	BAW56GS08
D4	1	Diode, Schottky, 2-A, 60-V	STD	STD
L1	1	Inductor, common choke, \pm 10%	Würth	750310784
L2	1	Xfmr, flyback	Würth	750310787
Q2	1	MOSFET, N-channel, 800 V, 2.0 A, 2.7 Ω	Infineon	SPD02N80C3
Q3	1	MOSFET, N-channel, 60 V, 115 mA, 1.2 Ω	Diodes	2N7002
Q4	1	Transistor, NPN	Diodes	FMMT458TA
Q5, Q6	2	Transistor, NPN	Std	BC817-25
R1	1	Resistor, chip, 470 k Ω , 1/16W, 1%, 0402	Std	Std
R10	1	Resistor, chip, 560 Ω , 1/16W, 1%, 0402	Std	Std
R12	1	Resistor, chip, 1.0 Ω k, 1/16W, 5%, 0402	Std	Std
R13	1	Resistor, chip, 33.0 k Ω , 1/16W, 1%, 0402	Std	Std
R14, R117	2	Resistor, chip, 4.70 k Ω , 1/16W, 1%, 0402	Std	Std
R15	1	Resistor, chip, 1.50 k Ω , 1/16W, 1%, 0402	Std	Std
R16	1	Resistor, chip, 4.7 Ω , 1/16W, 5%, 0402	Std	Std
R17	1	Resistor, chip, 330 Ω , 1/16W, 1%, 0402	Std	Std
R18	1	Resistor, chip, 68 k Ω , 1/16W, 5%, 0402	Std	Std
R2, R31	2	Resistor, chip, 270 k Ω , 1/4W, 5%, 1206	Std	Std
R20	1	Resistor, chip, 0.39 Ω , 1/10W, 1%, 0805	Std	Std
R21, R22	2	Resistor, chip, 3.30 M Ω , 1/10W, 1%, 0805	Std	Std
R23, R24	2	Resistor, chip, 4.70 M Ω , 1/4W, 1%, 1206	Std	Std
R25, R26, R37, R38	4	Resistor, chip, 1.00 M Ω , 1/16W, 1%, 0402	Std	Std
R27	1	Resistor, chip, 2.49 k Ω , 1/16W, 1%, 0402	Std	Std
R28	1	Resistor, chip, 27 Ω , 1/16W, 5%, 0603	Std	Std
R29	1	Resistor, chip, 4.70 k Ω , 1/16W, 1%, 0603	Std	Std
R3, R19	2	Resistor, chip, 8.20 k Ω , 1/16W, 1%, 0402	Std	Std
R30	1	Resistor, chip, 22.0 k Ω , 1/16W, 1%, 0402	Std	Std

Table 3. TPS92010EVM-592 List of Materials (continued)

REFERENCE DESIGNATOR	QTY	DESCRIPTION	MANUFAC	PART NUMBER
R32, R33	2	Resistor, chip, 3.3 M Ω , 1/4W, 5%, 1206	Std	Std
R34	1	Resistor, chip, 100 k Ω , 1/16W, 1%, 0603	Std	Std
R7, R35	2	Resistor, chip, 470 k Ω , 1/4W, 5%, 1206	Std	Std
R36	1	Resistor, chip, 270 k Ω , 1/16W, 1%, 0402	Std	Std
R39	1	Resistor, chip, 47.0 k Ω , 1/4W, 1%, 1206	Std	Std
R4, R9	2	Resistor, chip, 2.70k, 1/16W, 1%, 0402	Std	Std
R40	1	Resistor, chip, 220 Ω , 1/16W, 5%, 0603	Std	Std
R41	1	Resistor, chip, 1.20 M Ω , 1/16W, 1%, 0402	Std	Std
R42	1	Resistor, chip, 1.50 M Ω , 1/16W, 1%, 0402	Std	Std
R43	1	Resistor, chip, 39.0 k Ω , 1/16W, 1%, 0402	Std	Std
R5, R11	2	Resistor, chip, 10.0 k Ω , 1/16W, 1%, 0402	Std	Std
R6	1	Resistor, chip, 12.0 k Ω , 1/16W, 1%, 0402	Std	Std
R8	1	Resistor, chip, 3.3 Ω , 1/16W, 5%, 0603	Std	Std
SIOV1	1	Varistor, disk, 150 V, 1W, TA @ 85C°	Epcos	SIOV-S05K150
U1	1	IC, dual operational amplifiers	TI	LM358AD
U2	1	Diode, adjustable shunt regulator, 2.49 V to 36 V, 20 mA	TI	TL431A
U3	1	IC, high-isolation voltage photocoupler	CEL	PS2801C-1-A
U4	1	IC, 8-pin high-efficiency, offline LED lighting controller	TI	TPS92010
--	1	PCB, 60 mm x 20.6 mm x 1.62 mm	Any	HPA594
LOAD MATERIALS				
D1, D2, D3, D4, D5	5	HB-LED, 0.7 A (maximum), 3.9 Vdc	Cree	XPEWHT-L1-0000-00BE7

8 References

TPS92010 Datasheet, High Efficiency Offline LED Lighting Driver Controller ([SLUSA14](#))

EVALUATION BOARD/KIT IMPORTANT NOTICE

Texas Instruments (TI) provides the enclosed product(s) under the following conditions:

This evaluation board/kit is intended for use for **ENGINEERING DEVELOPMENT, DEMONSTRATION, OR EVALUATION PURPOSES ONLY** and is not considered by TI to be a finished end-product fit for general consumer use. Persons handling the product(s) must have electronics training and observe good engineering practice standards. As such, the goods being provided are not intended to be complete in terms of required design-, marketing-, and/or manufacturing-related protective considerations, including product safety and environmental measures typically found in end products that incorporate such semiconductor components or circuit boards. This evaluation board/kit does not fall within the scope of the European Union directives regarding electromagnetic compatibility, restricted substances (RoHS), recycling (WEEE), FCC, CE or UL, and therefore may not meet the technical requirements of these directives or other related directives.

Should this evaluation board/kit not meet the specifications indicated in the User's Guide, the board/kit may be returned within 30 days from the date of delivery for a full refund. **THE FOREGOING WARRANTY IS THE EXCLUSIVE WARRANTY MADE BY SELLER TO BUYER AND IS IN LIEU OF ALL OTHER WARRANTIES, EXPRESSED, IMPLIED, OR STATUTORY, INCLUDING ANY WARRANTY OF MERCHANTABILITY OR FITNESS FOR ANY PARTICULAR PURPOSE.**

The user assumes all responsibility and liability for proper and safe handling of the goods. Further, the user indemnifies TI from all claims arising from the handling or use of the goods. Due to the open construction of the product, it is the user's responsibility to take any and all appropriate precautions with regard to electrostatic discharge.

EXCEPT TO THE EXTENT OF THE INDEMNITY SET FORTH ABOVE, NEITHER PARTY SHALL BE LIABLE TO THE OTHER FOR ANY INDIRECT, SPECIAL, INCIDENTAL, OR CONSEQUENTIAL DAMAGES.

TI currently deals with a variety of customers for products, and therefore our arrangement with the user **is not exclusive.**

TI assumes **no liability for applications assistance, customer product design, software performance, or infringement of patents or services described herein.**

Please read the User's Guide and, specifically, the Warnings and Restrictions notice in the User's Guide prior to handling the product. This notice contains important safety information about temperatures and voltages. For additional information on TI's environmental and/or safety programs, please contact the TI application engineer or visit www.ti.com/esh.

No license is granted under any patent right or other intellectual property right of TI covering or relating to any machine, process, or combination in which such TI products or services might be or are used.

FCC Warning

This evaluation board/kit is intended for use for **ENGINEERING DEVELOPMENT, DEMONSTRATION, OR EVALUATION PURPOSES ONLY** and is not considered by TI to be a finished end-product fit for general consumer use. It generates, uses, and can radiate radio frequency energy and has not been tested for compliance with the limits of computing devices pursuant to part 15 of FCC rules, which are designed to provide reasonable protection against radio frequency interference. Operation of this equipment in other environments may cause interference with radio communications, in which case the user at his own expense will be required to take whatever measures may be required to correct this interference.

EVALUATION BOARD/KIT/MODULE (EVM) WARNINGS, RESTRICTIONS AND DISCLAIMER

For Feasibility Evaluation Only, in Laboratory/Development Environments. The EVM is not a complete product. It is intended solely for use for preliminary feasibility evaluation in laboratory / development environments by technically qualified electronics experts who are familiar with the dangers and application risks associated with handling electrical / mechanical components, systems and subsystems. It should not be used as all or part of a production unit.

Your Sole Responsibility and Risk. You acknowledge, represent and agree that

1. You have unique knowledge concerning Federal, State and local regulatory requirements (including but not limited to Food and Drug Administration regulations, if applicable) which relate to your products and which relate to your use (and/or that of your employees, affiliates, contractors or designees) of the EVM for evaluation, testing and other purposes.
2. You have full and exclusive responsibility to assure the safety and compliance of your products with all such laws and other applicable regulatory requirements, and also to assure the safety of any activities to be conducted by you and/or your employees, affiliates, contractors or designees, using the EVM. Further, you are responsible to assure that any interfaces (electronic and/or mechanical) between the EVM and any human body are designed with suitable isolation and means to safely limit accessible leakage currents to minimize the risk of electrical shock hazard.
3. Since the EVM is not a completed product, it may not meet all applicable regulatory and safety compliance standards (such as UL, CSA, VDE, CE, RoHS and WEEE) which may normally be associated with similar items. You assume full responsibility to determine and/or assure compliance with any such standards and related certifications as may be applicable. You will employ reasonable safeguards to ensure that your use of the EVM will not result in any property damage, injury or death, even if the EVM should fail to perform as described or expected.

Certain Instructions. Exceeding the specified EVM ratings (including but not limited to input and output voltage, current, power, and environmental ranges) may cause property damage, personal injury or death. If there are questions concerning these ratings please contact a TI field representative prior to connecting interface electronics including input power and intended loads. Any loads applied outside of the specified output range may result in unintended and/or inaccurate operation and/or possible permanent damage to the EVM and/or interface electronics. Please consult the EVM User's Guide prior to connecting any load to the EVM output. If there is uncertainty as to the load specification, please contact a TI field representative. During normal operation, some circuit components may have case temperatures greater than 60°C as long as the input and output ranges are maintained at nominal ambient operating temperature. These components include but are not limited to linear regulators, switching transistors, pass transistors, and current sense resistors which can be identified using the EVM schematic located in the EVM User's Guide. When placing measurement probes near these devices during normal operation, please be aware that these devices may be very warm to the touch.

EVALUATION BOARD/KIT/MODULE (EVM) WARNINGS, RESTRICTIONS AND DISCLAIMER (continued)

Agreement to Defend, Indemnify and Hold Harmless. You agree to defend, indemnify and hold TI, its licensors and their representatives harmless from and against any and all claims, damages, losses, expenses, costs and liabilities (collectively, "Claims") arising out of or in connection with any use of the EVM that is not in accordance with the terms of this agreement. This obligation shall apply whether Claims arise under the law of tort or contract or any other legal theory, and even if the EVM fails to perform as described or expected.

Safety-Critical or Life-Critical Applications. If you intend to evaluate TI components for possible use in safety-critical applications (such as life support) where a failure of the TI product would reasonably be expected to cause severe personal injury or death, such as devices which are classified as FDA Class III or similar classification, then you must specifically notify TI of such intent and enter into a separate Assurance and Indemnity Agreement.

Mailing Address: Texas Instruments, Post Office Box 655303, Dallas, Texas 75265
Copyright © 2008, Texas Instruments Incorporated

IMPORTANT NOTICE

Texas Instruments Incorporated and its subsidiaries (TI) reserve the right to make corrections, modifications, enhancements, improvements, and other changes to its products and services at any time and to discontinue any product or service without notice. Customers should obtain the latest relevant information before placing orders and should verify that such information is current and complete. All products are sold subject to TI's terms and conditions of sale supplied at the time of order acknowledgment.

TI warrants performance of its hardware products to the specifications applicable at the time of sale in accordance with TI's standard warranty. Testing and other quality control techniques are used to the extent TI deems necessary to support this warranty. Except where mandated by government requirements, testing of all parameters of each product is not necessarily performed.

TI assumes no liability for applications assistance or customer product design. Customers are responsible for their products and applications using TI components. To minimize the risks associated with customer products and applications, customers should provide adequate design and operating safeguards.

TI does not warrant or represent that any license, either express or implied, is granted under any TI patent right, copyright, mask work right, or other TI intellectual property right relating to any combination, machine, or process in which TI products or services are used. Information published by TI regarding third-party products or services does not constitute a license from TI to use such products or services or a warranty or endorsement thereof. Use of such information may require a license from a third party under the patents or other intellectual property of the third party, or a license from TI under the patents or other intellectual property of TI.

Reproduction of TI information in TI data books or data sheets is permissible only if reproduction is without alteration and is accompanied by all associated warranties, conditions, limitations, and notices. Reproduction of this information with alteration is an unfair and deceptive business practice. TI is not responsible or liable for such altered documentation. Information of third parties may be subject to additional restrictions.

Resale of TI products or services with statements different from or beyond the parameters stated by TI for that product or service voids all express and any implied warranties for the associated TI product or service and is an unfair and deceptive business practice. TI is not responsible or liable for any such statements.

TI products are not authorized for use in safety-critical applications (such as life support) where a failure of the TI product would reasonably be expected to cause severe personal injury or death, unless officers of the parties have executed an agreement specifically governing such use. Buyers represent that they have all necessary expertise in the safety and regulatory ramifications of their applications, and acknowledge and agree that they are solely responsible for all legal, regulatory and safety-related requirements concerning their products and any use of TI products in such safety-critical applications, notwithstanding any applications-related information or support that may be provided by TI. Further, Buyers must fully indemnify TI and its representatives against any damages arising out of the use of TI products in such safety-critical applications.

TI products are neither designed nor intended for use in military/aerospace applications or environments unless the TI products are specifically designated by TI as military-grade or "enhanced plastic." Only products designated by TI as military-grade meet military specifications. Buyers acknowledge and agree that any such use of TI products which TI has not designated as military-grade is solely at the Buyer's risk, and that they are solely responsible for compliance with all legal and regulatory requirements in connection with such use.

TI products are neither designed nor intended for use in automotive applications or environments unless the specific TI products are designated by TI as compliant with ISO/TS 16949 requirements. Buyers acknowledge and agree that, if they use any non-designated products in automotive applications, TI will not be responsible for any failure to meet such requirements.

Following are URLs where you can obtain information on other Texas Instruments products and application solutions:

Products		Applications	
Amplifiers	amplifier.ti.com	Audio	www.ti.com/audio
Data Converters	dataconverter.ti.com	Automotive	www.ti.com/automotive
DLP® Products	www.dlp.com	Communications and Telecom	www.ti.com/communications
DSP	dsp.ti.com	Computers and Peripherals	www.ti.com/computers
Clocks and Timers	www.ti.com/clocks	Consumer Electronics	www.ti.com/consumer-apps
Interface	interface.ti.com	Energy	www.ti.com/energy
Logic	logic.ti.com	Industrial	www.ti.com/industrial
Power Mgmt	power.ti.com	Medical	www.ti.com/medical
Microcontrollers	microcontroller.ti.com	Security	www.ti.com/security
RFID	www.ti-rfid.com	Space, Avionics & Defense	www.ti.com/space-avionics-defense
RF/IF and ZigBee® Solutions	www.ti.com/lprf	Video and Imaging	www.ti.com/video
		Wireless	www.ti.com/wireless-apps

AMEYA360

Components Supply Platform

Authorized Distribution Brand :



Website :

Welcome to visit www.ameya360.com

Contact Us :

➤ Address :

401 Building No.5, JiuGe Business Center, Lane 2301, Yishan Rd
Minhang District, Shanghai , China

➤ Sales :

Direct +86 (21) 6401-6692

Email amall@ameya360.com

QQ 800077892

Skype [ameyasales1](#) [ameyasales2](#)

➤ Customer Service :

Email service@ameya360.com

➤ Partnership :

Tel +86 (21) 64016692-8333

Email mkt@ameya360.com