

Evaluation Board for the CS4354

Features

- ◆ Requires Only a Digital Signal Source and a +5 V Power Supply for a Complete Digital-to-Analog Converter System
- ◆ Demonstrates Recommended Layout and Grounding Arrangements
- ◆ CS8416 Receives S/PDIF, & EIAJ-340-Compatible Digital Audio
- ◆ Header for External PCM Audio
- ◆ Single-ended Stereo Analog Outputs
- ◆ Power and S/PDIF Error Indicator LEDs
- ◆ Hardware Controls: +5 V/3.3 V select for VL, De-emphasis select
- ◆ Current Sense Resistors for CS4354 Supplies (VA and VL)

Description

The CDB4354 evaluation board is a dedicated platform designed to facilitate the evaluation of the CS4354 24-bit, stereo D/A converter. Evaluation requires an analog signal analyzer, a digital signal source, and a +5 V power supply. Analog line-level outputs are provided via RCA phono jacks.

The CS8416 digital audio receiver IC provides the system timing necessary to operate the Digital-to-Analog converter and will accept S/PDIF and EIAJ-340-compatible audio data. The evaluation board may also be configured to accept external timing and data signals for operation in a custom user application during system development.

To accommodate various system configurations, several hardware controls and resistor population options are provided. Current sense resistors allow for easy power calculations during system development.

ORDERING INFORMATION

CDB4354

Evaluation Board

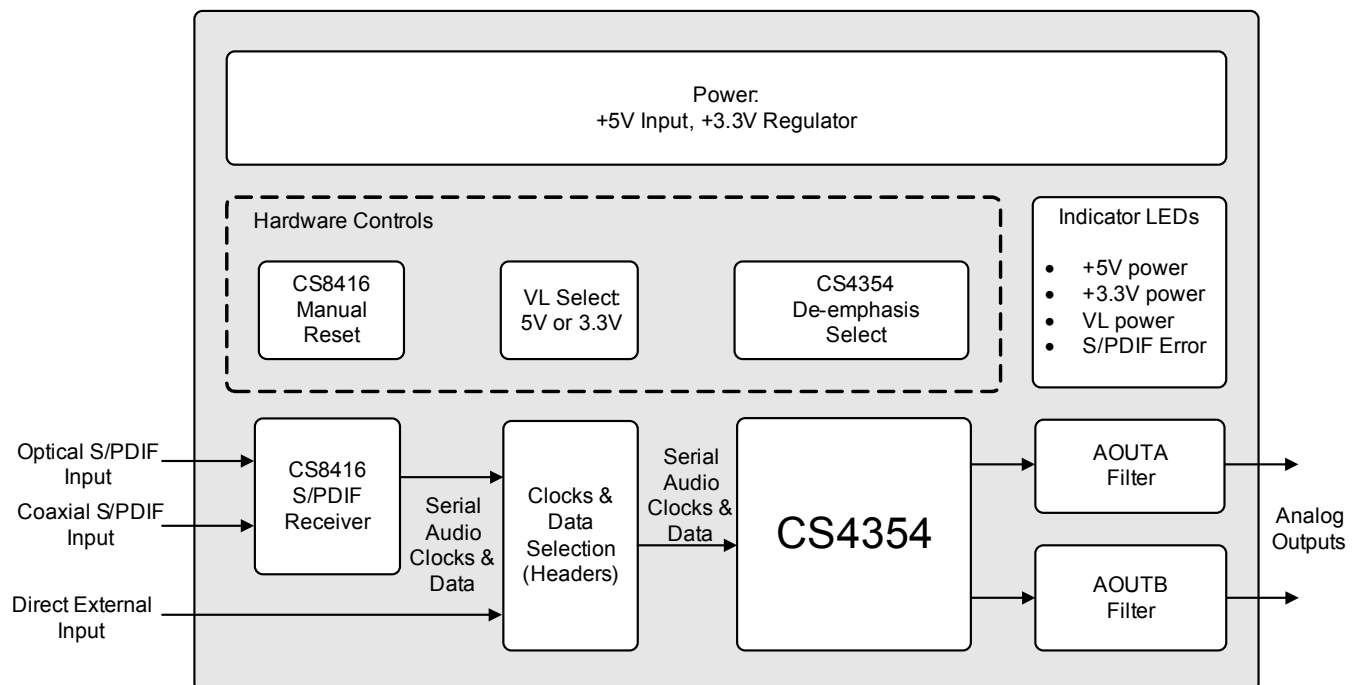

TABLE OF CONTENTS

1. THE CDB4354 SYSTEM	3
2. BOARD CONNECTIONS AND SETTINGS	5
3. SCHEMATICS AND LAYOUT	7
4. REVISION HISTORY	11

LIST OF FIGURES

Figure 1. CDB4354 Factory Default Jumper Settings	6
Figure 2. System Block Diagram and Signal Flow	7
Figure 3. CS8416 and CS4354	8
Figure 4. Power	9
Figure 5. Silkscreen Top	10
Figure 6. Top Side	10
Figure 6. Top Side	10
Figure 7. Bottom Side	10

LIST OF TABLES

Table 1. System Connections	5
Table 2. CDB4354 Jumper Pin Block Settings	5
Table 3. LED Information	5

1. THE CDB4354 SYSTEM

The CDB4354 is a dedicated platform for evaluating the CS4354. The CS8416 digital audio interface receiver provides an easy interface to digital audio signal sources, including the majority of digital audio test equipment. The evaluation board also allows the user to supply external PCM clocks and data directly to the CS4354 through a header block for system development. In addition, hardware controls are available to test board and CS4354-specific features.

The CDB4354 system block diagram and signal flow is shown in [Figure 2](#). The CDB4354 schematics are shown in [Figures 3](#) and [4](#).

1.1 CS4354 Digital-to-Analog Converter

The CS4354 is a 24-bit, 2 V_{RMS} ground-centered output digital-to-analog converter with 101 dB (A-weighted) dynamic range. A complete description of the CS4354 is included in the CS4354 datasheet.

1.2 CS8416 Digital Audio Receiver

The system receives and decodes the standard S/PDIF data format using a CS8416 Digital Audio Receiver. The outputs of the CS8416 are standard PCM clocks and data: 256 Fs master clock, serial bit clock, left-right clock, and serial data. The operation of the CS8416 and a discussion of the digital audio interface is included in the CS8416 datasheet.

The evaluation board has been designed such that the active input can be either optical (OPT1) or coaxial (J16). However, both inputs cannot be driven simultaneously.

1.3 Input for Serial Audio Clocks and Data

By default, the shunts on header block J6 are placed across columns 1 and 2, marked “SPDIF_RX”, which routes the serial audio clocks and data from the CS8416 to the CS4354. This makes the S/PDIF inputs on the evaluation board the default inputs. However, the user may remove these shunts and connect an external source to columns 2 and 3 of header block J6, marked “EXT,” via a ribbon cable. Column 3 of J6 are GND pins to maintain signal ground integrity when using external clocks and data.

Signals input to header J6 must be at the same voltage level as the VL supply on the evaluation board. When using the S/PDIF inputs on the evaluation board with columns 1 and 2 of J6 shunted, this requirement is always met and thus requires no precaution on the user’s part.

Please see the CS4354 datasheet for more information on clocking data into the CS4354.

Note: If the VL supply is set to a low voltage level ($VL < 1.8$ V), termination resistors may need to be added to the J6 header signals to match the source and transmission-line impedances that are driving the header. This may be accomplished by soldering resistors across the rows of J6 on the back of the evaluation board.

1.4 Power Supply Circuitry

Power is supplied to the evaluation board by two binding posts, J2 (+5 V) and GND. The allowable input voltage range for J2 is 4.75 V to 5.25 V. The VA supply for the CS4354 is sourced directly from the +5 V supply. The VL supply can be sourced from either the +5 V supply or a +3.3 V regulated version, selected using J12. Furthermore, the user can have full control over the VL supply voltage by removing the shunt from J12, and connecting an external supply to pin 2 of J12. When using the S/PDIF inputs, the allowable voltage range for pin 2 of J12 is 3.13 V to 5.25 V. When using external serial audio clocks and data, the allowable voltage range for pin 2 of J12 is 1.4 V to 5.25 V.

Power consumption of the CS4354 can be calculated with the measured voltage drop at J4 and J5 when the shunts are removed.

WARNING: Refer to the CS4354 datasheet for maximum allowable voltages levels. Operation outside of this range can cause permanent damage to the device.

1.5 Grounding and Power Supply Decoupling

As with any high-performance converter, the CS4354 requires careful attention to power supply and grounding arrangements to optimize performance. [Figure 3](#) details the connections to the CS4354 and [Figures 5](#), [6](#), and [7](#) show the component placement and top and bottom layout. The charge-pump and decoupling capacitors are located as close to the CS4354 as possible.

1.6 Hardware Control

The CDB4354 includes several shunable jumper pin blocks to test CS4354-specific and board features, such as:

- De-emphasis and Internal Serial Clock select for the CS4354
- Manual reset for the CS8416
- +5 V/+3.3 V select for the VL supply

Please use [Table 2](#) as a guide to the possible configurations for these controls.

1.7 Analog Output Filtering

The analog output filter circuitry on the CDB4354 has been designed according to the CS4354 datasheet. This circuit is a first order resistor-capacitor low pass filter with values 470 Ω /2.2 nF, respectively, which sets the -3 dB pole at 154 kHz. The resulting filter keeps signal attenuation below 0.1 dB at 20 kHz while providing sufficient filtering for noise outside the audio band.

2. BOARD CONNECTIONS AND SETTINGS

Board connections and settings are shown in [Table 1](#) and [Table 2](#) below.

CONNECTOR	INPUT/OUTPUT	SIGNAL PRESENT
+5 V - J2	Input	+3.3 V power for the evaluation board
GND - J1	Input	Ground connection from power supply
S/PDIF INPUT - J16	Input	Digital audio interface input via coaxial cable
S/PDIF INPUT - OPT1	Input	Digital audio interface input via optical cable
Serial Audio Header Pin Block - J6	Input	Input for master, serial, left/right clocks and serial data (MCLK, SCLK, LRCK, and SDIN) - direct to CS4354
AOUTA - J7 AOUTB - J8	Output	RCA line-level analog outputs

Table 1. System Connections

JUMPER PIN BLOCK	PURPOSE	POSITION	FUNCTION SELECTED
J12	Selects source of voltage for the VL supply	pins [1, 2] shunted *pins [2,3] shunted not shunted	Voltage source is +5 V Voltage source is +3.3 V Voltage source is pin 2 of J12
J4	Current measure for VL	*shunted not shunted	When shunt is removed, the voltage can be measured across a fixed resistance R2 to determine current.
J5	Current measure for VA	*shunted not shunted	When shunt is removed, the voltage can be measured across a fixed resistance R3 to determine current.
J9	CS8416 Manual Reset	shunted *not shunted	CS8416 is held in reset as long as J9 is shunted CS8416 uses the on-board automatic reset
J3	CS4354 De-emphasis and Internal Serial Clock Mode Select	pins [1, 2] shunted *pins [2, 3] shunted not shunted	Internal Serial Clock Mode, De-emphasis enabled External Serial Clock Mode, De-emphasis disabled Internal Serial Clock Mode, De-emphasis disabled

Table 2. CDB4354 Jumper Pin Block Settings

LED	FUNCTION
+3.3V - D1	LED is illuminated when the +3.3 V supply is on (+3.3V is derived from the +5V supply by an on-board regulator)
+5V - D2	LED is illuminated when the +5 V supply is on
VL - D4	LED is illuminated when the VL supply is on (either by the onboard +3.3 V, +5 V or external supply)
S/PDIF - D10	LED is illuminated when the CS8416 reports a Receiver Error. See the CS8416 datasheet for a full description of the error reporting functionality.

Table 3. LED Information

Note: All settings denoted by an asterisk (*) are the Factory Default Settings.

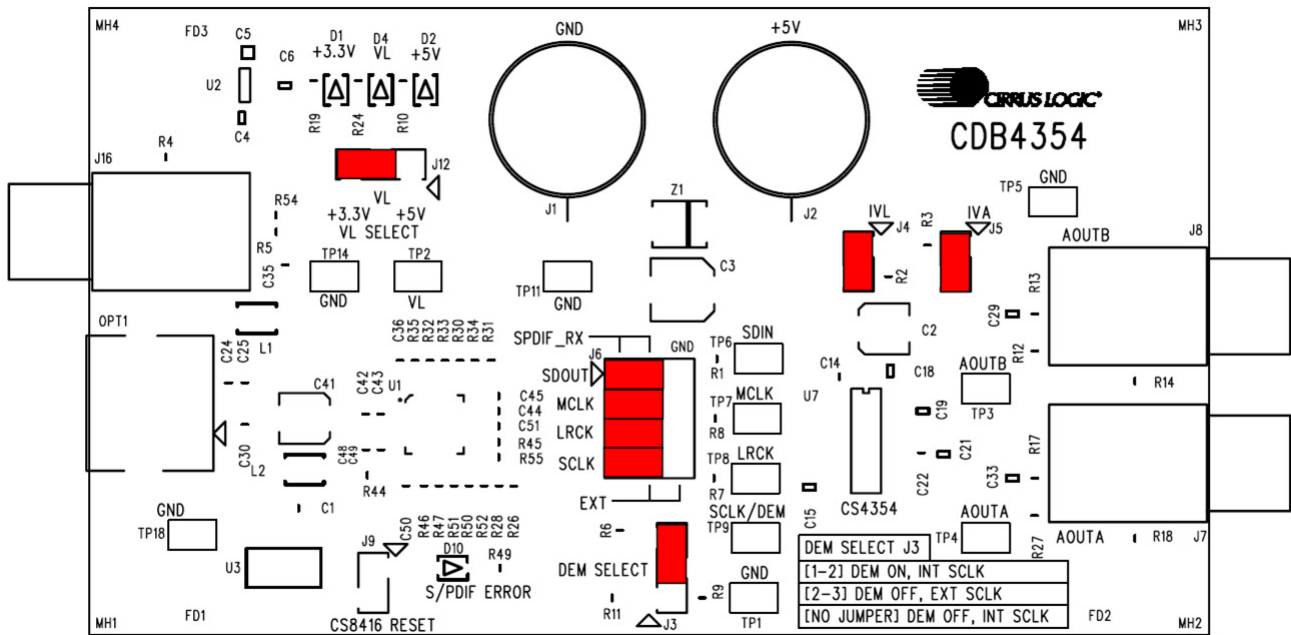

Figure 1. CDB4354 Factory Default Jumper Settings

3. SCHEMATICS AND LAYOUT

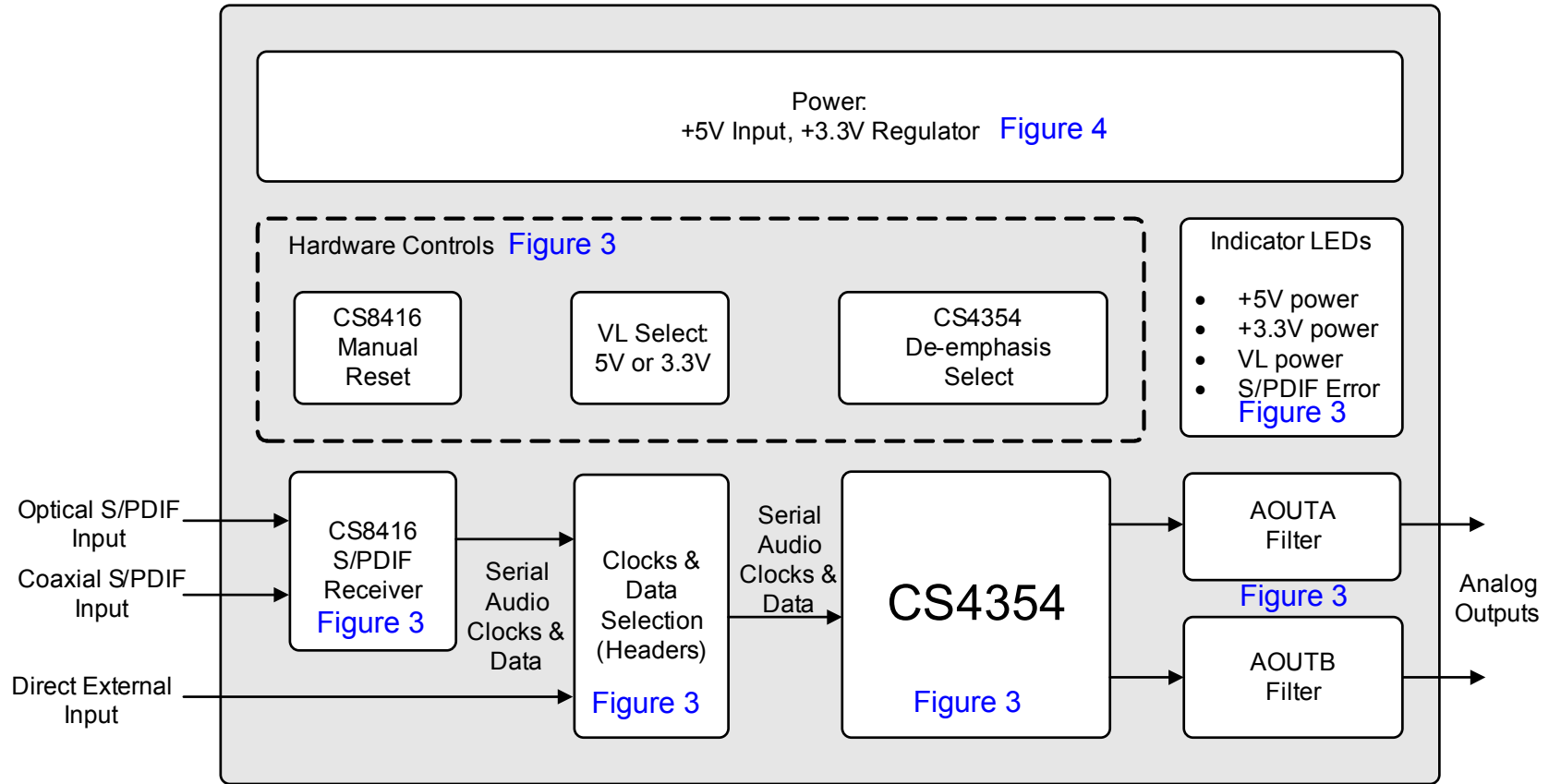

Figure 2. System Block Diagram and Signal Flow



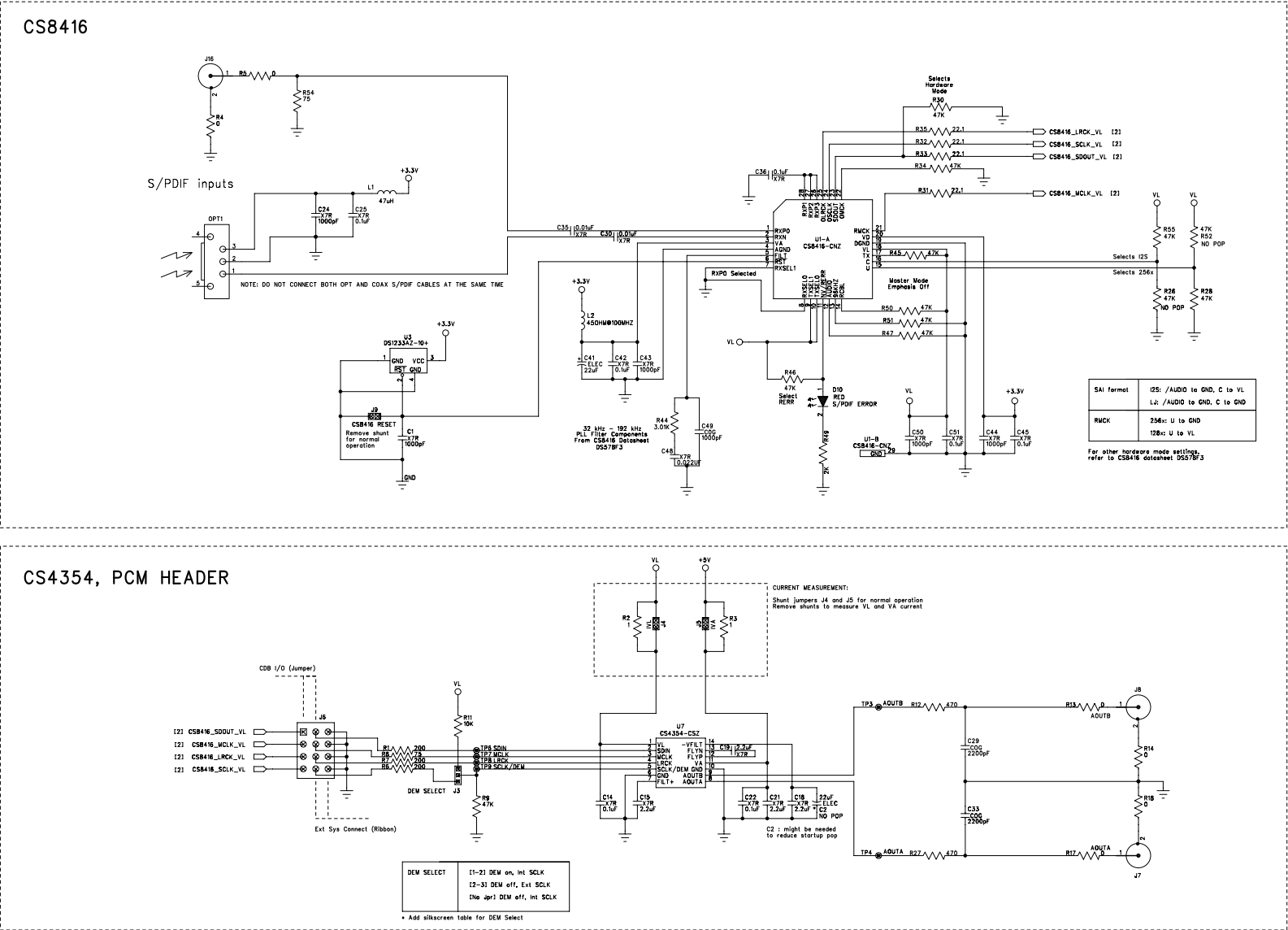
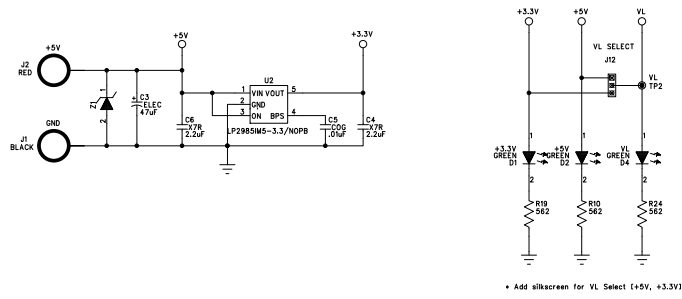

Figure 3. CS8416 and CS4354

POWER



NOTES

Silkscreen: Place Text Next to Appropriate Header or Connector
 Relevant Components Have Silkscreen Attributes

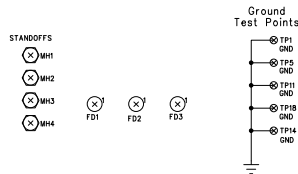

RELATED DOCUMENTS AND AUXILIARY HARDWARE:

- ASSY DWG- 603-00392-Z1
- EBR DWG- 240-00392-Z1
- SCH DWG- 600-00392-Z1
- SHUNT_2P- 15-29-1025
- SCREW-PHILPS-4-40THR-PH-5/16-L PMS55 440 0031 PH
- WIRE BINDING POST L-15X25TX29T_TYPE_E_

Figure 4. Power

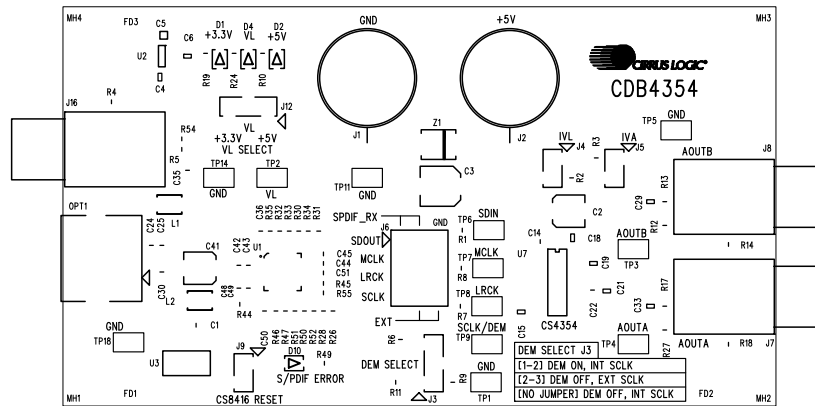
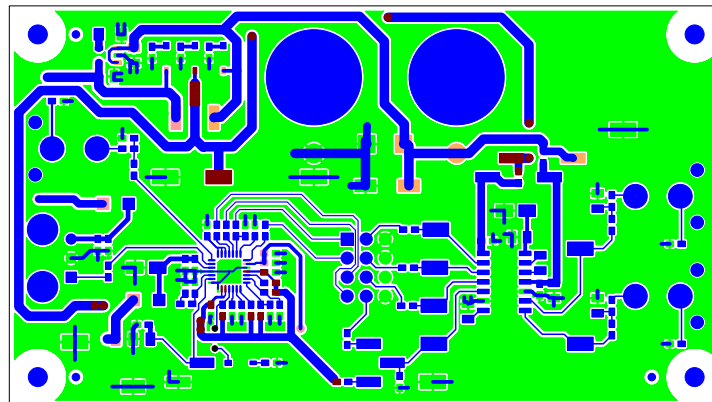
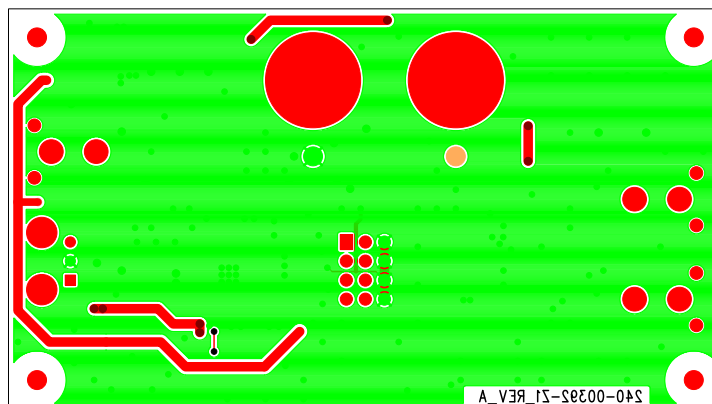

Figure 5. Silkscreen Top

Figure 6. Top Side

Figure 7. Bottom Side

Note: Figure 5, 6, and 7 show the actual size of the CDB4354 if this document is printed on letter-sized paper.

4. REVISION HISTORY

Release	Changes
DB1	Initial Release

Contacting Cirrus Logic Support

For all product questions and inquiries, contact a Cirrus Logic Sales Representative.

To find the one nearest you, go to www.cirrus.com.

IMPORTANT NOTICE

Cirrus Logic, Inc. and its subsidiaries ("Cirrus") believe that the information contained in this document is accurate and reliable. However, the information is subject to change without notice and is provided "AS IS" without warranty of any kind (express or implied). Customers are advised to obtain the latest version of relevant information to verify, before placing orders, that information being relied on is current and complete. All products are sold subject to the terms and conditions of sale supplied at the time of order acknowledgment, including those pertaining to warranty, indemnification, and limitation of liability. No responsibility is assumed by Cirrus for the use of this information, including use of this information as the basis for manufacture or sale of any items, or for infringement of patents or other rights of third parties. This document is the property of Cirrus and by furnishing this information, Cirrus grants no license, express or implied under any patents, mask work rights, copyrights, trademarks, trade secrets or other intellectual property rights. Cirrus owns the copyrights associated with the information contained herein and gives consent for copies to be made of the information only for use within your organization with respect to Cirrus integrated circuits or other products of Cirrus. This consent does not extend to other copying such as copying for general distribution, advertising or promotional purposes, or for creating any work for resale.

CERTAIN APPLICATIONS USING SEMICONDUCTOR PRODUCTS MAY INVOLVE POTENTIAL RISKS OF DEATH, PERSONAL INJURY, OR SEVERE PROPERTY OR ENVIRONMENTAL DAMAGE ("CRITICAL APPLICATIONS"). CIRRUS PRODUCTS ARE NOT DESIGNED, AUTHORIZED OR WARRANTED FOR USE IN PRODUCTS SURGICALLY IMPLANTED INTO THE BODY, AUTOMOTIVE SAFETY OR SECURITY DEVICES, LIFE SUPPORT PRODUCTS OR OTHER CRITICAL APPLICATIONS. INCLUSION OF CIRRUS PRODUCTS IN SUCH APPLICATIONS IS UNDERSTOOD TO BE FULLY AT THE CUSTOMER'S RISK AND CIRRUS DISCLAIMS AND MAKES NO WARRANTY, EXPRESS, STATUTORY OR IMPLIED, INCLUDING THE IMPLIED WARRANTIES OF MERCHANTABILITY AND FITNESS FOR PARTICULAR PURPOSE, WITH REGARD TO ANY CIRRUS PRODUCT THAT IS USED IN SUCH A MANNER. IF THE CUSTOMER OR CUSTOMER'S CUSTOMER USES OR PERMITS THE USE OF CIRRUS PRODUCTS IN CRITICAL APPLICATIONS, CUSTOMER AGREES, BY SUCH USE, TO FULLY INDEMNIFY CIRRUS, ITS OFFICERS, DIRECTORS, EMPLOYEES, DISTRIBUTORS AND OTHER AGENTS FROM ANY AND ALL LIABILITY, INCLUDING ATTORNEYS' FEES AND COSTS, THAT MAY RESULT FROM OR ARISE IN CONNECTION WITH THESE USES.

Cirrus Logic, Cirrus, and the Cirrus Logic logo designs are trademarks of Cirrus Logic, Inc. All other brand and product names in this document may be trademarks or service marks of their respective owners.

AMEYA360

Components Supply Platform

Authorized Distribution Brand :



Website :

Welcome to visit www.ameya360.com

Contact Us :

➤ Address :

401 Building No.5, JiuGe Business Center, Lane 2301, Yishan Rd
Minhang District, Shanghai , China

➤ Sales :

Direct +86 (21) 6401-6692

Email amall@ameya360.com

QQ 800077892

Skype [ameyasales1](#) [ameyasales2](#)

➤ Customer Service :

Email service@ameya360.com

➤ Partnership :

Tel +86 (21) 64016692-8333

Email mkt@ameya360.com