

FDMS3600S

PowerTrench® Power Stage

25 V Asymmetric Dual N-Channel MOSFET

Features

Q1: N-Channel

- Max $r_{DS(on)}$ = 5.6 m Ω at $V_{GS} = 10$ V, $I_D = 15$ A
- Max $r_{DS(on)}$ = 8.1 m Ω at $V_{GS} = 4.5$ V, $I_D = 14$ A

Q2: N-Channel

- Max $r_{DS(on)}$ = 1.6 m Ω at $V_{GS} = 10$ V, $I_D = 30$ A
- Max $r_{DS(on)}$ = 2.4 m Ω at $V_{GS} = 4.5$ V, $I_D = 25$ A
- Low inductance packaging shortens rise/fall times, resulting in lower switching losses
- MOSFET integration enables optimum layout for lower circuit inductance and reduced switch node ringing
- RoHS Compliant



General Description

This device includes two specialized N-Channel MOSFETs in a dual PQFN package. The switch node has been internally connected to enable easy placement and routing of synchronous buck converters. The control MOSFET (Q1) and synchronous SyncFET (Q2) have been designed to provide optimal power efficiency.

Applications

- Computing
- Communications
- General Purpose Point of Load
- Notebook VCORE
- Server

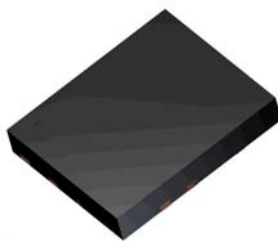

Top

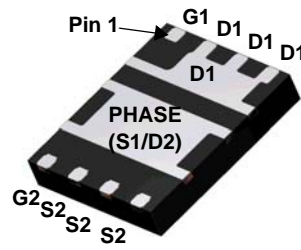

Bottom

Power 56

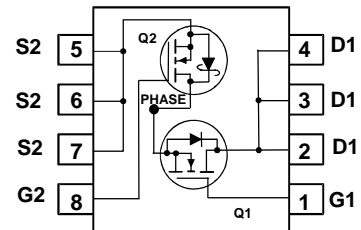

MOSFET Maximum Ratings $T_A = 25$ °C unless otherwise noted

Symbol	Parameter	Q1	Q2	Units
V_{DS}	Drain to Source Voltage	25	25	V
V_{GS}	Gate to Source Voltage (Note 3)	± 20	± 20	V
I_D	Drain Current -Continuous (Package limited) $T_C = 25$ °C	30	40	A
	-Continuous (Silicon limited) $T_C = 25$ °C	65	155	
	-Continuous $T_A = 25$ °C	15 ^{1a}	30 ^{1b}	
	-Pulsed	40	100	
E_{AS}	Single Pulse Avalanche Energy	50 ⁴	200 ⁵	mJ
P_D	Power Dissipation for Single Operation $T_A = 25$ °C	2.2 ^{1a}	2.5 ^{1b}	W
	Power Dissipation for Single Operation $T_A = 25$ °C	1.0 ^{1c}	1.0 ^{1d}	
T_J, T_{STG}	Operating and Storage Junction Temperature Range	-55 to +150		°C

Thermal Characteristics

$R_{\theta JA}$	Thermal Resistance, Junction to Ambient	57 ^{1a}	50 ^{1b}	°C/W
$R_{\theta JA}$	Thermal Resistance, Junction to Ambient	125 ^{1c}	120 ^{1d}	
$R_{\theta JC}$	Thermal Resistance, Junction to Case	3.5	2	

Package Marking and Ordering Information

Device Marking	Device	Package	Reel Size	Tape Width	Quantity
220A N90C	FDMS3600S	Power 56	13 "	12 mm	3000 units

Electrical Characteristics $T_J = 25\text{ }^\circ\text{C}$ unless otherwise noted

Symbol	Parameter	Test Conditions	Type	Min	Typ	Max	Units
--------	-----------	-----------------	------	-----	-----	-----	-------

Off Characteristics

BV_{DSS}	Drain to Source Breakdown Voltage	$I_D = 250\text{ }\mu\text{A}$, $V_{GS} = 0\text{ V}$ $I_D = 1\text{ mA}$, $V_{GS} = 0\text{ V}$	Q1 Q2	25 25			V
$\frac{\Delta BV_{DSS}}{\Delta T_J}$	Breakdown Voltage Temperature Coefficient	$I_D = 250\text{ }\mu\text{A}$, referenced to $25\text{ }^\circ\text{C}$ $I_D = 10\text{ mA}$, referenced to $25\text{ }^\circ\text{C}$	Q1 Q2		20 18		mV/ $^\circ\text{C}$
I_{DSS}	Zero Gate Voltage Drain Current	$V_{DS} = 20\text{ V}$, $V_{GS} = 0\text{ V}$	Q1 Q2			1 500	μA μA
I_{GSS}	Gate to Source Leakage Current, Forward	$V_{GS} = 20\text{ V}$, $V_{DS} = 0\text{ V}$	Q1 Q2			100 100	nA nA

On Characteristics

$V_{GS(th)}$	Gate to Source Threshold Voltage	$V_{GS} = V_{DS}$, $I_D = 250\text{ }\mu\text{A}$ $V_{GS} = V_{DS}$, $I_D = 1\text{ mA}$	Q1 Q2	1.1 1	1.8 1.5	2.7 3	V
$\frac{\Delta V_{GS(th)}}{\Delta T_J}$	Gate to Source Threshold Voltage Temperature Coefficient	$I_D = 250\text{ }\mu\text{A}$, referenced to $25\text{ }^\circ\text{C}$ $I_D = 10\text{ mA}$, referenced to $25\text{ }^\circ\text{C}$	Q1 Q2		-6 -5		mV/ $^\circ\text{C}$
$r_{DS(on)}$	Drain to Source On Resistance	$V_{GS} = 10\text{ V}$, $I_D = 15\text{ A}$ $V_{GS} = 4.5\text{ V}$, $I_D = 14\text{ A}$ $V_{GS} = 10\text{ V}$, $I_D = 15\text{ A}$, $T_J = 125\text{ }^\circ\text{C}$	Q1		4.3 6.2 5.9	5.6 8.1 8.7	m Ω
		$V_{GS} = 10\text{ V}$, $I_D = 30\text{ A}$ $V_{GS} = 4.5\text{ V}$, $I_D = 25\text{ A}$ $V_{GS} = 10\text{ V}$, $I_D = 30\text{ A}$, $T_J = 125\text{ }^\circ\text{C}$	Q2		1.3 1.7 1.8	1.6 2.4 2.7	
g_{FS}	Forward Transconductance	$V_{DS} = 5\text{ V}$, $I_D = 15\text{ A}$ $V_{DS} = 5\text{ V}$, $I_D = 30\text{ A}$	Q1 Q2		67 171		S

Dynamic Characteristics

C_{iss}	Input Capacitance	Q1: $V_{DS} = 13\text{ V}$, $V_{GS} = 0\text{ V}$, $f = 1\text{ MHz}$	Q1 Q2		1264 4042	1680 5375	pF
C_{oss}	Output Capacitance	Q2: $V_{DS} = 13\text{ V}$, $V_{GS} = 0\text{ V}$, $f = 1\text{ MHz}$	Q1 Q2		340 1207	450 1605	pF
C_{rss}	Reverse Transfer Capacitance	$V_{DS} = 13\text{ V}$, $V_{GS} = 0\text{ V}$, $f = 1\text{ MHz}$	Q1 Q2		58 148	90 220	pF
R_g	Gate Resistance		Q1 Q2	0.2 0.2	0.6 0.9	2 3	Ω

Switching Characteristics

$t_{d(on)}$	Turn-On Delay Time	Q1: $V_{DD} = 13\text{ V}$, $I_D = 15\text{ A}$, $R_{GEN} = 6\text{ }\Omega$	Q1 Q2		7.9 13	16 23	ns	
t_r	Rise Time		Q1 Q2		2 5.3	10 11	ns	
$t_{d(off)}$	Turn-Off Delay Time	Q2: $V_{DD} = 13\text{ V}$, $I_D = 30\text{ A}$, $R_{GEN} = 6\text{ }\Omega$	Q1 Q2		19 38	34 60	ns	
t_f	Fall Time		Q1 Q2		1.8 3.9	10 10	ns	
Q_g	Total Gate Charge	$V_{GS} = 0\text{ V}$ to 10 V	Q1 $V_{DD} = 13\text{ V}$, $I_D = 15\text{ A}$	Q1 Q2		19 59	27 82	nC
				Q1 Q2		9 27	13 38	nC
Q_{gs}	Gate to Source Gate Charge	$V_{GS} = 0\text{ V}$ to 4.5 V	Q2 $V_{DD} = 13\text{ V}$, $I_D = 30\text{ A}$	Q1 Q2		3.9 11		nC
Q_{gd}	Gate to Drain "Miller" Charge			Q1 Q2		2.4 5.8		nC

Electrical Characteristics $T_J = 25\text{ }^\circ\text{C}$ unless otherwise noted

Symbol	Parameter	Test Conditions	Type	Min	Typ	Max	Units
--------	-----------	-----------------	------	-----	-----	-----	-------

Drain-Source Diode Characteristics

V_{SD}	Source to Drain Diode Forward Voltage	$V_{GS} = 0\text{ V}, I_S = 15\text{ A}$ (Note 2)	Q1		0.8	1.2	V
		$V_{GS} = 0\text{ V}, I_S = 30\text{ A}$ (Note 2)	Q2		0.8	1.2	
t_{rr}	Reverse Recovery Time	Q1 $I_F = 15\text{ A}, di/dt = 100\text{ A}/\mu\text{s}$	Q1		21	34	ns
			Q2		32	51	
Q_{rr}	Reverse Recovery Charge	Q2 $I_F = 30\text{ A}, di/dt = 300\text{ A}/\mu\text{s}$	Q1		6.6	13	nC
			Q2		36	58	

Notes:

1: $R_{\theta JA}$ is determined with the device mounted on a 1 in² pad 2 oz copper pad on a 1.5 x 1.5 in. board of FR-4 material. $R_{\theta JC}$ is guaranteed by design while $R_{\theta CA}$ is determined by the user's board design.

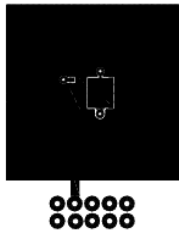

a. 57 °C/W when mounted on a 1 in² pad of 2 oz copper



b. 50 °C/W when mounted on a 1 in² pad of 2 oz copper

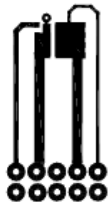

c. 125 °C/W when mounted on a minimum pad of 2 oz copper



d. 120 °C/W when mounted on a minimum pad of 2 oz copper

2: Pulse Test: Pulse Width < 300 μs, Duty cycle < 2.0%.

3: As an N-ch device, the negative Vgs rating is for low duty cycle pulse occurrence only. No continuous rating is implied.

4: E_{AS} of 50 mJ is based on starting $T_J = 25\text{ }^\circ\text{C}$; N-ch: $L = 1\text{ mH}, I_{AS} = 10\text{ A}, V_{DD} = 23\text{ V}, V_{GS} = 10\text{ V}$. 100% test at $L=0.3\text{ mH}, I_{AS} = 15\text{ A}$.

5: E_{AS} of 200 mJ is based on starting $T_J = 25\text{ }^\circ\text{C}$; N-ch: $L = 1\text{ mH}, I_{AS} = 20\text{ A}, V_{DD} = 23\text{ V}, V_{GS} = 10\text{ V}$. 100% test at $L=0.3\text{ mH}, I_{AS} = 30\text{ A}$.

Typical Characteristics (Q1 N-Channel) $T_J = 25\text{ }^\circ\text{C}$ unless otherwise noted

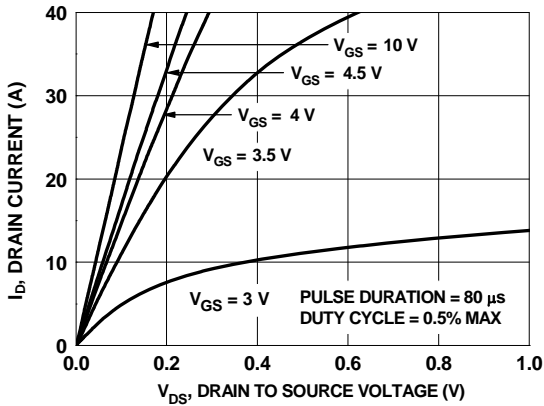

Figure 1. On Region Characteristics

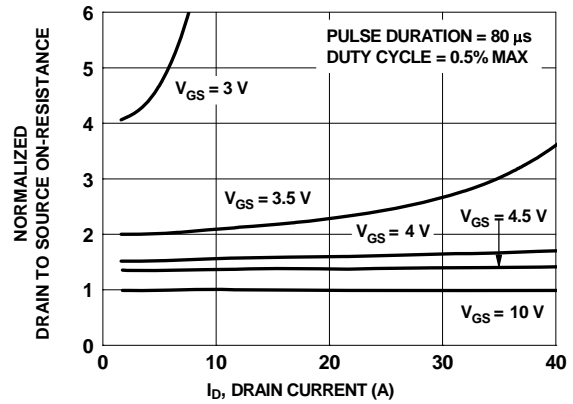

Figure 2. Normalized On-Resistance vs Drain Current and Gate Voltage

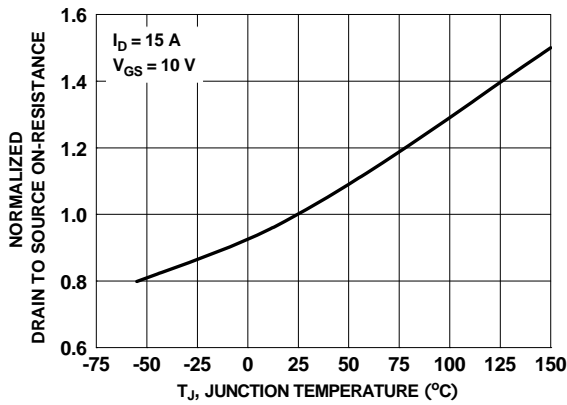

Figure 3. Normalized On Resistance vs Junction Temperature

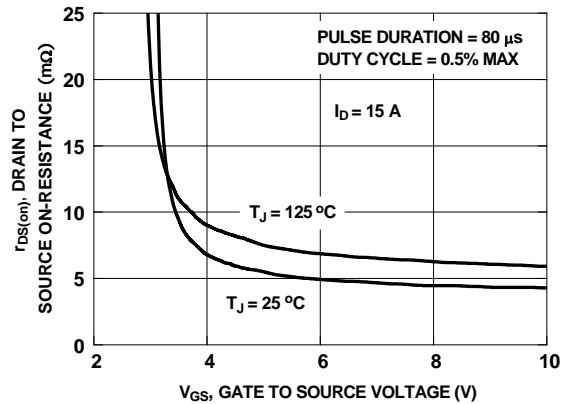

Figure 4. On-Resistance vs Gate to Source Voltage

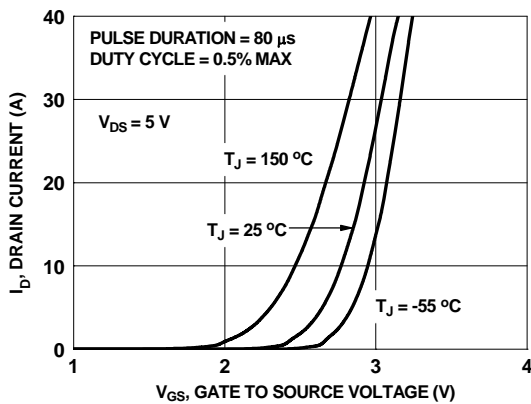

Figure 5. Transfer Characteristics

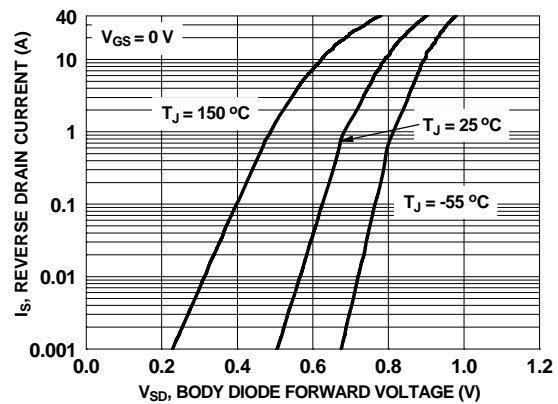

Figure 6. Source to Drain Diode Forward Voltage vs Source Current

Typical Characteristics (Q1 N-Channel) $T_J = 25\text{ }^\circ\text{C}$ unless otherwise noted

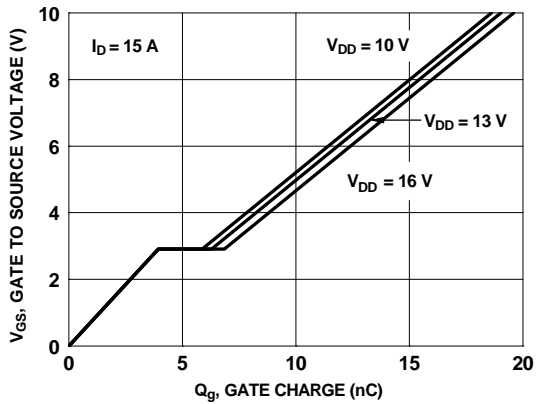

Figure 7. Gate Charge Characteristics

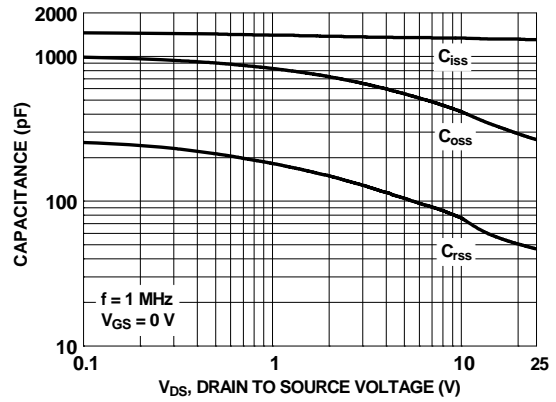

Figure 8. Capacitance vs Drain to Source Voltage

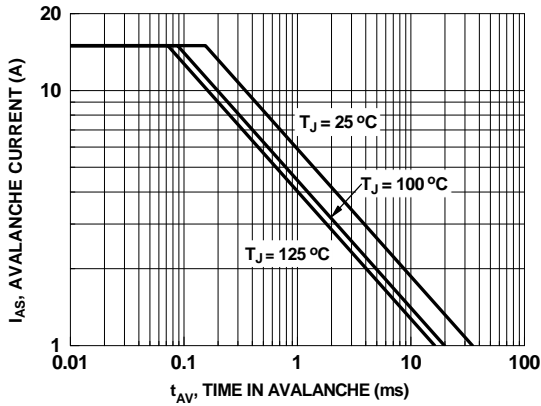

Figure 9. Unclamped Inductive Switching Capability

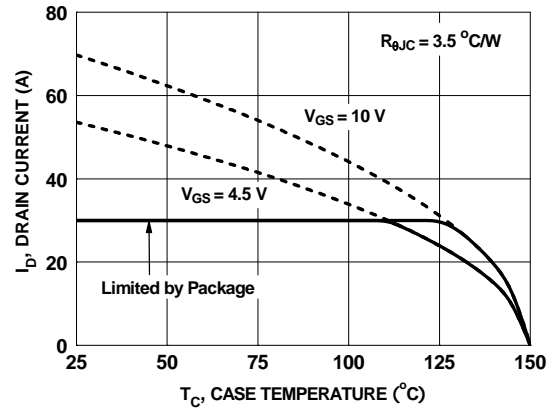

Figure 10. Maximum Continuous Drain Current vs Case Temperature

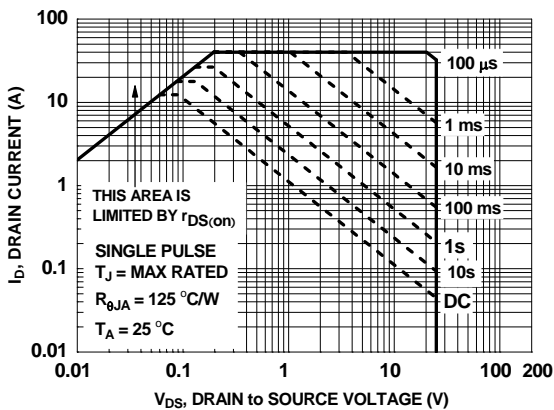

Figure 11. Forward Bias Safe Operating Area

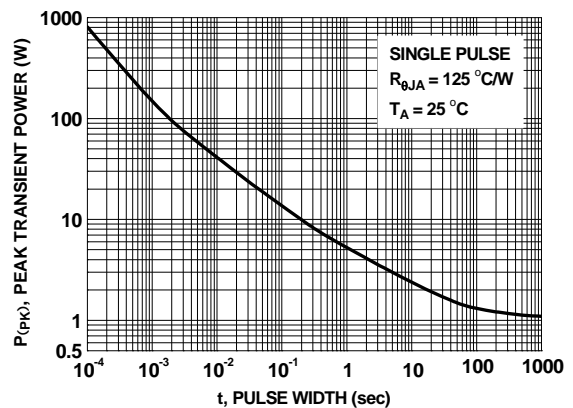

Figure 12. Single Pulse Maximum Power Dissipation

Typical Characteristics (Q1 N-Channel) $T_J = 25\text{ }^\circ\text{C}$ unless otherwise noted

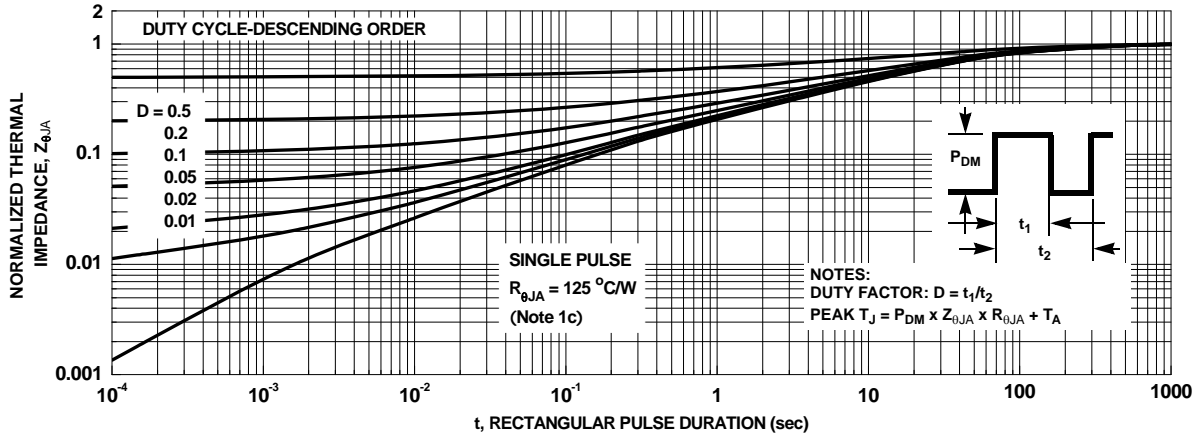

Figure 13. Junction-to-Ambient Transient Thermal Response Curve

Typical Characteristics (Q2 N-Channel) $T_J = 25^\circ\text{C}$ unless otherwise noted

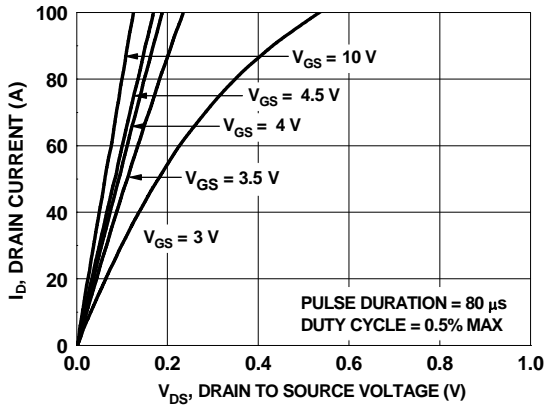

Figure 14. On-Region Characteristics

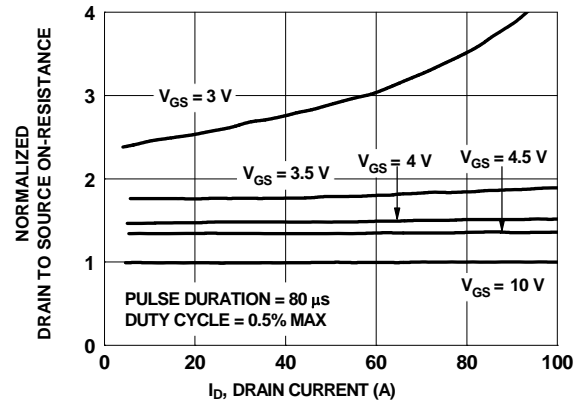

Figure 15. Normalized on-Resistance vs Drain Current and Gate Voltage

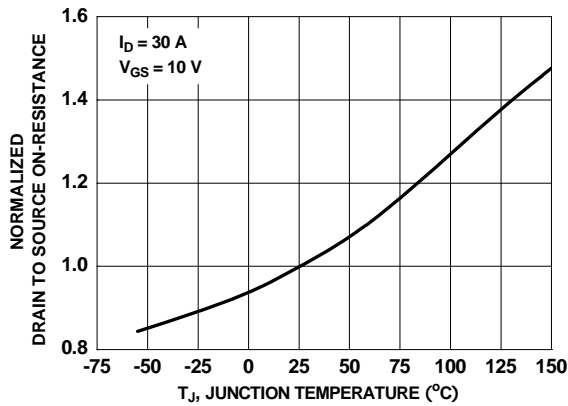

Figure 16. Normalized On-Resistance vs Junction Temperature

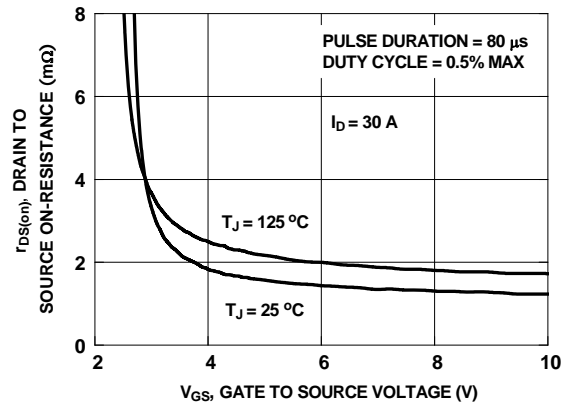

Figure 17. On-Resistance vs Gate to Source Voltage

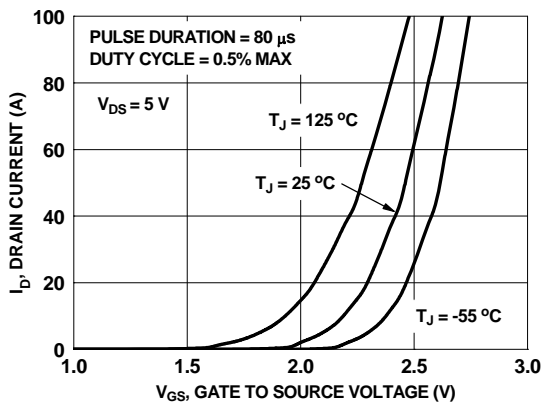

Figure 18. Transfer Characteristics

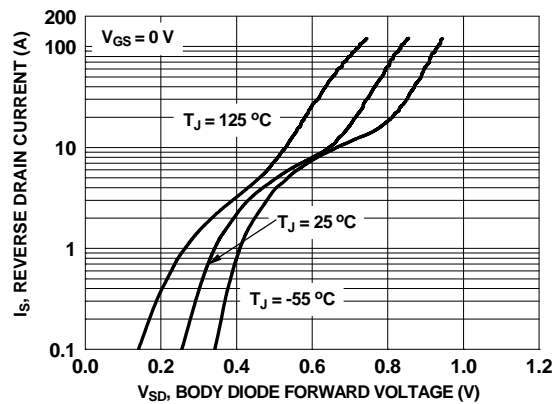

Figure 19. Source to Drain Diode Forward Voltage vs Source Current

Typical Characteristics (Q2 N-Channel) $T_J = 25\text{ }^\circ\text{C}$ unless otherwise noted

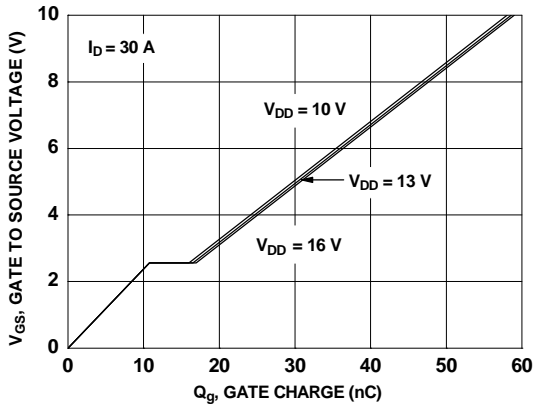

Figure 20. Gate Charge Characteristics

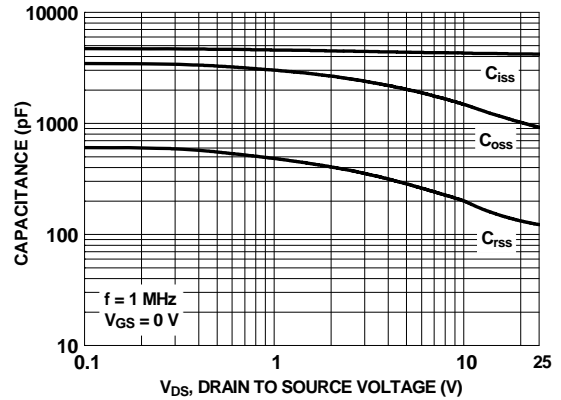

Figure 21. Capacitance vs Drain to Source Voltage

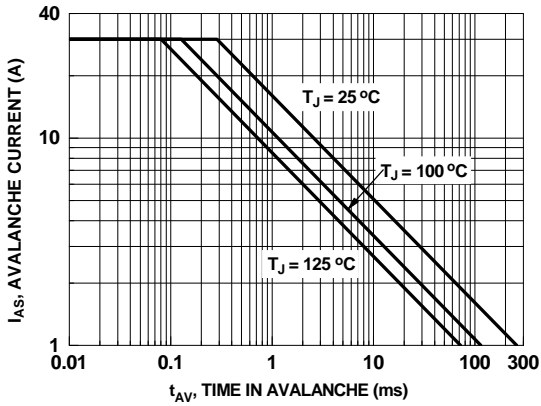

Figure 22. Unclamped Inductive Switching Capability

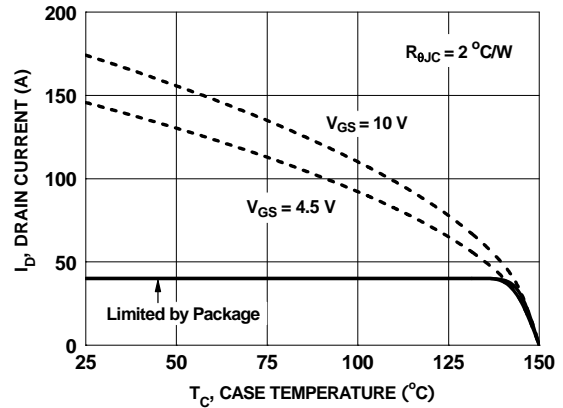

Figure 23. Maximum Continuous Drain Current vs Case Temperature

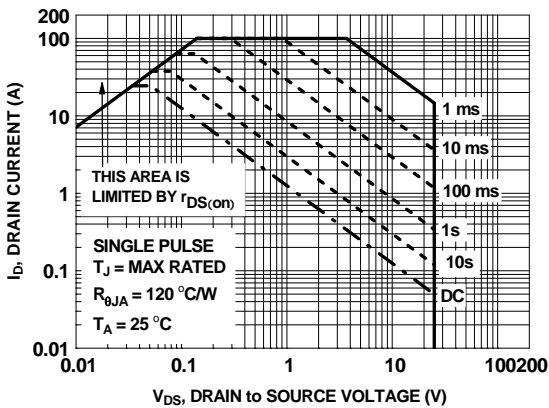

Figure 24. Forward Bias Safe Operating Area

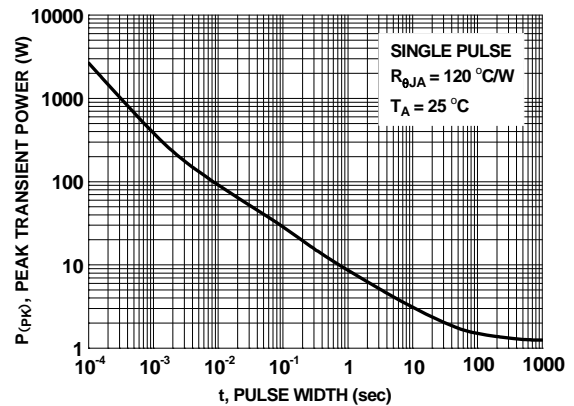

Figure 25. Single Pulse Maximum Power Dissipation

Typical Characteristics (Q2 N-Channel) $T_J = 25\text{ }^\circ\text{C}$ unless otherwise noted

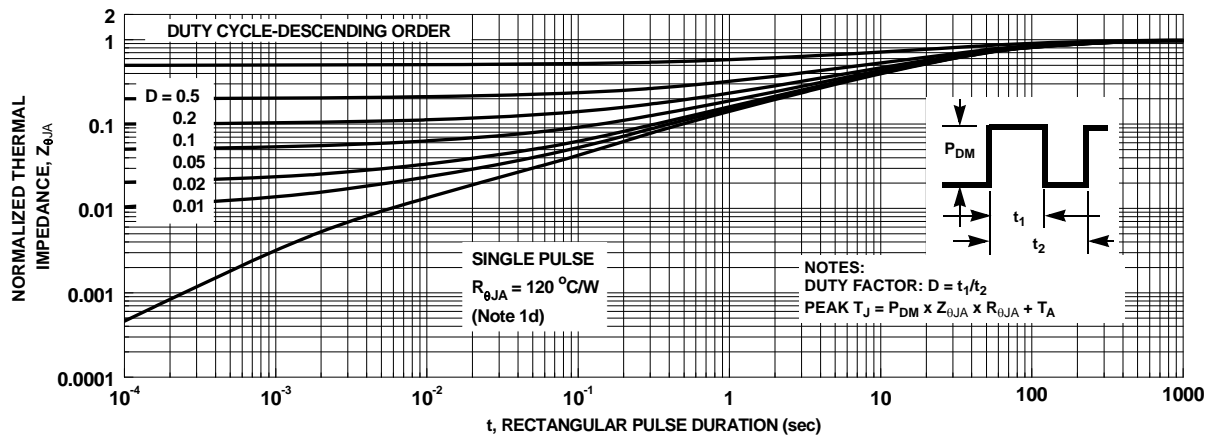

Figure 26. Junction-to-Ambient Transient Thermal Response Curve

Typical Characteristics (continued)

SyncFET Schottky body diode Characteristics

Fairchild's SyncFET process embeds a Schottky diode in parallel with PowerTrench MOSFET. This diode exhibits similar characteristics to a discrete external Schottky diode in parallel with a MOSFET. Figure 27 shows the reverse recovery characteristic of the FDMS3600S.

Schottky barrier diodes exhibit significant leakage at high temperature and high reverse voltage. This will increase the power in the device.

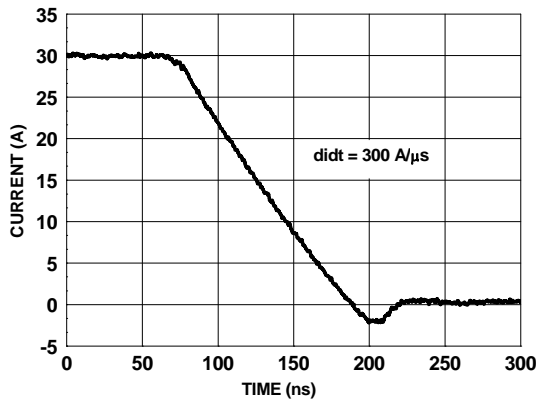

Figure 27. FDMS3600S SyncFET body diode reverse recovery characteristic

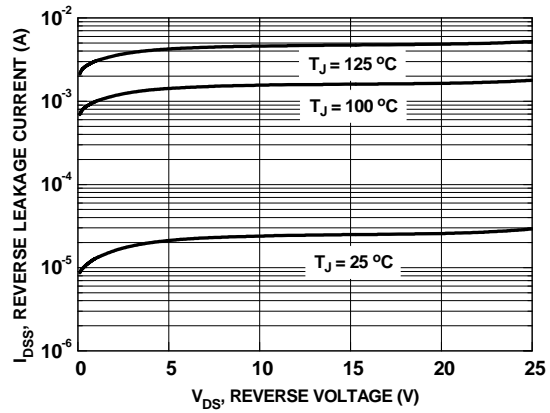

Figure 28. SyncFET body diode reverse leakage versus drain-source voltage

Application Information

1. Switch Node Ringing Suppression

Fairchild's Power Stage products incorporate a proprietary design* that minimizes the peak overshoot, ringing voltage on the switch node (PHASE) without the need of any external snubbing components in a buck converter. As shown in the figure 29, the Power Stage solution rings significantly less than competitor solutions under the same set of test conditions.

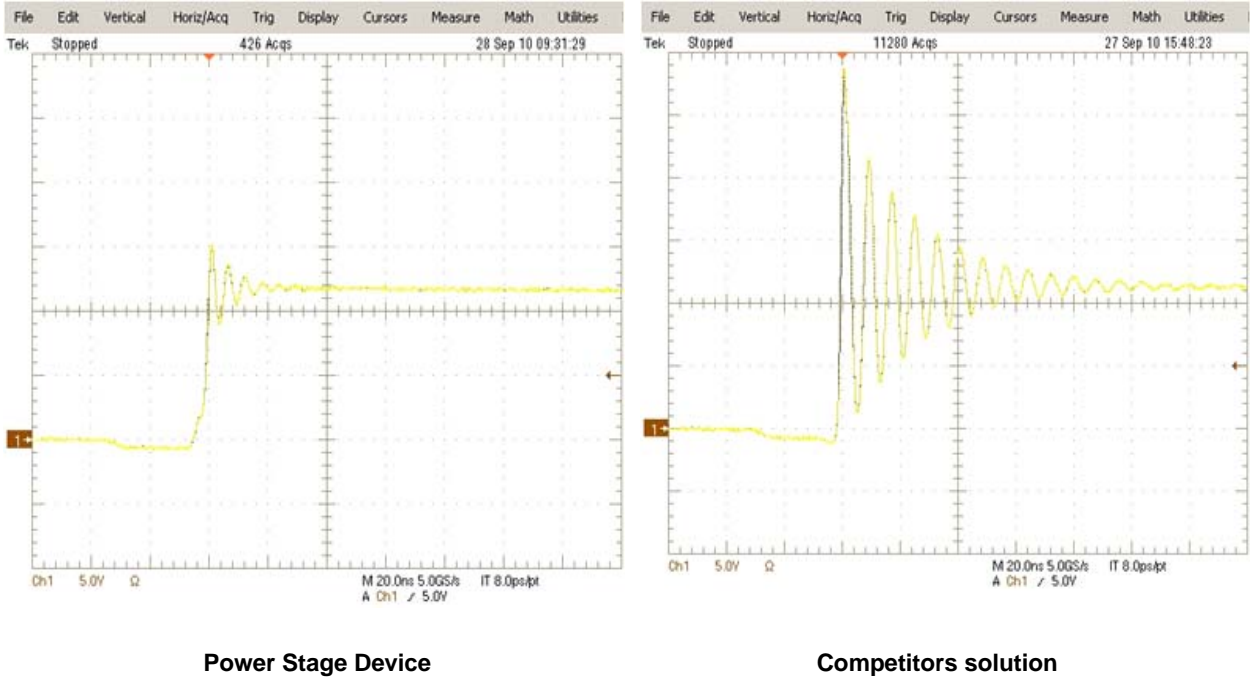

Figure 29. Power Stage phase node rising edge, High Side Turn on

*Patent Pending

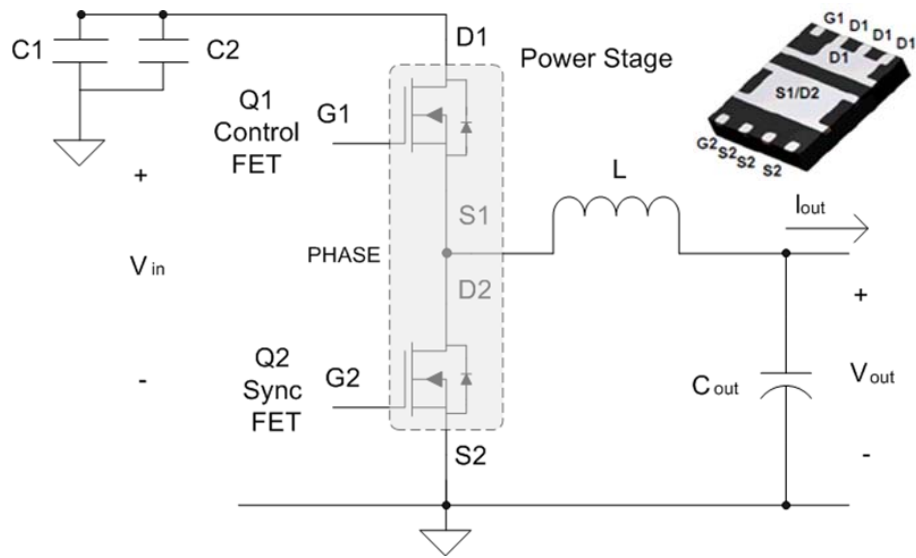

Figure 30. Shows the Power Stage in a buck converter topology

2. Recommended PCB Layout Guidelines

As a PCB designer, it is necessary to address critical issues in layout to minimize losses and optimize the performance of the power train. Power Stage is a high power density solution and all high current flow paths, such as VIN (D1), PHASE (S1/D2) and GND (S2), should be short and wide for better and stable current flow, heat radiation and system performance. A recommended layout procedure is discussed below to maximize the electrical and thermal performance of the part.

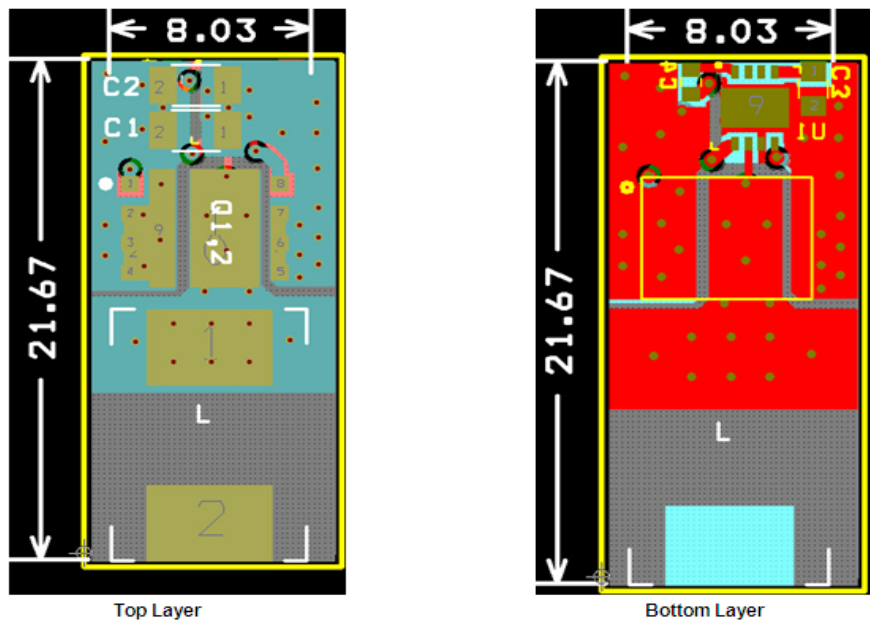
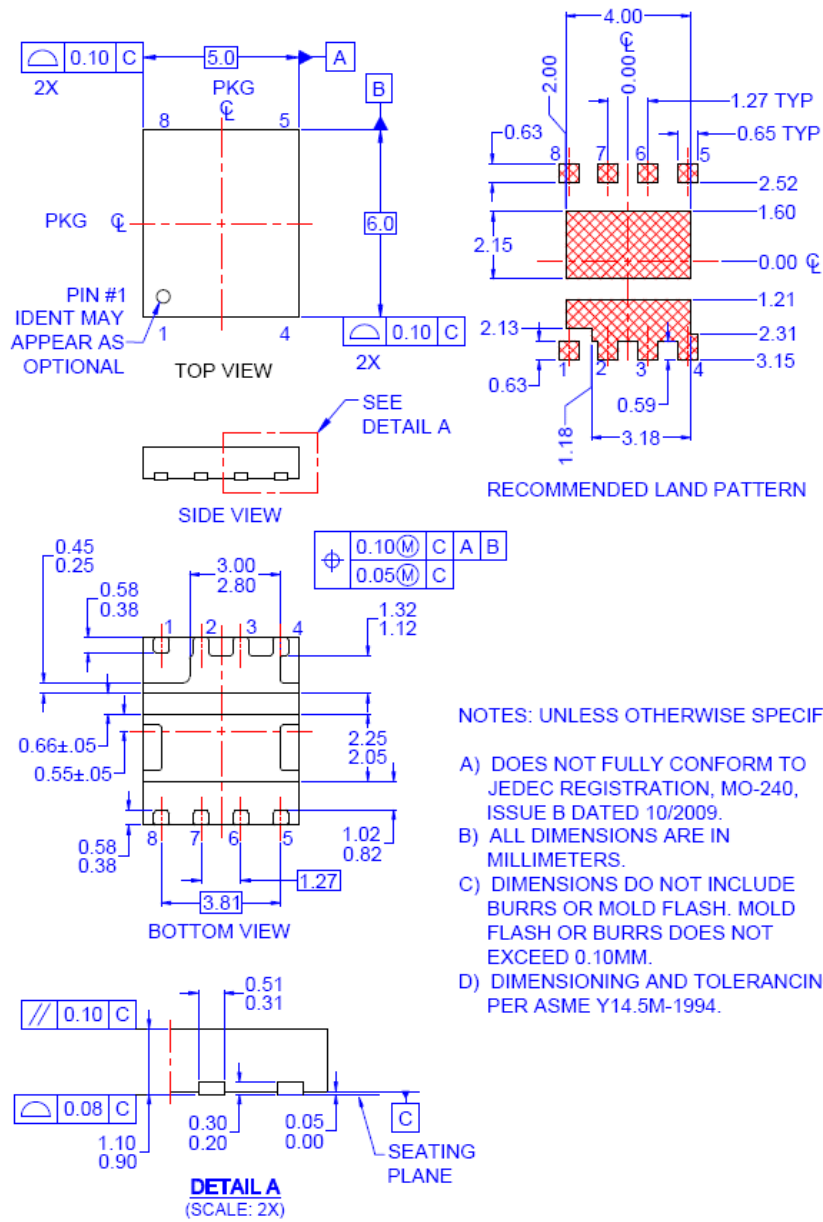

Figure 31. Recommended PCB Layout

Following is a guideline, not a requirement which the PCB designer should consider:

1. Input ceramic bypass capacitors C1 and C2 must be placed close to the D1 and S2 pins of Power Stage to help reduce parasitic inductance and high frequency conduction loss induced by switching operation. C1 and C2 show the bypass capacitors placed close to the part between D1 and S2. Input capacitors should be connected in parallel close to the part. Multiple input caps can be connected depending upon the application.
2. The PHASE copper trace serves two purposes; In addition to being the current path from the Power Stage package to the output inductor (L), it also serves as heat sink for the lower FET in the Power Stage package. The trace should be short and wide enough to present a low resistance path for the high current flow between the Power Stage and the inductor. This is done to minimize conduction losses and limit temperature rise. Please note that the PHASE node is a high voltage and high frequency switching node with high noise potential. Care should be taken to minimize coupling to adjacent traces. The reference layout in figure 31 shows a good balance between the thermal and electrical performance of Power Stage.
3. Output inductor location should be as close as possible to the Power Stage device for lower power loss due to copper trace resistance. A shorter and wider PHASE trace to the inductor reduces the conduction loss. Preferably the Power Stage should be directly in line (as shown in figure 31) with the inductor for space savings and compactness.
4. The PowerTrench® Technology MOSFETs used in the Power Stage are effective at minimizing phase node ringing. It allows the part to operate well within the breakdown voltage limits. This eliminates the need to have an external snubber circuit in most cases. If the designer chooses to use an RC snubber, it should be placed close to the part between the PHASE pad and S2 pins to dampen the high-frequency ringing.
5. The driver IC should be placed close to the Power Stage part with the shortest possible paths for the High Side gate and Low Side gates through a wide trace connection. This eliminates the effect of parasitic inductance and resistance between the driver and the MOSFET and turns the devices on and off as efficiently as possible. At higher-frequency operation this impedance can limit the gate current trying to charge the MOSFET input capacitance. This will result in slower rise and fall times and additional switching losses. Power Stage has both the gate pins on the same side of the package which allows for back mounting of the driver IC to the board. This provides a very compact path for the drive signals and improves efficiency of the part.
6. S2 pins should be connected to the GND plane with multiple vias for a low impedance grounding. Poor grounding can create a noise transient offset voltage level between S2 and driver ground. This could lead to faulty operation of the gate driver and MOSFET.
7. Use multiple vias on each copper area to interconnect top, inner and bottom layers to help smooth current flow and heat conduction. Vias should be relatively large, around 8 mils to 10 mils, and of reasonable inductance. Critical high frequency components such as ceramic bypass caps should be located close to the part and on the same side of the PCB. If not feasible, they should be connected from the backside via a network of low inductance vias.





Dimensional Outline and Pad Layout





TRADEMARKS

The following includes registered and unregistered trademarks and service marks, owned by Fairchild Semiconductor and/or its global subsidiaries, and is not intended to be an exhaustive list of all such trademarks.

- | | | | |
|---|---|---|---|
| 2Cool™ | FlashWriter®* | PDP SPM™ | The Power Franchise® |
| AccuPower™ | FPS™ | Power-SPM™ | The Right Technology for Your Success™ |
| Auto-SPM™ | F-PFS™ | PowerTrench® | the |
| AX-CAP™* | FRFET® | PowerXST™ | power |
| BitSiC® | Global Power ResourceSM | Programmable Active Droop™ | franchise |
| Build it Now™ | Green FPS™ | QFET® | TinyBoost™ |
| CorePLUS™ | Green FPS™ e-Series™ | QST™ | TinyBuck™ |
| CorePOWER™ | Gmax™ | Quiet Series™ | TinyCalc™ |
| CROSSVOLT™ | GTO™ | RapidConfigure™ | TinyLogic® |
| CTL™ | IntelliMAX™ |  | TINYOPTO™ |
| Current Transfer Logic™ | ISOPLANAR™ | Saving our world, 1mW/W/kW at a time™ | TinyPower™ |
| DEUXPEED® | MegaBuck™ | SignalWise™ | TinyPWM™ |
| Dual Cool™ | MICROCOUPLER™ | SmartMax™ | TinyWire™ |
| EcoSPARK® | MicroFET™ | SMART START™ | TranSiC® |
| EfficientMax™ | MicroPak™ | SPM® | TriFault Detect™ |
| ESBC™ | MicroPak2™ | STEALTH™ | TRUECURRENT®* |
|  | MillerDrive™ | SuperFET® | μSerDes™ |
| Fairchild® | MotionMax™ | SuperSOT™-3 |  |
| Fairchild Semiconductor® | Motion-SPM™ | SuperSOT™-6 | UHC® |
| FACT Quiet Series™ | mWSaver™ | SuperSOT™-8 | Ultra FRFET™ |
| FACT® | OptiHit™ | SupreMOS® | UniFET™ |
| FAST® | OPTOLOGIC® | SyncFET™ | VCX™ |
| FastvCore™ | OPTOPLANAR® | Sync-Lock™ | VisualMax™ |
| FETBench™ |  |  | XST™ |

*Trademarks of System General Corporation, used under license by Fairchild Semiconductor.

DISCLAIMER

FAIRCHILD SEMICONDUCTOR RESERVES THE RIGHT TO MAKE CHANGES WITHOUT FURTHER NOTICE TO ANY PRODUCTS HEREIN TO IMPROVE RELIABILITY, FUNCTION, OR DESIGN. FAIRCHILD DOES NOT ASSUME ANY LIABILITY ARISING OUT OF THE APPLICATION OR USE OF ANY PRODUCT OR CIRCUIT DESCRIBED HEREIN; NEITHER DOES IT CONVEY ANY LICENSE UNDER ITS PATENT RIGHTS, NOR THE RIGHTS OF OTHERS. THESE SPECIFICATIONS DO NOT EXPAND THE TERMS OF FAIRCHILD'S WORLDWIDE TERMS AND CONDITIONS, SPECIFICALLY THE WARRANTY THEREIN, WHICH COVERS THESE PRODUCTS.

LIFE SUPPORT POLICY

FAIRCHILD'S PRODUCTS ARE NOT AUTHORIZED FOR USE AS CRITICAL COMPONENTS IN LIFE SUPPORT DEVICES OR SYSTEMS WITHOUT THE EXPRESS WRITTEN APPROVAL OF FAIRCHILD SEMICONDUCTOR CORPORATION.

As used here in:

- Life support devices or systems are devices or systems which, (a) are intended for surgical implant into the body or (b) support or sustain life, and (c) whose failure to perform when properly used in accordance with instructions for use provided in the labeling, can be reasonably expected to result in a significant injury of the user.
- A critical component in any component of a life support, device, or system whose failure to perform can be reasonably expected to cause the failure of the life support device or system, or to affect its safety or effectiveness.

ANTI-COUNTERFEITING POLICY

Fairchild Semiconductor Corporation's Anti-Counterfeiting Policy. Fairchild's Anti-Counterfeiting Policy is also stated on our external website, www.Fairchildsemi.com, under Sales Support.

Counterfeiting of semiconductor parts is a growing problem in the industry. All manufactures of semiconductor products are experiencing counterfeiting of their parts. Customers who inadvertently purchase counterfeit parts experience many problems such as loss of brand reputation, substandard performance, failed application, and increased cost of production and manufacturing delays. Fairchild is taking strong measures to protect ourselves and our customers from the proliferation of counterfeit parts. Fairchild strongly encourages customers to purchase Fairchild parts either directly from Fairchild or from Authorized Fairchild Distributors who are listed by country on our web page cited above. Products customers buy either from Fairchild directly or from Authorized Fairchild Distributors are genuine parts, have full traceability, meet Fairchild's quality standards for handling and storage and provide access to Fairchild's full range of up-to-date technical and product information. Fairchild and our Authorized Distributors will stand behind all warranties and will appropriately address and warranty issues that may arise. Fairchild will not provide any warranty coverage or other assistance for parts bought from Unauthorized Sources. Fairchild is committed to combat this global problem and encourage our customers to do their part in stopping this practice by buying direct or from authorized distributors.

PRODUCT STATUS DEFINITIONS

Definition of Terms

Datasheet Identification	Product Status	Definition
Advance Information	Formative / In Design	Datasheet contains the design specifications for product development. Specifications may change in any manner without notice.
Preliminary	First Production	Datasheet contains preliminary data; supplementary data will be published at a later date. Fairchild Semiconductor reserves the right to make changes at any time without notice to improve design.
No Identification Needed	Full Production	Datasheet contains final specifications. Fairchild Semiconductor reserves the right to make changes at any time without notice to improve the design.
Obsolete	Not In Production	Datasheet contains specifications on a product that is discontinued by Fairchild Semiconductor. The datasheet is for reference information only.

AMEYA360

Components Supply Platform

Authorized Distribution Brand :



Website :

Welcome to visit www.ameya360.com

Contact Us :

➤ Address :

401 Building No.5, JiuGe Business Center, Lane 2301, Yishan Rd
Minhang District, Shanghai , China

➤ Sales :

Direct +86 (21) 6401-6692

Email amall@ameya360.com

QQ 800077892

Skype [ameyasales1](#) [ameyasales2](#)

➤ Customer Service :

Email service@ameya360.com

➤ Partnership :

Tel +86 (21) 64016692-8333

Email mkt@ameya360.com