

High and Low Side Driver

Features

- Floating channel designed for bootstrap operation
- Fully operational to 200V
- Tolerant to negative transient voltage, dV/dt immune
- Gate drive supply range from 10 to 20V
- Independent low and high side channels
- Input logic HIN/LIN active high
- Undervoltage lockout for both channels
- 3.3V and 5V logic compatible
- CMOS Schmitt-triggered inputs with pull-down
- Matched propagation delay for both channels

Description

The IR2011 is a high power, high speed power MOSFET driver with independent high and low side referenced output channels. Logic inputs are compatible with standard CMOS or LSTTL output, down to 3.0V logic. The output drivers feature a high pulse current buffer stage designed for minimum driver cross-conduction. Propagation delays are matched to simplify use in high frequency applications. The floating channel can be used to drive an N-channel power MOSFET in the high side configuration which operates up to 200 volts. Proprietary HVIC and latch immune CMOS technologies enable ruggedized monolithic construction.

Applications

- Converters
- DC motor drive

Product Summary

| | |
|---------------------------|-------------|
| V_{OFFSET} (max) | 200V |
| $I_{\text{O+/-}}$ (typ) | 1.0A / 1.0A |
| V_{OUT} | 10 – 20V |
| $t_{\text{on/off}}$ (typ) | 80ns & 60ns |
| Delay Matching (max) | 20ns |

Package Options

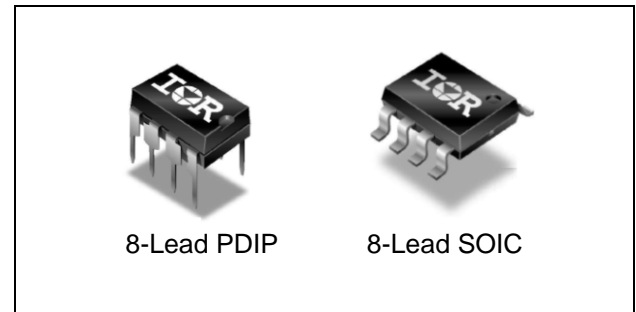

Ordering Information

| Base Part Number | Package Type | Standard Pack | | Orderable Part Number |
|------------------|--------------|---------------|----------|-----------------------|
| | | Form | Quantity | |
| IR2011PBF | PDIP8 | Tube | 50 | IR2011PBF |
| IR2011SPBF | SO8N | Tube | 95 | IR2011SPBF |
| IR2011SPBF | SO8N | Tape and Reel | 2500 | IR2011STRPBF |

Typical Connection Diagram

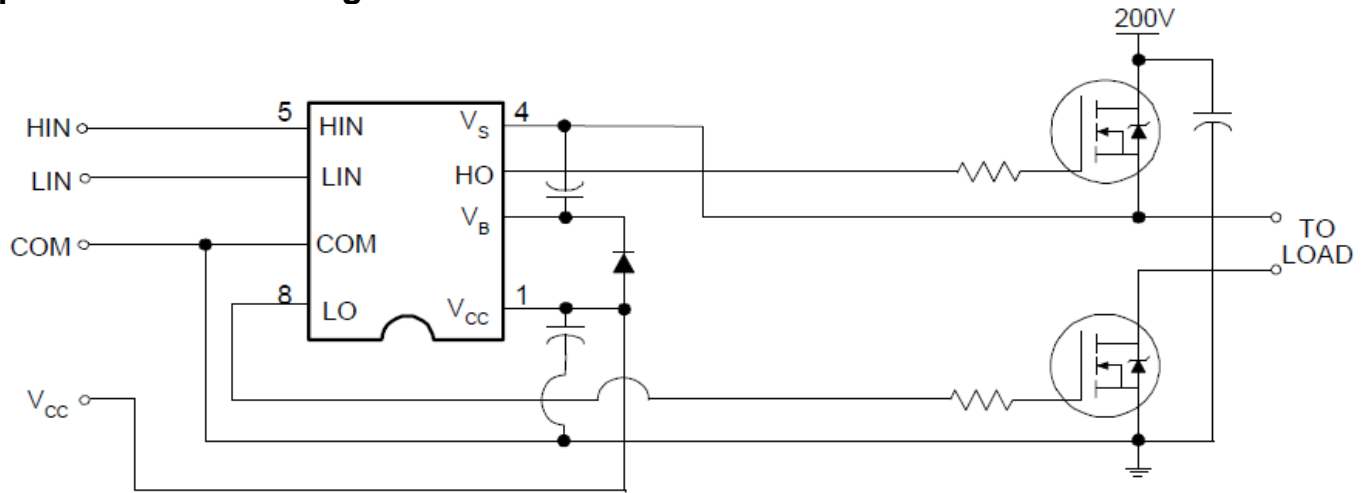

(Refer to Lead Assignments for correct configuration.) This diagram shows electrical connections only. Please refer to our Application Notes and Design Tips for proper circuit board layout

Absolute Maximum Ratings

Absolute maximum ratings indicate sustained limits beyond which damage to the device may occur. All voltage parameters are absolute voltages referenced to COM. The thermal resistance and power dissipation ratings are measured under board mounted and still air conditions.

| Symbol | Definition | Min. | Max. | Units | |
|------------|---|-------------|----------------|------------------|--------------------|
| V_B | High side floating supply voltage | -0.3 | 225 | V | |
| V_S | High side floating supply offset voltage | $V_B - 25$ | $V_B + 0.3$ | | |
| V_{HO} | High side floating output voltage | $V_S - 0.3$ | $V_B + 0.3$ | | |
| V_{CC} | Low side fixed supply voltage | -0.3 | 25 | | |
| V_{LO} | Low side output voltage | -0.3 | $V_{CC} + 0.3$ | | |
| V_{IN} | Logic input voltage (HIN, LIN) | -0.3 | $V_{CC} + 0.3$ | | |
| dV_S/dt | Allowable offset supply voltage transient | — | 50 | V/ns | |
| P_D | Package power dissipation @ $T_A \leq +25^\circ\text{C}$ | 8-Lead PDIP | — | 1.0 | W |
| | | 8-Lead SOIC | — | 0.625 | |
| R_{thJA} | Thermal resistance, junction to ambient | 8-Lead PDIP | — | 125 | $^\circ\text{C/W}$ |
| | | 8-Lead SOIC | — | 200 | |
| T_J | Junction temperature | — | 150 | $^\circ\text{C}$ | |
| T_S | Storage temperature | -55 | 150 | | |
| T_L | Lead temperature (soldering, 10 seconds) | — | 300 | | |

Recommended Operating Conditions

For proper operation the device should be used within the recommended conditions. The V_S and COM offset ratings are tested with all supplies biased at 15V differential.

| Symbol | Definition | Min. | Max. | Units |
|----------|--|------------|------------|------------------|
| V_B | High side floating supply absolute voltage | $V_S + 10$ | $V_S + 20$ | V |
| V_S | High side floating supply offset voltage | † | 200 | |
| V_{HO} | High side floating output voltage | V_S | V_B | |
| V_{CC} | Low side fixed supply voltage | 10 | 20 | |
| V_{LO} | Low side output voltage | 0 | V_{CC} | |
| V_{IN} | Logic input voltage (HIN, LIN) | COM | 5.5 | |
| T_A | Ambient temperature | -40 | 125 | $^\circ\text{C}$ |

† Logic operational for V_S of -4 to +200V. Logic state held for V_S of -4V to $-V_{BS}$.

Dynamic Electrical Characteristics

V_{BIAS} (V_{CC} , V_{BS}) = 15V, C_L = 1000pF and T_A = 25°C unless otherwise specified. Figure 1 shows the timing definitions.

| Symbol | Definition | Min. | Typ. | Max. | Units | Test Conditions |
|-----------|--|------|------|------|-------|-----------------|
| t_{on} | Turn-on propagation delay | — | 80 | — | ns | $V_S = 0V$ |
| t_{off} | Turn-off propagation delay | — | 75 | — | | $V_S = 200V$ |
| t_r | Turn-on rise time | — | 35 | 50 | | |
| t_f | Turn-off fall time | — | 20 | 35 | | |
| DM1 | Turn-on delay matching $ t_{on}(H) - t_{on}(L) $ | — | — | 20 | | |
| DM2 | Turn-off delay matching $ t_{off}(H) - t_{off}(L) $ | — | — | 20 | | |

Static Electrical Characteristics

V_{BIAS} (V_{CC} , V_{BS}) = 15V and T_A = 25°C unless otherwise specified. The V_{IN} , V_{TH} and I_{IN} parameters are referenced to COM and are applicable to all logic input leads: HIN and LIN. The V_O and I_O parameters are referenced to COM and are applicable to the respective output leads: HO or LO.

| Symbol | Definition | Min. | Typ. | Max. | Units | Test Conditions |
|-------------|---|------|------|------|---------|------------------------------------|
| V_{IH} | Logic "1" input voltage | 2.2 | — | — | V | $V_{CC} = 10V - 20V$ |
| V_{IL} | Logic "0" input voltage | — | — | 0.7 | | |
| V_{OH} | High level output voltage, $V_{BIAS} - V_O$ | — | — | 2.0 | | $I_O = 0A$ |
| V_{OL} | Low level output voltage, V_O | — | — | 0.2 | | $I_O = 20mA$ |
| I_{LK} | Offset supply leakage current | — | — | 50 | μA | $V_B = V_S = 200V$ |
| I_{QBS} | Quiescent V_{BS} supply current | — | 90 | 210 | | $V_{IN} = 0V$ or 3.3V |
| I_{QCC} | Quiescent V_{CC} supply current | — | 140 | 230 | | |
| I_{IN+} | Logic "1" input bias current | — | 7.0 | 20 | | $V_{IN} = 3.3V$ |
| I_{IN-} | Logic "0" input bias current | — | — | 1.0 | | $V_{IN} = 0V$ |
| V_{BSUV+} | V_{BS} supply undervoltage positive going threshold | 8.2 | 9.0 | 9.8 | V | |
| V_{BSUV-} | V_{BS} supply undervoltage negative going threshold | 7.4 | 8.2 | 9.0 | | |
| V_{CCUV+} | V_{CC} supply undervoltage positive going threshold | 8.2 | 9.0 | 9.8 | | |
| V_{CCUV-} | V_{CC} supply undervoltage negative going threshold | 7.4 | 8.2 | 9.0 | | |
| I_{O+} | Output high short circuit pulsed current | — | 1.0 | — | A | $V_O = 0V$, $PW \leq 10 \mu s$ |
| I_{O-} | Output low short circuit pulsed current | — | 1.0 | — | | $V_O = 15V$ $PW \leq 10 \mu s$ |

Functional Block Diagram

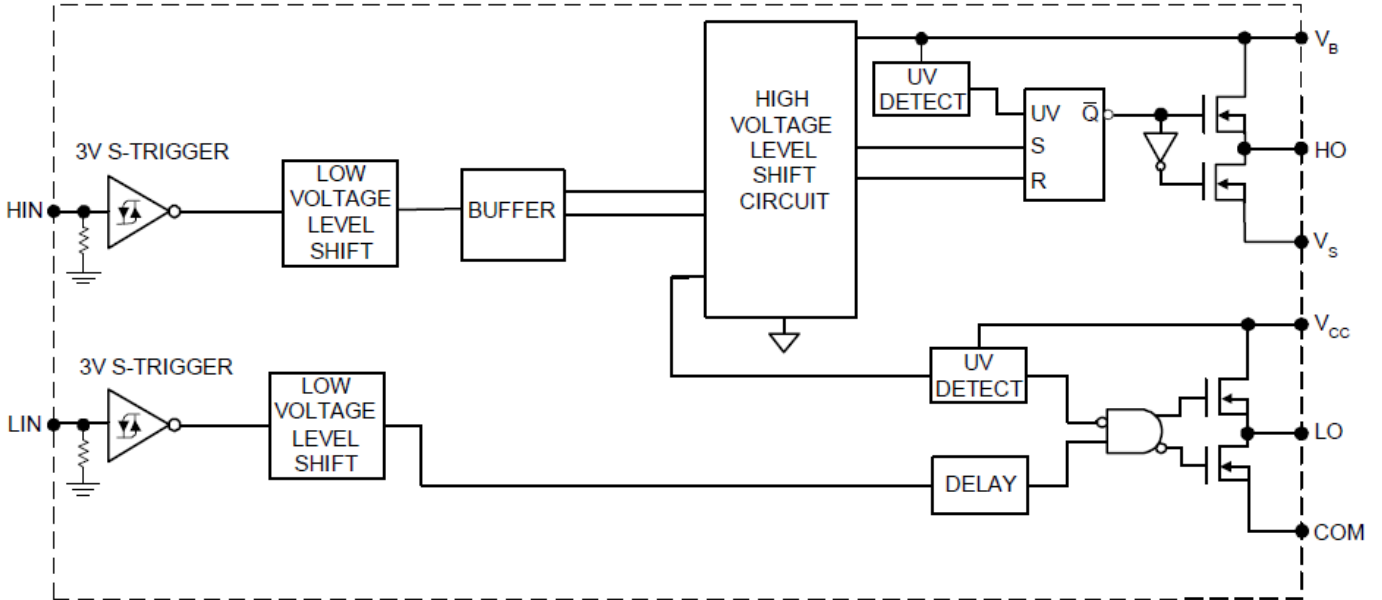

Lead Definitions

| Symbol | Description |
|-----------------|--|
| HIN | Logic input for high side gate driver outputs (HO), in phase |
| LIN | Logic input for low side gate driver outputs (LO), in phase |
| V _B | High side floating supply |
| HO | High side gate drive output |
| V _S | High side floating supply return |
| V _{CC} | Low side supply |
| LO | Low side gate drive output |
| COM | Low side return |

Lead Assignments

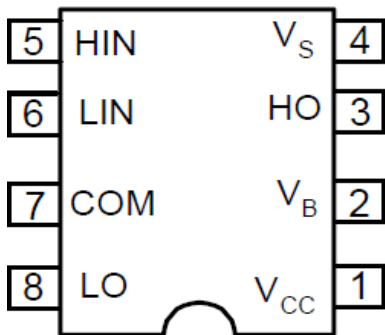

8-Lead PDIP

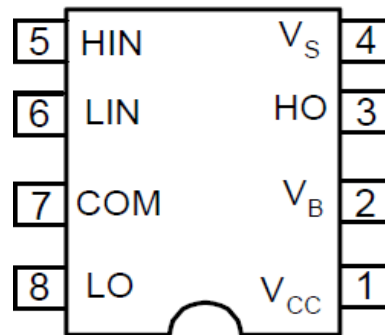

8-Lead SOIC

Application Information and Additional Details

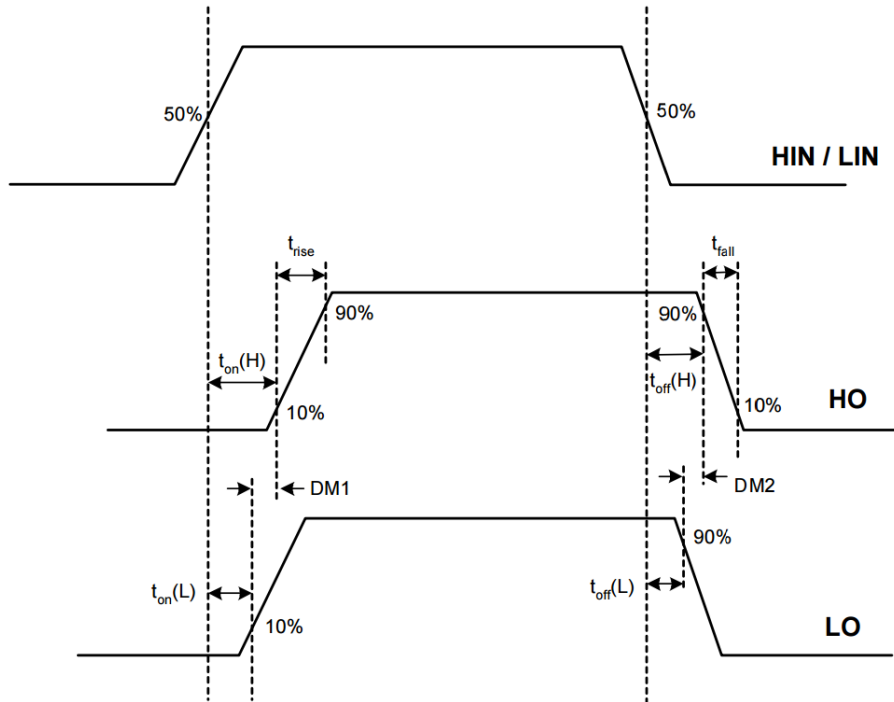

Figure 1. Timing Diagram

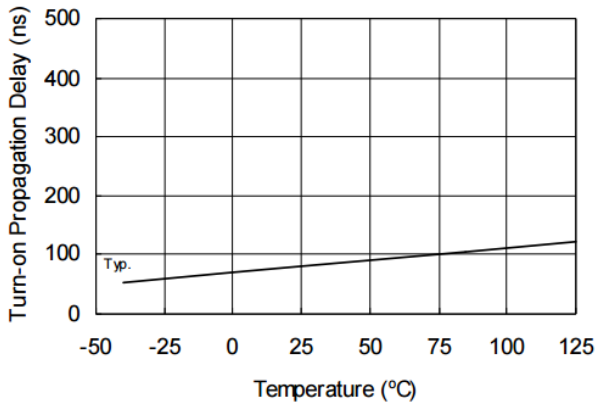

Figure 2A. Turn-on Propagation Delay vs. Temperature

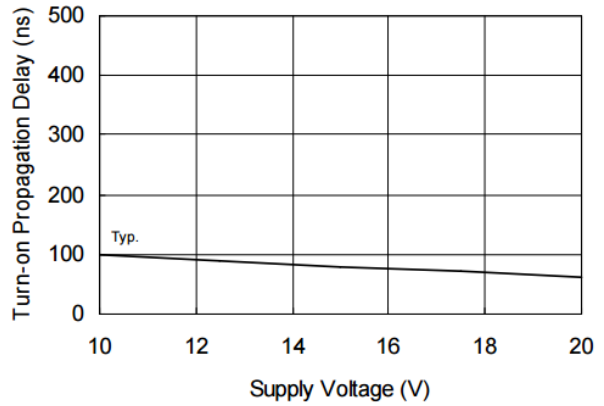

Figure 2B. Turn-on Propagation Delay vs. Supply Voltage

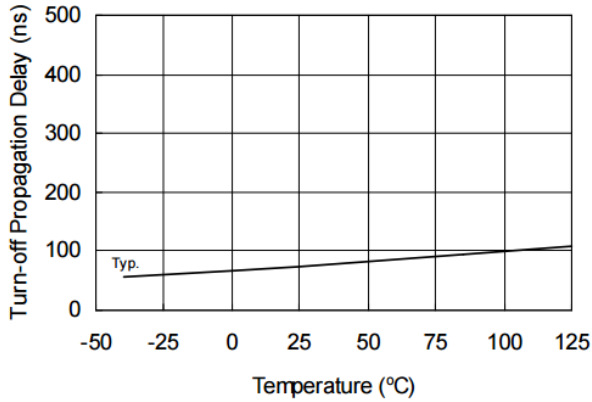

Figure 3A. Turn-off Propagation Delay vs. Temperature

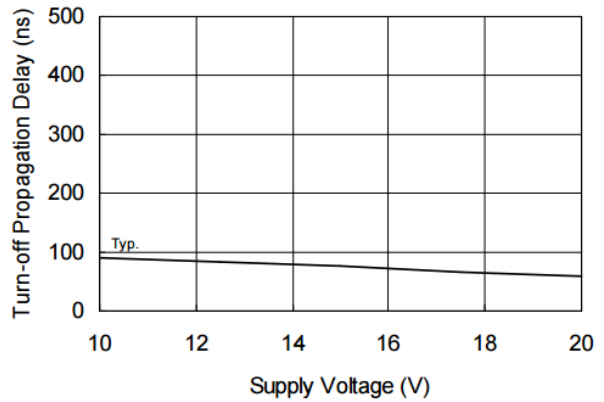

Figure 3B. Turn-off Propagation Delay vs. Supply Voltage

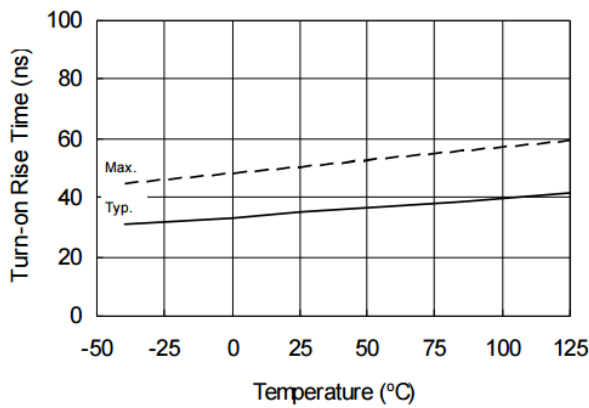

Figure 4A. Turn-on Rise Time vs. Temperature

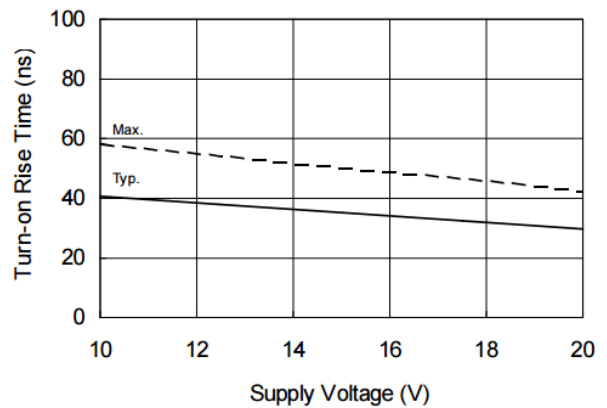

Figure 4B. Turn-on Rise Time vs. Supply Voltage

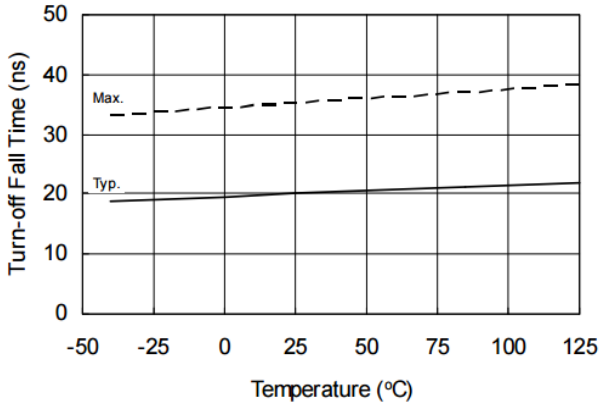

Figure 5A. Turn-off Fall Time vs. Temperature

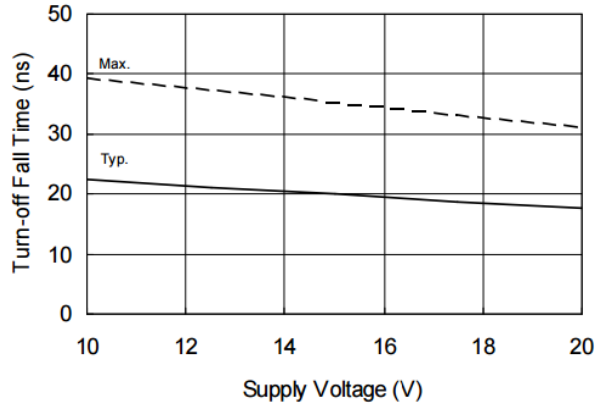

Figure 5B. Turn-off Fall Time vs. Supply Voltage

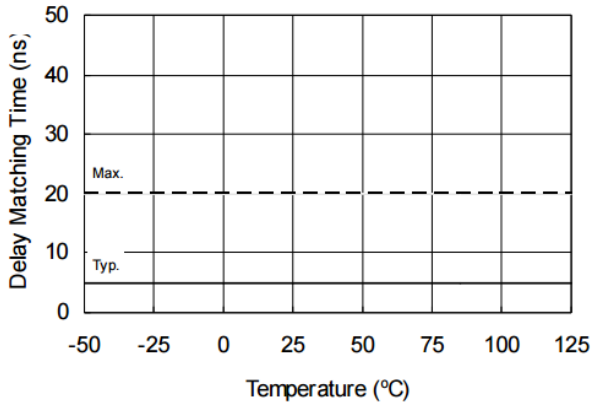

Figure 6A. Turn-on Delay Matching vs. Temperature

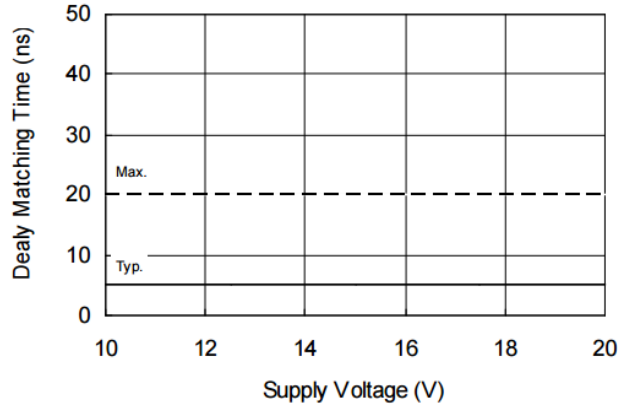

Figure 6B. Turn-on Delay Matching Time vs. Supply Voltage

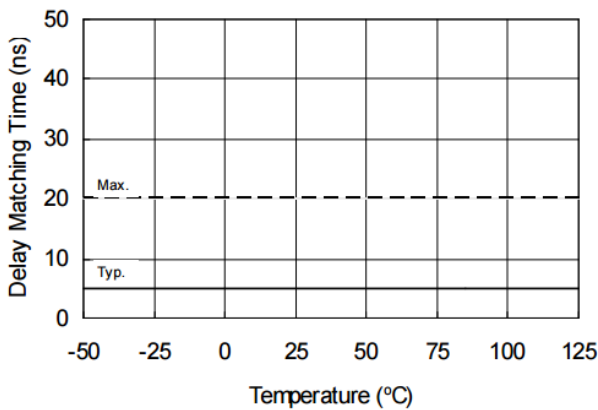

Figure 7A. Turn-off Delay Matching Time vs. Temperature

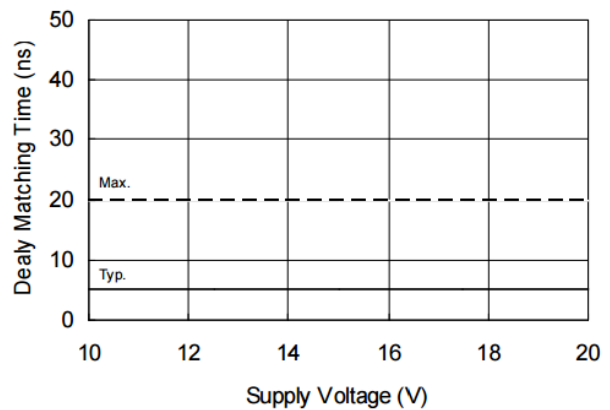

Figure 7B. Turn-off Delay Matching Time vs. Supply Voltage

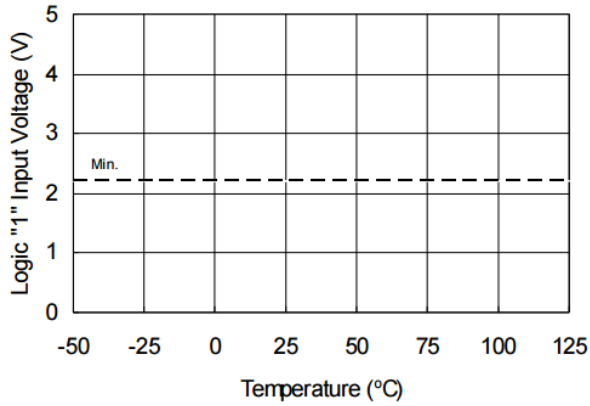

Figure 8A. Logic "1" Input Voltage vs. Temperature

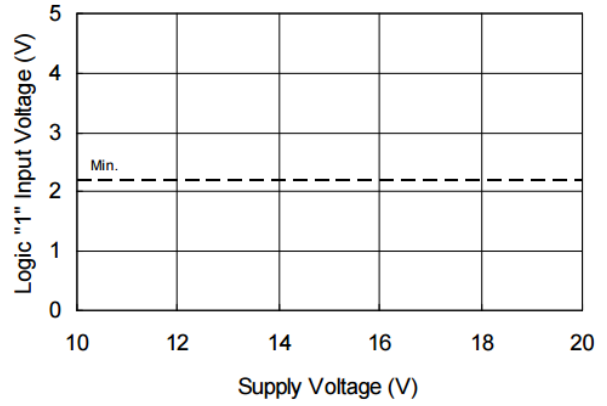

Figure 8B. Logic "1" Input Voltage vs. Supply Voltage

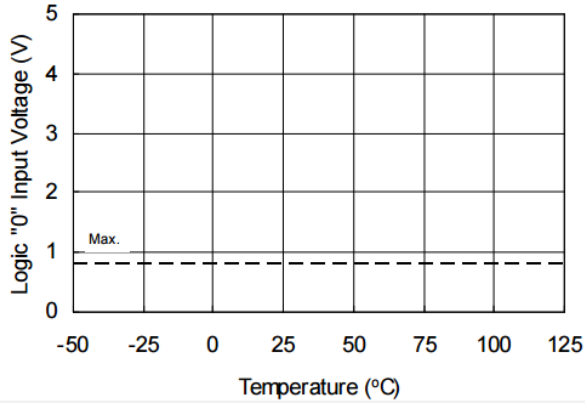

Figure 9A. Logic "0" Input Voltage vs. Temperature

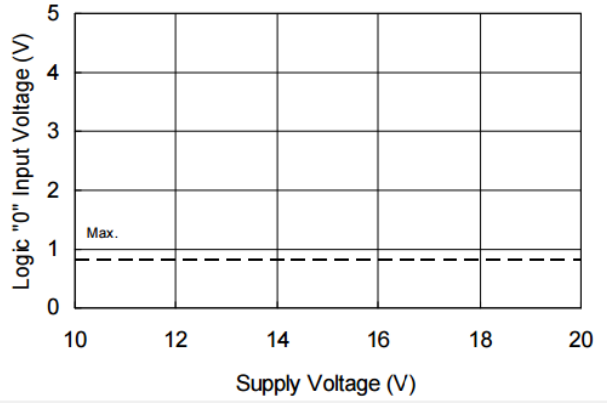

Figure 9B. Logic "0" Input Voltage vs. Supply Voltage

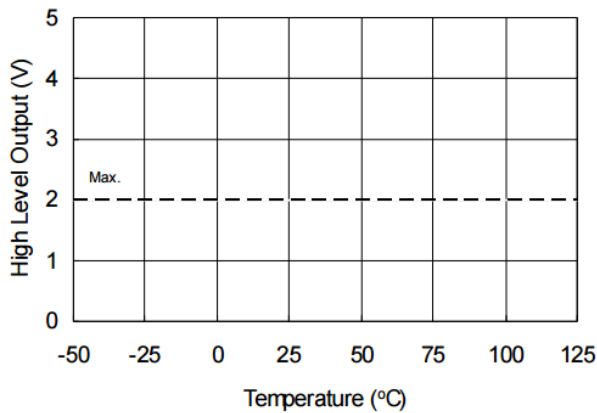

Figure 10A. High Level Output vs. Temperature

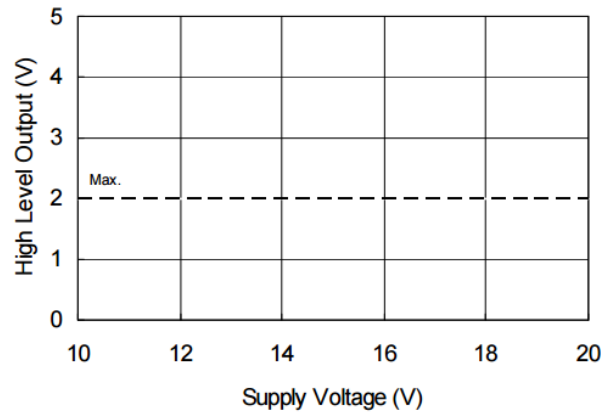

Figure 10B. High Level Output vs. Supply Voltage

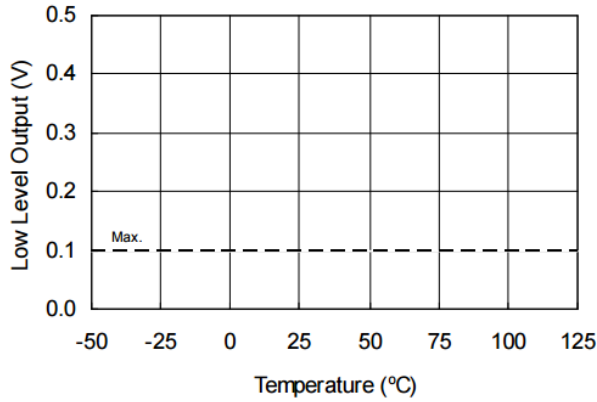

Figure 11A. Low Level Output vs. Temperature

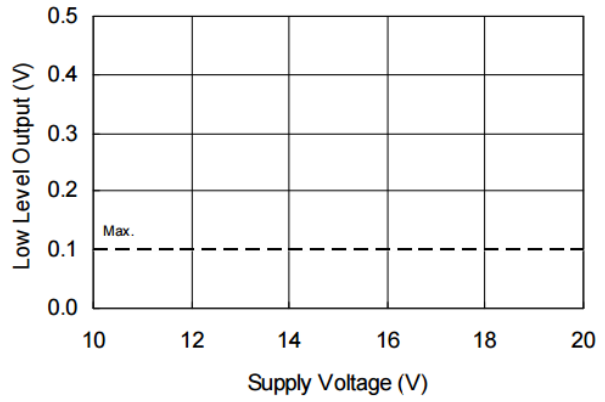

Figure 11B. Low Level Output vs. Supply Voltage

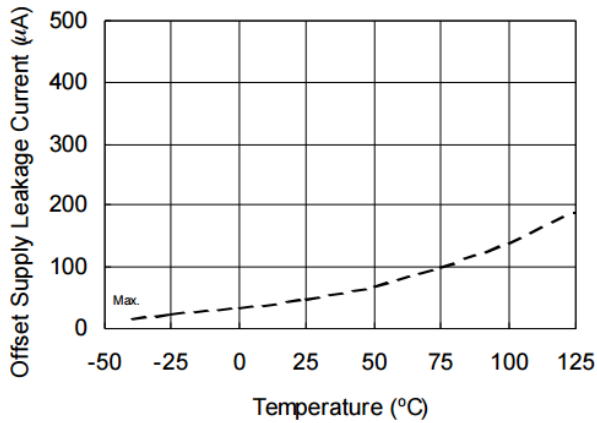

Figure 12A. Offset Supply Leakage Current vs. Temperature

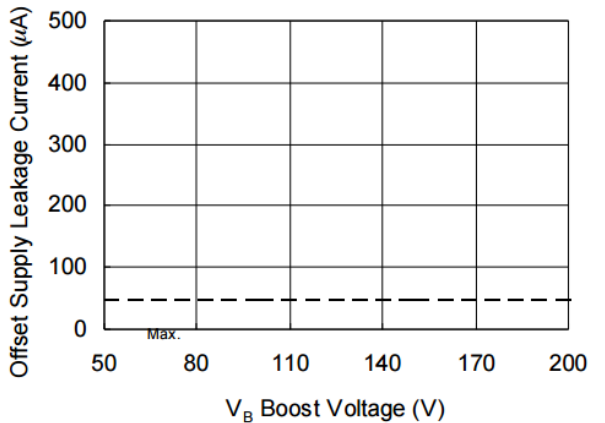

Figure 12B. Offset Supply Leakage Current vs. Supply Voltage

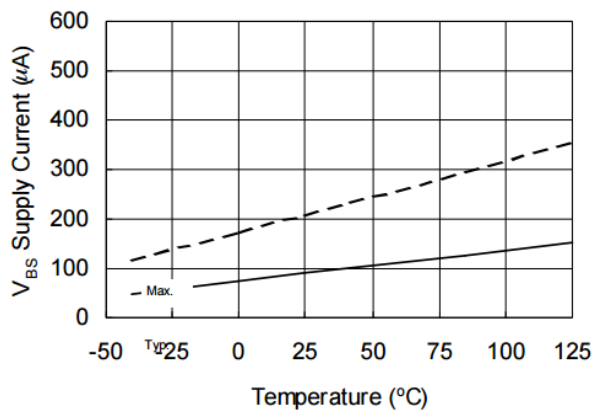

Figure 13A. V_{BS} Supply Current vs. Temperature

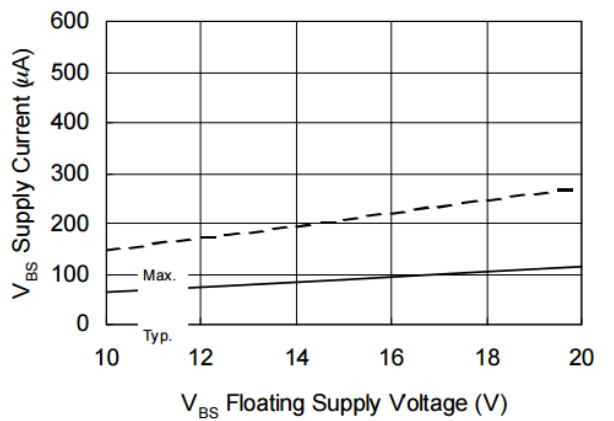

Figure 13B. V_{BS} Supply Current vs. Supply Voltage

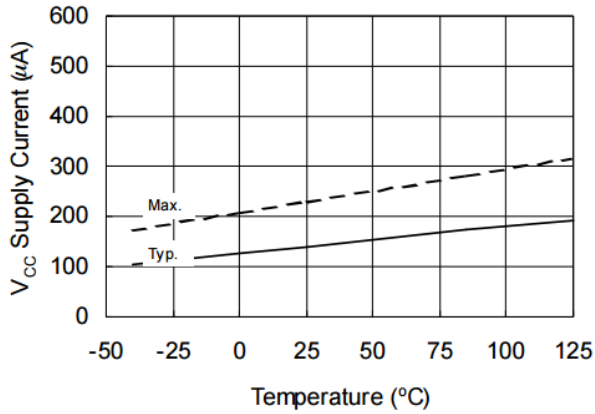

Figure 14A. V_{CC} Supply Current vs. Temperature

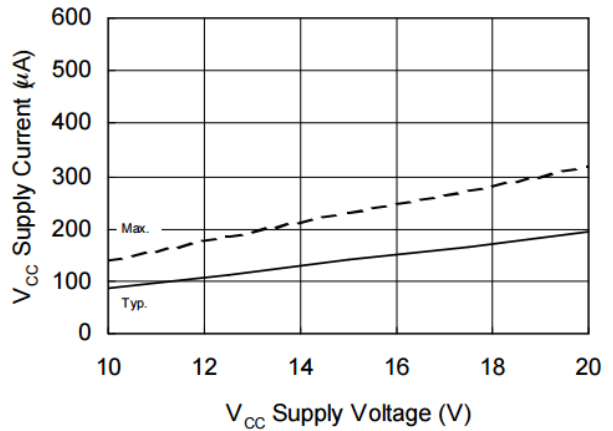

Figure 14B. V_{CC} Supply Current vs. V_{CC} Supply Voltage

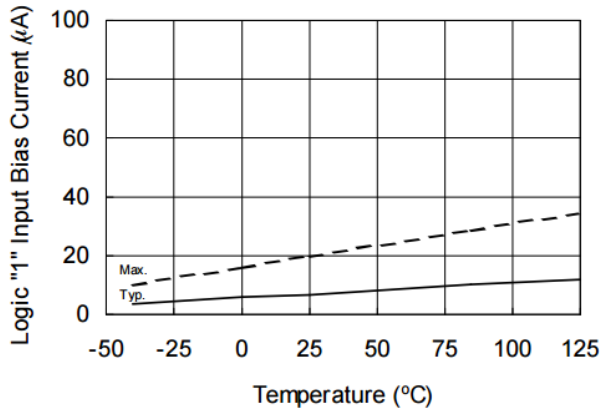

Figure 15A. Logic "1" Input Bias Current vs. Temperature

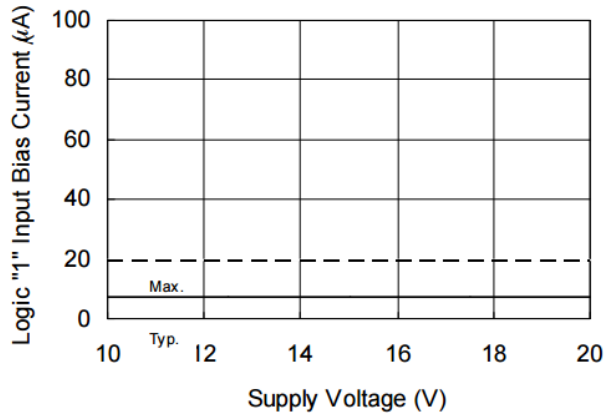

Figure 15 B. Logic "1" Input Bias Current vs. Supply Voltage

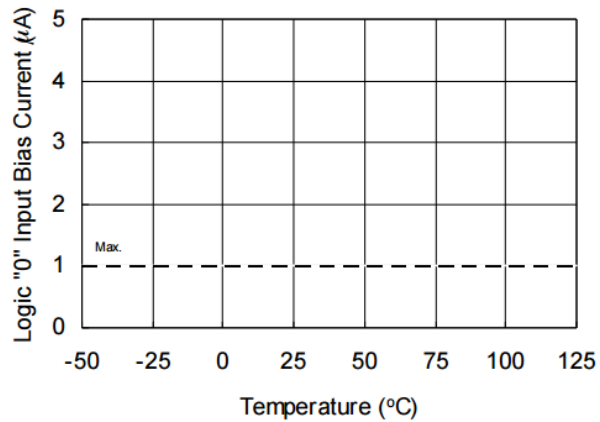

Figure 16A. Logic "0" Input Bias Current vs. Temperature

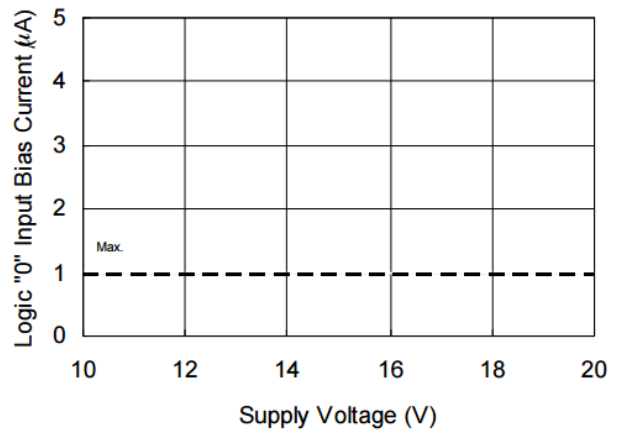

Figure 16B. Logic "0" Input Bias Current vs. Supply Voltage

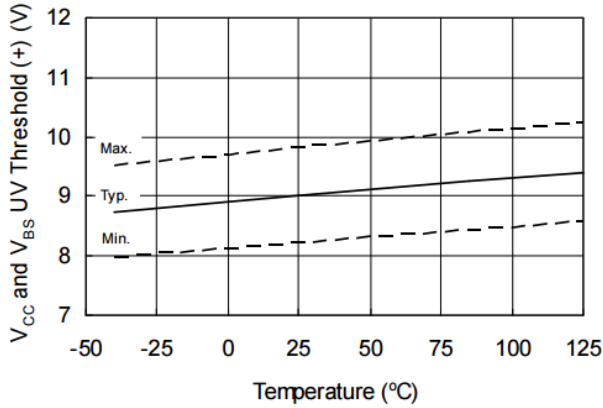

Figure 17. V_{CC} and V_{BS} Undervoltage Threshold (+) vs. Temperature

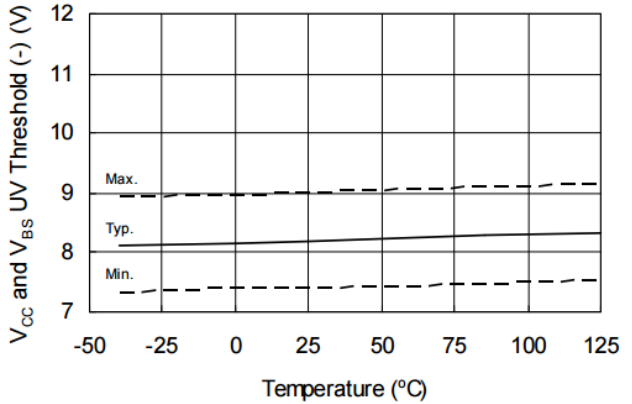

Figure 18. V_{CC} and V_{BS} Undervoltage Threshold (-) vs. Temperature

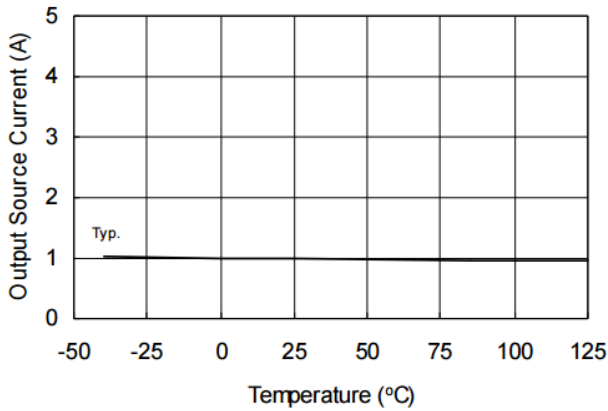

Figure 19A. Output Source Current vs. Temperature

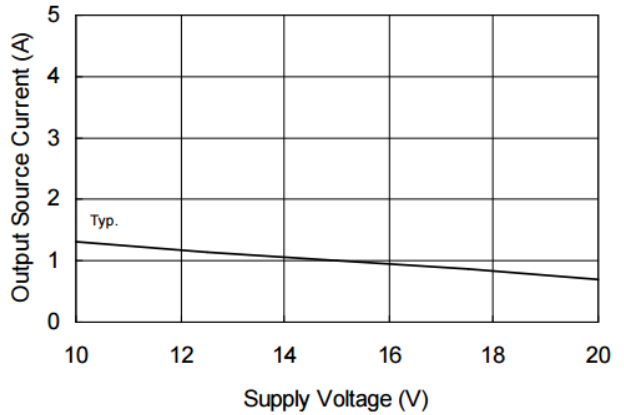

Figure 19B. Output Source Current vs. Supply Voltage

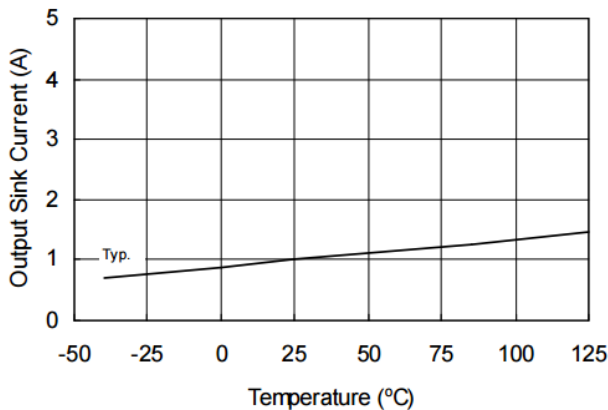

Figure 20A. Output Sink Current vs. Temperature

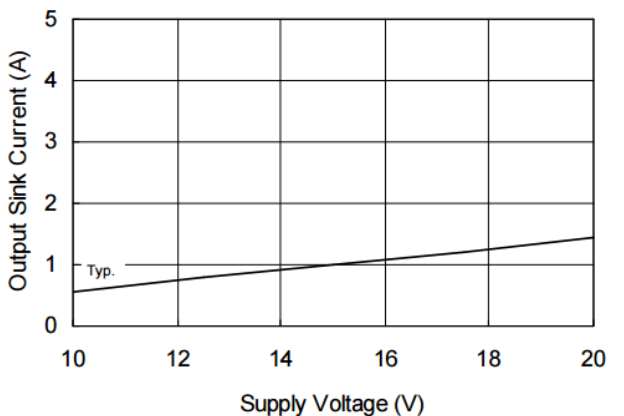

Figure 20B. Output Sink Current vs. Supply Voltage

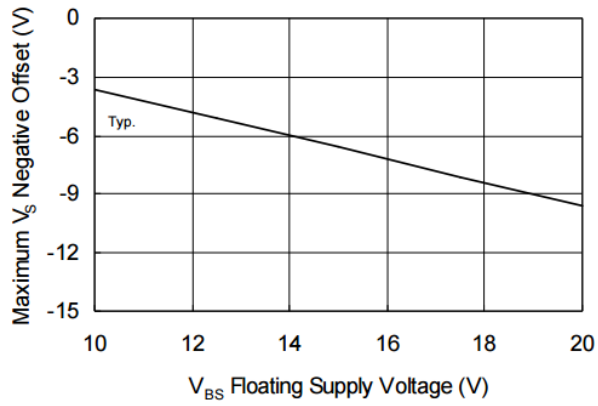
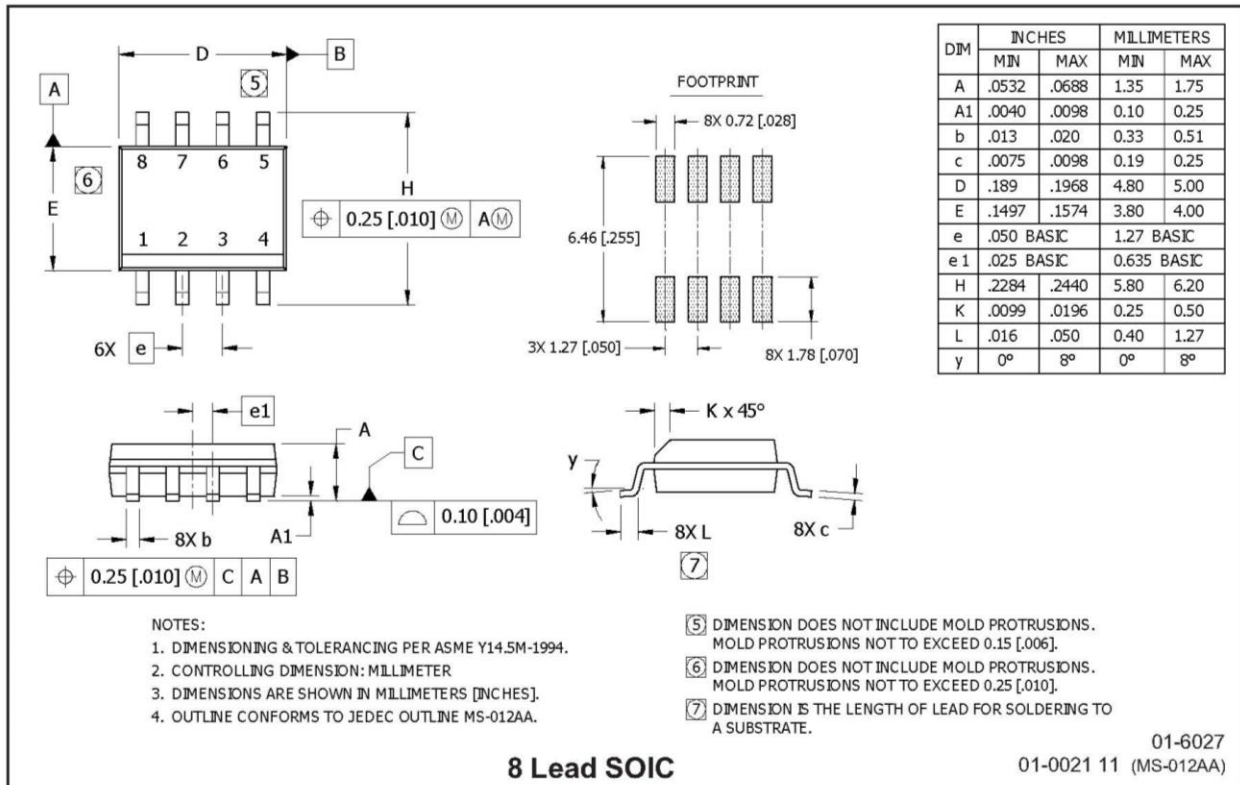
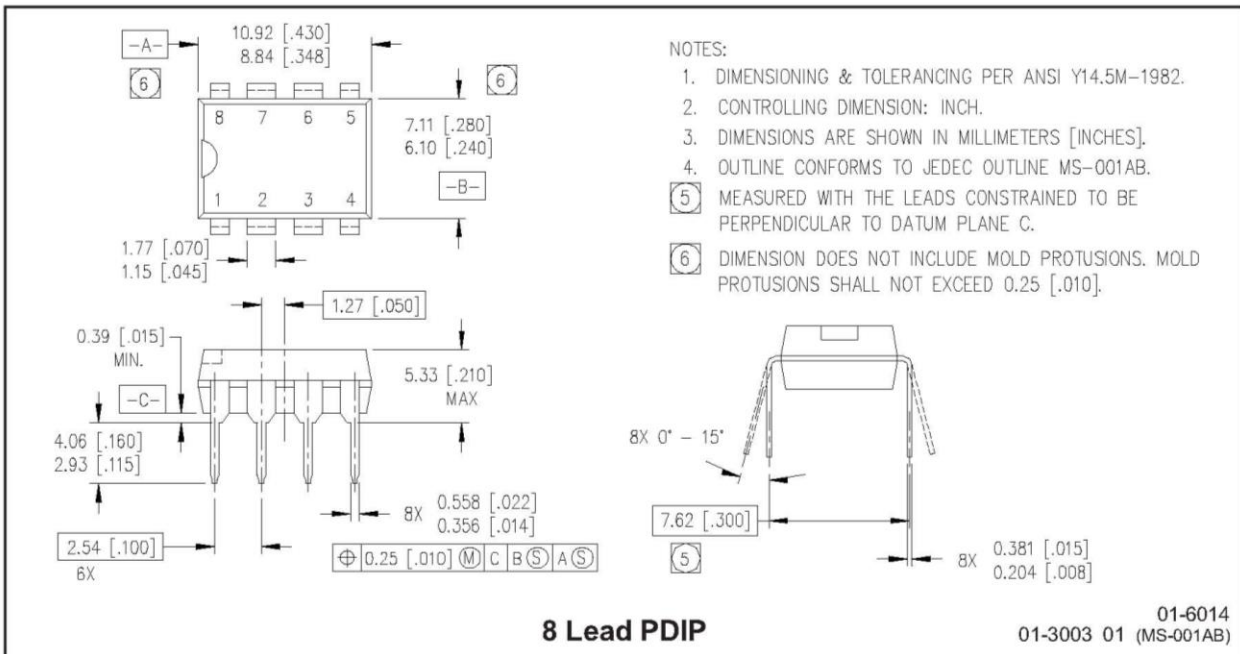
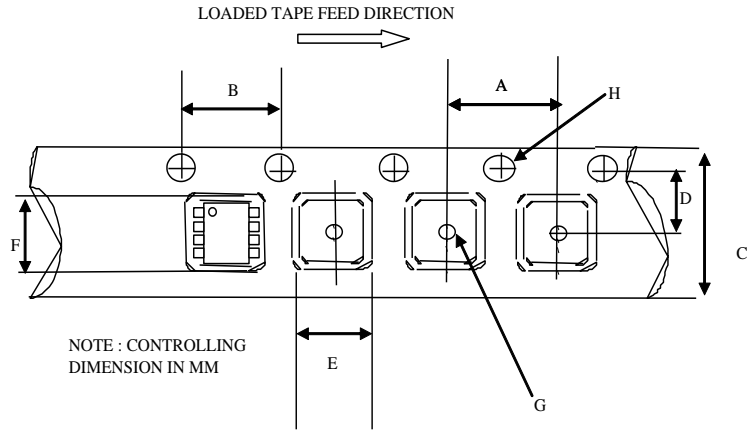

Figure 21. Maximum V_S Negative Offset vs. V_{BS} Floating Supply Voltage

Package Details

Tape and Reel Details



CARRIER TAPE DIMENSION FOR 8SOICN

| Code | Metric | | Imperial | |
|------|--------|-------|----------|-------|
| | Min | Max | Min | Max |
| A | 7.90 | 8.10 | 0.311 | 0.318 |
| B | 3.90 | 4.10 | 0.153 | 0.161 |
| C | 11.70 | 12.30 | 0.46 | 0.484 |
| D | 5.45 | 5.55 | 0.214 | 0.218 |
| E | 6.30 | 6.50 | 0.248 | 0.255 |
| F | 5.10 | 5.30 | 0.200 | 0.208 |
| G | 1.50 | n/a | 0.059 | n/a |
| H | 1.50 | 1.60 | 0.059 | 0.062 |

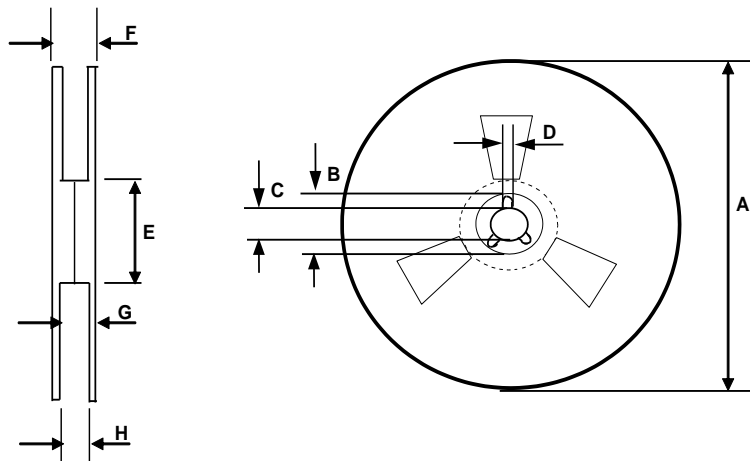

REEL DIMENSIONS FOR 8SOICN

| Code | Metric | | Imperial | |
|------|--------|--------|----------|--------|
| | Min | Max | Min | Max |
| A | 329.60 | 330.25 | 12.976 | 13.001 |
| B | 20.95 | 21.45 | 0.824 | 0.844 |
| C | 12.80 | 13.20 | 0.503 | 0.519 |
| D | 1.95 | 2.45 | 0.767 | 0.096 |
| E | 98.00 | 102.00 | 3.858 | 4.015 |
| F | n/a | 18.40 | n/a | 0.724 |
| G | 14.50 | 17.10 | 0.570 | 0.673 |
| H | 12.40 | 14.40 | 0.488 | 0.566 |

Part Marking Information

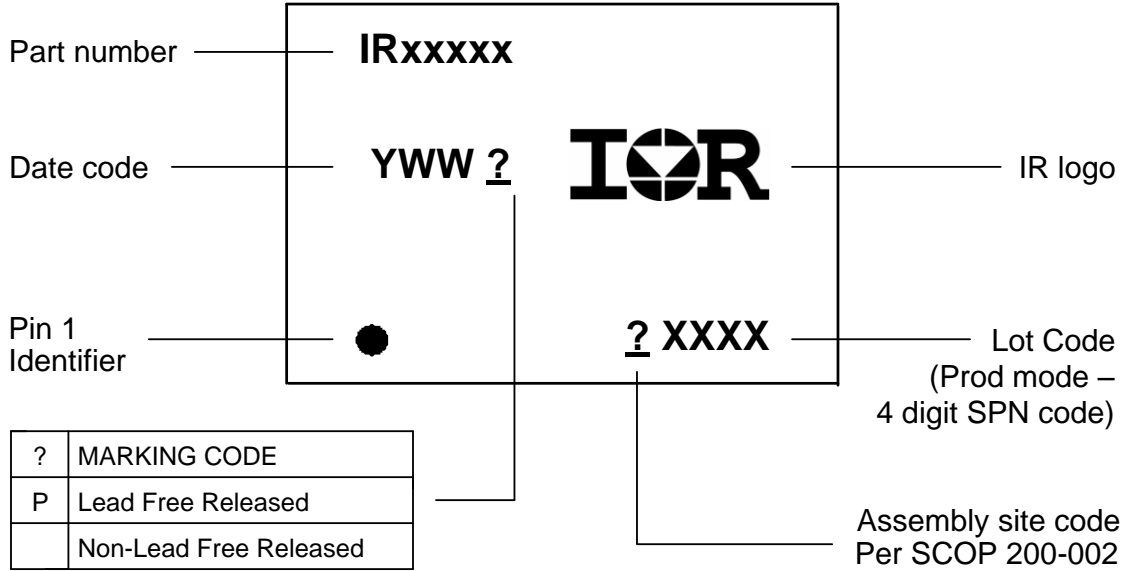

Qualification Information[†]

| | | |
|-----------------------------------|-------------|---|
| Qualification Level | | Industrial ^{††} (per JEDEC JESD 47) |
| | | Comments: This family of ICs has passed JEDEC's Industrial qualification. IR's Consumer qualification level is granted by extension of the higher Industrial level. |
| Moisture Sensitivity Level | 8-Lead SOIC | MSL2 ^{†††} (per IPC/JEDEC J-STD-020) |
| RoHS Compliant | | Yes |

- † Qualification standards can be found at International Rectifier's web site <http://www.irf.com/>
- †† Higher qualification ratings may be available should the user have such requirements. Please contact your International Rectifier sales representative for further information.
- ††† Higher MSL ratings may be available for the specific package types listed here. Please contact your International Rectifier sales representative for further information.

The information provided in this document is believed to be accurate and reliable. However, International Rectifier assumes no responsibility for the consequences of the use of this information. International Rectifier assumes no responsibility for any infringement of patents or of other rights of third parties which may result from the use of this information. No license is granted by implication or otherwise under any patent or patent rights of International Rectifier. The specifications mentioned in this document are subject to change without notice. This document supersedes and replaces all information previously supplied.

For technical support, please contact IR's Technical Assistance Center
<http://www.irf.com/technical-info/>

WORLD HEADQUARTERS:
 233 Kansas St., El Segundo, California 90245
 Tel: (310) 252-7105

AMEYA360

Components Supply Platform

Authorized Distribution Brand :



Website :

Welcome to visit www.ameya360.com

Contact Us :

➤ Address :

401 Building No.5, JiuGe Business Center, Lane 2301, Yishan Rd
Minhang District, Shanghai , China

➤ Sales :

Direct +86 (21) 6401-6692

Email amall@ameya360.com

QQ 800077892

Skype [ameyasales1](#) [ameyasales2](#)

➤ Customer Service :

Email service@ameya360.com

➤ Partnership :

Tel +86 (21) 64016692-8333

Email mkt@ameya360.com