

### Features

- Glass Passivated Die Construction
- Super-Fast Recovery Time For High Efficiency
- Low Forward Voltage Drop and High Current Capability
- Surge Overload Rating to 35A Peak
- Ideally Suited for Automated Assembly
- **Lead Free Finish, RoHS Compliant (Note 5)**

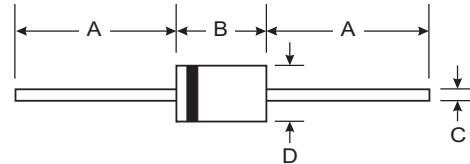

### Mechanical Data

- Case: DO-41
- Case Material: Molded Plastic. UL Flammability Classification Rating 94V-0
- Moisture Sensitivity: Level 1 per J-STD-020C
- Terminals: Finish — Bright Tin. Solderable per MIL-STD-202, Method 208
- Marking: MUR140: R140  
MUR160: R160
- Polarity: Cathode Band
- Mounting Position: Any
- Weight: 0.35 grams (approximate)

DO-41 Plastic		
Dim	Min	Max
A	25.40	—
B	4.06	5.21
C	0.71	0.864
D	2.00	2.72
All Dimensions in mm		

### Maximum Ratings and Electrical Characteristics

@ T<sub>A</sub> = 25°C unless otherwise specified

Single phase, half wave, 60Hz, resistive or inductive load.  
For capacitive load, derate current by 20%.

Characteristic	Symbol	MUR140	MUR160	Unit
Peak Repetitive Reverse Voltage Working Peak Reverse Voltage DC Blocking Voltage	V <sub>RRM</sub> V <sub>RWM</sub> V <sub>R</sub>	400	600	V
RMS Reverse Voltage	V <sub>R(RMS)</sub>	283	424	V
Average Rectified Output Current @ T <sub>J</sub> = 120°C	I <sub>O</sub>	1.0		A
Non-Repetitive Peak Forward Surge Current 8.3ms Single half sine-wave Superimposed on Rated Load (JEDEC Method)	I <sub>FSM</sub>	35		A
Forward Voltage @ I <sub>F</sub> = 1.0A, T <sub>J</sub> = 25°C @ I <sub>F</sub> = 1.0A, T <sub>J</sub> = 150°C	V <sub>FM</sub>	1.25 1.05		V
Peak Reverse Current at Rated DC Blocking Voltage @ T <sub>A</sub> = 25°C @ T <sub>A</sub> = 150°C	I <sub>RM</sub>	5.0 150		μA
Reverse Recovery Time (Note 2)	t <sub>rr</sub>	50		ns
Reverse Recovery Time (Note 3)	t <sub>rr</sub>	75		ns
Forward Recovery Time (Note 4)	t <sub>fr</sub>	50		ns
Typical Junction Capacitance (Note 1)	C <sub>j</sub>	45		pF
Typical Thermal Resistance, Junction to Ambient	R <sub>θJA</sub>	72		K/W
Operating and Storage Temperature Range	T <sub>J</sub> , T <sub>STG</sub>	-65 to +175		°C

- Notes:
1. Measured at 1.0MHz and applied reverse voltage of 0V DC.
  2. Measured with I<sub>F</sub> = 0.5A, I<sub>R</sub> = 1.0A, I<sub>rr</sub> = 0.25A. See Figure 5.
  3. Measured with I<sub>F</sub> = 1A, di/dt = 50A/μs.
  4. Measured with I<sub>F</sub> = 1.0A, di/dt = 100A/μs, Duty Cycle ≤ 2.0%.
  5. RoHS revision 13.2.2003. Glass and High Temperature Solder Exemptions Applied, see *EU Directive Annex Notes 5 and 7*.

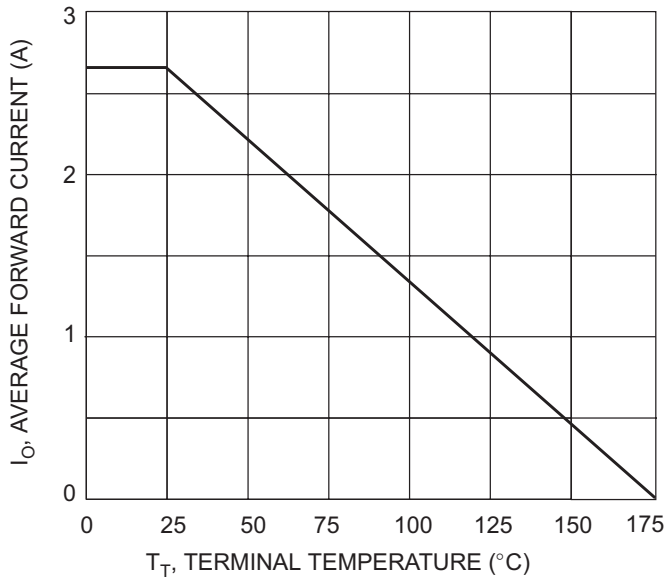

Fig. 1 Forward Current Derating Curve

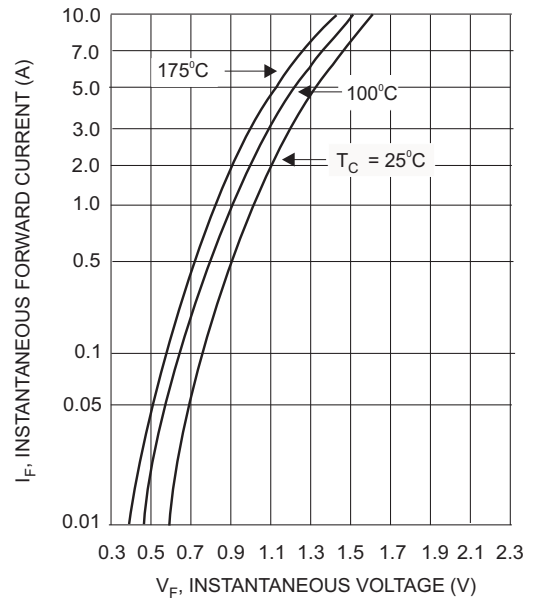

Fig. 2 Typical Forward Current

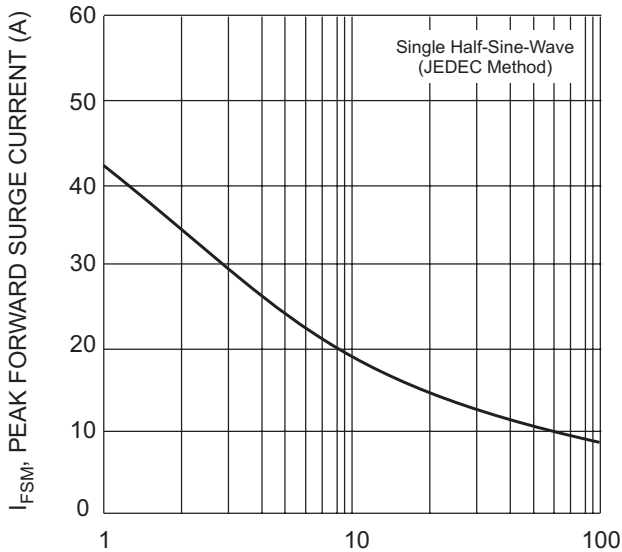

Fig. 3 Surge Current Derating Curve

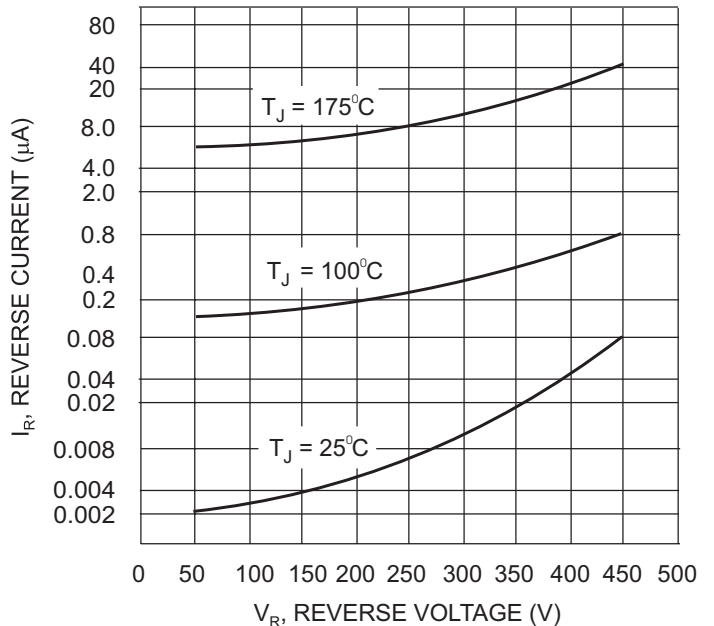
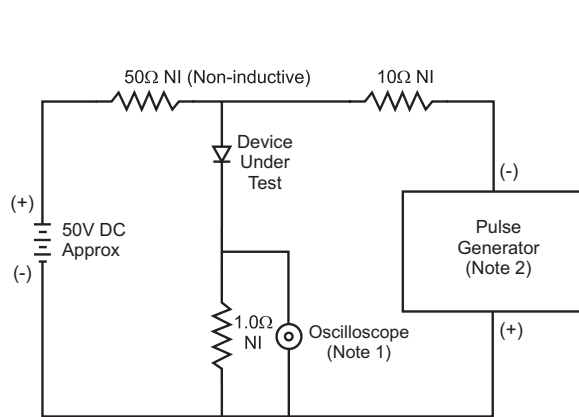
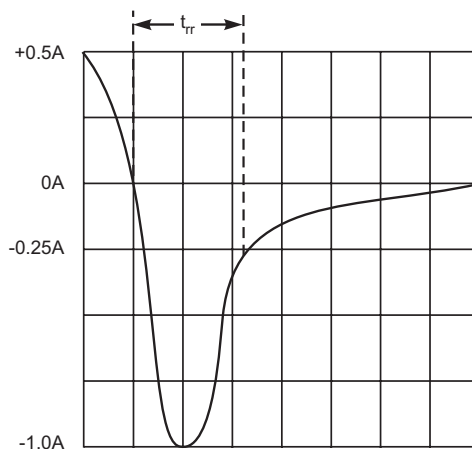

Fig. 4 Typical Reverse Current



- Notes:
1. Rise Time = 7.0ns max. Input Impedance = 1.0MΩ, 22pF.
  2. Rise Time = 10ns max. Input Impedance = 50Ω.



Set time base for 50/100 ns/cm

Fig. 5 Reverse Recovery Time Characteristic and Test Circuit

**Ordering Information** (Note 6)

<b>Device</b>	<b>Packaging</b>	<b>Shipping</b>
MUR140-A	DO-41	5K/Ammo Pack
MUR140-B	DO-41	1K/Bulk
MUR140-T	DO-41	5K/Tape & Reel, 13-inch
MUR160-A	DO-41	5K/Ammo Pack
MUR160-B	DO-41	1K/Bulk
MUR160-T	DO-41	5K/Tape & Reel, 13-inch

Notes: 6. For packaging details, visit our website at <http://www.diodes.com/datasheets/ap02008.pdf>

# AMEYA360

## Components Supply Platform

Authorized Distribution Brand :



Website :

Welcome to visit [www.ameya360.com](http://www.ameya360.com)

Contact Us :

➤ Address :

401 Building No.5, JiuGe Business Center, Lane 2301, Yishan Rd  
Minhang District, Shanghai , China

➤ Sales :

Direct +86 (21) 6401-6692

Email [amall@ameya360.com](mailto:amall@ameya360.com)

QQ 800077892

Skype [ameyasales1](#) [ameyasales2](#)

➤ Customer Service :

Email [service@ameya360.com](mailto:service@ameya360.com)

➤ Partnership :

Tel +86 (21) 64016692-8333

Email [mkt@ameya360.com](mailto:mkt@ameya360.com)