

# MAX4400–MAX4403

# Single/Dual/Quad, Low-Cost, Single-Supply, Rail-to-Rail Op Amps with Shutdown

## General Description

The MAX4400–MAX4403 low-cost, general-purpose op amps offer rail-to-rail outputs, draw only 320µA of quiescent current, and operate from a single +2.5V to +5.5V supply. For additional power conservation, the MAX4401 offers a low-power shutdown mode that reduces supply current to 1µA (max) and puts the amplifier's output in a high-impedance state. These devices deliver ±1.4mA of output current and are unity-gain stable with a 1MHz gain-bandwidth product driving capacitive loads up to 400pF. The MAX4400–MAX4403 are specified to +125°C, making them suitable for use in a variety of harsh environments, such as automotive applications.

The MAX4400 single amplifier is available in ultra-small 5-pin SC70 and space-saving 5-pin SOT23 packages. The single MAX4401 includes the shutdown feature and is available in a 6-pin SC70. The MAX4402 is a dual amplifier available in 8-pin SOT23, µMAX®, and SO packages. The MAX4403 quad amplifier is packaged in a 14-pin TSSOP or SO.

## Applications

- Single-Supply, Zero-Crossing Detectors
- Instruments and Terminals
- Portable Communications
- Electronic Ignition Modules
- Infrared Receivers
- Sensor Signal Detection

## Selector Guide

PART	NO. OF AMPLIFIERS PER PACKAGE	SHUTDOWN MODE
MAX4400	1	No
MAX4401	1	Yes
MAX4402	2	No
MAX4403	4	No

µMAX is a registered trademark of Maxim Integrated Products, Inc.

## Features

- Single +2.5V to +5.5V Supply Voltage Range
- 320µA Quiescent Current per Amplifier
- 1µA (max) Shutdown Mode (MAX4401)
- Available in Space-Saving Packages
  - 5-Pin SC70 (MAX4400)
  - 6-Pin SC70 (MAX4401)
  - 8-Pin SOT23/µMAX (MAX4402)
- 110dB A<sub>VOL</sub> with 2kΩ Load
- 0.015% THD with 2kΩ Load
- Rail-to-Rail Output Voltage Swing
- 1.4mA of Sink and Source Load Current
- Unity-Gain Stable up to C<sub>LOAD</sub> = 400pF
- Ground-Sensing Inputs

## Ordering Information

PART	TEMP RANGE	PIN-PACKAGE	TOP MARK
MAX4400AXK+T	-40°C to +125°C	5 SC70	AAG
MAX4400AUK+T	-40°C to +125°C	5 SOT23	ADNP
MAX4401AXT+T	-40°C to +125°C	6 SC70	AAB
MAX4402AKA+T	-40°C to +125°C	8 SOT23	AADI
MAX4402AKA/V+T	-40°C to +125°C	8 SOT23	AETR
MAX4402AUA+	-40°C to +125°C	8 µMAX	—
MAX4402AUA/V+T	-40°C to +125°C	8 µMAX	—
MAX4402ASA+	-40°C to +125°C	8 SO	—
MAX4403AUD+	-40°C to +125°C	14 TSSOP	—
MAX4403ASD+	-40°C to +125°C	14 SO	—

+Denotes a lead(Pb)-free/RoHS-compliant package.

/V denotes an automotive qualified part.

T = Tape and reel.

## Pin Configurations

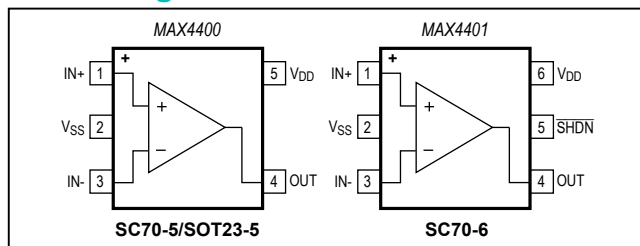

Pin Configurations continued at end of data sheet.

**Absolute Maximum Ratings**

Power-Supply Voltage ( $V_{DD}$ to $V_{SS}$ ).....	-0.3V to +6V	8-Pin $\mu$ MAX (derate 4.5mW/°C above +70°C).....	362mW
All Other Pins .....	( $V_{SS} - 0.3V$ ) to ( $V_{DD} + 0.3V$ )	8-Pin SO (derate 5.88mW/°C above +70°C).....	471mW
Output Short-Circuit Duration		14-Pin TSSOP (derate 8.33mW/°C above +70°C).....	667mW
OUT Shorted to $V_{SS}$ or $V_{DD}$ .....	Continuous	14-Pin SO (derate 8.33mW/°C above +70°C).....	667mW
Continuous Power Dissipation ( $T_A = +70^\circ\text{C}$ )		Operating Temperature Range.....	-40°C to +125°C
5-Pin SC70 (derate 2.5mW/°C above +70°C).....	200mW	Storage Temperature Range.....	-65°C to +150°C
5-Pin SOT23 (derate 7.1mW/°C above +70°C) .....	571mW	Lead Temperature (soldering, 10s) .....	+300°C
6-Pin SC70 (derate 2.27mW/°C above +70°C).....	181mW	Soldering Temperature (reflow) .....	+260°C
8-Pin SOT23 (derate 7.52mW/°C above +70°C) .....	602mW		

Stresses beyond those listed under "Absolute Maximum Ratings" may cause permanent damage to the device. These are stress ratings only, and functional operation of the device at these or any other conditions beyond those indicated in the operational sections of the specifications is not implied. Exposure to absolute maximum rating conditions for extended periods may affect device reliability.

**Electrical Characteristics**

( $V_{DD} = +5V$ ,  $V_{SS} = 0V$ ,  $V_{CM} = 0V$ ,  $V_{OUT} = V_{DD}/2$ ,  $R_L = \infty$  connected to  $V_{DD}/2$ ,  $\overline{SHDN} = V_{DD}$  (MAX4401 only),  $T_A = +25^\circ\text{C}$ , unless otherwise noted.)

PARAMETER	SYMBOL	CONDITIONS	MIN	TYP	MAX	UNITS
Supply Voltage Range	$V_{DD}$	Inferred from PSRR test	2.5		55	V
Supply Current per Amplifier	$I_{DD}$	$V_{DD} = 2.5V$		320		$\mu\text{A}$
		$V_{DD} = 5.0V$		410	700	
Supply Current in Shutdown	$I_{\overline{SHDN}}$	$\overline{SHDN} = V_{SS}$ (Note 1)		0.00002	1	$\mu\text{A}$
Input Offset Voltage	$V_{OS}$	MAX4400/MAX4401		$\pm 0.8$	$\pm 4.5$	mV
		MAX4402/MAX4403		$\pm 1.0$	$\pm 5.5$	
Input Bias Current	$I_B$	(Note 2)		$\pm 0.1$	$\pm 100$	pA
Input Offset Current	$I_{OS}$	(Note 2)		$\pm 0.1$	$\pm 100$	pA
Input Resistance	$R_{IN}$	Differential or common mode		1000		G $\Omega$
Input Common-Mode Voltage Range	$V_{CM}$	Inferred from CMRR test	$V_{SS}$		$V_{DD} - 1.4$	V
Common-Mode Rejection Ratio	CMRR	$V_{SS} \leq V_{CM} \leq V_{DD} - 1.4V$	68	84		dB
Power-Supply Rejection Ratio	PSRR	$2.5V \leq V_{DD} \leq 5.5V$	78	100		dB
Large-Signal Voltage Gain	$A_{VOL}$	$V_{SS} + 0.3V \leq V_{OUT} \leq V_{DD} - 0.3V$	$R_L = 100k\Omega$		120	dB
			$R_L = 2k\Omega$	90	110	
Output Voltage High	$V_{OH}$	Specified as $ V_{DD} - V_{OH} $	$R_L = 100k\Omega$		3	mV
			$R_L = 2k\Omega$	55	200	
Output Voltage Low	$V_{OL}$	Specified as $ V_{SS} - V_{OL} $	$R_L = 100k\Omega$		2	mV
			$R_L = 2k\Omega$	30	75	
Output Short-Circuit Current		Sourcing		12		mA
		Sinking		30		
Shutdown Mode Output Leakage	$I_{OUTSHDN}$	Device in shutdown mode, $\overline{SHDN} = V_{SS}$ , $V_{SS} < V_{OUT} < V_{CC}$ (Note 1)			$\pm 1.0$	$\mu\text{A}$
SHDN Logic Low	$V_{IL}$	(Note 1)			$0.3 \times V_{DD}$	V
SHDN Logic High	$V_{IH}$	(Note 1)	$0.7 \times V_{DD}$			V
SHDN Input Current	$I_{IL}, I_{IH}$	$\overline{SHDN} = V_{DD}$ or $V_{SS}$ (Note 1)		$\pm 0.001$	$\pm 500$	nA
Gain-Bandwidth Product	GBW			800		kHz
Phase Margin	$\phi_M$			70		degrees
Gain Margin				20		dB
Slew Rate	SR			1		V/ $\mu\text{s}$

**Electrical Characteristics (continued)**

( $V_{DD} = +5V$ ,  $V_{SS} = 0V$ ,  $V_{CM} = 0V$ ,  $V_{OUT} = V_{DD}/2$ ,  $R_L = \infty$  connected to  $V_{DD}/2$ ,  $\overline{SHDN} = V_{DD}$  (MAX4401 only),  $T_A = +25^\circ C$ , unless otherwise noted.)

PARAMETER	SYMBOL	CONDITIONS	MIN	TYP	MAX	UNITS
Input Voltage-Noise Density	$e_n$	$f = 10kHz$		36		nV/ $\sqrt{Hz}$
Input Current-Noise Density	$i_n$	$f = 10kHz$		1		fA/ $\sqrt{Hz}$
Capacitive-Load Stability	$C_{LOAD}$	$A_V = +1V/V$		400		pF
Shutdown Delay Time	$t_{SHDN}$	$A_V = +1V/V$		0.4		$\mu s$
Enable Delay Time	$t_{EN}$	(Note 1)		6		$\mu s$
Power-On Time	$t_{ON}$			5		$\mu s$
Input Capacitance	$C_{IN}$			2.5		pF
Total Harmonic Distortion	THD	$f = 10kHz$ , $V_{OUT} = 2V_{P-P}$ , $A_V = +1V/V$	$R_L = 100k\Omega$	0.009		%
			$R_L = 2k\Omega$	0.015		
Settling Time to 0.1%	$t_S$	$V_{OUT} = 2V$ step		7		$\mu s$

**Electrical Characteristics**

( $V_{DD} = +5V$ ,  $V_{SS} = 0V$ ,  $V_{CM} = 0V$ ,  $V_{OUT} = V_{DD}/2$ ,  $R_L = \infty$  connected to  $V_{DD}/2$ ,  $T_A = -40^\circ C$  to  $+125^\circ C$ , unless otherwise noted.) (Note 3)

PARAMETER	SYMBOL	CONDITIONS	MIN	TYP	MAX	UNITS
Supply Voltage Range	$V_{DD}$	Inferred by PSRR test	2.5		5.5	V
Supply Current per Amplifier	$I_{DD}$				800	$\mu A$
		MAX4400/MAX4401			$\pm 6.5$	
Input Offset Voltage	$V_{OS}$	MAX4402/MAX4403			$\pm 8.0$	mV
Input Offset Voltage Drift	$TC_{VOS}$			$\pm 1$		$\mu V/^\circ C$
Input Bias Current	$I_B$	(Note 2)			$\pm 100$	pA
Input Offset Current	$I_{OS}$	(Note 2)			$\pm 100$	pA
Input Common-Mode Voltage Range	$V_{CM}$	Inferred from CMRR test	$V_{SS}$	$V_{DD} - 1.5$		V
Common-Mode Rejection Ratio	CMRR	$V_{SS} \leq V_{CM} \leq V_{DD} - 1.5V$	65			dB
		$V_{SS} \leq V_{CM} \leq V_{DD} - 1.0V$ $T_A = -20^\circ C$ to $+125^\circ C$	50			
Power-Supply Rejection Ratio	PSRR	$2.5V \leq V_{CC} \leq 5.5V$	74			dB
Shutdown Mode Output Leakage	$I_{OUTSHDN}$	Device in shutdown mode, $\overline{SHDN} = V_{SS}$ , $V_{SS} < V_{OUT} < V_{DD}$ (Note 1)	$T_A = -40^\circ C$ to $+85^\circ C$		$\pm 1.0$	$\mu A$
			$T_A = +85^\circ C$ to $+125^\circ C$		$\pm 5.0$	
$\overline{SHDN}$ Logic Low	$V_{IL}$	(Note 1)		$0.3 \times V_{DD}$		V
$\overline{SHDN}$ Logic High	$V_{IH}$	(Note 1)	$0.7 \times V_{DD}$			V
$\overline{SHDN}$ Input Current	$I_{IL}$ , $I_{IH}$	$\overline{SHDN} = V_{DD}$ or $V_{SS}$ (Notes 1, 2)			$\pm 1000$	nA
Large-Signal Voltage Gain	$A_{VOL}$	$V_{SS} + 0.3V \leq V_{OUT} \leq V_{DD} - 0.3V$ , $R_L = 2k\Omega$	85			dB
Output Voltage High	$V_{OH}$	Specified as $ V_{DD} - V_{OH} $ , $R_L = 2k\Omega$			250	mV
Output Voltage Low	$V_{OL}$	Specified as $ V_{SS} - V_{OL} $ , $R_L = 2k\Omega$			100	mV

**Note 1:** Shutdown mode is only available in the 6-pin SC70 single op amp (MAX4401).

**Note 2:** Guaranteed by design.

**Note 3:** Specifications are 100% tested at  $T_A = +25^\circ C$  (exceptions noted). All temperature limits are guaranteed by design.

Typical Operating Characteristics

( $V_{DD} = +5V$ ,  $V_{SS} = 0V$ ,  $V_{CM} = V_{DD}/2$ ,  $V_{SHDN} = 5V$ ,  $R_L = \infty$  connected to  $V_{DD}/2$ ,  $T_A = +25^\circ C$ , unless otherwise noted.)

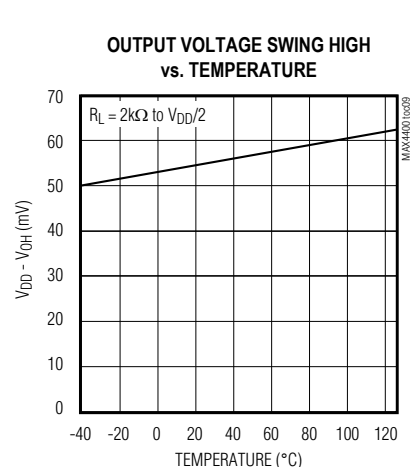
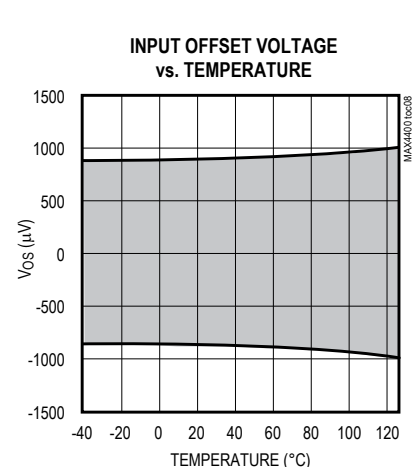
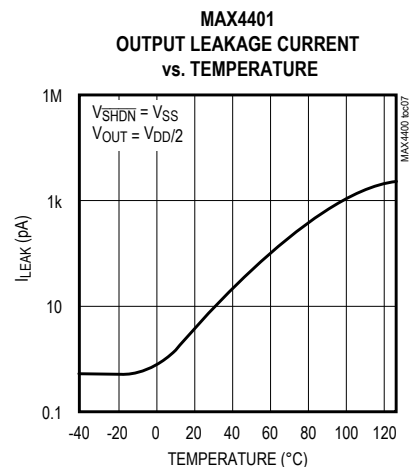
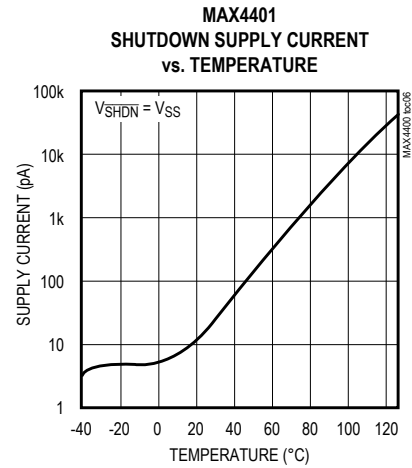
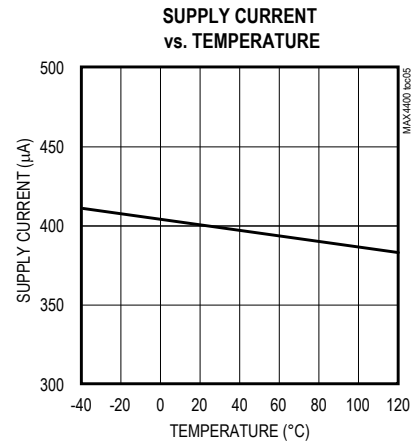
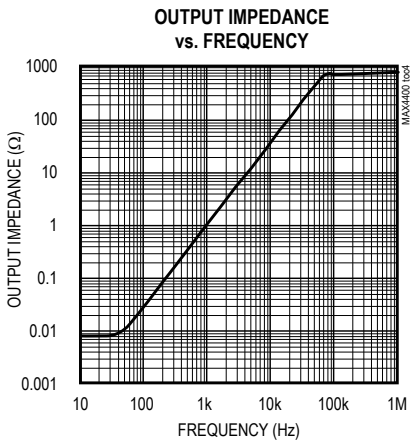
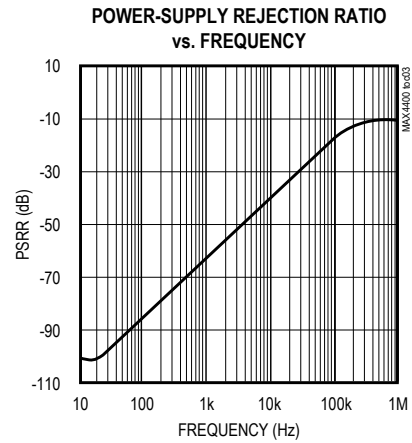
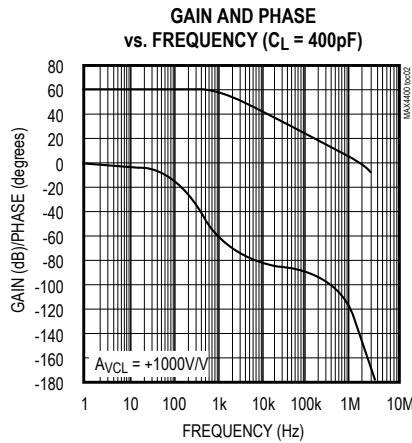
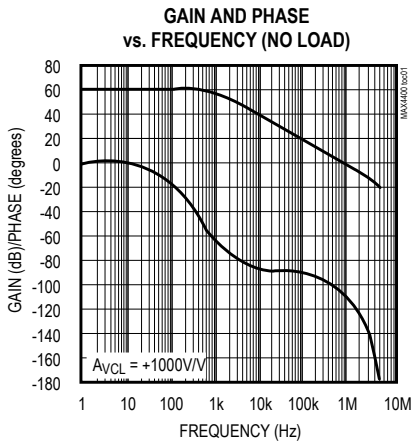

Typical Operating Characteristics (continued)

( $V_{DD} = +5V$ ,  $V_{SS} = 0V$ ,  $V_{CM} = V_{DD}/2$ ,  $V_{SHDN} = 5V$ ,  $R_L = \infty$  connected to  $V_{DD}/2$ ,  $T_A = +25^\circ C$ , unless otherwise noted.)

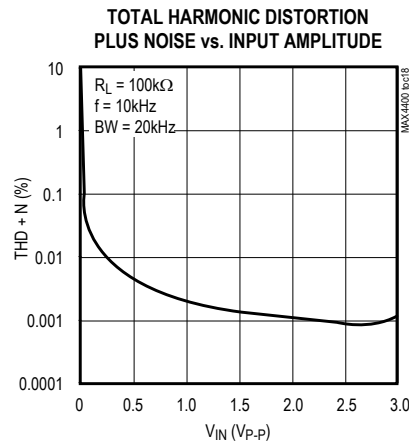
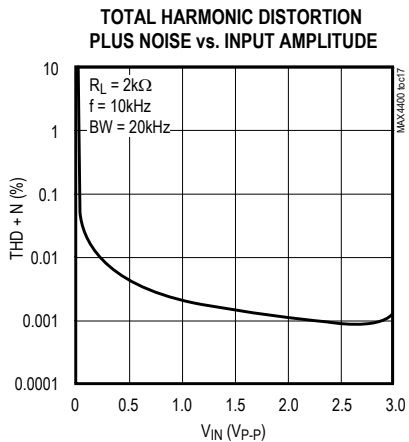
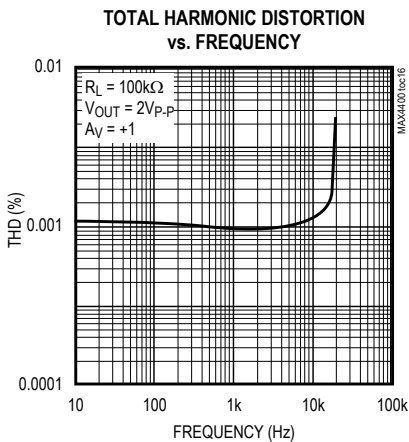
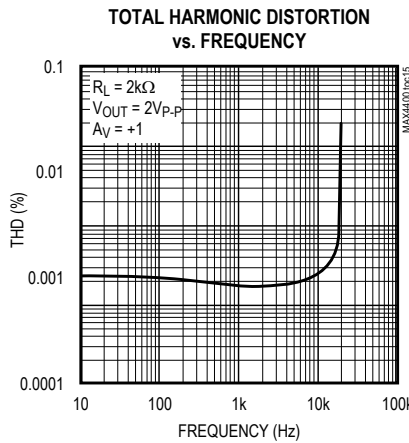
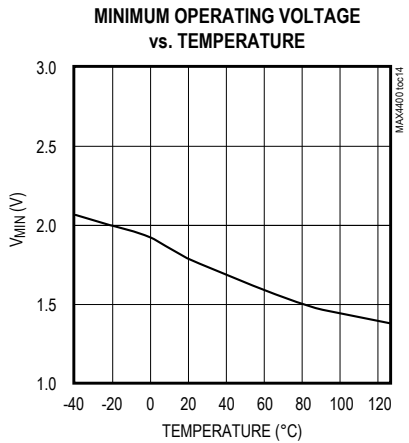
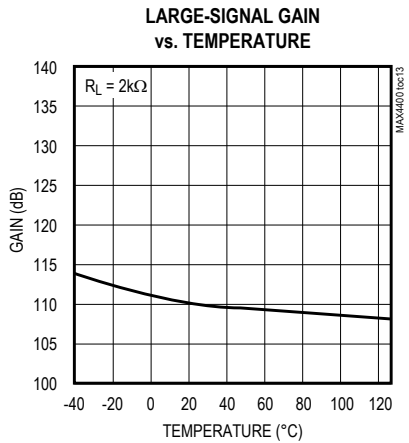
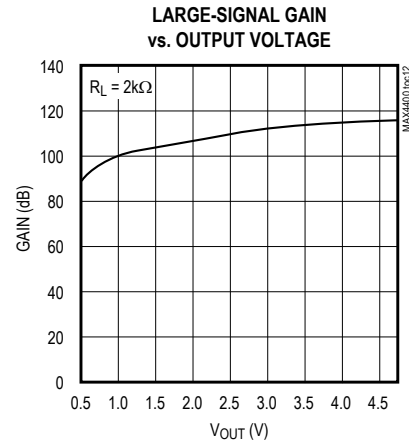
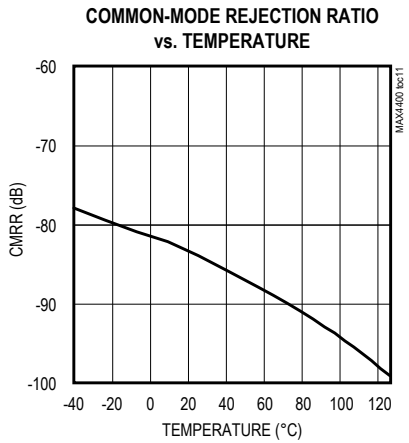
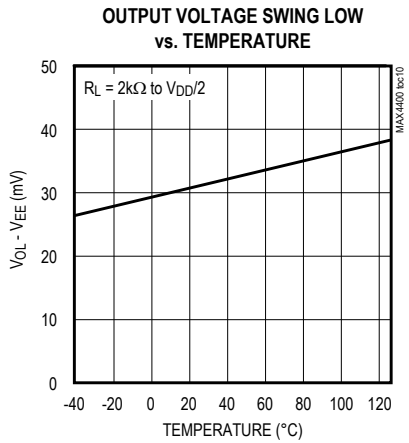

Typical Operating Characteristics (continued)

( $V_{DD} = +5V$ ,  $V_{SS} = 0V$ ,  $V_{CM} = V_{DD}/2$ ,  $V_{SHDN} = 5V$ ,  $R_L = \infty$  connected to  $V_{DD}/2$ ,  $T_A = +25^\circ C$ , unless otherwise noted.)

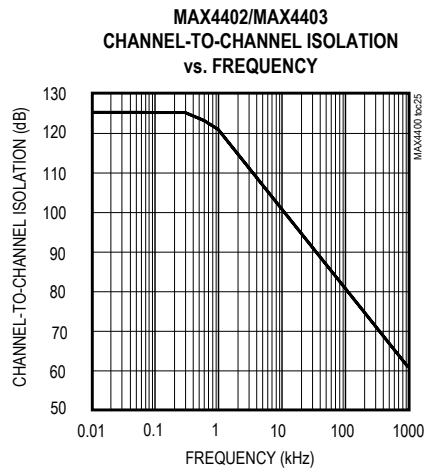
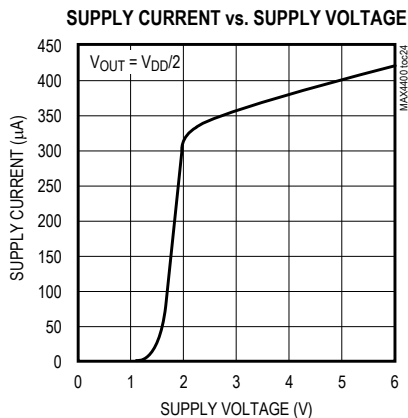
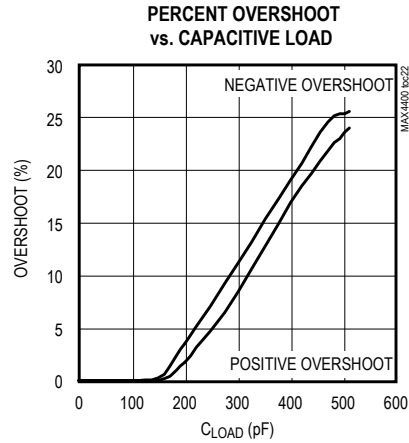
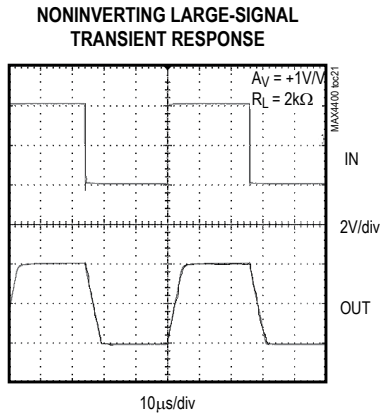
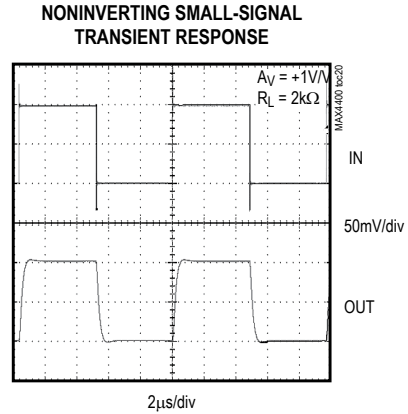
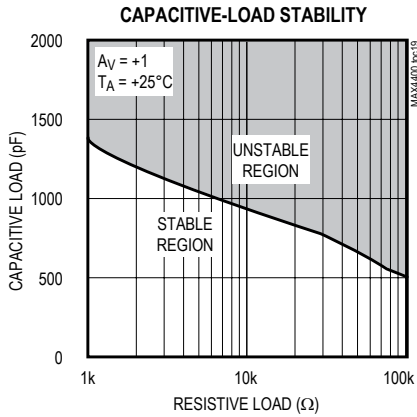

## Pin Description

PIN				NAME	FUNCTION
MAX4400	MAX4401	MAX4402	MAX4403		
1	1	—	—	IN+	Noninverting Amplifier Input
—	—	3	3	INA+	Noninverting Amplifier Input A
—	—	5	5	INB+	Noninverting Amplifier Input B
—	—	—	10	INC+	Noninverting Amplifier Input C
—	—	—	12	IND+	Noninverting Amplifier Input D
2	2	4	11	V <sub>SS</sub>	Negative Supply. Connect to ground for single-supply operation.
3	3	—	—	IN-	Inverting Amplifier Input
—	—	2	2	INA-	Inverting Amplifier Input A
—	—	6	6	INB-	Inverting Amplifier Input B
—	—	—	9	INC-	Inverting Amplifier Input C
—	—	—	13	IND-	Inverting Amplifier Input D
4	4	—	—	OUT	Amplifier Output
—	—	1	1	OUTA	Amplifier Output A
—	—	7	7	OUTB	Amplifier Output B
—	—	—	8	OUTC	Amplifier Output C
—	—	—	14	OUTD	Amplifier Output D
5	6	8	4	V <sub>DD</sub>	Positive Supply
—	5	—	—	$\overline{\text{SHDN}}$	Active-Low Shutdown Input. Connect to V <sub>DD</sub> for normal operation. Do not leave unconnected.

## Detailed Description

### Rail-to-Rail Output Stage

The MAX4400–MAX4403 can drive a 2k $\Omega$  load and still typically swing within 55mV of the supply rails. Figure 1 shows the output voltage swing of the MAX4400 configured with  $A_V = +10V/V$ .

### Driving Capacitive Loads

Driving a capacitive load can cause instability in many op amps, especially those with low quiescent current. The MAX4400–MAX4403 are unity-gain stable for a range of capacitive loads to above 400pF. Figure 2 shows the response of the MAX4400 with an excessive capacitive load. Adding a series resistor between the output and the load capacitor (Figure 3) improves the circuit's response by isolating the load capacitance from the op amp's output.

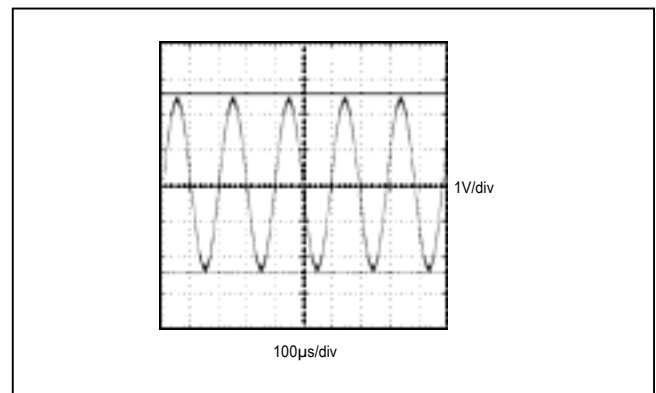

Figure 1. Rail-to-Rail Output Operation

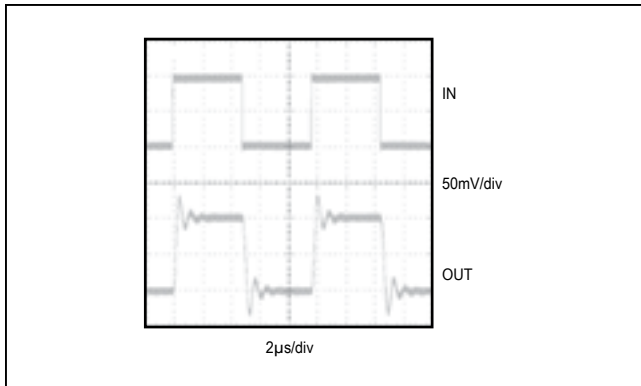

Figure 2. Small-Signal Transient Response with Excessive Capacitive Load

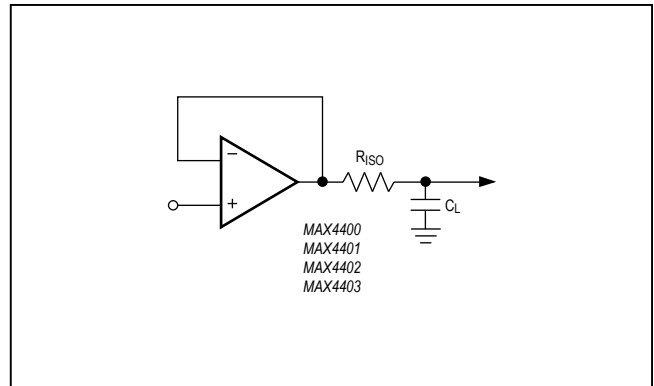

Figure 3. Capacitive-Load-Driving Circuit

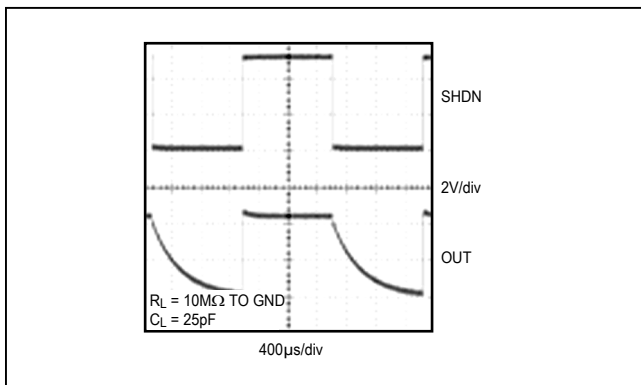

Figure 4. Shutdown Waveform

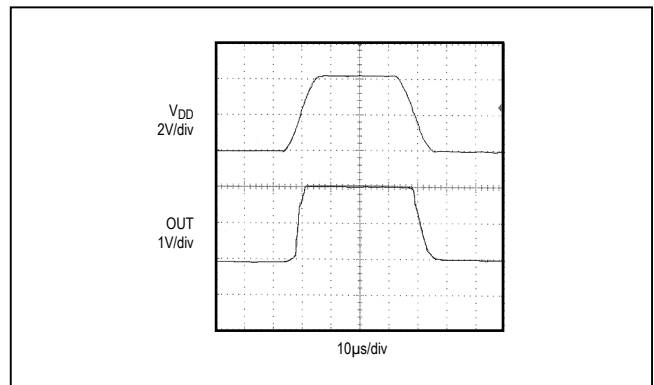

Figure 5. Power-Up/Power-Down Waveform

## Applications Information

### Shutdown Mode

The MAX4401 features a low-power shutdown mode. When  $\overline{\text{SHDN}}$  goes low, the supply current drops to 20pA (typ) and the output enters a high-impedance state. Pull  $\overline{\text{SHDN}}$  high to enable the amplifier. Do not leave  $\overline{\text{SHDN}}$  unconnected. Figure 4 shows the shutdown waveform.

### Power-Up

The MAX4400–MAX4403 outputs typically settle within 5μs after power-up. Figure 5 shows the output voltage on power-up and power-down.

## Power Supplies and Layout

The MAX4400–MAX4403 operate from a single +2.5V to +5.5V power supply. Bypass the power supply with a 0.1μF capacitor to ground.

Good layout techniques optimize performance by decreasing the amount of stray capacitance at the op amp's inputs and outputs. To decrease stray capacitance, minimize trace lengths by placing external components close to the op amp's pins.

Pin Configurations (continued)

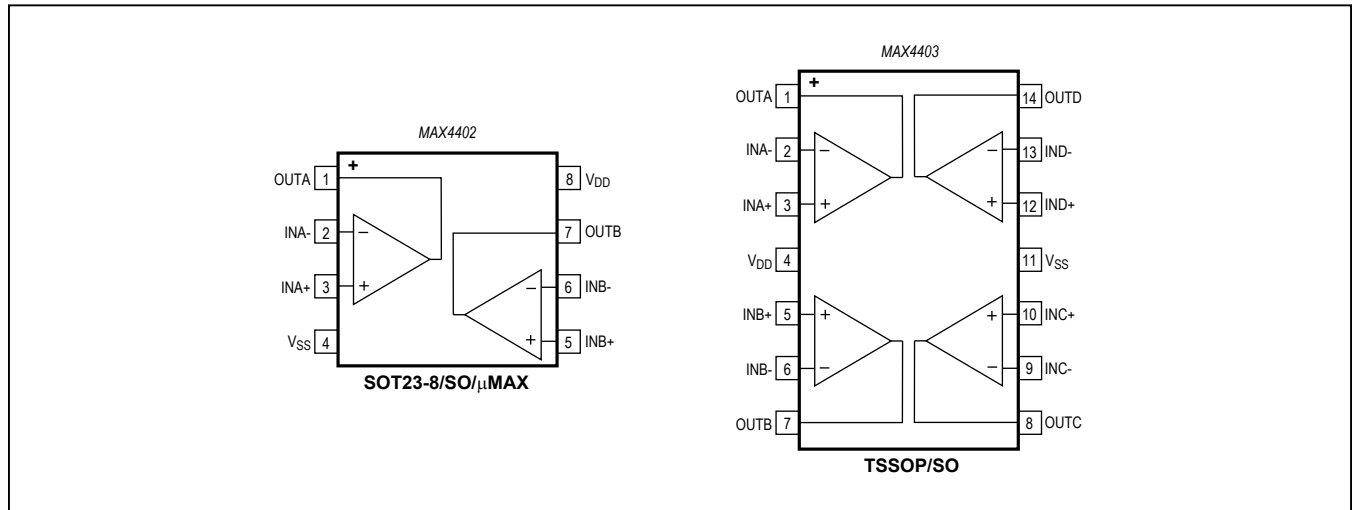

Package Information

For the latest package outline information and land patterns (footprints), go to [www.maximintegrated.com/packages](http://www.maximintegrated.com/packages). Note that a “+”, “#”, or “-” in the package code indicates RoHS status only. Package drawings may show a different suffix character, but the drawing pertains to the package regardless of RoHS status.

PACKAGE TYPE	PACKAGE CODE	OUTLINE NO.	LAND PATTERN NO.
5 SC70	X5+1	<a href="#">21-0076</a>	<a href="#">90-0188</a>
5 SOT23	U5+1	<a href="#">21-0057</a>	<a href="#">90-0174</a>
6 SC70	X6SN+1	<a href="#">21-0077</a>	<a href="#">90-0189</a>
8 SOT23	K8+5	<a href="#">21-0078</a>	<a href="#">90-0176</a>
8 μMAX	U8+1	<a href="#">21-0036</a>	<a href="#">90-0092</a>
8 SO	S8+2	<a href="#">21-0041</a>	<a href="#">90-0096</a>
14 TSSOP	U14+1	<a href="#">21-0066</a>	<a href="#">90-0113</a>
14 SO	S14+1	<a href="#">21-0041</a>	<a href="#">90-0112</a>

## Revision History

REVISION NUMBER	REVISION DATE	DESCRIPTION	PAGES CHANGED
0	1/00	Initial Release	—
1	11/00	Release of MAX4402.	1, 2, 9
2	7/00	Release of MAX4403.	1, 6, 7
3	9/01	Added $\mu$ MAX package to data sheet.	1, 2, 9
4	7/12	Added automotive package for MAX4402 to data sheet.	1
5	6/14	Added MAX4402AKA/V+T automotive package to data sheet.	1

For pricing, delivery, and ordering information, please contact Maxim Direct at 1-888-629-4642, or visit Maxim Integrated's website at [www.maximintegrated.com](http://www.maximintegrated.com).

*Maxim Integrated cannot assume responsibility for use of any circuitry other than circuitry entirely embodied in a Maxim Integrated product. No circuit patent licenses are implied. Maxim Integrated reserves the right to change the circuitry and specifications without notice at any time. The parametric values (min and max limits) shown in the Electrical Characteristics table are guaranteed. Other parametric values quoted in this data sheet are provided for guidance.*

# AMEYA360

## Components Supply Platform

Authorized Distribution Brand :



Website :

Welcome to visit [www.ameya360.com](http://www.ameya360.com)

Contact Us :

➤ Address :

401 Building No.5, JiuGe Business Center, Lane 2301, Yishan Rd  
Minhang District, Shanghai , China

➤ Sales :

Direct +86 (21) 6401-6692

Email [amall@ameya360.com](mailto:amall@ameya360.com)

QQ 800077892

Skype [ameyasales1](#) [ameyasales2](#)

➤ Customer Service :

Email [service@ameya360.com](mailto:service@ameya360.com)

➤ Partnership :

Tel +86 (21) 64016692-8333

Email [mkt@ameya360.com](mailto:mkt@ameya360.com)